

OFF ROAD / QUAD-ATV / UTV

2017 / 2018



 **Impnesa**

www.impnesa.com

Usuario:

Clave:

HORARIO RECEPCIÓN Y ENTREGA DE PEDIDOS:

Todos los pedidos están sujetos al servicio de 24h
(48h dependiendo de la zona y fluidez de transporte de vuestra población)
Los pedidos efectuados de 9:00 a 14:00 h. La recogida se realiza a las 15:00 h.
Los pedidos efectuados de 15:00 a 18:00 h. (a partir de las 17:00 h no siempre está garantizado su envío), se efectuará su recogida a las 18:00 h.



Ventas

Toni Pulido
Queralt Pich
Ana Izquierdo

International sales

Ana Izquierdo

Consultas técnicas

Eduard Tarrés (Quad - UTV)
Toni Pulido (MX - Enduro)

Contabilidad y créditos

Marta Ortega

Dirección

C/ Narcís Monturiol, 3
Pol. Ind. Bufalvent
08243 Manresa (Barcelona)

Teléfono de contacto

(+34) 938 771 550

E-mail

pedidos@impnesa.com
commandes@impnesa.fr



Tarifa válida a partir del 1 de Abril de 2017.

Precios de venta al público en euros, I.V.A. y tasas de reciclaje no incluidas.

Todos los precios y datos se consideran correctos salvo posible error de imprenta. Los precios pueden cambiar sin previo aviso. Utilicen la web para confirmación.



Tarif valable à partir du 1er avril 2017.

Prix de vente au public en euros. TVA non comprise.

Tous les prix et informations sont considérés corrects sauf possible erreur d'impression. Les prix peuvent changer sans préavis. Utilisez le site web pour confirmation.

ÍNDICE **SECTORIAL**

MX / ENDURO		MX / ENDURO
Ruedas y neumáticos	8	Roues et pneus
Motor	17	Moteur
Admisión / Escape / Refrigeración	47	Admission / Échappement / Réfrigération
Eléctrico	63	Électrique
Suspensión / Dirección	75	Suspension / Direction
Frenos	83	Freins
Transmisión	99	Transmission
Controles y Mandos	109	Contrôles et commandes
Chasis	131	Châssis
QUAD / ATV / UTV		QUAD / ATV / UTV
Ruedas y neumáticos	139	Roues et pneus
Motor	157	Moteur
Admisión / Escape / Refrigeración	177	Admission / Échappement / Réfrigération
Eléctrico	191	Électrique
Suspensión / Dirección	211	Suspension / Direction
Frenos	223	Freins
Transmisión	233	Transmission
Controles y Mandos	259	Contrôles et commandes
Chasis	267	Châssis
Accesorios y Equipamientos	279	Accessoires et équipement

ÍNDICE MX / ENDURO

Acelerador aluminio	112	Grifos gasolina	51	MX Top Gear	9
Aflojafiltros	44	Interruptor bomba gasolina	72	Palanca neumáticos	10
Agarre cubierta	10	Interruptor de embrague	71	Paramanos	110
Ajustador válvula escape 2t KTM	41	Interruptor de freno	71	Pastillas de freno	84-93
Alargo guardabarros led	74	Interruptores	71	Pastillas de reglaje	33
Alicates plato embrague	41	Interruptores de arranque	72	Patinador de cadena	107
Asientos completos / fundas	138	Interruptores de paro	73	Pedales de arranque	126-127
Baterías	64-65	Juego conectores	73	Pedales de cambio	128-130
Bielas completas	34-36	Juntas Cilindro Cometic	18	Piñones	100-104
Bobina encendido	68	Juntas de cilindro Namura	19-27	Pipa de bujía con resistencia	69
Bolas testigo depósito gasolina	52	Juntas de embrague	40	Pipas de bujía	70
Brida tubo gasolina	51	Juntas de escape	58-59	Pit Cross	9
Bujías NGK	70	Juntas de estátor	68	Portachiclés	52
Cables acelerador / embrague	114-115	Juntas de motor Namura	19-27	Probetas medidoras líquido	52
Cadenas con/sin retenes	105	Kit bomba de agua Honda CRF450	46	Protector aluminio cárter	132-134
Caja de pastillas de reglaje	33	Kit de cilindro	29	Protector de cadena	107-108
Calefacción manos	110	Kit de reparación carburador	49	Protector de horquilla neopreno	82
Cámaras de aire reforzadas	10	Kit de reparación dirección	76-77	Protector de llanta	10
Cañas acelerador	113	Kit discos de embrague	38-39	Protector disco freno trasero	98
Cargador batería	66-67	Kit funda para radios	12	Protector pedal freno trasero	129
Centrador de cámara	10	Kit pistón CP Pistons	18	Protector piñón	108
Chiclés carburador	48	Kit pistón Namura	19-27	Protector radiador	135-137
Cigüeñales completos	37	Kit reparación basculante	80-81	Protector tapa de embrague	41
Cilindros	28	Kit reparación bieleta	79	Puños	111
Cojinetes ruedas	13-16	Kit reparación bomba de freno	96-97	Radiadores	60-62
Compresor de válvulas	41	Kit reparación casquillos amort.	78	Radial Llanta	11
Conector rápido gasolina	51	Kit reparación de cables	113	Regulador de corriente	69
Conmutador luces	72	Kit reparación escobillas	69	Rejas protección radiador	62
Control de horquilla	82	Kit retenes bomba de agua	46	Relés de arranque	74
Coronas	100-104	Kit retenes motor	37	Reparador válvula llanta	10
Depósito gasolina portátil	52	Kit tornillos disco de freno	95	Rodillos cadena	106
Desmultiplicador embrague	113	Láminas de admisión	50	Saca muelles	52
Destalonador de neumáticos	10	Limitador de velocidad y RPM	74	Sangrador de freno	98
Destornillador curvo	52	Limpiador de cadena	106	Sangradores de horquilla	82
Difusor temperatura radiador	62	Limpiador de chiclés	49	Segmentos	19-27
Discos de freno	94-95	Llave para radios	10 / 12	Separador de pistón pinza freno	98
Disipador temperatura freno	98	Llave para radios	12	Soporte de maneta embrague	116
Donuts	111	Mando acelerador	112	Talonador de neumáticos	10
Elevadores manillar	111	Manetas fundición freno/embrague	119-125	Tapón drenaje imantado	45
Embudos	52	Manetas plegables freno/embrague	117-118	Tapón llenado aceite	45
Estátor	68	Manillares	110	Tapón silencioso	52
Extractor de bulón	41	Mini corta cadenas	106	Toma corriente	74
Extractor de chiclés	49	Monta válvulas	10	Tornillo regulación aire	50
Faros halógenos	74	Montador de válvulas	41	Tubo gasolina NBR	51
Fibra silencioso	52	Motor de arranque	69	Tubos de escape GPR	53-57
Filtro de gasolina	51	Muelles para colectores y silenciosos	52	Útil zapatas embrague KTM	41
Filtros de aceite	42-44	Muelles válvulas racing	32	Válvula tapón gasolina	51
Filtros de aire universales	50	MX Enduro / Superenduro	9	Válvulas admisión / escape racing	30
Galgas chiclés	49	MX Super X'Gear	9	Varilla manillar	111

ÍNDICE QUAD / ATV / UTV

Aceleradores puño/gatillo	263	Bendix Polaris	199	Cables acelerador/embrague	264-265
Adaptador filtro potencia	183	Bielas completas	170-171	Cables batería	210
Adaptador regulador Can Am	204	Bieleta amortiguador delantero	222	Cadenas	234-235
All Trail	143	Banshee		Caja pastillas de reglaje	169
Anclaje pala de nieve	283	Blackwater Evolution	143	Calefacción de manos y gatillo	262
AT 489	142	Bobina de encendido	200	Campana variador J.Costa	242
Baja Cross	145	Brida tubo gasolina	181	Candados	280
Baja Cross Sport	145	Bridas fuelle	255	Cardan completo	258
Bandeja de carga ATV	281	Bujes completos	236	Cargador Batería BC	195-197
Banderín	282	Bujías NGK	201	Cargas CO2	151
Baterías	192-194	Bulón variador J.Costa	242	Casquillo variador	239

Casquillo variador J.Costa	242	Kit cojinetes ruedas /eje	152-153	Radiadores	189
Casquillos eje Xpeed	237	Kit contrapesos variador Polaris	241	Redes elásticas	280
Casquillos embrague Polaris	240	Kit de reparación carburador	179	Regulador de corriente	202-203
Casquillos trapecios Yamaha	218	Kit de trabajo cabestrante	282	Regulador de corriente universal	204
Catadriópticos	208	Kit de transmisión	236	Rejas protección radiador	190
Chiclés carburador	178	Kit discos de embrague	172	Relé intermitencia	208
Cigüeñal completo	171	Kit escobillas standard	199	Relés arranque	206
Clausor	209	Kit pistón CP Pistons	158	Remaches cadena	235
Claxon	208	Kit pistón Namura	159-164	Remaches plástico	272
Clips cadena	235	Kit placas de fricción	172	Retenes de válvula	168
Codos unión manguitos radiador	188	Kit reparación basculante	213	Retenes motor	171
Columna dirección	212	Kit reparación bieleta	213	Retrovisores	209
Conector rápido gasolina	181	Kit reparación bomba freno delantera	232	Rodillos cadena	236
Conmutadores	206	Kit reparación brazo basculante trasero	222	Rodillos embrague	239
Coronas	234	Kit reparación cable embrague / acelerador	262	Rodillos variador	239
Correas	280	Kit reparación dirección	212	Rótulas barra estabilizadora	217
Correas variador	238	Kit reparación escobillas	198-199	Rótulas dirección	214-215
Cruceta de sujeción corona	237	Kit reparación pinza de freno	231	Rótulas trapecios	216-217
Crucetas cardan	244-247	Kit reparación variador Can AM	241	Sacamuelles	188
Cuchillo Cuter	280	Kit reparación variador Polaris	241	Segmentos	159-164
Deflector YXZ1000 R	278	Kit reparapinchazos	151	Sellador	151
Desconectores	262	Kit retenes grupo diferencial	258	Sensor temperatura	189
Desmultiplicador embrague	262	Kit soporte columna dirección	213	Separadores aluminio	154-155
Destornillador curvo	180	Knobby Gear	142	Separadores nilón	156
Difusor temperatura radiador	190	Land Hawk	142	Separadores universales	156
Discos de freno	230	Limitador velocidad y RPM	210	Separadores UTV	275-278
Discos velocidad	208	Limpiador chiclés	181	Sierra plegable	280
Ejes de tracción	237	Llantas	147-149	Soporte cardan	257
Elevadores de manillar	261	Luces químicas	280	Soporte manillar	212
Empuñaduras	263	Maleta ATV	281	Soporte ópticas/intermitentes/piloto stop	208
Eslinga de arrastre	280	Manetas embrague / freno	266	Soporte pala de nieve	282
Extractor de chiclés	180	Manillares	261	Speed Gear	141
Faros halógenos	210	Masas variador J.Costa	242	Tapabujes	146
Fibra silencioso	188	Mini compresor de viaje	151	Tapón gasolina	181
Filtro de gasolina	181	Mini cortacadenas	236	Tapón gasolina con llave	181
Filtros de aceite	174-176	Minipala multiuso	280	Tapón silencioso	188
Filtros de aire	182-183	Motor arranque	198-199	Tapones aluminio	151
Filtros de potencia	183	Mud Gear	144	Tensores de brida	255
fuelle universal+cono montaje	255	Mud Lite AT / XL	144	Termocontactos ventilador	190
Fuelles palier	254-257	Mud Lite XTR	142	Terracross R/T	143
Funda de bujía	199	Ópticas homologadas	207	Testigos luces	209
Fundas Asiento	268	Palas de nieve	282-283	Tobera admisión	180
Gafas Mx/Enduro/ATV	281	Palier completo	248-251	Toma corriente	210
Galgas chiclés	180	Parabrisas	282	Tope goma amortiguador	222
Gomas sujeción capó	272	Paramanos	260	Tornillo regulación aire	180
Grifos gasolina	180	Pastillas de freno	224-229	Tornillos recambio separadores	155
Guía rampa embrague Polaris	241	Pastillas de reglaje	169	Trail Wolf	142
Holeshot ATR	142	Pastillas variador Polaris	239	Tubo gasolina NBR	181
Holeshot GNCC	140	Perno embrague arrancador Polaris	241	Tubos de escape GPR	184-185
Holeshot MXR 4 / MXR 6	140	Petate hermético	280	Tuerca central eje	237
Holeshot SR	140	Pickup	204	Tuercas antirrobo	146
Holeshot SX	140	Pilotos/Tulipas homologados	207	Tuercas eje Xpeed	237
Holeshot XCR	140	Piñones	234	Tuercas llantas	146
Holeshot XCT	140	Pipas de bujía	199	Tundra Cross	142
Intermitentes homologados	207	Power Gear	141	Turf Tamer	141
Interruptor de freno	208	Power Gear Enduro	141	Ultra Cross	145
Interruptores	210	Protector varilla manillar	261	Válvula tapón gasolina	181
Juntas Cilindro	159-164	Protectores aluminio ATV	273	Válvulas admisión / escape	166-167
Juntas Cilindro Cometic	158	Protectores aluminio Quad deportivo	269-270	Válvulas aguja de carburador	179
Juntas colector / escape	186-187	Protectores aluminio UTV	275-278	Válvulas cámaras	146
Juntas de embrague o variador	173	Protectores PEHD Quad deportivo	270	Variadores J.Costa	243
Juntas estátor	205	Pulpos	280	Varilla manillar	261
Juntas Motor	159-164	Punteras completas	252-253	X-100	141
Kit casquillos buje trasero	222	Quad Cross MX Pro	140	X-500	142
Kit casquillos Polaris	219	Quad Cross XC	140	Xtrem Lite	143
Kit casquillos trapecios delanteros	218	Racer	141		
Kit casquillos trapecios y buje Polaris	220-221	Radiador calefacción UTV	210		
Kit casquillos trapecios y buje trasero	222				
Kit cilindro con aumento cilindrada	165				

INDEX MX / ENDURO

Ajusteur de valve	41	Extension garde-boue led	74	Pédales de recharge	128-130
Ajusteur de valves	10	Extracteur d'injecteurs	49	Phares halogènes	74
Antiparasite	70	Extracteur de roulement hydraulique	41	Pignons	100-104
Antiparasite avec résistance	69	Fibre silencieux	52	Pincés étau embrayage	41
Barillet de gaz	113	Filtre à carburant	51	Pit Cross	9
Batteries	64-65	Filtres à air universels	50	Plaquettes de frein	84-93
Bielles complètes	34-36	Filtres à huile	42-44	Poignée d'accélérateur aluminium	112
Bobine d'allumage	68	Gicleurs carburateur	48	Poignées	111
Boîte de pastilles de réglage	33	Grille de radiateur	62	Porte gicleur	52
Bouchon de remplissage d'huile	45	Gripster de roue	10	Prise de courant	74
Bouchon de vidange aimanté	45	Guidons	110	Protection carter en aluminium	132-134
Bouchon silencieux	52	Indicateur de niveau de carburant	52	Protection de carter d'embrayage	41
Bougies NGK	70	Jauges pour gicleurs	49	Protection de fourche en néoprène	82
Câbles d'accélérateur/embrayage	114-115	Jeux de connecteurs câblés	73	Protection de jante	10
Chaînes avec/sans joints	105	Joint de carter	68	Protection disque de frein arrière	98
Chambre à air renforcée	10	Joints de cylindre Cometic	18	Protection pédale de frein arrière	129
Chargeur pour batterie	66-67	Joints de cylindre Namura	19-27	Protection pignon	108
Chauffe mains	110	Joints d'échappement	58-59	Protection pour chaîne	107-108
Clapets d'admission	50	Joints embrayage	40	Protection radiateur	135-137
Clé à rayons	10 / 12	Joints moteur Namura	19-27	Protège poignée donuts	111
Clé à rayons	12	Kit de cylindres	29	Protèges mains	110
Clé à valve	10	Kit de piston Namura	19-27	Purgeur de frein	98
Clé pour filtre à huile	44	Kit de pistons CP	18	Purgeurs de fourche	82
Collier de durite d'essence	51	Kit de réparation carburateur	49	Raccord rapide essence	51
Commande d'accélérateur	112	Kit de réparation de balais	69	Radiateurs	60-62
Commutateur d'embrayage	71	Kit de réparation de biellette de direction	79	Rayons jante	11
Commutateur de démarrage	72	Kit de réparation de bras oscillant	80-81	Régulateur de vitesse et tr/min	74
Commutateur de frein	71	Kit de réparation de direction	76-77	Rélais de démarreur	74
Commutateur de lumières	72	Kit de réparation d'entretoises amortisseur	78	Réservoir à essence portable	52
Commutateur pompe à carburant	72	Kit de réparation pompe à frein	96-97	Ressort de valve Racing	32
Commutateurs	71	Kit de réparation pour câbles	113	Ressorts pour collecteurs et silencieux	52
Compresseur de ressorts de soupape	41	Kit de vis pour disques de frein	95	Robinet essence	51
Coupe-circuit	73	Kit disques d'embrayage	38-39	Rouleaux chaîne	106
Couronnes	100-104	Kit joints moteur	37	Roulements de roues	13-16
Couvres rayons	12	Kit joints pompe à eau	46	Segments	19-27
Crochets de ressorts	52	Kit pompe à eau Honda CRF450	46	Selles complètes/coques	138
Cylindres	28	Leviers de frein/d'embrayage en fonte	119-125	Séparateur piston étrier de frein	98
Démarrage moteur	69	Leviers de frein/d'embrayage pliables	117-118	Silent bloc soupape d'échappement 2T	41
Démonte-pneu	10	Mâchoires d'embrayage KTM	41	KTM	
Détalonneur de pneumatiques	10	Mini coupe chaînes	106	Soupape d'admission/d'échappement	30
Détalonneur de pneumatiques	10	Mousse pour guidon	111	Racing	
Diffuseur de chaleur pour radiateur	62	MX Enduro / Superenduro	9	Stator	68
Dispositif de centrage d'appareil photo	10	MX Super X'Gear	9	Support de levier d'embrayage	116
Disques de frein	94-95	MX Top Gear	9	Testeur de courant	69
Dissipateur thermique frein	98	Nettoyeur de chaîne	106	Tournevis courbé	52
Durite d'essence NBR	51	Nettoyeur de gicleurs	49	Tuyaux d'échappement GPR	53-57
Easy clutch	113	Pastilles de réglage	33	Vanne bouchon réservoir de carburant	51
Élévateurs de guidon	111	Patin de chaîne	107	Vérification fourche	82
Entonnoirs	52	Pédales de démarrage	126-127	Vilebrequins complets	37
Éprouvettes graduées	52			Vis d'air	50

INDEX QUAD / ATV / VTT

Adaptateur filtre de puissance	183	Bielles complètes	170-171	Bouchons en aluminium	151
Adaptateur régulateur Can Am	204	Biellette d'amortisseur avant	222	Bougies NGK	201
All Trail	143	Banshee		Boulon d'embrayage de démarrage	241
Antiparasite	199	Blackwater Evolution	143	Polaris	
AT 489	142	Bobine d'allumage	200	Boulon variateur J.Costa	242
Attache capot en caoutchouc	272	Boîte de pastilles de réglage	169	Câbles d'accélérateur / embrayage	264-265
Attache rapide chaîne moto	235	Bombe anti-crevaisson	151	Câbles pour batterie	210
Baja Cross	145	Bouchon d'essence	181	Cadenas	280
Baja Cross Sport	145	Bouchon d'essence à clé	181	Captur de température	189
Batteries	192-194	Bouchon réservoir à vanne	181	Cardan complet	258
Bendix Polaris	199	Bouchon silencieux	188	Centrale clignotant	208
				Chaînes	234-235

Chargeur pour batterie BC	195-197
Chauffage des mains et levier	262
Clausor	209
Clignotants homologués	207
Cloche variateur J.Costa	242
Collier de durite d'essence	181
Colliers soufflets	255
Colliers tendeurs	255
Colonne de direction	212
Commutateur de frein	208
Commutateurs	206
Commutateurs	210
Coques de selles	268
Coudes de raccord au radiateur	188
Coupe-circuit	262
Couronnes	234
Courroies	280
Courroies Variateur	238
Couvercles des moyeux	146
Crochets de ressorts	188
Cutter	280
Défecteur XYZ1000R	278
Démarrage moteur	198-199
Diffuseur de chaleur pour radiateur	190
Dispositifs rétroréfléchissants	208
Disques de frein	230
Disques de vitesse	208
Douille variateur	239
Douilles d'embrayage Polaris	240
Douilles variateur J.Costa	242
Durite d'essence NBR	181
Durite protégée bougie	199
Easy clutch	262
Écrou central essieu	237
Écrous antivol	146
Écrous de cardan	244-247
Écrous jantes	146
Écrous pour essieu Xpeed	237
Élévateurs de guidon	261
Ensemble de pointes	252-253
Entretoises pour essieu Xpeed	237
Entretoises triangle Yamaha	218
Essieux de traction	237
Extracteur d'injecteurs	180
Fanion	282
Fibre silencieux	188
Filtre à air	182-183
Filtre à carburant	181
Filtre de puissance	183
Filtres à huile	174-176
Fixation pelle à neige	283
Galets de Variateur	239
Galets d'embrayage	239
Gicleurs carburateur	178
Grille de radiateur	190
Guide rampes d'embrayage Polaris	241
Guidons	261
Holeshot ATR	142
Holeshot GNCC	140
Holeshot MXR 4 / MXR 6	140
Holeshot SR	140
Holeshot SX	140
Holeshot XCR	140
Holeshot XCT	140
Jantes	147-149
Jauges pour gicleurs	180
Joint de carter	205
Joints d'embrayage ou de variateur	173
Joints de collecteur/d'échappement	186-187

Joints de cylindre	159-164
Joints de cylindre Cometic	158
Joints de valve	168
Joints moteur	159-164
Joints moteur	171
Kit balais standard	199
Kit contrepoids variateur Polaris	241
Kit de cylindre avec augmentation de la cylindrée	165
Kit de joints groupe différentiel	258
Kit de piston Namura	159-164
Kit de pistons CP	158
Kit de réparation biellette de direction	213
Kit de réparation bras oscillant	213
Kit de réparation bras oscillant arrière	222
Kit de réparation câble d'embrayage / accélérateur	262
Kit de réparation carburateur	179
Kit de réparation de balais	198-199
Kit de réparation direction	212
Kit de réparation pince de frein	231
Kit de réparation pompe de frein avant	232
Kit de réparation variateur Can Am	241
Kit de réparation variateur Polaris	241
Kit de roulements de roues/essieux	152-153
Kit de soutien colonne de direction	213
Kit de transmission	236
Kit de travail au cabestan	282
Kit d'entretoises triangle avant	218
Kit disques d'embrayage	172
Kit entretoises moyeu arrière	222
Kit entretoises Polaris	219
Kit entretoises triangles et moyeu arrière	222
Kit entretoises triangles et moyeu Polaris	220-221
Kit plaques de friction	172
Kit réparation crevaison	151
Klaxon	208
Knobby Gear	142
Land Hawk	142
Lumières chimiques	280
Lunettes Mx/Enduro/VTT	281
Malette VTT	281
Masselottes de variateur Polaris	239
Masses variateur J.Costa	242
Mini compresseur de voyage	151
Mini coupe-chaînes	236
Minipelle multi-usage	280
Mousse de protection guidon	261
Mousse pour guidon	261
Moyeux complets	236
Mud Gear	144
Mud Lite AT / XL	144
Mud Lite XTR	142
Nettoyeur gicleurs	181
Optiques de phare homologuées	207
Palier Complet	248-251
Paquetage hermétique	280
Parabrisés	282
Pastilles de réglage	169
Pelles à neige	282-283
Phares halogènes	210
Pickup	204
Pignons	234
Pilotes/Tulipes homologuées	207
Plaquettes de frein	224-229
Plateau pour charges lourdes VTT	281

Poignée d'accélérateur/gachette	263
Poignées	263
Poignées d'embrayage/de frein	266
Power Gear	141
Power Gear Enduro	141
Prise de courant	210
Protections aluminium ATV	273
Protections aluminium pour quad de sport	269-270
Protections aluminium VTT	275-278
Protections PEHD pour quad de sport	270
Protèges mains	260
Quad Cross MX Pro	140
Quad Cross XC	140
Raccord rapide essence	181
Racer	141
Radiateur chauffage VTU	210
Radiateurs	189
Recharges CO2	151
Régulateur de courant	202-203
Régulateur de tension universel	204
Régulateur de vitesse et tr/min	210
Relais de démarreur	206
Réseaux élastiques	280
Rétroviseurs	209
Rivets de chaîne	235
Rivets en plastique	272
Robinet essence	180
Rotules barre stabilisatrice	217
Rotules de direction	214-215
Rotules des trapèzes	216-217
Rouleaux chaîne	236
Sangle de remorquage	280
Scie Pliable	280
Segments	159-164
Séparateurs aluminium	154-155
Séparateurs en nylon	156
Séparateurs universels	156
Séparateurs VTT	275-278
Soufflet universel+	255
Soufflets palier	254-257
Soupape d'admission/d'échappement	166-167
Soupape d'admission	180
Speed Gear	141
Support cadran	257
Support pelle à neige	282
Support phares/clignotants/feux stop	208
Support pour guidon	212
Tampon en caoutchouc pour amortisseur	222
Témoins lumineux	209
Tendeurs	280
Terracross R/T	143
Thermocontact de ventilateur	190
Tournevis courbé	180
Trail Wolf	142
Tundra Cross	142
Turf Tamer	141
Tuyaux d'échappement GPR	184-185
Ultra Cross	145
Valves à aiguille pour carburateur	179
Valves chambres à air	146
Variateurs J.Costa	243
Vilebrequin complet	171
Vis d'air	180
Vis de rechange séparateurs	155
Vis écrou de fixation de couronne	237
X-100	141
X-500	142
Xtrem Lite	143

RUEDAS Y NEUMÁTICOS



INNOVA MX Enduro / Superenduro

El diseño del taco ofrece una excepcional conducción en off-road, y el diseño de la cubierta absorbe las irregularidades del terreno con total facilidad. La composición de la goma ofrece una gran durabilidad y control en la tierra.

Dimensiones	Referencia	Modelo	Índice velocidad	Peso (kg.)	€
DELANTERAS					
● 80/100-21 (90/90-21)	A080821	3208	51R FIM	3,90	43,74
● 80/100-21 (90/90-21)	A100821	3210	51R FIM	3,90	43,74
TRASERAS					
● 120/90-18	A061218	3206	65M FIM	6,00	52,49
● 140/80-18	A061418	3206	70M FIM	6,00	61,24

● Homologado ITV



IA-3208

IA-3210

IA-3206

INNOVA MX Super X'Gear

Dimensiones	Referencia	Modelo	Índice velocidad	Peso (kg.)	€
DELANTERAS					
80/100-21 (90/90-21)	A070821	3207	51R FIM	3,90	43,74
TRASERAS					
110/100-18	A051118	3205	64M	5,00	58,97
100/90-19	A051019	3205	57M	4,90	64,58
110/90-19	A051119	3205	62M	5,05	64,08
120/90-19	A051219	3205	66M	5,00	66,76



IA-3207

IA-3205

INNOVA MX Top Gear

Dimensiones	Referencia	Modelo	Índice velocidad	Peso (kg.)	€
DELANTERAS					
80/100-21	A300821	3015	51M	3,55	36,56
TRASERAS					
100/100-18	A301018	3014	60M	5,45	47,82
110/100-18	A301118	3014	64M	5,65	52,46
120/100-18	A301218	3014	68M	5,65	54,07
100/90-19	A301019	3014	57M	5,35	46,31
110/90-19	A301119	3014	62M	6,00	50,93



IA-3015

IA-3014

INNOVA Pit Cross

Dimensiones	Referencia	Modelo	Índice Velocidad	Peso (kg.)	€
60/100-10 (2.50-10)	A326010	IA-3203	33J	1,55	18,44
70/100-10 (2.75-10)	A327010	IA-3203	38J	1,55	23,92
60/100-12 (2.50-12)	A326012	IA-3203	4PR	1,85	24,89
80/100-12 (3.00-12)	A328012	IA-3203	50M	2,30	29,40
60/100-14 (2.50-14)	A326014	IA-3202	30M	1,70	25,68
90/100-16 (3.25-16)	A329016	IA-3203	51M	2,30	46,60
70/100-19 (2.75-19)	A327019	IA-3203	42M	2,30	42,12



IA-3202

IA-3203

Precios validos hasta el 31/04/2018

● Homologado ITV

Los neumáticos que no tengan el punto ● no pueden utilizarse para asfalto

RUEDAS Y NEUMÁTICOS

XPEED Protector de llanta

Protege la cámara de los radios. El protector tiene un ancho de 22 mm. Se suministra en paquetes de 1 unidad o 10 unidades.

Referencia	Descripción	€
DMC06358A	1 Protector para llanta de 14"	3,62
DMC06358	10 Protectores para llanta de 14"	14,46
DMC063581A	1 Protector para llanta de 15"	3,62
DMC063581	10 Protectores para llanta de 15"	14,46
DMC063582A	1 Protector para llanta de 16"	3,62
DMC063582	10 Protectores para llanta de 16"	14,46
DMC063583A	1 Protector para llanta de 17"	3,62
DMC063583	10 Protectores para llanta de 17"	14,46
DMC063584A	1 Protector para llanta de 18"	3,62
DMC063584	10 Protectores para llanta de 18"	14,46
DMC063585A	1 Protector para llanta de 19"	3,62
DMC063585	10 Protectores para llanta de 19"	14,46
DMC063587A	1 Protector para llanta de 21"	3,62
DMC063587	10 Protectores para llanta de 21"	14,46



WAYCOM Cámaras aire reforzadas 4 mm

Referencia	Descripción	€
CM9026	2,50/2,75-10 70/100-10	10,75
CM9029	3,25/3,50-14 90/100-14	12,42
CM9030	3,25/3,50-16 90/100-16	13,25
CM9031	2,25/2,50-17 70/100-17	13,25
CM9034	4,25/4,50-18 140/80-18	17,42
CM9035	2,75/3,00-19 70/100-19	14,58
CM9041	4,00/4,10-19 100/90-19	16,58
CM9037	4,25/4,50-19 110/100-19	17,42
CM9038	2,75/3,00-21 80/100-21	15,75
CM9042	3,00/3,25/21 90/90-21	16,25



XPEED Agarre cubierta

Referencia	Descripción	€
DMC06300B	Ancho 1,60"	6,60
DMC06301B	Ancho 1,85"	6,60
DMC06302B	Ancho 2,15"	7,10
DMC06312B	Ancho 2,50"	7,10

Palanca neumáticos

Referencia	Descripción	€
D130020	Largo 40cm	11,06
D1300161	Largo 22cm	6,35
D130023	Largo 38cm	12,58
DMX12100	Largo 26cm	10,28



Talonador de neumáticos

Referencia	€
DUP12051	4,84

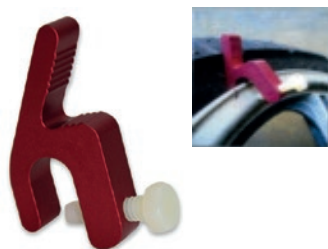

Centrador de cámara

Referencia	€
DUP12037	7,65

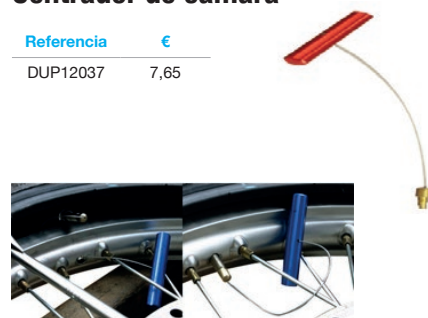

Monta válvulas

Referencia	€
DUP12058	9,48



Destalonador de neumáticos

Referencia	€
DMX12041	19,10



Llave para radios

Referencia	€
D130022	7,28



Reparador válvula llanta

Referencia	Descripción	€
DUP12064	Tipo A	4,20
DUP12046	Tipo B	6,12

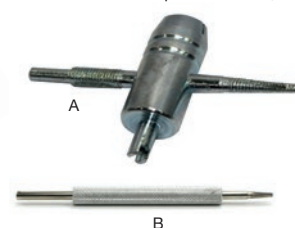



Radios llanta

Juego completo de radios, o radio por separado (tuercas incluidas). Fabricado en acero inoxidable.



			KIT COMPLETO		1 RADIO "LARGO"		1 RADIO "CORTO"	
HONDA	Año	Llanta	Referencia	€	Referencia	€	Referencia	€
CR 125	95-16	21"	DMX06032	63,80	DMX060321	2,00		
CR 125	89-16	18"	DMX06045	66,30	DMX060451	2,00	DMX060452	2,00
CR 125	89-16	19"	DMX06031	63,80	DMX060311	2,00	DMX060312	2,00
CR 250 R	95-16	21"	DMX06032	63,80	DMX060321	2,00		
CR 250 R	89-16	18"	DMX06045	66,30	DMX060451	2,00	DMX060452	2,00
CR 250 R	89-16	19"	DMX06031	63,80	DMX060311	2,00	DMX060312	2,00
CRF 250 R	95-16	21"	DMX06032	63,80	DMX060321	2,00		
CRF 250 R	89-16	18"	DMX06045	66,30	DMX060451	2,00	DMX060452	2,00
CRF 250 R	89-16	19"	DMX06031	63,80	DMX060311	2,00	DMX060312	2,00
XR 400	89-11	21"	DMX06046	63,80	DMX060461	2,00		
CRF 450 R	95-16	21"	DMX06032	63,80	DMX060321	2,00		
CRF 450 R	89-16	19"	DMX06031	63,80	DMX060311	2,00	DMX060312	2,00
CRF 450 X	95-16	21"	DMX06032	63,80	DMX060321	2,00		
CRF 450 X	89-16	18"	DMX06045	66,30	DMX060451	2,00	DMX060452	2,00
XR 600	89-11	21"	DMX06046	63,80	DMX060461	2,00		
XR 600	89-09	18"	DMX06030	66,30	DMX060301	2,00	DMX060302	2,00
XR 650 R	89-11	21"	DMX06046	63,80	DMX060461	2,00		
XR 650 R	89-09	18"	DMX06030	66,30	DMX060301	2,00	DMX060302	2,00
			KIT COMPLETO		1 RADIO "LARGO"		1 RADIO "CORTO"	
KAWASAKI	Año	Llanta	Referencia	€	Referencia	€	Referencia	€
KX 125	99-08	21"	DMX06034	66,30	DMX060341	2,00		
KX 125	99-13	19"	DMX06033	65,70	DMX060331	2,00	DMX060332	2,00
KX 250	99-08	21"	DMX06034	66,30	DMX060341	2,00		
KX 250	99-13	19"	DMX06033	65,70	DMX060331	2,00	DMX060332	2,00
KX 250 F	04-05	21"	DMX06034	66,30	DMX060341	2,00		
KX 250 F	99-13	19"	DMX06033	65,70	DMX060331	2,00	DMX060332	2,00
KLX 450 X	06-13	21"	DMX06035	66,30	DMX060351	2,00		
KX 450 F	06-13	21"	DMX06035	66,30	DMX060351	2,00		
KX 450 F	99-13	19"	DMX06033	65,70	DMX060331	2,00	DMX060332	2,00
			KIT COMPLETO		1 RADIO "LARGO"		1 RADIO "CORTO"	
KTM	Año	Llanta	Referencia	€	Referencia	€	Referencia	€
EXC todas	98-16	21"	DMX06037	69,90	DMX060371	2,00		
SX todas	98-16	21"	DMX06037	69,90	DMX060371	2,00		
XC todas	98-16	21"	DMX06037	69,90	DMX060371	2,00		
SX todas	98-15	19"	DMX06036	65,70	DMX060361	2,00		
125 EXC	89-04	18"	DMX06051	63,80	DMX060511	2,00		
125 SX	92-15	18"	DMX06051	63,80	DMX060511	2,00		
150 XC	10-14	18"	DMX06051	63,80	DMX060511	2,00		
200 EXC	98-06	18"	DMX06051	63,80	DMX060511	2,00		
200 SX	03-04	18"	DMX06051	63,80	DMX060511	2,00		
200 XC	06-09	18"	DMX06051	63,80	DMX060511	2,00		
200 XC-W	06-11	18"	DMX06051	63,80	DMX060511	2,00		
250 EXC	89-04	18"	DMX06051	63,80	DMX060511	2,00		
250 EXC 4t Racing	03-05	18"	DMX06051	63,80	DMX060511	2,00		
250 SX	92-16	18"	DMX06051	63,80	DMX060511	2,00		
250 SX-F	05-15	18"	DMX06051	63,80	DMX060511	2,00		
250 XC	06-16	18"	DMX06051	63,80	DMX060511	2,00		
250 XC-F	07-16	18"	DMX06051	63,80	DMX060511	2,00		
250 XCF-W	07-16	18"	DMX06051	63,80	DMX060511	2,00		
250 XC-W	06-16	18"	DMX06051	63,80	DMX060511	2,00		
300 EXC	90-05	18"	DMX06051	63,80	DMX060511	2,00		
300 XC	06-16	18"	DMX06051	63,80	DMX060511	2,00		
300 XC-W	06-16	18"	DMX06051	63,80	DMX060511	2,00		
350 SX-F	2011	18"	DMX06051	63,80	DMX060511	2,00		
360 EXC	96-97	18"	DMX06051	63,80	DMX060511	2,00		
360 SX	96-97	18"	DMX06051	63,80	DMX060511	2,00		
380 EXC	98-02	18"	DMX06051	63,80	DMX060511	2,00		
400 EXC 4t Racing	00-07	18"	DMX06051	63,80	DMX060511	2,00		
400 LC4 EXC	94-98	18"	DMX06051	63,80	DMX060511	2,00		
400 LC4 SX	1998	18"	DMX06051	63,80	DMX060511	2,00		

RUEDAS Y NEUMÁTICOS

MOTOR

ADMISIÓN / ESCAPE
REFRIGERACIÓN

ELÉCTRICO

SUSPENSIÓN / DIRECCIÓN

FRENOS

TRANSMISIÓN

CONTROLES Y MANDOS

CHASIS

ACCESORIOS

		KIT COMPLETO			1 RADIO "LARGO"		1 RADIO "CORTO"	
SUZUKI	Año	Llanta	Referencia	€	Referencia	€	Referencia	€
RM 125	86-09	19"	DMX06038	65,70	DMX060381	2,00		
RM 250	86-09	21"	DMX06039	63,80	DMX060391	2,00		
RM 250	86-09	19"	DMX06038	65,70	DMX060381	2,00		
RMZ 250	04-06	21"	DMX06034	66,30	DMX060341	2,00		
RMZ 250	04-06	19"	DMX06033	65,70	DMX060331	2,00	DMX060332	2,00
RMZ 250	07-16	21"	DMX06041	66,30	DMX060411	2,00		
RMZ 250	07-13	19"	DMX06040	69,90	DMX060401	2,00	DMX060402	2,00
DR-Z 400	00-09	18"	DMX06054	64,91	DMX060541	2,00		
RMZ450	05-13	21"	DMX06041	66,30	DMX060411	2,00		
RMZ450	07-14	19"	DMX06040	69,90	DMX060401	2,00	DMX060402	2,00

		KIT COMPLETO			1 RADIO "LARGO"		1 RADIO "CORTO"	
YAMAHA	Año	Llanta	Referencia	€	Referencia	€	Referencia	€
WR todas	02-14	21"	DMX06044	66,30	DMX060441	2,00		
WR todas	99-16	18"	DMX06042	63,80	DMX060421	2,00	DMX060422	2,00
YZ todas	02-14	21"	DMX06044	66,30	DMX060441	2,00		
YZ todas	99-16	18"	DMX06042	63,80	DMX060421	2,00	DMX060422	2,00
YZ todas	99-16	19"	DMX06043	66,30	DMX060431	2,00	DMX060432	2,00
YZF todas	02-14	21"	DMX06044	66,30	DMX060441	2,00		
YZF todas	99-16	18"	DMX06042	63,80	DMX060421	2,00	DMX060422	2,00
YZF todas	99-16	19"	DMX06043	66,30	DMX060431	2,00	DMX060432	2,00



Kit de fundas para radios

Cada funda tiene una hendidura no visible por lo que no hay necesidad de desmontar las llantas para instalar. Solo hay que cortar a medida y poner, las fundas tienen un largo de 21 cm. Para dejarlo puesto definitivamente, el usuario puede sellar la unión con una pistola de aire caliente. Fabricado en polietileno (LDPE) de baja densidad.



Referencia	Descripción
DMX06181BU	76 fundas radios azul
DMX06181GN	76 fundas radios verde
DMX06181RD	76 fundas radios roja
DMX06181YL	76 fundas radios amarilla
DMX06181OR	76 fundas radios naranja
DMX06181WI	76 fundas radios blanca

€
13,60



Llave para radios

Se adapta a diferentes medidas:
5,2 / 5,4 / 5,6 / 5,8 / 6,0 / 6,2 / 6,4 / 6,8 / 7,0mm

Referencia	€
DMC127112	38,97





Cojinetes ruedas delanteras y traseras



RUEDAS Y NEUMÁTICOS

MOTOR

ADMISIÓN / ESCAPE REFRIGERACIÓN

ELECTRICO

SUSPENSIÓN / DIRECCIÓN

FRENOS

TRANSMISIÓN

CONTROLES Y MANDOS

CHASIS

ACCESORIOS

APRILIA	Año	Delanteros	€	Traseros	€
RXV 450	06-08			DMX06238	20,40
SXV 450	06-08			DMX06238	20,40
RXV 550	06-08			DMX06238	20,40
SXV 550	06-08			DMX06238	20,40

BETA	Año	Delanteros	€	Traseros	€
250 EVO 2T	2014	DMX06223	18,79		
350 RR 4T	11-14	DMX06223	18,79		
400 RR 4T	05-14	DMX06223	18,79		
450 RR 4T	05-14	DMX06223	18,79		
500 RR 4T	13-14	DMX06223	18,79		
520 RR 4T	10-11	DMX06223	18,79		
525 RR 4T	05-09	DMX06223	18,79		

GAS GAS	Año	Delanteros	€	Traseros	€
EC 50 ROOKIE	04-05	DMX06220	20,40	DMX06220	20,40
SM 50 ROOKIE	04-05	DMX06220	20,40	DMX06220	20,40
EC 125	2003			DMX06262	31,06
EC 125	04-09	DMX06258	18,66	DMX06262	31,06
MC 125	2003			DMX06262	31,06
MC 125	04-09	DMX06258	18,66	DMX06262	31,06
SM 125	03-09			DMX06262	31,06
PAMPERA 125	02-05	DMX06220	20,40	DMX06220	20,40
EC 200	2003			DMX06262	31,06
EC 200	04-09	DMX06258	18,66	DMX06262	31,06
EC 250	2003			DMX06262	31,06
EC 250	04-09	DMX06258	18,66	DMX06262	31,06
MC 250	2003			DMX06262	31,06
MC 250	04-09	DMX06258	18,66	DMX06262	31,06
SM 250	03-05			DMX06262	31,06
PAMPERA 250	02-05	DMX06220	20,40	DMX06220	20,40
PAMPERA 280	02-05	DMX06220	20,40	DMX06220	20,40
EC 300	2003	DMX06258	18,66	DMX06262	31,06
EC 300	04-09	DMX06258	18,66	DMX06262	31,06
EC 450 FSE	03-06	DMX06258	18,66	DMX06262	31,06
EC 450 FSR	07-09	DMX06258	18,66	DMX06262	31,06
MC 450 FSR	2007	DMX06258	18,66	DMX06262	31,06
PAMPERA 450	2007	DMX06258	18,66	DMX06262	31,06
SM 450 FSE	04-05	DMX06258	18,66	DMX06262	31,06
SM 450 FSR	07-09	DMX06258	18,66	DMX06262	31,06

HONDA	Año	Delanteros	€	Traseros	€
CRF 50 F	04-12	DMX06202	19,16	DMX06203	23,37
CRF 50 F	13-15			DMX06203	23,37
XR 50 R	00-03	DMX06202	19,16	DMX06203	23,37
CRF 70 F	04-12	DMX06202	19,16	DMX06204	17,55
XR 70 R	97-03	DMX06202	19,16	DMX06204	17,55
CR 80 R	83-85	DMX06202	19,16	DMX06204	17,55
CR 80 R	86-91	DMX06202	19,16		
CR 80 R	92-02	DMX06202	19,16	DMX06205	17,48
CR 80 RB	90-91	DMX06202	19,16		
CR 80 RB	92-95	DMX06202	19,16	DMX06205	17,48
CRF 80 F	04-13	DMX06202	19,16	DMX06204	17,55
XR 80	85-03	DMX06202	19,16	DMX06204	17,55
CR 85 R	03-07	DMX06202	19,16	DMX06205	17,48
CRF 100 F	04-13	DMX06202	19,16	DMX06204	17,55
XR 100 R	85-03	DMX06202	19,16	DMX06204	17,55
CRF 110 F	13-15	DMX06202	19,16		
CR 125 R	83-84			DMX06206	21,64
CR 125 R	85-86	DMX06206	21,64	DMX06206	21,64
CR 125 R	87-89	DMX06206	21,64		
CR 125 R	90-94	DMX06206	21,64	DMX06207	21,40

CR 125 R	95-99	DMX06209	24,31	DMX06207	21,40
CR 125 R	00-07	DMX06209	24,31	DMX06208	20,52
CRF 125 F	14-15	DMX06202	19,16	DMX06604	17,55
CRF 150 F	02-15	DMX06210	20,15	DMX06211	23,37
CRF 150 R	07-15	DMX06248	20,77	DMX06249	25,85
CRF 150 RB	07-15	DMX06248	20,77	DMX06249	25,85
XR 200 R	81-82			DMX06212	23,87
XL 200 R	83-84			DMX06212	23,87
CRF 230 F	03-15	DMX06210	20,15	DMX06211	23,37
CR 250 R	85-89	DMX06206	21,64		
CR 250 R	90-94	DMX06206	21,64	DMX06207	21,40
CR 250 R	95-99	DMX06209	24,31	DMX06207	21,40
CR 250 R	00-07	DMX06209	24,31	DMX06208	20,52
CRF 250 R	04-15	DMX06209	24,31	DMX06208	20,52
CRF 250 X	04-15	DMX06264	30,13	DMX06208	20,52
XR 250 R	92-95	DMX06241	20,52		
XR 250 R	96-04	DMX06241	20,52	DMX06242	23,87
XR 250 R	84-85			DMX06212	23,87
XR 350 R	83-84			DMX06212	23,87
XR 400 R	96-04	DMX06243	21,51	DMX06242	23,87
CRF 450 R	02-15	DMX06209	24,31	DMX06208	20,52
CRF 450 X	05-15	DMX06264	30,13	DMX06208	20,52
CR 500 R	85-89	DMX06206	21,64		
CR 500 R	90-94	DMX06206	21,64	DMX06207	21,40
CR 500 R	95-01	DMX06209	24,31	DMX06207	21,40
XR 600 R	93-00	DMX06243	21,51		
XR 650 L	93-15	DMX06243	21,51	DMX06212	23,87
XR 650 R	00-07	DMX06243	21,51		

HUSABERG	Año	Delanteros	€	Traseros	€
FE 250	13-14	DMX06223	18,79	DMX06247	17,48
TE 250	11-14	DMX06223	18,79	DMX06247	17,48
TE 300	11-14	DMX06223	18,79	DMX06247	17,48
FE 350	2013	DMX06223	18,79	DMX06247	17,48
FE 390	10-11	DMX06223	18,79	DMX06247	17,48
FC 450	04-05	DMX06223	18,79	DMX06247	17,48
FE 450	04-14	DMX06223	18,79	DMX06247	17,48
FS 450	2004	DMX06223	18,79	DMX06247	17,48
FX 450	10-11	DMX06223	18,79	DMX06247	17,48
FS-C 450	05-06	DMX06223	18,79	DMX06247	17,48
FS-E 450	05-08	DMX06223	18,79	DMX06247	17,48
FE 501	13-14	DMX06223	18,79	DMX06247	17,48
FE 550	07-08	DMX06223	18,79	DMX06247	17,48
FS-E 550	2007	DMX06223	18,79	DMX06247	17,48
FE 570	09-11	DMX06223	18,79	DMX06247	17,48
FS 570	09-11	DMX06223	18,79	DMX06247	17,48
FC 650	04-05	DMX06223	18,79	DMX06247	17,48
FE 650	04-08	DMX06223	18,79	DMX06247	17,48
FS 650	04-08	DMX06223	18,79	DMX06247	17,48
FS-C 650	05-06	DMX06223	18,79	DMX06247	17,48
FS-E 650	05-07	DMX06223	18,79	DMX06247	17,48

HUSQVARNA	Año	Delanteros	€	Traseros	€
CR 125	01-13	DMX06259	18,91		
WR 125	02-13	DMX06259	18,91		
CR 250	01-04	DMX06259	18,91		
TC 250	03-11	DMX06259	18,91		
TE 250	03-11	DMX06259	18,91		
TXC 250	08-11	DMX06259	18,91		
WR 250	03-13	DMX06259	18,91		
WR 300	08-13	DMX06259	18,91		
TE 310	09-11	DMX06259	18,91		
SMR 450	04-09	DMX06259	18,91		
TC 450	03-10	DMX06259	18,91		

RUEDAS Y NEUMÁTICOS

PSYCHIC
MOTORCYCLES

Cojinetes ruedas delanteras y traseras



TE 450	03-10	DMX06259	18,91		
TXC 450	08-10	DMX06259	18,91		
SM 510	2010	DMX06259	18,91		
SMR 510	04-09	DMX06259	18,91		
TC 510	05-09	DMX06259	18,91		
TE 510	04-10	DMX06259	18,91		
TXC 510	08-10	DMX06259	18,91		
SM 610	06-08	DMX06259	18,91		
SMR 610	04-09	DMX06259	18,91		
TC 610	2001	DMX06259	18,91		
TE 610	06-08	DMX06259	18,91		
SMS 610	10-11	DMX06259	18,91		
TE 630	10-11	DMX06259	18,91		

KAWASAKI	Año	Delanteros	€	Traseros	€
KX 60	83-03			DMX06213	25,36
KX 65	00-15	DMX06213	25,36	DMX06213	25,36
KV 75	71-80	DMX06203	23,37	DMX06203	23,37
KD 80	88-90	DMX06203	23,37	DMX06203	23,37
KDX 80	84-88			DMX06203	23,37
KX 80	83-85			DMX06203	23,37
KX 80	98-00	DMX06203	23,37	DMX06214	19,80
KX 85	01-15	DMX06213	25,36	DMX06214	19,80
KX 100	98-15	DMX06213	25,36	DMX06214	19,80
KLX 110	02-12	DMX06239	18,17	DMX06240	26,72
KLX 125	03-09			DMX06213	25,36
KLX 125 L	03-06			DMX06213	25,36
KX 125	86-92	DMX06216	22,01	DMX06217	21,30
KX 125	93-96	DMX06218	18,79	DMX06217	21,30
KX 125	97-02	DMX06218	18,79	DMX06219	18,29
KX 125	03-05	DMX06218	18,79	DMX06238	20,40
KLX 200	08-14			DMX06214	19,80
KDX 200	89-06	DMX06265	10,73	DMX06217	21,30
KDX 220	97-05	DMX06265	10,73	DMX06217	21,30
KDX 220	05-07			DMX06217	21,30
KDX 250	91-94	DMX06265	10,73	DMX06217	21,30
KLX 250	94-96	DMX06265	10,73	DMX06217	21,30
KLX 250	06-07	DMX06265	10,73	DMX06217	21,30
KX 250	86-92	DMX06216	22,01	DMX06217	21,30
KX 250	1993	DMX06218	18,79	DMX06217	21,30
KX 250	94-95	DMX06218	18,79	DMX06217	21,30
KX 250	1996	DMX06218	18,79	DMX06217	21,30
KX 250	1997	DMX06218	18,79	DMX06219	18,29
KX 250	1998	DMX06218	18,79	DMX06219	18,29
KX 250	99-02	DMX06218	18,79	DMX06219	18,29
KX 250	03-07	DMX06218	18,79	DMX06238	20,40
KX 250 F	04-16	DMX06218	18,79	DMX06238	20,40
KLX 300 R	97-07	DMX06265	10,73	DMX06217	21,30
KLX 400	03-05	DMX06218	18,79	DMX06236	30,44
KX 450 F	06-15	DMX06218	18,79	DMX06238	20,40
KLX 450 R	08-10	DMX06218	18,79	DMX06238	20,40
KX 500	86-93	DMX06216	22,01	DMX06217	21,30
KX 500	94-96	DMX06218	18,79	DMX06217	21,30
KX 500	97-04	DMX06218	18,79	DMX06219	18,29
KLX 650 R	93-98	DMX06265	10,73		

KTM	Año	Delanteros	€	Traseros	€
60 SX	98-00	DMX06220	20,40		
65 SX	98-14	DMX06220	20,40		
65 XC	98-14	DMX06220	20,40		

85 SX	03-07	DMX06253	29,45	DMX06247	17,48
85 SX	08-11	DMX06221	21,33	DMX06247	17,48
85 XC	03-11	DMX06221	21,33	DMX06247	17,48
105 SX	06-11	DMX06221	21,33	DMX06247	17,48
125 DXC	88-91	DMX06221	21,33	DMX06247	17,48
125 EGS	88-91	DMX06221	21,33	DMX06247	17,48
125 Enduro	88-90	DMX06221	21,33	DMX06247	17,48
125 EXS	93-02			DMX06247	17,48
125 EXC	03-09	DMX06223	18,79	DMX06247	17,48
125 MX	88-91	DMX06221	21,33	DMX06247	17,48
125 MX	93-99	DMX06221	21,33	DMX06222	17,55
125 MX	00-02	DMX06209	24,31	DMX06247	17,48
125 MXC	93-99			DMX06247	17,48
125 MXC	00-02	DMX06222	17,55	DMX06247	17,48
125 MXC	03-05	DMX06223	18,79	DMX06247	17,48
125 SX	93-97	DMX06221	21,33	DMX06222	17,55
125 SX	98-99	DMX06253	29,45	DMX06222	17,55
125 SX	00-02	DMX06209	24,31	DMX06247	17,48
125 SX	03-14	DMX06223	18,79	DMX06247	17,48
144 SX	07-08	DMX06223	18,79	DMX06247	17,48
150 SX	09-14	DMX06223	18,79	DMX06247	17,48
150 XC	10-14	DMX06223	18,79	DMX06247	17,48
200 EGS	98-99			DMX06247	17,48
200 EXC	98-99			DMX06247	17,48
200 EXC	00-02	DMX06222	17,55	DMX06247	17,48
200 EXC	03-05	DMX06223	18,79	DMX06247	17,48
200 MX	98-99	DMX06221	21,33	DMX06247	17,48
200 MX	00-02	DMX06209	24,31	DMX06247	17,48
200 MXC	98-99			DMX06247	17,48
200 MXC	00-02	DMX06222	17,55	DMX06247	17,48
200 MXC	03-05	DMX06223	18,79	DMX06247	17,48
200 SX	98-99	DMX06253	29,45	DMX06247	17,48
200 SX	00-02	DMX06209	24,31	DMX06247	17,48
200 SX	03-05	DMX06223	18,79	DMX06247	17,48
200 XC	06-11	DMX06223	18,79	DMX06247	17,48
200 XCW	06-11	DMX06223	18,79	DMX06247	17,48
240 Enduro	88-89	DMX06220	20,40		
240 MX	88-89	DMX06220	20,40		
250 DXC	88-90	DMX06220	20,40		
250 DXC	1991	DMX06221	21,33	DMX06247	17,48
250 EGS	88-90	DMX06220	20,40		
250 EGS	1991	DMX06221	21,33	DMX06247	17,48
250 EGS	93-99			DMX06247	17,48
250 EXC	88-90	DMX06220	20,40		
250 EXC	1991	DMX06221	21,33	DMX06247	17,48
250 EXC	93-99			DMX06247	17,48
250 EXC	00-02	DMX06222	17,55	DMX06247	17,48
250 EXC	03-09	DMX06223	18,79	DMX06247	17,48
250 MX	93-99	DMX06221	21,33	DMX06247	17,48
250 MX	00-02	DMX06209	24,31	DMX06247	17,48
250 MXC	88-90	DMX06220	20,40		
250 MXC	1991	DMX06221	21,33	DMX06247	17,48
250 MXC	93-99			DMX06247	17,48
250 MXC	00-02	DMX06222	17,55	DMX06247	17,48
250 MXC	03-09	DMX06223	18,79	DMX06247	17,48
250 SX	93-97	DMX06221	21,33	DMX06247	17,48
250 SX	98-99	DMX06253	29,45	DMX06247	17,48
250 SX	00-02	DMX06209	24,31	DMX06247	17,48
250 SX	03-14	DMX06223	18,79	DMX06247	17,48



Cojinetes ruedas delanteras y traseras

Solo para kits KTM

Si añade una "P" al final de estas referencias el kit será con tubo separador

KIT NORMAL		KIT CON SEPARADOR	
DMX06220	20,40€	DMX06220P	36,00€
DMX06221	21,33€	DMX06221P	36,00€
DMX06222	17,55€	DMX06222P	36,00€
DMX06223	18,79€	DMX06223P	36,00€
DMX06247	17,48€	DMX06247P	36,00€



DMX06247P

250 SXF	05-14	DMX06223	18,79	DMX06247	17,48
250 XC	06-14	DMX06223	18,79	DMX06247	17,48
250 XCF	07-09	DMX06223	18,79	DMX06247	17,48
250 XCFW	06-14	DMX06223	18,79	DMX06247	17,48
250 XCW	06-14	DMX06223	18,79	DMX06247	17,48
300 DXC	1990	DMX06220	20,40		
300 EGS	1990	DMX06220	20,40		
300 EGS	1991	DMX06221	21,33	DMX06247	17,48
300 EGS	93-99			DMX06247	17,48
300 EXC	1990	DMX06220	20,40		
300 EXC	1991	DMX06221	21,33	DMX06247	17,48
300 EXC	93-99			DMX06247	17,48
300 EXC	00-02	DMX06222	17,55	DMX06247	17,48
300 EXC	03-05	DMX06223	18,79	DMX06247	17,48
300 MX	93-99	DMX06221	21,33	DMX06247	17,48
300 MX	00-02	DMX06209	24,31	DMX06247	17,48
300 MXC	1990	DMX06220	20,40		
300 MXC	1991	DMX06221	21,33	DMX06247	17,48
300 MXC	93-99			DMX06247	17,48
300 MXC	00-02	DMX06222	17,55	DMX06247	17,48
300 MXC	03-05	DMX06223	18,79	DMX06247	17,48
300 SX	93-97	DMX06221	21,33	DMX06247	17,48
300 SX	98-99	DMX06253	29,45	DMX06247	17,48
300 SX	00-02	DMX06209	24,31	DMX06247	17,48
300 SX	03-05	DMX06223	18,79	DMX06247	17,48
300 XC	06-14	DMX06223	18,79	DMX06247	17,48
300 XCW	06-14	DMX06223	18,79	DMX06247	17,48
350 DXC	90-91	DMX06221	21,33	DMX06247	17,48
350 EGS	90-91	DMX06221	21,33	DMX06247	17,48
350 EXC	90-91	DMX06221	21,33	DMX06247	17,48
350 MX	90-91	DMX06221	21,33	DMX06247	17,48
350 SX-F	11-14	DMX06223	18,79	DMX06247	17,48
360 EGS	96-97			DMX06247	17,48
360 EXC	96-97			DMX06247	17,48
360 MXC	96-97			DMX06247	17,48
360 SX	96-97	DMX06221	21,33	DMX06247	17,48
380 EGS	98-99			DMX06247	17,48
380 EXC	98-99			DMX06247	17,48
380 EXC	00-02	DMX06222	17,55	DMX06247	17,48
380 MX	98-99	DMX06221	21,33	DMX06247	17,48
380 MX	00-02	DMX06209	24,31	DMX06247	17,48
380 MXC	98-99			DMX06247	17,48
380 MXC	00-02	DMX06222	17,55	DMX06247	17,48
380 SX	98-99	DMX06253	29,45	DMX06247	17,48
380 SX	00-02	DMX06209	24,31	DMX06247	17,48
400 EXC	00-02	DMX06222	17,55	DMX06247	17,48
400 EXC Racing	04-05	DMX06222	17,55	DMX06247	17,48
400 EXC-G	2006	DMX06223	18,79	DMX06247	17,48
400 LC4	94-99			DMX06247	17,48
400 RXC	94-99			DMX06247	17,48
400 Competition	94-99			DMX06247	17,48
400 MX	97-99	DMX06221	21,33	DMX06247	17,48
400 MX	00-02	DMX06209	24,31	DMX06247	17,48
400 MXC	00-02	DMX06222	17,55	DMX06247	17,48
400 SC	96-99			DMX06247	17,48
400 SX	97-99	DMX06221	21,33	DMX06247	17,48
400 SX	00-02	DMX06209	24,31	DMX06247	17,48
400 SXC	96-99			DMX06247	17,48
400 SXC	00-02	DMX06222	17,55	DMX06247	17,48

400 XCW	07-10	DMX06223	18,79	DMX06247	17,48
440 EXC	1995			DMX06247	17,48
440 MXC	1994	DMX06221	21,33	DMX06247	17,48
440 SX	1994	DMX06221	21,33	DMX06247	17,48
450 EXC	03-11	DMX06223	18,79	DMX06247	17,48
450 EXC-G	03-07	DMX06223	18,79	DMX06247	17,48
450 EXC Racing (4t)	04-05	DMX06223	18,79	DMX06247	17,48
450 EXC-R	2008	DMX06223	18,79	DMX06247	17,48
450 MXC	03-07	DMX06223	18,79	DMX06247	17,48
450 MXC-G	03-07	DMX06223	18,79	DMX06247	17,48
450 SX	03-13	DMX06223	18,79	DMX06247	17,48
450 SX-F	03-11	DMX06223	18,79	DMX06247	17,48
450 XC	04-07	DMX06223	18,79		
450 XCW	07-14	DMX06223	18,79	DMX06247	17,48
500 DXC	1990	DMX06220	20,40		
500 DXC	1992	DMX06221	21,33	DMX06247	17,48
500 EGS	1990	DMX06220	20,40		
500 EXC	1990	DMX06220	20,40		
500 EXC	1992	DMX06221	21,33	DMX06247	17,48
500 EXC	1995			DMX06247	17,48
520 EXC	2000	DMX06222	17,55		
520 EXC	01-02	DMX06222	17,55	DMX06247	17,48
500 LC4	1991	DMX06221	21,33		
500 MX	1990	DMX06220	20,40		
500 MX	1992	DMX06221	21,33	DMX06247	17,48
500 MX	1993	DMX06221	21,33	DMX06247	17,48
500 MXC	1993	DMX06221	21,33	DMX06247	17,48
505 SXF	2008	DMX06223	18,79	DMX06247	17,48
505 XCF	08-09	DMX06223	18,79	DMX06247	17,48
520 MX	01-02	DMX06209	24,31	DMX06247	17,48
520 MXC	2000	DMX06222	17,55		
520 MXC	01-02	DMX06222	17,55	DMX06247	17,48
520 SX	01-02	DMX06209	24,31	DMX06247	17,48
525 EXC	03-05	DMX06223	18,79	DMX06247	17,48
525 EXC-G	03-05	DMX06223	18,79	DMX06247	17,48
525 MXC	03-05	DMX06223	18,79	DMX06247	17,48
525 SX	03-14	DMX06223	18,79	DMX06247	17,48
525 SMR	03-14	DMX06223	18,79	DMX06247	17,48
525 XC	06-07	DMX06223	18,79	DMX06247	17,48
525 XCW	2007	DMX06223	18,79		
530 EXC	10-11	DMX06223	18,79	DMX06247	17,48
530 EXC-R	08-09	DMX06223	18,79	DMX06247	17,48
530 XCW	08-09	DMX06223	18,79	DMX06247	17,48
540 DXC	1990	DMX06223	18,79		
540 DXC	1991	DMX06221	21,33	DMX06247	17,48
540 EGS	1990	DMX06223	18,79		
540 EGS	1991	DMX06221	21,33	DMX06247	17,48
540 EXC	1990	DMX06223	18,79		
540 EXC	1991	DMX06221	21,33	DMX06247	17,48
540 MX	1990	DMX06223	18,79		
540 MX	1991	DMX06221	21,33	DMX06247	17,48
540 SXC	1999			DMX06247	17,48
550 DXC	1992	DMX06221	21,33	DMX06247	17,48
550 EXC	1992	DMX06221	21,33	DMX06247	17,48
550 MX	1992	DMX06221	21,33	DMX06247	17,48
550 MX	93-96	DMX06221	21,33	DMX06247	17,48
550 MXC	93-96	DMX06221	21,33	DMX06247	17,48
600 DXC	1990	DMX06220	20,40		
600 EGS	1990	DMX06220	20,40		

RUEDAS Y NEUMÁTICOS

MOTOR

ADMISIÓN / ESCAPE
REFRIGERACIÓN

ELECTRICO

SUSPENSIÓN / DIRECCIÓN

FRENOS

TRANSMISIÓN

CONTROLES Y MANDOS

CHASIS

ACCESORIOS



Cojinetes ruedas delanteras y traseras



600 EXC	1990	DMX06220	20,40		
600 LC4	1991	DMX06221	21,33		
600 MX	1990	DMX06220	20,40		
620 EGS	1997	DMX06221	21,33		
620 SC	96-97			DMX06247	17,48
620 SX	96-99	DMX06221	21,33	DMX06247	17,48
625 EXC	03-05	DMX06222	17,55	DMX06247	17,48
625 MXC	03-05	DMX06222	17,55	DMX06247	17,48
625 SX	03-05	DMX06222	17,55	DMX06247	17,48
640 Adventure	98-00	DMX06221	21,33		
640 Adventure	2003	DMX06222	17,55		
640 LC4-E	00-01	DMX06222	17,55		
690 Duke	2008	DMX06223	18,79		
690 Rally Replica	2008	DMX06223	18,79		
690 R Enduro	09-12	DMX06223	18,79	DMX06247	17,48
950 Adventure	04-06	DMX06223	18,79		
950 Super Duke	06-08	DMX06223	18,79		
950 Super Enduro	2007	DMX06223	18,79	DMX06247	17,48
990 Adventure	07-12	DMX06223	18,79	DMX06247	17,48
990 Super Moto	10-11	DMX06223	18,79	DMX06247	17,48

SUZUKI

	Año	Delanteros	€	Traseros	€
RM 60	2003			DMX06213	25,36
RM 65	03-05	DMX06213	25,36	DMX06213	25,36
RM 80	86-89			DMX06205	17,48
RM 80	90-01	DMX06203	23,37	DMX06224	19,19
RM 85	02-12	DMX06203	23,37	DMX06224	19,19
DR 100	83-90	DMX06203	23,37		
RM 100	2003			DMX06214	19,80
DR-Z 110	03-05	DMX06239	18,17	DMX06240	26,72
DR 125	82-96	DMX06203	23,37		
DR-Z 125	03-05			DMX06213	25,36
DR-Z 125 L	03-06	DMX06203	23,37	DMX06213	25,36
RM 125	87-94	DMX06220	20,40		
RM 125	1995	DMX06220	20,40	DMX06225	20,73
RM 125	96-99	DMX06218	18,79	DMX06225	20,73
RM 125	2000	DMX06218	18,79	DMX06226	25,11
RM 125	01-08	DMX06227	21,30	DMX06226	25,11
SP 125	82-88	DMX06203	23,37		
DR 200	86-08	DMX06203	23,37		
SP 200	86-88	DMX06203	23,37		
DR 250	82-85	DMX06203	23,37	DMX06228	30,32
DR 250	90-93			DMX06228	30,32
DR-Z 250	01-07	DMX06229	21,02	DMX06228	30,32
RM 250	87-95	DMX06220	20,40		
RM 250	96-99	DMX06218	18,79	DMX06225	18,41
RM 250	2000	DMX06218	18,79	DMX06226	25,11
RM 250	01-08	DMX06227	21,30	DMX06226	25,11
RMX 250	93-98	DAT06677	22,26		
RM-Z 250	04-06	DMX06218	18,79	DMX06238	20,40
RM-Z 250	07-13	DMX06251	20,40	DMX06208	20,52
DR 350	90-99	DAT06677	22,26	DMX06228	30,32
DR-Z 400 E	00-07	DMX06218	18,79		
DR-Z 400 S	00-13	DMX06218	18,79		
DR-Z 400 SM	05-08	DMX06218	18,79		
RM-Z 450	05-11	DMX06251	20,40	DMX06208	20,52
RMX 450	2010	DMX06251	20,40	DMX06208	20,52
DR 650 SE	96-05	DAT06677	22,26	DMX06208	20,52

YAMAHA	Año	Delanteros	€	Traseros	€
DT 50	88-90			DMX06231	17,30
TTR 50	06-15	DMX06230	19,03	DMX06230	19,03
YZ 85	93-01	DMX06230	19,03	DMX06224	19,19
YZ 85	02-15	DMX06230	19,03	DMX06224	19,19
TT 125	2000	DMX06231	17,30		
TTR 125 L Disco	00-15	DMX06232	19,78	DMX06231	17,30
TTR 125 Mordaza	00-09	DMX06231	17,30	DMX06231	17,30
YZ 125	86-97			DMX06233	23,13
YZ 125	1998	DMX06234	19,16	DMX06233	23,13
YZ 125	99-17	DMX06234	19,16	DMX06235	21,20
RT 180	95-98	DMX06214	19,80		
IT 200	1986	DMX06214	19,80		
WR 200	1992			DMX06233	23,13
TT 225	86-87	DMX06214	19,80		
TT 225	99-00	DMX06214	19,80		
TTR 225 R	01-05	DMX06214	19,80		
XT 225	92-07	DMX06214	19,80		
TTR 230	05-07	DMX06214	19,80		
WR 250	1991	DMX06214	19,80	DMX06233	23,13
WR 250	92-97			DMX06233	23,13
WR 250 F	01-17	DMX06234	19,16	DMX06235	21,20
YZ 250	83-87	DMX06214	19,80		
YZ 250	88-91	DMX06214	19,80	DMX06233	23,13
YZ 250	92-97			DMX06233	23,13
YZ 250	1998	DMX06234	19,16	DMX06233	23,13
YZ 250	99-17	DMX06234	19,16	DMX06235	21,20
YZ 250 F	01-08	DMX06234	19,16	DMX06235	21,20
YZ 250 F	09-13	DMX06234	19,16	DMX06252	24,40
YZ 250 F	14-17	DMX06251			
TT 350	86-87	DMX06214	19,80		
XT 350	85-00	DMX06214	19,80		
WR 400 F	1998	DMX06234	19,16	DMX06233	23,13
WR 400 F	99-00	DMX06234	19,16	DMX06235	21,20
YZ 400 F	1998	DMX06234	19,16	DMX06235	21,20
YZ 400 F	1999	DMX06234	19,16	DMX06233	23,13
WR 426 F	2000			DMX06235	21,20
WR 426 F	02-01	DMX06234	19,16	DMX06235	21,20
YZ 426 F	00-02	DMX06234	19,16	DMX06235	21,20
WR 450 F	03-17	DMX06234	19,16	DMX06235	21,20
YZ 450 F	03-08	DMX06234	19,16	DMX06235	21,20
YZ 450 F	09-13	DMX06234	19,16	DMX06252	24,40
YZ 450 F	14-17	DMX06251	20,40		
YZ 490	84-90	DMX06214	19,80		
WR 500	92-93	DMX06214	19,80	DMX06233	23,13
TT 600	85-86	DMX06214	19,80		
XT 600	84-95	DMX06214	19,80		

MOTOR

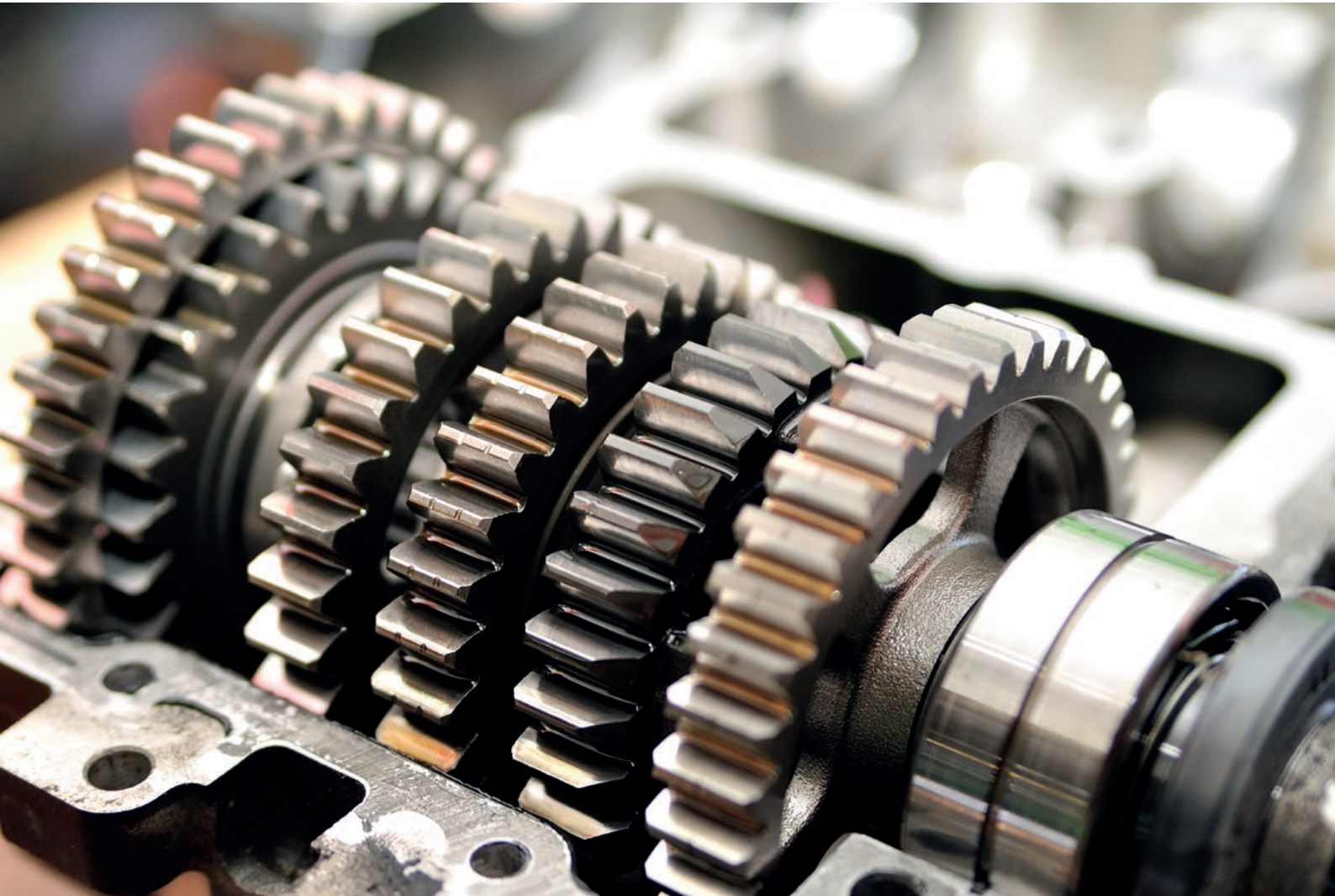



Kit de pistón racing Incluye Pistón, Segmentos, Bulón, Circlips

HONDA		Cilindro	Kit Pistón	€	Juntas Cilindro COMETIC	€
• CRF 150R 04-09	Diámetro: 66 mm Carrera: 43.7 mm					
66 mm. Calibre STD. (149 cc)	13.0:1	Original (Válvula cóncava)	M2043C	185,40		
• CRF 250R 04-08 SOLO COMPETICIÓN	Diámetro: 78 mm Carrera: 52.2 mm					
78 mm. Calibre STD. (249 cc)	14.5:1	Original			MC7185	44,52
• CRF 250R 2009	Diámetro: 78 mm Carrera: 52.2 mm					
78 mm. Calibre STD. (249 cc)	13.5:1	Original	M2060C	185,40	MC7185	44,52
• CRF 250R 10-13	Diámetro: 76,8 mm Carrera: 53,8 mm					
76,8 mm. Calibre STD. (249 cc)	13.5:1	Original	MX2070C	185,40	MC3288	44,52
• XR 400 R 96-09	Diámetro: 85 mm Carrera: 70 mm					
86 mm Sobremedida (407 cc)	12.5:1	Rectificar	M2006	185,40		
• CRF 450R 02-08	Diámetro: 96 mm Carrera: 62 mm					
96 mm. Calibre STD. (449 cc)	13.5:1	Original	M2010	185,40		
• CRF 450R 09-13	Diámetro: 96 mm Carrera: 62 mm					
96 mm. Calibre STD. (449 cc)	13.0:1	Original	MX2058	185,40	MC3270	58,31
96 mm. Calibre STD. (449 cc)	13.5:1	Original	MX2059	185,40	MC3270	58,31
• CRF 450R 09-13 SOLO COMPETICIÓN	Diámetro: 96 mm Carrera: 62 mm					
96 mm. Calibre STD. (449 cc)	14.0:1	Original	M2063	185,40	MC3270	58,31
KAWASAKI		Cilindro	Kit Pistón	€	Juntas Cilindro COMETIC	€
• KX 250F 05-09	Diámetro: 77 mm Carrera: 53.6 mm					
77 mm. Calibre STD. (250 cc)	13.5:1	Original	M3023C	185,40	MC3054 (05-08) MC3267HB (09)	58,48 52,79
79 mm Sobremedida (263 cc)	12.5:1	Rectificar y nicasilar	M3001C	185,40		
• KX 250F 2010	Diámetro: 77 mm Carrera: 53.6 mm					
77 mm. Calibre STD. (250 cc)	14.2:1	Original	MX3051C	185,40	MC3267HB	52,79
• KX 450F 04-08	Diámetro: 96 mm Carrera: 62.1 mm					
96 mm. Calibre STD. (449 cc)	13.5:1	Original	M3010	185,40		
• KX 450F 09-10	Diámetro: 96 mm Carrera: 62.1 mm					
96 mm. Calibre STD. (449 cc)	13.5:1	Original	M3036	185,40		
KTM		Cilindro	Kit Pistón	€	Juntas Cilindro COMETIC	€
• 450 SX-F / XC-F / RSF 07-10	Diámetro: 97 mm Carrera: 60.8 mm					
97 mm. Calibre STD. (450 cc)	13.5:1	Original	M9007	185,40		-
• 450 EXC 03-07 / 450 XC 08-12	Diámetro: 89 mm Carrera: 72 mm					
89 mm. Calibre STD. (450 cc)	13.0:1	Original	M9009	185,40		-
• 450 EXC 03-12 / 450 XC 2008 SOLO COMPETICIÓN	Diámetro: 89 mm Carrera: 72 mm					
89 mm. Calibre STD. (450 cc)	13.5:1	Original	M9010	185,40		-
• 520 EXC 00-02 / 525 EXC 03-07	Diámetro: 95 mm Carrera: 72 mm					
95 mm. Calibre STD. (525 cc)	13.0:1	Original	M9012	185,40		-
SUZUKI		Cilindro	Kit Pistón	€	Juntas Cilindro COMETIC	€
• RM-Z 250 04-06	Diámetro: 77 mm Carrera: 53.6 mm					
77 mm. Calibre STD. (250 cc)	13.5:1	Original	M3023C	185,40	MC3054	58,48
79 mm Sobremedida (263 cc)	12.5:1	Rectificar y nicasilar	M3001C	185,40		
• RM-Z 250 07-09	Diámetro: 77 mm Carrera: 53.6 mm					
77 mm. Calibre STD. (249 cc)	13.5:1	Original	M3017C	185,40		
77 mm. Calibre STD. (249 cc)	14.2:1	Original	M3016C	185,40		
• RM-Z 450 08-09	Diámetro: 96 mm Carrera: 62.1 mm					
96 mm. Calibre STD. (449 cc)	13.0:1	Original	MX3020	185,40		
96 mm. Calibre STD. (449 cc)	13.5:1	Original	M3021	185,40		
96 mm. Calibre STD. (449 cc)	13.5:1	Original	MX3021	185,40		
YAMAHA		Cilindro	Kit Pistón	€	Juntas Cilindro COMETIC	€
• YZ 250F 05-13	Diámetro: 77 mm Carrera: 53.6 mm					
77 mm. Calibre STD. (250 cc)	13.5:1	Original	M1034C	185,40	MC3057	58,36
77 mm. Calibre STD. (250 cc)	13.5:1	Original	MX1034C	185,40	MC3057	58,36
77 mm. Calibre STD. (250 cc)	14.0:1	Original	M1035C	185,40	MC3057	58,36
79 mm. Sobremedida. (263 cc)	13.5:1	Rectificar y nicasilar	M1036C	185,40	MC3057	58,36
• WR 250 09-10	Diámetro: 77 mm Carrera: 53.6 mm					
81 mm. Sobremedida. (276 cc)	12.5:1	Cilindro especial o camisa	MX1067C	185,40		
• YZ 450F 03-09	Diámetro: 95 mm Carrera: 63.4 mm					
95 mm. Calibre STD. (449 cc)	13.5:1	Original	M1011	185,40	MC7947-EST (03-05) MC7908-EST (06-09)	67,95 67,95
• YZ 450F 03-09 SOLO COMPETICIÓN	Diámetro: 95 mm Carrera: 63.4 mm					
95 mm. Calibre STD. (449 cc)	13.75:1	Original	M1043	185,40	MC7947-EST (03-05) MC7908-EST (06-09)	67,95 67,95
• YZ 450F 10-13	Diámetro: 97 mm Carrera: 60.8 mm					
97 mm. Calibre STD. (449 cc)	13.0:1	Original	MX1068	185,40	MC3395	58,15



Modelo X-PROJECT
Más ligero, faldas de pistón recubiertas para limitar la fricción, reduce el balanceo del pistón y ranuras anti-detonación, ranura acumuladora, lubricadores de doble salida, forjado, cúpulas sostenidas.



Modelo CP
Ranuras anti-detonación, ranura acumuladora, lubricadores de doble salida, forjado, cúpulas sostenidas.



Kit de pistón y juntas

La medida del pistón corresponde a la medida real. El cilindro debe tener un diámetro de entre un 0,04mm y 0,07mm más grueso, dependiendo de cada fabricante de motocicletas.

		PISTÓN, SEGMENTOS, BULÓN, CIRCLIPS		RODAMIENTO PISTÓN		SEGMENTOS		JUNTAS CILINDRO		JUNTAS MOTOR		
BETA	Año	Medidas (mm)	Referencia	€	Referencia	€	Referencia	€	Referencia	€	Referencia	€
RK6 Enduro	97-02	39,46 39,47 39,48	NX70000 NX70000-B NX70000-C	60,18	N09B041	4,06	NX70000R	5,83				
RR 250 Enduro 2t	13-14	66,34 66,35 66,36	NX70051 NX70051-B NX70051-C	93,66	N09B0371	8,65	NX70050R	7,96				
		PISTÓN, SEGMENTOS, BULÓN, CIRCLIPS		RODAMIENTO PISTÓN		SEGMENTOS		JUNTAS CILINDRO		JUNTAS MOTOR		
GAS GAS	Año	Medidas (mm)	Referencia	€	Referencia	€	Referencia	€	Referencia	€	Referencia	€
EC 125 (pistón curvado) Comp. 8,6:1 STD	00-11	53,94 53,95 53,96	NX10003 NX10003-B NX10003-C	68,49	N09B0381	8,65	NX20000R	9,53	NX12000T	33,15	NX12000F	63,38
EC 125 Racing	13-15								NX12000T	33,15	NX12000F	63,38
MC 125 (pistón plano) Comp. 8,8:1 STD	02-10	53,94 53,95 53,96 54,44 54,94 55,44	NX10000 NX10000-B NX10000-C NX10000-2 NX10000-4 NX10000-6	76,70	N09B0381	8,65	NX10000R NX10000R NX10000R NX10000-2R NX10000-4R NX10000-6R	10,98	NX12000T	33,15	NX12000F	63,38
EC 200	97-13								NX12000T	33,15	NX12000F	63,38
EC 250	97-14	66,34 66,35 66,36	NX70051 NX70051-B NX70051-C	93,66	N0950501	9,70	NX70050R	7,96	NX12001T	38,13		
EC 250 F 4t Cilindro Nikasil Comp. 13,5:1	10-15	76,94 76,95 76,96	NX40033 NX40033-B NX40033-C	174,78			NX20030R	15,58	NX40032T	43,29	NX40036F	68,79
EC 300	97-13								NX12001T	38,13	NX12001F	67,50
EC 450 F Cilindro Nikasil	13-15	94,95 94,96 94,97	NX40045 NX40045-B NX40045-C	179,75			NA40009R	25,39	NX40046T	44,37		
		PISTÓN, SEGMENTOS, BULÓN, CIRCLIPS		RODAMIENTO PISTÓN		SEGMENTOS		JUNTAS CILINDRO		JUNTAS MOTOR		
HONDA	Año	Medidas (mm)	Referencia	€	Referencia	€	Referencia	€	Referencia	€	Referencia	€
CRF 70 F XR 70 R	04-12 97-03	46,97 47,47 47,97	NX10070 NX10070-2 NX10070-4	61,46			NX10070R		NX10070T	15,83	NX10070F	33,37
CR 80 R** Cilindro Nikasil	86-02	46,94 46,95 46,96 47,44 47,94 48,44	NX10080 NX10080-B NX10080-C NX10080-2 NX10080-4 NX10080-6	74,32	N09B0121	7,29	NX10080R NX10080R NX10080R NX10080-2R NX10080-4R NX10080-6R	7,35	NX10080T (86-91) NX10081T (92-02)	13,65 18,54	NX10080F (86-91) NX10081F (92-02)	36,91 39,78
CRF 80 F XR 80	04-12 93-03								NX10083T	28,46	NX10083F	47,82
CR 85 R Compr. 8,4:1 Cilindro Nikasil	03-07	47,44 47,45 47,46 47,94 48,44	NX10080-2 NX10080-2B NX10080-2C NX10080-4 NX10080-6	74,32	N09B0121	7,29	NX10080-2R NX10080-2R NX10080-2R NX10080-4R NX10080-6R	7,35	NX10081T	18,54	NX10081F	39,78
CRF 100 F XR 100 R	04-13 92,03								NX10100T	23,98	NX10100F	50,48
CR 125 R Compr. 8,8:1 Cilindro Nikasil	92-03	53,94 53,95 53,96 54,44 54,94 55,44	NX10000 NX10000-B NX10000-C NX10000-2 NX10000-4 NX10000-6	76,70	N09B0011	7,29	NX10000R NX10000R NX10000R NX10000-2R NX10000-4R NX10000-6R	10,98	NX10000T (92-99) NX10001T (00-02) NX10003T (03)	24,01 23,95 32,82	NX10000F (92-98) NX10001F (00-02) NX10002F (03)	51,64 54,23 58,65
CR 125 R Compr. 8,6:1 Cilindro Nikasil	04-07	53,94 53,95 53,96	NX10003 NX10003-B NX10003-C	68,49	N09B0011	7,29	NX20000R	9,53	NX10003T (04) NX10004T (05-07)	32,82 30,58	NX10003F (04) NX10004F (05-07)	57,55 59,32
CRE F125 X CRM F 125 X	08-10 08-10								NX40093T	37,38	NX40093F	92,03
CRF 150 F	03-05								NX10150T	35,53	NX10150F	61,50
CRF 150 F	06-15								NX10151T	29,84	NX10151F	52,80
CRF 150 R	07-14								NX10152T	66,53	NX10152F	106,28
XR 200 R	81-02								NX10200T (92-02)	25,22	NX10200F (92-02)	37,21

** Pistón o aros Namura no son intercambiables por aros o pistones originales. / En Azul pistones Hyperdryve.

RUEDAS Y NEUMÁTICOS
 MOTOR
 ADMISIÓN / ESCAPE
 REFRIGERACIÓN
 ELÉCTRICO
 SUSPENSIÓN / DIRECCIÓN
 FRENS
 TRANSMISIÓN
 CONTROLES Y MANDOS
 CHASIS
 ACCESORIOS

Kit de pistón y juntas



Kit juntas motor

		PISTÓN, SEGMENTOS, BULÓN, CIRCLIPS			RODAMIENTO PISTÓN		SEGMENTOS		JUNTAS CILINDRO		JUNTAS MOTOR	
CRF 230 F	03-16										NX10230F	56,61
CRF 230 L	08-09								NX10230T	32,49	NX10231F	33,32
CRF 230 M	08-09										NX10231F (CRF230L,M)	
CR 250 R Cilindro Nikasil Compr. 8.5:1	86-96	66,34 66,35 66,36 66,84 67,34 67,84	NX10026 NX10026-B NX10026-C NX10026-2 NX10026-4 NX10026-6	90,57	N095051	9,17	NX10026R NX10026R NX10026R NX10026-2R NX10026-4R NX10026-6R	15,58	NX10026T (86-91) NX10025T (92-01)	18,07 25,97	NX10026F (89-91) NX10025F (92-01)	54,23 56,61
CR 250 R Cilindro Nikasil Compr. 8.5:1	97-01	66,34 66,35 66,36 66,84 67,34 67,84	NX10025 NX10025-B NX10025-C NX10025-2 NX10025-4 NX10025-6	91,78	N095051	9,17	NX10025R NX10025R NX10025R NX10025-2R NX10025-4R NX10025-6R	14,56	NX10025T	25,97	NX10025F	56,61
CR 250 R Compr. 8.5:1 Cilindro Nikasil	02-04	66,34 66,35 66,36	NX10027 NX10027-B NX10027-C	91,53	N095051	9,17	NX10025R	14,56	NX10027T	33,51	NX10027F	58,71
CR 250 R Compr. 8.5:1 Cilindro Nikasil	05-07	66,34 66,35 66,36	NX10028 NX10028-B NX10028-C	80,37	N095051	9,17	NX10028R	11,88	NX10028T	34,37	NX10028F	65,70
CRF 250 R** CRF 250 X** Compr. 13.2:1	04-09 05-16	77,96 77,97 77,98	NX10035 NX10035-B NX10035-C	157,73			NX10035R	19,20	NX10030T (04-13)	58,99	NX10030F (04-13)	115,65
CRF 250 R Compr. 13.2:1	10-13	76,80 76,81 76,82	NX10039 NX10039-B NX10039-C	157,51			NX10039R	19,01	NX10031T	67,28	NX10031F	103,41
CRF 250 R Compr. 13.5:1	14-17	76,80 76,81 76,82	NX10041 NX10041-B NX10041-C	166,88			NX10039R	19,01	NX10031T (14-16)	67,28	NX10031F (14-16)	103,41
CRF 250 L	13-16								NX10040T	84,79	NX10040F	119,05
XR 250 R	96-04								NX10250T	44,37	NX-10251F	79,98
XR 400 R	96-04	84,97 85,47 85,97 86,47	NA10003 NA10003-2 NA10003-4 NA10003-6	102,64			NA10003R NA10003-2R NA10003-4R NA10003-6R	22,93	NA10003T	60,04	NX10006F	67,85
CRF 450 R Compr. 12.0:1	02-08	95,97 95,98 95,99	NX10045 NX10045-B NX10045-C	174,25			NX10045R	21,69	NX10045T (02-06) NX10046T (07-08)	60,62 61,58	NX10045F (02-06) NX10047F (07-08)	100,84 118,94
CRF 450 R** Compr. 12.0:1	09-12	95,97 95,98 95,99	NX10046 NX10046-B NX10046-C	171,96			NX10045R	21,69	NX10048T	72,17	NX10048F	114,60
CRF 450 R	13-16	95,97	NX10048 NX10048-B NX10048-C	180,80			NX10045R	21,69	NX10048T	72,17	NX10048F	114,60
CRF 450 X Compr. 12.0:1	05-16	95,97 95,98 95,99	NX10045 NX10045-B NX10045-C	174,25			NX10045R	21,69	NX10046T	61,58	NX10046F	109,08
CR 500	84-01								NX10050T (89-01)	31,39	NX10050F (89-01)	63,13

		PISTÓN, SEGMENTOS, BULÓN, CIRCLIPS			RODAMIENTO PISTÓN		SEGMENTOS		JUNTAS CILINDRO		JUNTAS MOTOR	
HUSABERG												
Año	Medidas (mm)	Referencia	€	Referencia	€	Referencia	€	Referencia	€	Referencia	€	
TE 125	12-14	53,94 53,95 53,96	NX70029 NX70029-B NX70029-C	82,83	N09B0131	8,65	NX70029R	17,84	NX70030T	33,29	NX70030F	61,83
TE 250 (motor KTM 2t)	11-14	66,34 66,35 66,36	NX70051 NX70051-B NX70051-C	93,66	N09B0371	8,65	NX70050R	7,96	NX70053T	23,43	NX70053F	53,32
FE 250 Compr. 13,2:1	2013	75,96 75,97 75,98	NX70060 NX70060-B NX70060-C	170,47			NX70060R	19,01	NX70060T	62,49		
TE 300	11-14	71,94 71,95 71,96	NX70034 NX70034-B NX70034-C	121,31			NX70034R	22,65	NX70036T	23,90	NX70036F	57,41
FC 350 FE 350	2014 13-14	87,96 87,97 87,98	NX70062 NX70062-B NX70062-C	190,83			NX70062R	19,75	NX70073T	104,63		
FE 390	10-11								NX70068T	66,67		
FE 450 FX 450	09-12 10-12	94,94 94,95 94,96	NX70068 NX70068-B NX70068-C	179,03			NX70041R	19,98	NX70068T	66,67		
FE 570 FS 570	2010 2010								NX70068T	66,67		



Kit de pistón y juntas



Kit juntas cilindro

HUSQVARNA	Año	Medidas (mm)	PISTÓN, SEGMENTOS, BULÓN, CIRCLIPS		RODAMIENTO PISTÓN		SEGMENTOS		JUNTAS CILINDRO		JUNTAS MOTOR	
			Referencia	€	Referencia	€	Referencia	€	Referencia	€	Referencia	€
TC 85	2014	46,95 46,96 46,97	NX70004 NX70004-B NX70004-C	62,16	N09B0121	7,29	NX10080R	7,35	NX70007T	22,21	NX70007F	49,29
CR 125 WR 125 WRE 125 SM 125 / S	97-14 97-14 98-10 98-14	53,94 53,95 53,96	NX10003 NX10003-B NX10003-C	68,49	N09B0011	7,29	NX20000R	9,53	NX90000T	32,24		
TE 125 SM S4	10-13								NX40093T	37,38	NX40093F	92,03
TC 125 TE 125 "2 segmentos"	14-16 14-16	53,94 53,95 53,96	NX70029 NX70029-B NX70029-C	82,83	N09B0131	8,65	NX70029R	17,84	NX70030T	33,29	NX70030F	61,83
CR 250 R	98-13	66,34 66,35 66,36	NX10025 NX10025-B NX10025-C	91,78			NX10025R	14,56				
TC 250 TE 250 TXC 250 SMR 250	03-04 03-04 03-04 03-04								NX90004T	48,24		
TC 250 (motor KTM) TE 250 (motor KTM)	14-16 14-16	66,34 66,35 66,36	NX70051 NX70051-B NX70051-C	93,66	N09B0131	8,65	NX70050R	7,96	NX70053T	23,43	NX70053F	53,32
TC 250 TE 250 TXC 250 SMR 250	05-11 05-12 05-12 05-09								NX90005T (05-09) NX90011T (10-12)	104,43 90,09	NX90011F (10-12)	178,15
TC 250 TE 250 TXC 250	12-14 13-14 13-14								NX90010T	90,09	NX90010F	182,18
FC 250	2014								NX70065T	117,28	NX70065F	213,65
CR 250 WR 250	99-12 99-13	66,34 66,35 66,36	NX10025 NX10025-B NX10025-C	91,78			NX10025R	14,56	NX90003T	39,76		
TE 300 (motor KTM) WR 300 (motor KTM)	14-16 08-13	71,94 71,95 71,96	NX70034 NX70034-B NX70034-C	121,31	N09B0131	8,65	NX70034R	22,65	NX70036T TE 300 NX90003T WR 300	23,90 39,76	NX70036F TE300	57,41
FE 350 FC 350	14-16 14-16	87,96 87,97 87,98	NX70062 NX70062-B NX70062-C	190,83			NX70062R	19,75	NX70073T FC350 (14-15)	104,63	NX70073F FC350 (14-15)	185,77
TC 449	11-14								NX90015T	100,62	NX90015F	195,88
TXC 449	11-12								NX90015T	100,62	NX90015F	195,88
TE 449	11-14								NX90015T	100,62	NX90015F	195,88
TCX 511	11-13								NX90015T	100,62	NX90015F	195,88
TE 511	11-14								NX90015T	100,62	NX90015F	195,88
TXC 511	11-13								NX90015T	100,62	NX90015F	195,88
SMR 511	11-12								NX90015T	100,62	NX90015F	195,88
TC 450 TE 450 SMR 450 TC 510 TE 510 R	03-04 03-04 03-04 2004 2004								NX90008T	53,38		
FC 450	14-16								NX70072T	91,92	NX70072F	185,74
SMR 450	2015								NX70072T	91,92	NX70072F	185,74
FE450	14-16								NX70066T	94,02	NX70066F	172,26
FE501	14-16								NX70066T	94,02	NX70066F	172,26
TE 450 TXC 450 SMR 450 TC 510 SMR 510	05-09 05-10 05-09 05-10 05-09								NX90009T	104,43		
TC 610 TE 610 SM 610 S WXE 610	93-06 90-06 2001 90-96								NX90012T	50,42		

** Pistón o aros Namura no son intercambiables por aros o pistones originales. / En Azul pistones Hyperdryve.



Kit de pistón y juntas

KAWASAKI	Año	Medidas (mm)	PISTÓN, SEGMENTOS, BULÓN, CIRCLIPS		RODAMIENTO PISTÓN		SEGMENTOS		JUNTAS CILINDRO		JUNTAS MOTOR	
			Referencia	€	Referencia	€	Referencia	€	Referencia	€	Referencia	€
KDX 50	03-06	40,96 41,46 41,96	NX30050 NX30050-2 NX30050-4	41,03	N09B0001	7,29	NX30050R NX30050-2R NX30050-4R	9,53	NX20055T	8,68	NX20055F	23,15
KX 60 Cilindro Nikasil	83-03	42,95 42,96 42,97	NX20060 NX20060-B NX20060-C	59,04	N09B0001	7,29	NX20060R	10,03	NX20060T (85-03)	11,91	NX20060F (85-03)	23,40
KX 65 Compr. 8.4:1 Cilindro Nikasil	00-14	44,45 44,46 44,47 44,96 45,46 45,95	NX20065 NX20065-B NX20065-C NX20065-2 NX20065-4 NX20065-6	59,04	N09B0431	7,82	NX20060-6R NX20060-6R NX20060-6R NX20065-2R NX20065-4R NX20065-6R	10,03	NX20065T	21,27	NX20065F (00-05) NX20066F (06-14)	39,04 39,20
KX 80 Cilindro Nikasil	88-00	47,95 47,96 47,97 48,45 48,95	NX20080 NX20080-B NX20080-C NX20080-2 NX20080-4	81,80	N09B0061	8,12	NX20080R NX20080R NX20080R NX20080-2R NX20080-4R	14,20	NX20082T (88-90) NX20080T (91-97) NX20081T (98-00)	12,43 16,47 19,84	NX20082F (88-90) NX20080F (91-97) NX20081F (98-00)	28,68 27,90 36,55
KX 85 Compr. 9.2:1 Cilindro Nikasil	01-13	48,45 48,46 48,47	NX20085 NX20085-B NX20085-C	83,01	N09B0061	8,12	NX20080-2R	14,20	NX20085T	17,76	NX20085F	51,17
KX 85	14-17	48,45 48,46 48,47	NX20013 NX20013-B NX20013-C	76,36	N09B0061	8,12	NX20013R	7,54	NX20013T (14-16)	32,30	NX20013F (14-16)	73,93
KX 100	95-13	52,44 52,45 52,46	NX20010 NX20010-B NX20010-C	80,45	N09B0061	8,12	NX20010R	13,54	NX20010T	25,14	NX20010F	50,84
KLX 110	02-16								NX20011T	28,76	NX20011F	48,71
KLX 125 L	03-06								NX20007T	27,32	NX20007F	54,79
KX 125	90-91	53,95			N095021	8,16			NX20001T	29,84	NX20001F	50,01
KX 125	92-94	53,95							NX20003T	31,07	NX20003F	56,31
KX 125	95-97	53,95			N09B0131	8,65			NX20002T	30,45	NX20002F	54,23
KX 125	98-00	53,94 53,95 53,96	NX20000 NX20000-B NX20000-C	75,01	N09B0131	8,65	NX20000R	9,53	NX20000T	32,88	NX20000F	54,23
KX 125	01-02	53,94 53,95 53,96	NX20001 NX20001-B NX20001-C	77,94	N09B0131	8,65	NX20000R	9,53	NX20000T	32,88		
KX 125	2003	53,95 53,96 53,97	NX20002 NX20002-B NX20002-C	79,43	N09B0131	8,65	NX20000R	9,53	NX20004T	25,61	NX20004F	50,42
KX 125	04-05	53,97 53,98 53,99	NX20005 NX20005-B NX20005-C	69,24	N09B0131	8,65	NX20000R	9,53	NX20005T	25,61	NX20004F	50,42
KDX 200	89-94				N095021	8,16			NX20008T	30,58	NX20008F	56,11
KDX 200	95-06				N095021	8,16			NX20009T		NX20009F	
KDX 220	97-05								NX20009T	31,72	NX20009F	61,56
KDX 250	91-94								NX20023T	43,29	NX20023F	63,10
KLX 250 R KLX 250 S KLX 250 SF	94-96 06-14 09-10								NX20036T	34,65	NX20036F	69,24
KX 250** Cilindro Nikasil	93-04	66,35 66,36 66,37 66,85 67,35 67,85	NX20025 NX20025-B NX20025-C NX20025-2 NX20025-4 NX20025-6	89,63	N09B0221	9,17	NX20025R NX20025R NX20025R NX20025-2R NX20025-4R NX20025-6R	15,78	NX20026T (92-03) NX20028T (04)	31,99 44,43	NX20026F (93-03) NX20028F (04)	72,72 66,22
KX 250 Cilindro Nikasil	05-08	66,35 66,36 66,37	NX20029 NX20029-B NX20029-C	92,42	N09B0221	9,17	NX20029R	15,58	NX20029T	31,11	NX20029F	56,80
KX 250 F Compr. 12.6:1 Forjado Cilindro Chrome composite	04-05	76,95 76,96 76,97	NX20030 NX20030-B NX20030-C	171,90			NX20030R	15,58	NX20030T	71,42	NX20030F	83,99

** Pistón o aros Namura no son intercambiables por aros o pistones originales. / En Azul pistones Hyperdryve.



Kit de pistón y juntas



			PISTÓN, SEGMENTOS, BULÓN, CIRCLIPS		RODAMIENTO PISTÓN	SEGMENTOS		JUNTAS CILINDRO		JUNTAS MOTOR		
KX 250 F Compr. 13.5:1 Forjado	06-09	76,95 76,96 76,97	NX20031 NX20031-B NX20031-C	171,90		NX20030R	15,58	NX20030T (06-08) NX20017T (09-13)	71,42 68,99	NX20030F (06-08) NX20017F (09-13)	83,99 103,19	
KX 250 F** Compr. 13.8:1 Forjado Cilindro Nikasil	10-16	76,95 76,96 76,97	NX20017 NX20017-B NX20017-C	144,17		NX20017R	19,20	NX20017T (10-14)	68,99	NX20017F (10-13)	103,19	
KLX 300 R	97-07							NX20037T	34,37	NX20037F	68,08	
KLX 400 Compr. 11.3:1 Cilindro Nikasil	03-06	89,96 89,97 89,98 90,46 90,96 91,46	NA30002 NA30002-B NA30002-C NA30002-2 NA30002-4 NA30002-6	135,63		NA30002R NA30002R NA30002R NA30002-2R NA30002-4R NA30002-6R	25,58	NA30002T	48,76	NX30041F	100,59	
KLX 450 R	08-14							NX20045T	71,42	NX20048F	105,54	
KX 450 F Compr. 12.8:1	06-16	95,95 95,96 95,97	NX20045 NX20045-B NX20045-C	173,48		NX20045R	21,69	NX20045T (06-08) NX20018T (09-14)	71,42 72,83	NX20045F (06-08) NX20018F (09-14)	113,74 121,48	
KX 500	89-04				N09B036	6,47		NX20050T	33,49	NX20050F	45,03	
			PISTÓN, SEGMENTOS, BULÓN, CIRCLIPS		RODAMIENTO PISTÓN	SEGMENTOS		JUNTAS CILINDRO		JUNTAS MOTOR		
KTM	Año	Medidas (mm)	Referencia	€	Referencia	€	Referencia	€	Referencia	€	Referencia	€
50 SX pro JR / SR LC 50 Mini / Jr / Sen. Adven. 50 SX Pro JR, SR LC, sen. Adv. 50 SX pro, SR LC, sen. Adv. 50 SX, SX JR, sen. Adv. 50 SX, SX JR, SX mini LC cilindro nikasil	01-02 2002 2003 04-05 06-07 2008	39,46 39,47 39,48	NX70000 NX70000-B NX70000-C	60,18	N09B041	4,06	NX70000R	5,83	NX70000T SX 50 LC (01-08) NX70001T ADV 50 A/C (02-08) NX70010T ADV 50 A/C (97-01)	11,88 9,31 10,17	NX70000F SX 50 LC (01-08) NX70001F ADV 50 A/C (02-08)	20,86 16,60
50 SX	09-16	39,46 39,47 39,48	NX70020 NX70020-B NX70020-C	62,14			NX70000R	5,83	NX70020T	15,94	NX70020F	47,30
60 SX cilindro nikasil	98-00	43,46 43,47 43,48	NX70002 NX70002-B NX70002-C	56,61			NX70002R	5,83	NX70003T	15,94	NX70003F	47,30
65 SX 65 XC cilindro nikasil	98-08 2008	44,96 44,97 44,98	NX70002-6 NX70002-6B NX70002-6C	56,61	N09B0422	7,29	NX70002-6R	5,83	NX70003T	16,58	NX70003F	46,06
65 SX 65 XC	09-16 09-16	44,96 44,97 44,98	NX70005 NX70005-B NX70005-C	62,61	N09B0422	7,29	NX70002-6R	5,83	NX70005T	17,46	NX70005F	55,17
85 SX 85 XC cilindro nikasil	03-16 03-16	46,95 46,96 46,97	NX70004 NX70004-B NX70004-C	62,16	N09B0121	7,29	NX10080R	7,35	NX70004T (03-12) NX70007T (13-14)	23,26 22,21	NX70004F (03-12) NX70007F (13-14)	53,49 49,29
125 EXC 125 SX cilindro nikasil	94-00 94-00	54,19 54,20 54,21	NX70026 NX70026-B NX70026-C	81,48	N09B0131	8,65	NX20000-1R	9,53	NX70025T (91-97) NX70026T (98-00)	21,30 28,02	NX70025F (91-97)	53,43
125 SX** 125 EXC** cilindro nikasil 2 segmentos	01-16 01-16	53,94 53,95 53,96	NX70029 NX70029-B NX70029-C	82,83	N09B0131	8,65	NX70029R	17,84	NX70026T (2001) NX70027T (02-06) NX70030T (07-14)	28,02 28,90 33,29	NX70026F (2001) NX70027F (02-06) NX70030F (07-14)	62,00 55,59 61,83
125 SX GP SERIES** cilindro nikasil 1 segmento	01-14	53,95 53,96 53,97	NX30002 NX30002-B NX30002-C	68,96	N09B0131	8,65	NX20000R	9,53	NX70026T (2001) NX70027T (02-06) NX70030T (07-13)	28,02 28,90 33,29	NX70027F (02-06) NX70030F (07-13)	55,59 61,83
200 EXC 200 MXC	98-14 98-14	63,94 63,95 63,96	NX70021 NX70021-B NX70021-C	101,48	N09B0821	8,65	NX70021R	22,43	NX70022T EXC (98-02) NX70021T EXC (03-14)	31,66 23,54	NX70022F EXC (98-02) NX70021F EXC (03-14)	71,11 48,76
200 SX	98-14	63,94 63,95 63,96	NX70022 NX70022-B NX70022-C	88,36	N09B0821	8,65	NX70022R	11,60	NX70022T EXC (98-02) NX70021T EXC (03-14)	31,66 23,54	NX70022F EXC (98-02) NX70021F EXC (03-14)	71,11 48,76
200XC-W	06-14								NX70021T	23,54	NX70021F	48,78
250 SX & SX M 250 EXC, E-XC E, EGS M cilindro nikasil	90-94	67,44 67,45 67,46	NX70040 NX70040-B NX70040-C	87,64	N09B0371	8,65	NX70040R	15,78	NX70040T	23,98	NX70040F	61,56
250 SX 250 EGS cilindro nikasil	1995 1995	67,44 67,45 67,46			N09B0371	8,65	NX70040R	15,78	NX70040T	23,98	NX70040F	61,56
250 SX, EXC, EGS, MXC cilindro nikasil	96-99	67,44 67,45 67,46	NX70047 NX70047-B NX70047-C	85,93	N09B0371	8,65	NX70040R	15,78	NX70040T	23,98	NX70040F	61,56

** Pistón o aros Namura no son intercambiables por aros o pistones originales. / [En Azul pistones Hyperdryve.](#)

RUEDAS Y NEUMÁTICOS
MOTOR
ADMISIÓN / ESCAPE REFRIGERACIÓN
ELECTRICO
SUSPENSIÓN / DIRECCIÓN
FRENS
TRANSMISIÓN
CONTROLES Y MANDOS
CHASIS
ACCESORIOS

Kit de pistón y juntas



Kit juntas motor

			PISTÓN, SEGMENTOS, BULÓN, CIRCLIPS		RODAMIENTO PISTÓN		SEGMENTOS		JUNTAS CILINDRO		JUNTAS MOTOR		
250 SX & SXS 250 EXC 250 MXC cilindro nikasil	00-02	66,34	NX70050	84,52	N09B0371	8,65	NX70050R	7,96	NX70049T	28,51	NX70040F	61,56	
	00-06	66,35	NX70050-B						NX70050T	23,98	NX70050F	48,24	
	00-05	66,36	NX70050-C						EXC (2004)	25,14	EXC (2004)	59,35	
250 SX & SXS 250 XC, XCW, XCW-E 250 EXC 2t 250 R Freeride cilindro nikasil	03-16	66,34	NX70051	93,66	N09B0371	8,65	NX70050R	7,96	NX70050T	23,98	NX70050F	48,24	
	06-12								SX (03-04)	25,14	SX (03-04)	59,35	
	06-15								NX70051T	23,43	NX70051F	53,32	
	2014								SX (05-06)		SX (05-06)		
									XC, XC-W (2006)		XC, XC-W (06)		
			EXC 2t (06-07)	NX70053F									
			NX70053T	SXS (2007)									
			SXS (07)	SX, XC (07-12)									
			EXC 2t (08-15)	XC-W (07-12)									
				EXC 2t (08-15)									
250 EXC 4 t	01-06								NX70061T	55,15	NX70061F	104,99	
250 SX-F 250 XC-F, XCF-W 250 EXC-F	05-12	75,96	NX70060	170,47			NX70060R	19,01	NX70060T	62,49	NX70060F	109,49	
	07-13	75,97	NX70060-B										
	07-13	75,98	NX70060-C										
250 SX-F 250 XC-F 250 EXC-F six days	13-14								NX70065T	117,28	NX70065F	213,65	
	13-14												
	2014												
300 EXC, SX 300 XC, XC-W	90-03									23,13	NX70033F	55,06	
	90-07												
													NX70034T
									XC, XCW (06-07)	22,85	XC, XCW (06-07)	54,15	
300 EXC 300 XC 300 XC-W	04-16	74,94	NX70034	121,31	N09B0371	8,65	NX70034R	22,65		23,90	NX70034F	57,41	
	08-16	74,95	NX70034-B										
	08-16	74,96	NX70034-C										
350 EXC-F 350 Freeride 350 SX-F 350 XC-F 350 XCF-W	12-16	87,96	NX70062	190,83				NX70062R	19,75	65,59	NX70062F	105,38	
	11-15												
	11-15												
	2012												
	12-16												
360 SX, EXC	96-97									22,52	NX70037F	54,15	
380 SX, EXC	98-02									22,52	NX70037F	54,15	
450 EXC 450 SMS 450 XC-W 450 SMR 450 SX 450 SXS 450 XC	03-07										49,29	NX70038F	103,80
	2004												
	2007												
	05-07												
	03-06												
05-06													
04-07													
450 EXC 450 EXC-R	08-12	94,94	NX70068	179,03					NX70041R	19,98	NX70068T	91,45	
	08-12	94,95	NX70068-B										
	08-12	94,96	NX70068-C										
450 SX-F, SXS-F 450 XC-F	07-12		NX70070	191,74					NX70070R	19,98	NX70070T	82,22	
	08-09												
450 EXC, XC-W 450 SX-F 500 EXC, XC-W 450 SX-F, XC-F 450 SMR	12-13									66,67	NX70063F	91,45	
	2013												
	12-13												
450 SX-F, XC-F 450 SMR	14-16									91,92	NX70072F	185,74	
	2014												
505 XC-F, SX-F, SX	08-09									62,72	NX70080F	89,85	
520 SX, MXC, EXC	00-02									51,00	NX70039F	103,80	
530 EXC 530 SX 530 XC	03-07									51,00	NX70039F	103,80	
530 EXC-R	08-12	94,94	NX70041	181,49					NX70041R	19,98	NX70068T	91,45	
		94,95	NX70041-B										
		94,96	NX70041-C										
530 EXC, XC-W	09-11										NX70063F	91,45	

			PISTÓN, SEGMENTOS, BULÓN, CIRCLIPS		RODAMIENTO PISTÓN		SEGMENTOS		JUNTAS CILINDRO		JUNTAS MOTOR	
RIEJU	Año	Medidas (mm)	Referencia	€	Referencia	€	Referencia	€	Referencia	€	Referencia	€

125 PRO/SM Marathon	2009								NX40093T	37,38	NX40093F	92,03
---------------------	------	--	--	--	--	--	--	--	----------	-------	----------	-------

			PISTÓN, SEGMENTOS, BULÓN, CIRCLIPS		RODAMIENTO PISTÓN		SEGMENTOS		JUNTAS CILINDRO		JUNTAS MOTOR	
SUZUKI	Año	Medidas (mm)	Referencia	€	Referencia	€	Referencia	€	Referencia	€	Referencia	€

JR 50	78-07		NX30050	41,03	N09B0001	7,29	NX30050R	9,53	NX20055T	8,68	NX20055F	23,15
			NX30050-2				NX30050-2R					
			NX30050-4				NX30050-4R					



Kit de pistón y juntas



			PISTÓN, SEGMENTOS, BULÓN, CIRCLIPS		RODAMIENTO PISTÓN		SEGMENTOS		JUNTAS CILINDRO		JUNTAS MOTOR	
RM 60 cilindro electrofusión	2003	42,95 42,96 42,97	NX20060 NX20060-B NX20060-C	59,04	N09B0001	7,29	NX20060R	10,03	NX20060T	11,91	NX20060F	23,40
RM 65 cilindro electrofusión	03-07	44,45 44,46 44,47 44,96 45,46 45,95	NX20065 NX20065-B NX20065-C NX20065-2 NX20065-4 NX20065-6	59,04	N09B0431	7,82	NX20060-6R NX20060-6R NX20060-6R NX20065-2R NX20065-4R NX20065-6R	10,03	NX20065T (03-05)	21,27	NX20065F (03-05)	39,04
RM 80**	91-01	47,43 47,44 47,45 47,93 48,43 48,93	NX30080 NX30080-B NX30080-C NX30080-2 NX30080-4 NX30080-6	77,25	N09B0121	7,29	NX10080-2R NX10080-2R NX10080-2R NX30080-2R NX30080-4R NX30080-6R	7,35 10,49	NX30080T	13,59	NX30080F	31,94
RM 85 cilindro SCEM	02-12	47,94 47,95 47,96	NX30085 NX30085-B NX30085-C	74,82	N09B0121	7,29	NX20080-RA	9,81	NX30085T	17,99	NX30085F	38,96
RM 100	03-04	52,44 52,45 52,46	NX20010 NX20010-B NX20010-C	80,45	N09B0061	8,12	NX20010R	13,54	NX20010T	25,14		
DR-Z 110	03-05								NX20011T	28,76	NX20011F	48,71
DR 125	94-96								NX30010T	18,01	NX30007F	30,75
DR-Z 125 L	03-09								NX20007T	27,32	NX20007F	54,79
RM 125 cilindro SCEM	89-00	53,94 53,95 53,96 54,44 54,94 55,44	NX30000 NX30000-B NX30000-C NX30000-2 NX30000-4 NX30000-6	76,50	N09B0131	8,65	NX20000R NX20000R NX20000R NX10000-2R NX10000-4R NX10000-6R	9,53 10,98	NX30000T (90-00)	22,54	NX30000F (92-97) NX30001F (98-00)	57,22 51,19
RM 125	01-03	53,94 53,95 53,96	NX30004 NX30004-B NX30004-C	74,93	N09B0131	8,65	NX20000R	9,53	NX30000T	22,54	NX30002F	51,19
RM 125** cilindro nikasil	04-10	53,95 53,96 53,97	NX30002 NX30002-B NX30002-C	68,96	N09B0131	8,65	NX20000R	9,53	NX30003T (04-07)	20,44	NX30003F	64,82
DR 200	86-09								NX30011T	24,62	NX30011F	55,37
DR-Z 250	01-07								NX30043T	39,23	NX30043F	59,23
RM 250	84-85								NX30025T	14,48	NX30025F	35,14
RM 250 cilindro SCEM	89-91	66,94 66,95 66,96	NX30025 NX30025-B NX30025-C	98,11	N095031	9,70	NX30025R	16,80	NX30021T 1989 NX30022T 1990 NX30023T 1991	19,70 20,00 27,05	NX30021F 1989 NX30022F 1990	58,82 57,77
RM 250 cilindro SCEM	92-95	66,94 66,95 66,96	NX30025 NX30025-B NX30025-C	98,11	N095031	9,70	NX30025R	16,80	NX30026T (92-93) NX30027T (94-95)	15,17 23,48	NX30026F (92-93) NX30027F (94-95)	56,61 56,61
RM 250 cilindro SCEM	96-97	66,34 66,35 66,36	NX30026 NX30026-B NX30026-C	102,20	N095031	9,70	NX10025R	14,56	NX30028T	15,75	NX30028F	62,47
RM 250 cilindro SCEM	1998	66,35 66,36 66,37	NX30024 NX30024-B NX30024-C	82,55	N095031	9,70	NX10025R	14,56	NX30028T	15,75	NX30028F	62,47
RM 250 cilindro SCEM	1999	66,34 66,35 66,36	NX30026 NX30026-B NX30026-C	102,20	N095031	9,70	NX10025R	14,56	NX30029T	19,89	NX30029F	54,23
RM 250 cilindro SCEM	00-02	66,35 66,36 66,37	NX30024 NX30024-B NX30024-C	82,55	N095031	9,70	NX10025R	14,56	NX30029T (2000) NX30030T (01-02)	19,89 19,89	NX30029F (2000) NX30030F (01-02)	54,23 64,21
RM 250 cilindro nikasil	03-08	66,34 66,35 66,36 66,84 67,34 67,84	NX30027 NX30027-B NX30027-C NX30027-2 NX30027-4 NX30027-6	92,53	N095031	9,70	NX10025R NX10025R NX10025R NX10025-2R NX10025-4R NX10025-6R	14,56	NX30031T (03-05) NX30033T (06-08)	34,04 31,03	NX30033F (03-08)	56,28
RMX 250	89-98				N095031	9,70			NX30035T	24,51	NX30035F	58,77
RM-Z 250 piston forjado cilindro SCEM	04-06	76,95 76,96 76,97	NX20030 NX20030-B NX20030-C	171,90			NX20030R	15,58	NX20030T	71,42	NX20030F	83,99

** Pistón o aros Namura no son intercambiables por aros o pistones originales. / [En Azul pistones Hyperdryve.](#)



Kit de pistón y juntas

			PISTÓN, SEGMENTOS, BULÓN, CIRCLIPS	RODAMIENTO PISTÓN	SEGMENTOS	JUNTAS CILINDRO	JUNTAS MOTOR			
RM-Z 250 compr. 13.4:1	07-09	76,96 76,97 76,98	NX30013 NX30013-B NX30013-C	142,56	NX30013R	18,26	NX30038T	50,56	NX30038F	104,68
RM-Z 250 compr. 13.4:1	10-14	77,00 77,01 77,02	NX30014 NX30014-B NX30014-C	142,84	NX30013R	18,26	NX30039T	52,00	NX30039F	104,68
DR-Z 400 compr. cilindro nikasil	00-16	89,96 89,97 89,98 90,46 90,96 91,46	NA30002 NA30002-B NA30002-C NA30002-2 NA30002-4 NA30002-6	135,63	NA30002R NA30002R NA30002R NA30002-2R NA30002-4R NA30002-6R	25,58	NA30002T	48,76	NX30041F	100,59
RM-Z 450 compr. 12.0:1	05-07	95,46 95,47 95,48	NX30015 NX30015-B NX30015-C	171,93	NX30015R	24,37	NX30045T	61,03	NX30045F	114,19
RM-Z 450 RNX 450 compr. 12.5:1	08-12 10-11	95,95 95,96 95,97	NX30016 NX30016-B NX30016-C	180,19	NX30016R	24,37	NX30046T	69,84	NX30046F	130,05
DR 650 SE	96-13						NX30049T	39,51	NX30049F	71,17

			PISTÓN, SEGMENTOS, BULÓN, CIRCLIPS	RODAMIENTO PISTÓN	SEGMENTOS	JUNTAS CILINDRO	JUNTAS MOTOR					
YAMAHA	Año	Medidas (mm)	Referencia	€	Referencia	€	Referencia	€	Referencia	€		
PW 50 compres.	81-16	39,96 40,21 40,46 40,71 40,96 41,21 41,40	NX40005 NX40005-1 NX40005-2 NX40005-3 NX40005-4 NX40005-5 NX40005-6	62,16	N09B410	4,37	NX40005R NX40005-1R NX40005-2R NX40005-3R NX40005-4R NX40005-5R NX40005-6R	12,20	NX40055T (90-16)	4,97	NX40055F (90-16)	10,94
BW 80 PW 80 compr. 6.6:1	86-90 83-06	46,97 47,47 47,97 48,47	NX40008 NX40008-2 NX40008-4 NX40008-6	57,55	N09B0422	7,29	NX40008R NX40008-2R NX40008-4R NX40008-6R	11,24	NX40008T	12,07	NX40008F	23,51
YZ 80 compr. 8.2:1 cilindro ceramico	93-01	46,95 46,96 46,97 47,44 48,00 48,50	NX40080 NX40080-B NX40080-C NX40080-2 NX40080-4 NX40080-6	72,17	N09B0121	7,29	NX10080R NX10080R NX10080R NX10080-2R NX10080-4R NX10080-6R	7,35	NX40080T	15,09	NX40080F	25,64
YZ 85 compr. 8.2:1 cilindro ceramico	02-16	47,44 47,45 47,46 48,00 48,50	NX40080-2 NX40080-2B NX40080-2C NX40080-4 NX40080-6	72,17	N09B0121	7,29	NX10080-2R NX10080-2R NX10080-2R NX10080-4R NX10080-6R	7,35	NX40085T	15,75	NX40085F	34,98
DTR 125 R DTX 125	91-06	55,98 56,23 56,48 56,73 56,98 57,43 57,98	NX40011 NX40011-1 NX40011-2 NX40011-3 NX40011-4 NX40011-6 NX40011-8	46,50	N095021	8,16	NX40011R NX40011-1R NX40011-2R NX40011-3R NX40011-4R NX40011-6R NX40011-8R	10,03	NX40011T (99-06)	29,70	NX40011F (99-06)	58,71
WR 125 R WR 125 X	09-11 09-11								NX40093T	37,38	NX40093F	92,03
YZ 125	86-88								NX40001T	13,26	NX40001F	41,06
YZ 125	1989								NX40002T	13,26	NX40003F	39,18
YZ 125	90-91								NX40003T	13,12	NX40003F	39,18
YZ 125	92-93								NX40004T	16,94	NX40004F	40,61
YZ 125	94-96								NX40005T	16,94	NX40005F	43,49
YZ 125 compr. 8.9:1 cilindro ceramico	97-01	53,94 53,95 53,96	NX10003 NX10003-B NX10003-C	68,49	N09B0381 (98-00) N09B0011 (2001)	8,65 7,29	NX20000R	9,53	NX40005T (1997) NX40000T (98-01)	16,94 21,99	NX04005F (1997) NX40000F (98-01)	43,49 38,96
YZ 125** compr. 10.8:1 cilindro ceramico	02-04	53,94 53,95 53,96	NX40001 NX40001-B NX40001-C	79,43	N09B0011	7,29	NX20000R	9,53	NX40007T	20,80	NX40007F	43,24
YZ 125** compr. 10.7:1 cilindro ceramico	05-14	53,95 53,96 53,97	NX40009 NX40009-B NX40009-C	68,96	N09B0011	7,29	NX20000R	9,53	NX40009T	24,06	NX40009F	41,33
TT-R 125	05-13								NA40020T	34,23	NA40020F	61,03
TW 200	87-11	67,00							NX40020T	34,23	NX40020F	61,03
TTR 225	99-04								NX40022T	35,25	NX40022F	67,50
XT 225	93-07								NX40022T	35,25	NX40022F	67,50

** Pistón o aros Namura no son intercambiables por aros o pistones originales. / En Azul pistones Hyperdryve.



Kit de pistón y juntas



		PISTÓN, SEGMENTOS, BULÓN, CIRCLIPS			RODAMIENTO PISTÓN		SEGMENTOS		JUNTAS CILINDRO		JUNTAS MOTOR	
TTR 230	05-12								NX40022T	35,25	NX40022F	67,50
WR 250 compr. 10.6:1 cilindro ceramico	92-98	67,94 67,95 67,96	NX40026 NX40026-B NX40026-C	96,15			NX40026R	19,48				
WR 250 F	01-02								NX40032T	43,29	NX40032F	66,72
WR 250 F	03-04								NX40032T	43,29	NX40036F	68,79
WR 250 F	05-13	76,94 76,95 76,96	NX40033 NX40033-B NX40033-C	174,78			NX20030R	15,58	NX40032T	43,29	NX40036F	68,79
WR 250 F	2015								NX40037T	84,13	NX40037F	163,86
YZ 250 compr. 10.6:1 cilindro ceramico	92-98	67,94 67,95 67,96	NX40026 NX40026-B NX40026-C	96,15	N095031	9,70	NX40026R	19,48	NX40026T (90-94) NX40029T (95-98)	21,99 21,69	NX40026F (90-94) NX40029F (95-98)	44,29 42,33
YZ 250 compr. 10.9:1 cilindro ceramico	99-17	66,35 66,36 66,37 66,85 67,35 67,85	NX40025 NX40025-B NX40025-C NX40025-2 NX40025-4 NX40025-6	91,78	N0950501	9,70	NX10025R NX10025R NX10025R NX10025-2R NX10025-4R NX10025-6R	14,56	NX40025T (99-01) NX40031T (02-17)	18,12 25,28	NX40025F (99-00) NX40031F (02-17)	45,39 44,84
YZ 250 F	01-04								NX40032T	43,29	NX40032F	66,72
YZ 250 F	05-13	76,94 76,95 76,96	NX40033 NX40033-B NX40033-C	174,78			NX20030R	15,58	NX40032T	43,29	NX40032F	66,72
YZ 250 F	14-16								NX40037T	84,13	NX40037F	163,86
YZ 250 X cilindro ceramico compr. 10.9:1	16-17	66,35 66,36 66,37 66,85 67,35 67,85	NX40025 NX40025-B NX40025-C NX40025-2 NX40025-4 NX40025-6	91,78	N0950501	9,70	NX10025R NX10025R NX10025R NX10025-2R NX10025-4R NX10025-6R	14,56	NX40031T	25,25	NX40031F	44,84
WR 400 F	98-99								NX40040T	55,15	NX40040F	80,87
WR 400 F	2000								NX40041T	54,37	NX40041F	86,92
YZ 400 F	98-99								NX40040T	55,15	NX40040F	80,87
WR 426 F	01-02								NX40041T	54,37	NX40041F	86,92
YZ 426 F	00-02								NX40041T	54,37	NX40041F	86,92
WR 450 F YZ 450 F compr. 12.5:1	03-06 03-05	94,95 94,96 94,97	NX40045 NX40045-B NX40045-C	179,75			NA40009R	25,39	NA40009T	24,06	NX40045F	81,64
WR 450 F YZ 450 F compr. 12.5:1	07-15 06-09	94,95 94,96 94,97	NX40045 NX40045-B NX40045-C	179,75			NA40009R	25,39	NX40046T	44,37	NX40046F	73,19
WR 450 F	2016		NX40048 NX40048-B NX40048-C	191,82			NX40046R	31,22	NX40048T	90,68	NX40048F	130,29
YZ 450 F compr. 12.5:1	10-13	94,95 94,96 94,97	NX40046 NX40046-B NX40046-C	178,84			NX40046R	31,22	NX40047T	60,42	NX40047F	94,76
YZ 450 F	14-17		NX40048 NX40048-B NX40048-C	191,82			NX40046R	31,22	NX40048T	90,68	NX40048F	130,29
TT 600 TT 600 R XT 600 XTZ 600	84-04	95,00 95,50 96,00	NA40007 NA40007-2 NA40007-4	128,33			NA40007R NA40007-2R NA40007-4R	25,58	NA40007T YTZ600 (84-86) XT600 (88-95)	20,80		
XTZ 660	91-97	99,97 100,47 100,97 101,47	NA40004 NA40004-2 NA40004-4 NA40004-6	123,94			NA40004R NA40004-2R NA40004-4R NA40004-6R	27,79	NX40092T	93,82		

RUEDAS Y NEUMÁTICOS

MOTOR

ADMISIÓN / ESCAPE
REFRIGERACIÓN

ELECTRICO

SUSPENSIÓN / DIRECCIÓN

FRENOS

TRANSMISIÓN

CONTROLES Y MANDOS

CHASIS

ACCESORIOS



AIRSAL Cilindros



DMX091502K



03420477



03410176

			PSYCHIC		AIRSAL	
GAS GAS	Año	Descripción	Referencia	€	Referencia	€
EC 250	10-15	Std. 77 mm	DMX091502	167,69	03127177	243,06
HONDA						
CRF 250 R	04-09	Std. 78 mm (249cc)	DMX09152	167,69	03047478	243,06
CRF 250 R	04-09	Dimensionado 82 mm (de 249cc a 290cc)	DMX091522	208,87		
CRF 250 R	10-17	Std. 76,8 mm			030475768	243,06
CRF 250 X	04-16	Std. 78 mm (249cc)	DMX09152	167,69	03047478	243,06
CRF 250 X	04-16	Dimensionado 82 mm (de 249cc a 290cc)	DMX091522	208,87		
CRF 450 F	02-08	Std. 96 mm	DMX09158	209,62		
CRF 450 F	02-08	Dimensionado a 100 mm	DMX091581	233,03		
CRF 450 F	09-16	Std. 96 mm	DMX09171	231,83		
CRF 450 X	05-16	Std. 96 mm	DMX09172	231,83		
KAWASAKI						
KX 250 F	04-08	Std. 77 mm			03420177	234,89
KX 250 F	2009	Std. 77 mm			03420277	234,89
KX 250 F	2010	Std. 77 mm			03420377	234,89
KX 250 F	11-17	Std. 77 mm			03420477	234,89
KTM						
250 EXC-F	07-13	Std. 76 mm			03410176	234,89
250 SX-F	05-12	Std. 76 mm			03410176	234,89
250 XC-F	06-12	Std. 76 mm			03410176	234,89
250 XCF-W	06-13	Std. 76 mm			03410176	234,89
SUZUKI						
RM-Z 250	04-06	Std. 77 mm			03420177	234,89
RM-Z 250	07-09	Std. 77 mm			03052477	234,89
RM-Z 250	10-17	Std. 78 mm			03052577	234,89
YAMAHA						
WR 125 R	09-14	Std. 52 mm	DMX09155	173,63		
WR 125 X	09-14	Std. 52 mm	DMX09155	173,63		
YZF-R 125	08-16	Std. 52 mm	DMX09155	173,63		
WR 250 F	01-14	Std. 77 mm	DMX091502	167,69	03127177	243,06
WR 250 F	01-14	Dimensionado 83 mm (de 250cc a 290cc)	DMX09150	208,87		
YZ 250 F	01-13	Std. 77 mm	DMX091502	167,69	03127177	243,06
YZ 250 F	01-13	Dimensionado 83 mm (de 250cc a 290cc)	DMX09150	208,87		
WR 450 F	03-06	Std. 95 mm	DMX09151	209,62		
WR 450 F	03-06	Dimensionado 98 mm (de 449cc a 478cc)	DMX091511	233,03		
WR 450 F	07-15	Std. 95 mm	DMX09159	220,86		
WR 450 F	07-15	Dimensionado 98 mm (de 449cc a 478cc)	DMX091591	233,03		
WR 450 F	16-17	Std. 97 mm	DMX09173			
YZ 450 F	03-05	Std. 95 mm	DMX09151	209,62		
YZ 450 F	03-05	Dimensionado 98 mm (de 449cc a 478cc)	DMX091511	233,03		
YZ 450 F	06-09	Std. 95 mm	DMX09159	220,86		
YZ 450 F	06-09	Dimensionado 98 mm (de 449cc a 478cc)	DMX091591	233,03		
YZ 450 F	14-17	Std. 97 mm	DMX09173	231,83		



Kits de cilindro Pistones y juntas de recambio

XR 400 (96-04)
DAT09463K*



Lo más rápido, fiable y económico, sustituir el cilindro y pistón por el kit de cilindrada, ahorrarás tiempo y dinero, pero también aumentarás cilindrada, convirtiendo tu vieja moto en un vehículo con nuevas prestaciones. El pistón Namura supera ampliamente las características y calidades originales. Los cilindros pueden ser normales, de nikasil o cerámicos, según sea el original, como mínimo de la misma calidad que el original. El Kit se entrega con cilindro, pistón, segmentos, bulón, circlips y kit de juntas.

* DAT09463K Es necesario mandrinar 0,8mm el cárter para poder alojar la camisa.

** DAT094621K Usar la junta de culata delgada (la gruesa solo para Quad).



YZ 250 F (05-13)
DMX091502K



DR-Z 400 (00-15)
DAT094621K**

			KIT DE CILINDRO		KIT PISTÓN RECAMBIO		JUNTAS RECAMBIO	
GAS GAS	Año	Descripción	Referencia	€	Referencia	€	Referencia	€
EC 250 F	10-15	77 mm	DMX091502K	341,44	NX40033	174,78	NX40032T	43,29
HONDA								
CRF 250 R	04-09	Std. 78 mm (249cc)	DMX09152K	341,44				
CRF 250 X	04-16	Std. 78 mm (249cc)	DMX09152K	341,44				
XR 400	96-04	89 mm (de 400 a 440cc)	DAT09463K*	333,60	NA10004	123,25	NA10004T	52,66
CRF 450 R	02-06	Std. 96 mm	DMX09158K	394,98	NX10045	174,25	NX10045T	60,62
CRF 450 R	07-08	Std. 96 mm	DMX09149K	394,98	NX10045	174,25	NX10046T	61,58
CRF 450 R	09-12	Std. 96 mm	DMX09171K	458,97	NX10046	171,96	NX10048T	72,17
CRF 450 R	13-16	Std. 96 mm	DMX09174K	458,97	NX10048	180,80	NX10048T	72,17
CRF 450 X	05-16	Std. 96 mm	DMX09172K	458,97	NX10045	174,25	NX10046T	61,58
KAWASAKI								
KLX 400	03-05	94 mm (de 400 a 435cc)	DAT094621K**	396,92	NA30002-16	138,06	NA3000216T	78,60
					NA3000216B	138,06	NA3000216T	78,60
					NA3000216C	138,06	NA3000216T	78,60
SUZUKI								
DR-Z 400	00-15	94 mm (de 400 a 435cc)	DAT094621K**	396,92	NA30002-16	138,06	NA3000216T	78,60
					NA3000216B	138,06	NA3000216T	78,60
					NA3000216C	138,06	NA3000216T	78,60
YAMAHA								
WR 250 F	05-13	Std. 77 mm (250cc)	DMX091502K	341,44	NX40033	174,78	NX40032T	43,29
WR 250 F	01-13	83 mm (de 250 a 290cc)					NX4003224T	84,38
YZ 250 F	05-13	Std. 77 mm (250cc)	DMX091502K	341,44	NX40033	174,78	NX40032T	43,29
YZ 250 F	05-13	83 mm (de 250 a 290cc)					NX4003224T	84,38
WR 450 F	03-06	Std. 95 mm (449cc)	DMX09151K	394,98	NX40045	179,75	NA40009T	55,23
WR 450 F	07-15	Std. 95 mm (449cc)	DMX09159K	394,98	NX40045	179,75	NX40046T	44,37
YZ 450 F	03-05	Std. 95 mm (449cc)	DMX09151K	394,98	NX40045	179,75	NA40009T	55,23
YZ 450 F	06-09	Std. 95 mm (449cc)	DMX09159K	394,98	NX40045	179,75		
YZ 450 F	14-17	Std. 97 mm	DMX09173K	465,36	NX40048	191,82	NX40048T	90,68

RUEDAS Y NEUMÁTICOS

MOTOR

ADMISIÓN / ESCAPE
REFRIGERACIÓN

ELECTRICO

SUSPENSIÓN / DIRECCIÓN

FRENOS

TRANSMISIÓN

CONTROLES Y MANDOS

CHASIS

ACCESORIOS

Válvulas de admisión y escape racing

Válvulas de acero inoxidable forjadas y extremadamente ligeras de calidad superior a las originales. Para nuestras válvulas racing recomendamos el montaje de nuestros muelles Pag. 32. Se sirven en cajas de una unidad.



		VÁLVULAS DE ADMISIÓN		VÁLVULAS DE ESCAPE	
BETA					
Año	Referencia	€	Referencia	€	
RR 400 Enduro	05-09	DXU09548i	26,23	DXU09548E	25,40
RR 450 Enduro	05-09	DXU09548i	26,23	DXU09548E	25,40
RR 525 Enduro	05-09	DXU09548i	26,23	DXU09548E	25,40
GAS GAS					
Año	Referencia	€	Referencia	€	
EC 250 F	10-15	DXU09519i*	24,61	DXU09519E	23,78
		DXU09522i	24,61		
EC 300 F	13-15	DXU09519i*	24,61	DXU09519E	23,78
		DXU09522i	24,61		
EC 450 F	13-15	DXU09521i*	24,61	DXU09521E	25,08
		DXU09524i	25,40		
HONDA					
Año	Referencia	€	Referencia	€	
CRF 150 F	03-05	DXU09543i	24,61	DXU09543E	23,78
CRF 150 F	06-15	DXU09544i	24,61	DXU09544E	23,78
CRF 150 R	07-15	DXU09545i	25,08	DXU09545E	25,08
CRF 230 F	03-15	DXU09543i	24,61	DXU09543E	23,78
CRF 230 L	03-15	DXU09543i	24,61	DXU09543E	23,78
CRF 250 R	04-07	DXU09526i	24,57	DXU09526E	24,29
CRF 250 R	08-09	DXU09526i	24,57	DXU09526E	25,40
CRF 250 R	10-15	DXU09532i	23,78	DXU09532E	25,40
CRF 250 X	04-09	DXU09526i	24,57	DXU09526E	24,29
CRF 450 R	02-06	DXU09502i	24,61	DXU09502E	23,78
CRF 450 R	07-08	DXU09502i	24,61	DXU09501E	23,78
CRF 450 R	09-12	DXU09533i	24,29	DXU09533E	23,78
CRF 450 R	13-15	DXU09533i	24,29	DXU09546E	24,61
CRF 450 X	05-09	DXU09503i	24,61	DXU09503E	24,29
HUSABERG					
Año	Referencia	€	Referencia	€	
FE 250	2013	DXU09550i	25,08	DXU09550E	24,29
FE 350	13-14	DXU09555i	26,44	DXU09555E	26,56
FE 450	04-08	DXU09548i	26,23	DXU09548E	25,40
FE 550	04-08	DXU09548i	26,23	DXU09548E	25,40
FE 650	04-08	DXU09548i	26,23	DXU09548E	25,40
FS 650	04-08	DXU09548i	26,23	DXU09548E	25,40
HUSQVARNA					
Año	Referencia	€	Referencia	€	
FE 350	14-16	DXU09555i	26,44	DXU09555E	25,56
FC 350	14-16	DXU09555i	26,44	DXU09555E	25,56

		VÁLVULAS DE ADMISIÓN		VÁLVULAS DE ESCAPE	
KAWASAKI					
Año	Referencia	€	Referencia	€	
KX 250 F	04-06	DXU09509i	24,29	DXU09509E	24,29
KX 250 F	07-08	DXU09552i	24,50	DXU09509E	24,29
KX 250 F	09-16	DXU09515i	24,29	DXU09509E	24,29
KX 450 F	06-08	DXU09164i	21,16	DXU09164E	20,53
KX 450 F	09-15	DXU09528i	24,29	DXU09528E	23,78
KTM					
Año	Referencia	€	Referencia	€	
250 EXC-F	07-13	DXU09550i	25,08	DXU09550E	24,29
250 SX-F	05-12	DXU09550i	25,08	DXU09550E	24,29
350 EXC-F	12-16	DXU09555i	26,44	DXU09555E	25,56
350 SX-F	11-12	DXU09555i	26,44	DXU09555E	25,56
350 SX-F	13-15	DXU09555i	26,44	DXU09555E	25,56
350 XC-F	11-15	DXU09555i	26,44	DXU09555E	25,56
350 XCF-W	12-16	DXU09555i	26,44	DXU09555E	25,56
450 EXC	03-07	DXU09548i	26,23	DXU09548E	25,40
520 SX	00-02	DXU09548i	26,23	DXU09548E	25,40
525 SX	03-07	DXU09548i	26,23	DXU09548E	25,40
SUZUKI					
Año	Referencia	€	Referencia	€	
RMZ 250	04-06	DXU09509i	24,29	DXU09509E	24,29
RMZ 250	07-09	DXU09530i	25,40	DXU09530E	25,40
RMZ 250	10-15	DXU09531i	25,40	DXU09530E	25,40
RMZ 250	16-17	DXU09531i	25,40	DXU09530E	25,40
RM-Z 450	05-06	DXU09536i	24,61	DXU09536E	23,78
RM-Z 450	2007	DXU09535i	24,61	DXU09535E	23,78
RM-Z 450	08-17	DXU09527i	24,29	DXU09527E	23,78
RMX 450	10-11	DXU09527i	24,29	DXU09527E	23,78
YAMAHA					
Año	Referencia	€	Referencia	€	
WR 250 F	01-13	DXU09519i*	24,61	DXU09519E	23,78
		DXU09522i	24,61		
YZ 250 F	01-13	DXU09519i*	24,61	DXU09519E	23,78
		DXU09522i	24,61		
YZ 250 F	14-17	DXU09553i	24,29	DXU09553E	23,78
WR 450 F	03-15	DXU09521i*	24,61	DXU09521E	25,08
		DXU09524i	25,40		
YZ 450 F	03-09	DXU09521i*	24,61	DXU09521E	25,08
		DXU09524i	25,40		
YZ 450 F	10-13	DXU09541i	25,40	DXU09541E	24,61
YZ 450 F	14-17	DXU09554i	25,40	DXU09554E	24,61

* Válvula admisión central

Válvulas de admisión y escape

Válvulas ligeras de calidad superior o igual a las originales. Se sirven en cajas de una unidad.

		VÁLVULAS DE ADMISIÓN		VÁLVULAS DE ESCAPE	
HONDA					
Año	Referencia	€	Referencia	€	
CRF 70 F	04-12	DAU09000i1	16,65	DAU09000E1	19,22
XR 70 R	97-03	DAU09000i1	16,65	DAU09000E1	19,22
XR 200 R	80-02	DXU09500i	18,03	DXU09500E	18,03
XR 400 R	96-08	DAU09011i	19,30	DAU09011E	22,95
XL 600 R	83-84	DXU09504i	23,33	DXU09504E	23,33
XL 600 R	85-00	DXU09504i	23,33	DXU09504E	23,33
XR 600 R	83-00	DXU09504i	23,33	DXU09504E	23,33
XR 650 L	93-16	DXU09504i	23,33	DXU09504E	23,33
KAWASAKI					
Año	Referencia	€	Referencia	€	
KLR 250	85-05	DAU09022i	18,50	DAU09022E	21,35
KLX 400 R	03-05	DAU09025i	18,90	DAU09025E1	23,75

		VÁLVULAS DE ADMISIÓN		VÁLVULAS DE ESCAPE	
SUZUKI					
Año	Referencia	€	Referencia	€	
DR 350	90-00	DAU09033i	19,10	DAU09033E	20,08
DR-Z 400 E	00-07	DAU09025i	18,90	DAU09025E	23,75
DR-Z 400 S	00-14	DAU09025i	18,90	DAU09025E	23,75
DR 650 SE	96-15	DAU09032i	18,50	DAU09032E	22,05
YAMAHA					
Año	Referencia	€	Referencia	€	
TW 200	87-17	DXU09518i	18,58	DXU09518E	20,29
TT-R 225 R	99-04	DXU09518i	18,58	DXU09518E	20,29
XT 225	92-07	DXU09518i	18,58	DXU09518E	20,29
TT-R 230	05-16	DXU09518i	18,58	DXU09518E	20,29
XT 250	08-17	DXU09518i	18,58		



Especificaciones válvulas

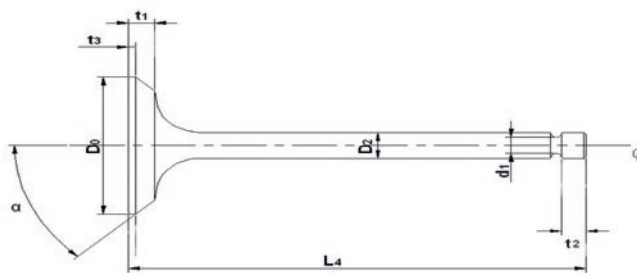

Tolerancia (mm)	+/-0.10	----	+/-0.20	+/-0.01	+/-0.15	+/-0.20	+/-0.05	+/-0.10
Referencia	D0	α	L4	D2	t3	t1	d1	t2
DXU09164E	31.00mm	45°	81.99mm	5.36mm	1.0mm	2.6mm	4.6mm	1.8mm
DXU09164I	35.94mm	45°	83.29mm	5.39mm	0.9mm	2.6mm	4.6mm	1.8mm
DXU09500E	25mm	45°	91.5mm	5.4mm	1.3mm	2.7mm	4.55mm	6.0mm
DXU09500I	30mm	45°	92mm	5.46mm	1.1mm	2.7mm	4.55mm	6.0mm
DXU09501E	30mm	45°	84.3mm	4.98mm	1.0mm	2.3mm	4.3mm	1.5mm
DXU09502E	26mm	45°	82.1mm	4.96mm	1.0mm	2.7mm	4.2mm	1.5mm
DXU09502I	36mm	45°	84.75mm	5.49mm	1.5mm	2.9mm	4.7mm	1.5mm
DXU09503E	30mm	45°	84.5mm	4.97mm	1.2mm	2.7mm	4.3mm	1.5mm
DXU09503I	35mm	45°	84.6mm	5.45mm	1.0mm	2.7mm	4.75mm	1.5mm
DXU09504E	31mm	45°	104.2mm	6.56mm	1.8mm	3.5mm	5.45mm	3.2mm
DXU09504I	36mm	45°	105.6mm	6.58mm	1.0mm	3.3mm	5.5mm	5.7mm
DXU09509E	25mm	45°	79.2mm	4.46mm	1.0mm	2.3mm	3.8mm	1.5mm
DXU09509I	31mm	45°	79mm	4.48mm	1.0mm	2.5mm	3.8mm	1.5mm
DXU09515I	31mm	45°	79.3mm	4.47mm	1.0mm	2.5mm	3.75mm	1.5mm
DXU09519E	24.5mm	45°	77.9mm	4.46mm	1.0mm	2.1mm	3.5mm	2.1mm
DXU09519I	23mm	45°	78.6mm	3.99mm	0.8mm	2.1mm	2.9mm	1.5mm
DXU09521E	28mm	45°	75mm	4.96mm	1.0mm	2.8mm	4.1mm	1.8mm
DXU09521I	27mm	45°	76.3mm	4.48mm	1.0mm	2.7mm	3.46mm	1.8mm
DXU09522I	23mm	45°	80.1mm	3.98mm	1.0mm	2.2mm	3.0mm	1.5mm
DXU09524I	27mm	45°	77.2mm	4.9mm	1.0mm	2.7mm	3.48mm	2.0mm
DXU09526E	26mm	45°	82.2mm	4.46mm	1.0mm	2.5mm	3.8mm	1.5mm
DXU09526I	31mm	45°	83.4mm	4.97mm	1.0mm	2.3mm	4.2mm	1.5mm
DXU09527E	31mm	45°	80.9mm	5.46mm	1.0mm	3.0mm	4.6mm	2.0mm
DXU09527I	35.9mm	45°	81.9mm	5.48mm	1.0mm	3.0mm	4.6mm	2.0mm
DXU09528E	31mm	45°	77mm	5.46mm	1.2mm	3.0mm	4.65mm	2.0mm
DXU09528I	36mm	45°	78.2mm	5.47mm	1.2mm	2.8mm	4.7mm	2.0mm
DXU09530E	25mm	45°	80.7mm	4.46mm	1.0mm	2.3mm	3.55mm	2.1mm
DXU09530I	30.9mm	45°	80.4mm	4.47mm	1.0mm	2.7mm	3.5mm	2.1mm
DXU09531I	31mm	45°	80.2mm	4.48mm	1.0mm	2.7mm	3.55mm	1.5mm
DXU09532E	25mm	45°	84.2mm	4.46mm	1.0mm	2.3mm	3.8mm	1.2mm
DXU09532I	30.5mm	45°	89.1mm	4.98mm	1.0mm	2.5mm	4.2mm	1.2mm
DXU09533E	30mm	45°	80.6mm	4.97mm	1.2mm	2.5mm	4.2mm	1.2mm
DXU09533I	36mm	45°	78.65mm	4.98mm	1.2mm	3.1mm	4.2mm	1.2mm
DXU09534E	31mm	45°	84.3mm	4.97mm	1.0mm	2.7mm	4.2mm	1.5mm
DXU09535E	29mm	45°	81.4mm	5.46mm	1.2mm	2.3mm	4.55mm	2.0mm
DXU09535I	36mm	45°	82.5mm	5.48mm	1.2mm	3.0mm	4.55mm	2.0mm
DXU09536E	29mm	45°	81.3mm	4.98mm	1.1mm	2.7mm	4.0mm	1.8mm
DXU09536I	36mm	45°	82.5mm	4.98mm	1.1mm	2.7mm	4.0mm	1.8mm
DXU09541E	29.95mm	45°	85.95mm	5.39mm	1.2mm	2.8mm	4.6mm	1.8mm
DXU09541I	35.98mm	45°	83.68mm	5.42mm	1.1mm	3mm	4.55mm	1.8mm
DXU09543E	27.00mm	45°	89.35mm	5.34mm	1.3mm	3.0mm	4.75mm	2.6mm
DXU09543I	31.46mm	45°	89.7mm	5.40mm	0.8mm	2.3mm	4.75mm	2.8mm
DXU09544E	25.90mm	45°	82.63mm	4.94mm	1.0mm	2.5mm	4.3mm	1.8mm
DXU09544I	29.33mm	45°	83.4mm	4.89mm	0.8mm	2.2mm	4.3mm	1.8mm
DXU09545E	22.50mm	45°	79.95mm	4.40mm	0.8mm	2.2mm	3.8mm	1.0mm
DXU09545I	25.92mm	45°	77.98mm	4.44mm	1.0mm	2.3mm	3.8mm	1.5mm
DXU09546E	30.95mm	45°	80.50mm	4.89mm	1.0mm	2.7mm	4.3mm	1.4mm
DXU09548E	29.96mm	45°	96.92mm	5.92mm	1.2mm	2.8mm	5.0mm	1.5mm
DXU09548I	35.01mm	45°	96.99mm	5.92mm	1.1mm	3.0mm	4.9mm	1.5mm
DXU09550E	26.60mm	45°	92.90mm	4.91mm	1.1mm	2.5mm	3.9mm	1.4mm
DXU09550I	30.99mm	45°	99.49mm	4.89mm	1.0mm	2.5mm	3.95mm	1.2mm
DXU09552I	30.98mm	45°	79.13mm	4.49mm	0.8mm	1.8mm	3.8mm	1.2mm
DXU09553E	25mm	45°	82.4mm	4.47mm	0.8mm		3.5mm	
DXU09553I	31mm	45°	83.6mm	4.98mm	1.0mm		4.0mm	
DXU09554E	30.5mm	45°	85.8mm	5.465mm	0.8mm		4.5mm	
DXU09554I	37mm	45°	83.7mm	5.48mm	1.0mm		4.5mm	
DXU09555E	29mm	45°	89.25mm	5.46mm				
DXU09555I	36mm	45°	87.20mm	5.47mm				

RUEDAS Y NEUMÁTICOS

MOTOR

ADMISIÓN / ESCAPE
REFRIGERACIÓN

ELECTRICO

SUSPENSIÓN / DIRECCIÓN

FRENOS

TRANSMISIÓN

CONTROLES Y MANDOS

CHASIS

ACCESORIOS

Muelles para válvulas racing



Muelles reforzados con tratamiento de calor para aumentar la durabilidad. Se sirven en cajas de una unidad.

GAS GAS	Año	Admisión	€	Escape	€
EC 250 F	10-15	DXU09519IS	4,67	DXU09519ES	4,78
EC 300 F	13-15	DXU09519IS	4,67	DXU09519ES	4,78
EC 450 F	13-15	DXU09521S	4,78	DXU09521S	4,78

HONDA	Año	Admisión	€	Escape	€
CRF 150 F	03-05	DXU09543S	17,30	DXU09543S	17,30
CRF 150 F	06-15	DXU09544S	6,04	DXU09544S	6,04
CRF 150 R	07-15	DXU09545IS	5,74	DXU09545ES	6,11
CRF 230 F	03-15	DXU09543S	17,30	DXU09543S	17,30
CRF 230 L	08-09	DXU09543S	17,30	DXU09543S	17,30
CRF 250 R	04-07	DXU09526IS	5,15	DXU09503ES	6,33
CRF 250 R	08-09	DXU09526IS	5,15	DXU09526ES	5,08
CRF 250 R	10-15	DXU09532IS	5,30	DXU09532ES	5,81
CRF 250 X	04-09	DXU09526IS	5,15	DXU09503ES	6,33
CRF 450 R	02-08	DXU09502IS	5,63	DXU09502ES	5,81
CRF 450 R	09-15	DXU09533IS	5,63	DXU09533ES	6,00
CRF 450 X	05-09	DXU09503IS	9,31	DXU09537ES	10,05

HUSABERG	Año	Admisión	€	Escape	€
FE 250	2013	DXU09551ES	5,37	DXU09551ES	5,37
FE 350	13-16	DXU09555S	8,20	DXU09555S	8,20

HUSQVARNA	Año	Admisión	€	Escape	€
FE 350	14-16	DXU09555S	8,20	DXU09555S	8,20
FC 350	14-16	DXU09555S	8,20	DXU09555S	8,20

KAWASAKI	Año	Admisión	€	Escape	€
KX 250 F	04-05	DXU09509IS	5,15	DXU09509ES	5,19
KX 250 F	07-08	DXU09552IS	5,92	DXU09509ES	5,67
KX 250 F	09-10	DXU09540IS	4,75	DXU09509ES	5,67
KX 250 F	11-16	DXU09539IS	4,86	DXU09509ES	5,67
KX 450 F	06-15	DXU09528IS	5,41	DXU09528ES	5,10

KTM	Año	Admisión	€	Escape	€
250 EXC-F	2007	DXU09550IS	9,27	DXU09550ES	9,27
250 EXC-F	08-13	DXU09551IS	5,89	DXU09551ES	5,37
250 EXC-F	08-12	DXU09551IS	5,89	DXU09551ES	5,37
250 SX-F	05-07	DXU09550IS	9,27	DXU09550ES	9,27
250 SX-F	08-12	DXU09551IS	5,89	DXU09551ES	5,37
350 EXC-F	12-16	DXU09555S	8,20	DXU09555S	8,20
350 SX-F	11-12	DXU09557S		DXU09557S	
350 SX-F	13-15	DXU09555S	8,20	DXU09555S	8,20
350 XC-F	11-12	DXU09557S		DXU09557S	
350 XC-F	13-15	DXU09555S	8,20	DXU09555S	8,20
350 XCF-W	12-16	DXU09555S	8,20	DXU09555S	8,20

SUZUKI	Año	Admisión	€	Escape	€
RM-Z 250	04-06	DXU09509IS	5,15	DXU09509ES	5,19
RM-Z 250	07-16	DXU09529IS	4,67	DXU09509ES	5,19
RM-Z 450	05-07	DXU09536IS	5,30	DXU09536ES	5,81
RM-Z 450	08-17	DXU09527IS	5,41	DXU09527ES	5,15
RMX 450	10-11	DXU09527IS	5,41	DXU09527ES	5,15

YAMAHA	Año	Admisión	€	Escape	€
TT-R 225	99-04	DAU09518S3		DAU09518S3	
TT-R 230	05-16	DAU09518S3		DAU09518S3	
WR 250 F	01-13	DXU09519IS	4,67	DXU09519ES	4,78
YZ 250 F	01-12	DXU09519IS	4,67	DXU09519ES	4,78
YZ 250 F	14-17	DXU09553IS	6,37	DXU09553ES	6,11
WR 450 F	03-15	DXU09521S	4,78	DXU09521S	4,78
YZ 450 F	03-09	DXU09521S	4,78	DXU09521S	4,78
YZ 450 F	10-13	DXU09541IS	5,37	DXU09541ES	4,56
YZ 450 F	14-17	DXU09541ES	4,56	DXU09541IS	5,37

Especificaciones de muelles

Tolerancia (mm)	+/-0.20	+/-0.50		
Referencia	Exterior x Interior x Grosor	Altura	nº Espirales	
DXU09502ES	23,5 x 16,5 x 3,6	41,5	7	
DXU09502IS	23,7 x 16,5 x 3,6	38,5	6,4	
DXU09503ES	20 x 13 x 3,3	42,8	9	
DXU09503IS	16 x 12 x 2	36,5	7	
DXU09505ES	17,85 x 13 x 2,4	45,45	10	
DXU09509ES	20 x 14 x 3	38,5	7	
DXU09509IS	20,2 x 14,2 x 3	39	7,3	
DXU09519ES	18 x 13 x 2,5	35,3	7	
DXU09519IS	15,7 x 11 x 2,3	34,5	7,6	
DXU09521S	19,2 x 14,2 x 2,5	35,5	6,5	
DXU09526ES	19,9 x 13 x 3,4	43	9	
DXU09526IS	18,9 x 13 x 2,9	39,3	8	
DXU09527ES	23 x 17 x 3	34,5	6	
DXU09527IS	25 x 18,5 x 3,3	35	6	
DXU09528ES	21 x 14,5 x 3,2	36	7	
DXU09528IS	21 x 14,4 x 3,3	37,5	7	
DXU09529IS	20,2 x 14,2 x 3	39,3	8	
DXU09532ES	19,88 x 13 x 3,3	47,5	9	

Tolerancia (mm)	+/-0.20	+/-0.50		
Referencia	Exterior x Interior x Grosor	Altura	nº Espirales	
DXU09532IS	18,8 x 13 x 2,9	42,7	9	
DXU09533ES	23,68 x 16,5 x 3,6	43	8	
DXU09533IS	23,3 x 16,5 x 3,3	41	7	
DXU09536ES	23 x 17 x 3	35	6	
DXU09536IS	24,95 x 18,6 x 3,2	36,5	6	
DXU09537ES	18,3 x 13,6 x 2,3 24,9 x 18,5 x 3,3	40 43,5	8 6	
DXU09539IS	23,1 x 16,1 x 3,5	35,5	6,5	
DXU09540IS	22,72 x 16,2 x 3,2	37,16	7	
DXU09541ES	19 x 13,4 x 2,8	36	7,3	
DXU09541IS	21,9 x 15,3 x 3,3	40,9	7,5	
DXU09545ES	19 x 12,6 x 3,3	44,5	9,25	
DXU09545IS	18,6 x 12,6 x 3	38,5	8,5	
DXU09550ES	21,8/25,6 x 14,7/18,4 x 3,6	40	6	
DXU09550IS	21,8/25,6 x 14,7/18,4 x 3,6	40	6	
DXU09551ES	23,2 x 17 x 3,1	35,5	5	
DXU09551IS	20,9 x 14,1 x 3,3	40,8	7	
DXU09552IS	22,4 x 16,05 x 3,2	37	7	
DXU09553ES	18,6 x 12,9 x 2,8	32,8	7,6	
DXU09553IS	20 x 14 x 3	36,8	7,5	



Caja de pastillas de reglaje

Referencia	Descripción	€
DMX0943100	Diámetro 7,48mm - Grosor de 120 a 350 - 141 unidades	145,95
DMX0943300	Diámetro 8,90mm - Grosor de 172 a 260 - 69 unidades	87,95
DMX0943200	Diámetro 9,48mm - Grosor de 120 a 350 - 141 unidades	155,95



Pastillas de reglaje (bolsa con 3 unidades)

Set de 3 unidades
Pastilla de 7,48mm

€
10,95



Set de 3 unidades
Pastilla de 9,48mm

€
10,95



Referencia	Medida
DMX0943101	120
DMX0943102	125
DMX0943103	130
DMX0943104	135
DMX0943105	140
DMX0943106	145
DMX0943107	150
DMX0943108	155
DMX0943109	160
DMX0943110	165
DMX0943111	170
DMX0943112	175
DMX0943113	180
DMX0943114	185
DMX0943115	190
DMX0943116	195
DMX0943117	200
DMX0943118	205
DMX0943119	210
DMX0943120	215
DMX0943121	220
DMX0943122	225
DMX0943123	230
DMX0943124	235

Referencia	Medida
DMX0943125	240
DMX0943126	245
DMX0943127	250
DMX0943128	255
DMX0943129	260
DMX0943130	265
DMX0943131	270
DMX0943132	275
DMX0943133	280
DMX0943134	285
DMX0943135	290
DMX0943136	295
DMX0943137	300
DMX0943138	305
DMX0943139	310
DMX0943140	315
DMX0943141	320
DMX0943142	325
DMX0943143	330
DMX0943144	335
DMX0943145	340
DMX0943146	345
DMX0943147	350

Referencia	Medida
DMX0943201	120
DMX0943202	125
DMX0943203	130
DMX0943204	135
DMX0943205	140
DMX0943206	145
DMX0943207	150
DMX0943208	155
DMX0943209	160
DMX0943210	165
DMX0943211	170
DMX0943212	175
DMX0943213	180
DMX0943214	185
DMX0943215	190
DMX0943216	195
DMX0943217	200
DMX0943218	205
DMX0943219	210
DMX0943220	215
DMX0943221	220
DMX0943222	225
DMX0943223	230
DMX0943224	235

Referencia	Medida
DMX0943225	240
DMX0943226	245
DMX0943227	250
DMX0943228	255
DMX0943229	260
DMX0943230	265
DMX0943231	270
DMX0943232	275
DMX0943233	280
DMX0943234	285
DMX0943235	290
DMX0943236	295
DMX0943237	300
DMX0943238	305
DMX0943239	310
DMX0943240	315
DMX0943241	320
DMX0943242	325
DMX0943243	330
DMX0943244	335
DMX0943245	340
DMX0943246	345
DMX0943247	350

Set de 3 unidades
Pastilla de 8,90mm

€
10,95

Referencia	Medida
DMX0943301	172
DMX0943302	176
DMX0943303	180
DMX0943304	184
DMX0943305	188
DMX0943306	192
DMX0943307	196
DMX0943308	200

Referencia	Medida
DMX0943309	204
DMX0943310	208
DMX0943311	212
DMX0943312	216
DMX0943313	220
DMX0943314	224
DMX0943315	228
DMX0943316	232

Referencia	Medida
DMX0943317	236
DMX0943318	240
DMX0943319	244
DMX0943320	248
DMX0943321	252
DMX0943322	256
DMX0943323	260



Bielas completas

Bielas completas con bulón de cigüeñal, separadores y rodamientos.

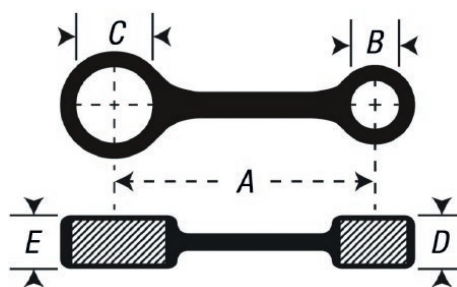

				BIELA					BULÓN		RODAMIENTO PISTÓN	RODAMIENTO BIELA
BETA	Año	Referencia	€	A	B	C	D	E	Ø	Largo	Medidas	Medidas
RR 250 Enduro	05-07	DMX09024	120,54	129	20	43	21,9	21,9	35	64,7		35 X 43 X 21.7
RR 450 Enduro	05-09	DMX09024	120,54	129	20	43	21,9	21,9	35	64,7		35 X 43 X 21.7
RR 525 Enduro	05-09	DMX09024	120,54	129	20	43	21,9	21,9	35	64,7		35 X 43 X 21.7
				BIELA					BULÓN		RODAMIENTO PISTÓN	RODAMIENTO BIELA
GAS GAS	Año	Referencia	€	A	B	C	D	E	Ø	Largo	Medidas	Medidas
EC 250	97-15	DMX09004	86,45	110	19	28	16	16	22	55		
EC 250 F	10-15	DMX09085	122,16	93,5	16	40	15	18	32	55		32X40X20
MC 250	97-15	DMX09004	86,45	110	19	28	16	16	22	55		
EC 300	00-15	DMX09004	86,45	125	22	30	17	17	24	60	18X22X19.8	24X30X16.8
				BIELA					BULÓN		RODAMIENTO PISTÓN	RODAMIENTO BIELA
HONDA	Año	Referencia	€	A	B	C	D	E	Ø	Largo	Medidas	Medidas
CR 80	86-02	DMX09000	61,01	97	18	26	14,2	14,2	20	45	14x18x.15.8	20x26x13.8
CR 85	03-07	DMX09000	61,01	97	18	26	14,2	14,2	20	45	14x18x.15.8	20x26x13.8
CR 125	88-07	DMX09003	81,39	104	19	29	16	16	22	54	15x19x16.8	22x29x15.8
CRF 150 R	07-17	DMX09046	88,39	75,5	14	32	14	16	25	50	25x32x16	
CRF 150 RB	07-17	DMX09046	88,39	75,5	14	32	14	16	25	50	25x32x16	
CRF 230 F	03-17	DMX09012	64,43	110	18	38	15	18	30	54		
CR 250	84-01	DMX09004	86,45	125,4	22	31	20	16,7	24	60	18x22x22.8	24x31x17
CR 250	02-07	DMX09009	88,68	125,3	22	32	20	16,5	25	59,5	18x22x22.8	25x32x16.5
CRF 250 R	04-17	DMX09138B	101,78	90	16	38	15	18	30	53	16x18x15	30x38x17.8
CRF 250 X	04-16	DMX09138B	101,78	90	16	38	15	18	30	53	16x18x15	30x38x17.8
XR 250	86-05	DMX09006	103,56	105	17	41	18	18	32	58		
CRF 450 R	02-08	DMX09011	128,56	105,5	19	42	18/13	20	34	61	34x42x19.8	34x42x19.8
CRF 450 R	09-16	DMX09088	143,29	102	19	41	18/15.2	19,8	33	60,8	33x41x19.8	
CRF 450 X	05-12	DAT09193	131,24	105,5	19	42	18/13	20	34	65	34x42x19.8	
CR 500	87-01	DMX09007	95,98	144	25	34	24	20	26	68	20x25x27.8	26x35x19.7
XR 600	01-02	DMX09005	139,28	134	24	48	23	23	38	65	38x48x22.8	38x48x22.8
XL 600	83-87	DMX09005	139,28	134	24	48	23	23	38	65	38x48x22.8	38x48x22.8
				BIELA					BULÓN		RODAMIENTO PISTÓN	RODAMIENTO BIELA
HUSABERG	Año	Referencia	€	A	B	C	D	E	Ø	Largo	Medidas	Medidas
TE 125	12-14	DMX09059	103,12	110	19	28	16	16	22	55		
FE 250	2014	DMX09022	115,04	98	16	30	15	18	30	56		
TE 250	11-14	DMX09047	144,48	125	22	30	17	17	24	60	18X22X19.8	24X30X16.8
TE 300	11-14	DMX09047	144,48	125	22	30	17	17	24	60	18X22X19.8	24X30X16.8
FE 350	13-14	DMX09018	120,54	102	18	40	17	20	32	60		
				BIELA					BULÓN		RODAMIENTO PISTÓN	RODAMIENTO BIELA
HUSQVARNA	Año	Referencia	€	A	B	C	D	E	Ø	Largo	Medidas	Medidas
CR 125	97-13	DMX09065	88,83	105	19	24	16	30	24	55,3		24x30x15.7
WR 125	97-13	DMX09065	88,83	105	19	24	16	30	24	55,3		24x30x15.7
TC 125	14-16	DMX09059	103,12	110	19	28	16	16	22	55		
TE 125	14-16	DMX09059	103,12	110	19	28	16	16	22	55		
CR 150	2011	DMX09065	88,83	105	19	24	16	30	24	55,3		24x30x15.7
FC 250	14-15	DMX09022	115,04	98	16	30	15	18	30	56		
FE 250	14-16	DMX09022	115,04	98	16	30	15	18	30	56		
TC 250	14-16	DMX09047	144,48	125	22	30	17	17	24	60	18X22X19.8	24X30X16.8
TE 250	14-16	DMX09047	144,48	125	22	30	17	17	24	60	18X22X19.8	24X30X16.8
TE 300	14-16	DMX09047	144,48	125	22	30	17	17	24	60	18X22X19.8	24X30X16.8
FC 350	14-16	DMX09023	140,45	102	32	18	17	20	32	60		
FE 350	14-16	DMX09023	140,45	102	32	18	17	20	32	60		
TC 610	91-98	DMX09103	205,20	127	24	38	22	18	30	60		30x38x17.8
TE 610	91-98	DMX09103	205,20	127	24	38	22	18	30	60		30x38x17.8



KAWASAKI	BIELA								BULÓN		RODAMIENTO PISTÓN	RODAMIENTO BIELA
	Año	Referencia	€	A	B	C	D	E	Ø	Largo	Medidas	Medidas
KX 60	83-03	DMX09026	68,75	85	16	27	14	14	20	46	12x16x15	20x27x13.8
KX 65	00-16	DMX09026	68,75	85	16	27	14	14	20	46	12x16x15	20x27x13.8
KDX 80	82-88	DMX09027	68,75	92	18	29	16	14	22	46	14x18x17.2	22x29x13.8
KX 80	82-97	DMX09027	68,75	92	18	29	16	14	22	46	14x18x17.2	22x29x13.8
KX 80	98-00	DMX09028	68,75	92	18	29	16	16	22	46	14x18x17.2	22x29x15.8
KX 85	01-16	DMX09028	68,75	92	18	29	16	16	22	46	14x18x17.2	22x29x15.8
KX 100	95-97	DMX09027	68,75	92	18	29	16	14	22	46	14x18x17.2	22x29x13.8
KX 100	98-16	DMX09028	68,75	92	18	29	16	16	22	46	14x18x17.2	22x29x15.8
KX 125	79-87	DMX09029	81,39	106	21	29	17	17,2	22	51	16x21x19.8	22x29x16.8
KX 125	88-91	DMX09031	88,68	109	21	29	17	17	22	51	16x21x19.8	22x29x16.8
KX 125	92-93	DMX09029	81,39	106	21	29	17	17,2	22	51	16x21x19.8	22x29x16.8
KX 125	94-97	DMX09030	86,90	106	19	29	17	17	22	51	15x19x19.8	22x29x16.8
KX 125	98-02	DMX09032	75,59	104	19	29	17	17	22	51	15x19x19.8	22x29x16.8
KX 125	03-06	DMX09035	69,04	104	19	29	17	17	22	56	15x19x19.8	22x29x16.8
KDX 200	86-88	DMX09029	81,39	106	21	29	17	17	22	51	16x21x19.5	22x29x16.8
KDX 200	89-06	DMX09031	88,68	109	21	29	17	17	22	51	16x21x19.8	22x29x16.8
KDX 220	97-06	DMX09031	88,68	109	21	29	17	17	22	51	16x21x19.8	22x29x16.8
KX 250	78-06	DMX09033	82,14	125	22	32	22	19,9	24	59	18x22x23.8	24x32x19.8
KX 250 F	04-09	DMX09050	102,23	92,5	16	38	15	18	30	55		30x38x18
KX 250 F	10-16	DMX09017	89,15	92,5	16	38	15	19	30	56		30x38x18.8
KLX 400	03-04	DAT09165*	105,96	107	20	43	20	22	35	61,85		
KLX 450 R	08-13	DMX09102	124,84	101	19	42	18	19,97	34	60		34x42x19.65
KX 450 F	07-08	DMX09102	124,84	101	19	42	18	19,97	34	60		34x42x19.65
KX 450 F	09-15	DMX09060	161,00	101	19	42	18	19	34	62		
KX 500	85-04	DMX09034	96,12	145	24	33	22	22	26	54	19x24x24.8	26x33x21.9

KTM	BIELA								BULÓN		RODAMIENTO PISTÓN	RODAMIENTO BIELA
	Año	Referencia	€	A	B	C	D	E	Ø	Largo	Medidas	Medidas
65	97-02	DMX09041	79,46	88	15	24	12,9	14,9	18	56	12x15x16.3	18x24x14.8
65	03-08	DMX09039	72,02	88	15	24	12,9	14,9	18	42	12x15x16.3	18x24x14.8
65 SX	09-16	DMX090391	73,64	88	15	24	13	15	18	54,3	12x15x16.3	18x24x14.8
85 SX	03-12	DMX09040	95,68	96	18	28	13	16	22	46	14x18x15.8	22x28x15.8
85 SX	13-16	DMX09105	100,59	96	18	26	14	15	20	46	14x18x16.5	20x26x14.8
105 SX	03-11	DMX09040	95,68	96	18	28	13	16	22	46	14x18x16.5	22x28x15.8
125 EXC	09-15	DMX09059	103,12	110	19	28	16	16	22	55		
125 SX	98-16	DMX09059	103,12	110	19	28	16	16	22	55		
144 SX	07-08	DMX09059	103,12	110	19	28	16	16	22	55		
150 SX	09-15	DMX09059	103,12	110	19	28	16	16	22	55		
150 XC	10-15	DMX09059	103,12	110	19	28	16	16	22	55		
200 EXC	98-16	DMX09037	89,51	118	20	28	16	16	22	55	16X19.7X19.7	
200 SX	03-05	DMX09037	89,51	118	20	28	16	16	22	55	16X19.7X19.7	
200 XC	98-09	DMX09037	89,51	118	20	28	16	16	22	55	16X19.7X19.7	
200 XC-W	98-15	DMX09037	89,51	118	20	28	16	16	22	55	16X19.7X19.7	
250 EXC 2T	90-94	DMX09099	104,61	132	22	30	16,9	16,9	24	60	18X22X19.8	24X30X16.8
250 EXC	04-11	DMX09047	144,48	125	22	30	17	17	24	60	18X22X19.8	24X30X16.8
250 EXC-F	07-13	DMX09038	105,20	98	16	38	17,85	17,85	30	53,5		30X38X17.8
250 EXC-F	14-16	DMX09022	115,04	98	16	30	15	18	30	56		
250 SX 2T	90-99	DMX09099	104,61	132	22	30	16,9	16,9	24	60	18X22X19.8	24X30X16.8
250 SX	03-16	DMX09047	144,48	125	22	30	17	17	24	60	18X22X19.8	24X30X16.8
250 SX-F	05-12	DMX09038	105,20	98	16	38	17,85	17,85	30	53,5		30X38X17.8
250 SX-F	13-15	DMX09022	115,04	98	16	30	15	18	30	56		
250 SXS	03-07	DMX09047	144,48	125	22	30	17	17	24	60	18X22X19.8	24X30X16.8
250 SXS-F	07-08	DMX09038	105,20	98	16	38	17,85	17,85	30	53,5		30X38X17.8
250 XC	04-15	DMX09047	144,48	125	22	30	17	17	24	60	18X22X19.8	24X30X16.8
250 XC-F	07-09	DMX09038	105,20	98	16	38	17,85	17,85	30	53,5		30X38X17.8
250 XC-F	13-15	DMX09022	115,04	98	16	30	15	18	30	56		
250 XC-W	04-14	DMX09047	144,48	125	22	30	17	17	24	60	18X22X19.8	24X30X16.8
250 XCF-W	08-13	DMX09038	105,20	98	16	38	17,85	17,85	30	53,5		30X38X17.8

RUEDAS Y NEUMÁTICOS
MOTOR
ADMISIÓN / ESCAPE REFRIGERACIÓN
ELECTRICO
SUSPENSIÓN / DIRECCIÓN
FRENS
TRANSMISIÓN
CONTROLES Y MANDOS
CHASIS
ACCESORIOS

Bielas completas

Bielas completas con bulón de cigüeñal, separadores y rodamientos.

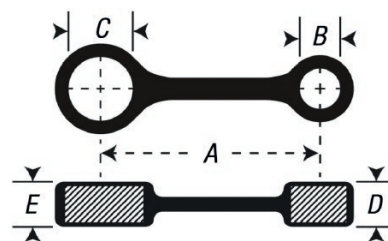

Modelo	Año	Referencia	€	A	B	C	D	E	Ø	Largo	Medidas	Medidas
250 XCF-W	14-16	DMX09022	115,04	98	16	30	15	18	30	56		
300 EXC 2t	90-03	DMX09099	104,61	132	22	30	16,9	16,9	24	60	18x22x19.8	24x30x16.8
300 EXC	04-11	DMX09047	144,48	125	22	30	17	17	24	60	18x22x19.8	24x30x16.8
300 MXC	04-11	DMX09047	144,48	125	22	30	17	17	24	60	18x22x19.8	24x30x16.8
300 XC	04-14	DMX09047	144,48	125	22	30	17	17	24	60	18x22x19.8	24x30x16.8
300 XC-W	04-14	DMX09047	144,48	125	22	30	17	17	24	60	18x22x19.8	24x30x16.8
350 EXC-F	14-16	DMX09023	140,45	102	32	18	17	20	32	60		
350 Freeide	15-17	DMX09023	140,45	102	32	18	17	20	32	60		
350 SX-F	13-15	DMX09023	140,45	102	32	18	17	20	32	60		
350 XC-F	13-15	DMX09023	140,45	102	32	18	17	20	32	60		
350 XCF-W	14-16	DMX09023	140,45	102	32	18	17	20	32	60		
400 EXC	99-06	DMX09024	120,54	129	20	43	21,9	21,9	35	64,7		35 X 43 X 21.7
400 EXC-G	99-06	DMX09024	120,54	129	20	43	21,9	21,9	35	64,7		35 X 43 X 21.7
400 LC4	97-07	DMX09015	179,01	141,5	22	50	22,9	22,9	40	65	40X40X22.7	
400 SX	00-02	DMX09024	120,54	129	20	43	21,9	21,9	35	64,7		35 X 43 X 21.7
400 XC-W	2007	DMX09024	120,54	129	20	43	21,9	21,9	35	64,7		35 X 43 X 21.7
450 EXC	03-07	DMX09024	120,54	129	20	43	21,9	21,9	35	64,7		35 X 43 X 21.7
520 EXC	00-02	DMX09024	120,54	129	20	43	21,9	21,9	35	64,7		35 X 43 X 21.7
520 SX	00-02	DMX09024	120,54	129	20	43	21,9	21,9	35	64,7		35 X 43 X 21.7
525 EXC	03-07	DMX09024	120,54	129	20	43	21,9	21,9	35	64,7		35 X 43 X 21.7
525 SM-R	04-05	DMX09024	120,54	129	20	43	21,9	21,9	35	64,7		35 X 43 X 21.7
525 SX	03-07	DMX09024	120,54	129	20	43	21,9	21,9	35	64,7		35 X 43 X 21.7
600 LC4	97-07	DMX09015	179,01	141,5	22	50	22,9	22,9	40	65	40X40X22.7	

BIELA													BULÓN	RODAMIENTO PISTÓN	RODAMIENTO BIELA
SUZUKI	Año	Referencia	€	A	B	C	D	E	Ø	Largo	Medidas	Medidas			
RM 60	2003	DMX09026	68,75	85	16	27	14	14	20	46	12x16x15	20x27x13.8			
RM 65	03-05	DMX09026	68,75	85	16	27	14	14	20	46	12x16x15	20x27x13.8			
RM 85	02-16	DMX09055	68,75	93,5	18	26	14	14	20	45	14x18x15.8	20x26x13.8			
RM 100	03-05	DMX09028	68,75	92	18	29	16	16	22	46	14x18x17.2	22x29x15.8			
RM 125	88-96	DMX09052	81,39	105	19	28	18	16	22	53	15x19x19.8	22x28x15.8			
RM 125	99-03	DMX09057	85,41	102	19	28	18	16	22	53	15x19x19.8	22x28x15.8			
RM 125	04-09	DMX090591	82,46	110	19	28	16	16	22	52,7	15x19x19.8	22x28x15.8			
RM 250	87-95	DMX09053	83,48	128	23	30	20	20	24	58	18x23x22	24x30x19.8			
RM 250	96-02	DMX09054	99,55	125,5	23	30	20	20	24	58	18x23x22	24x30x19.8			
RM 250	03-08	DMX09058	99,55	125	23	32	20	20	24	58	18x23x22	24x30x19.8			
RMX 250	93-99	DMX09053	83,48	128	23	30	20	20	24	58	18x23x22	24x30x19.8			
RMZ 250	07-16	DMX09050	102,23	92,5	16	38	15	18	30	55		30x38x18			
DRZ 400	00-15	DAT09165	105,96	107	20	43	20	22	35	61,85					
DRZ 400 SM	00-15	DAT09165	105,96	107	20	43	20	22	35	61,85					
RMZ 450	05-16	DMX09016	119,39	106	19	42	18,5	20	34	61		34x42x19.8			

BIELA													BULÓN	RODAMIENTO PISTÓN	RODAMIENTO BIELA
YAMAHA	Año	Referencia	€	A	B	C	D	E	Ø	Largo	Medidas	Medidas			
YZ 80	93-01	DMX09076	61,31	96	18	26	14	14	20	44	14x18x15.8	20x26x13.8			
YZ 85	02-15	DMX09076	61,31	96	18	26	14	14	20	44	14x18x15.8	20x26x13.8			
YZ 125	86-96	DMX09077	77,24	105	20	29	17	17	22	55	16x20x19.5	22x29x16.8			
YZ 125	97-00	DMX09078	78,75	105	20	29	17	17	22	55	15x20x17.7	22x29x16.8			
YZ 125	01-04	DMX09082	85,65	105	19	29	16	17	22	55	15x19x16.8	22x29x16.8			
YZ 125	05-14	DMX09084	73,51	102	19	29	16	17	22	54	15x19x17	22x29x16			
YZ 250	90-98	DMX09080	92,85	125	23	32	20	20	25	60	18x23x22	25x32x19.8			
YZ 250	99-14	DMX09083	81,54	125	22	31	20	17	24	59	18x23x22	24x31x16.8			
WR 250	90-98	DMX09080	92,85	125	23	32	20	20	25	60	18x23x22	25x32x19.8			
YZ 250 F	03-13	DMX09085	122,16	93,5	16	40	15	18	32	55		32x40x20			
WR 250 F	03-13	DMX09085	122,16	93,5	16	40	15	18	32	55		32x40x20			
YZ 400	1998	DMX09081	120,30	102	18	42	18	20	34	60,8		34x42x19.8			
YZ 450 F	03-05	DMX09086	109,22	103,5	18	42	18	20	34	61		34x42x20			
YZ 450 F	06-09	DMX09087	107,73	103,5	18	42	18	20	34	61		34x42x20			
YZ 450 F	10-17	DMX09090	128,71	103	18	42	18	21	34	61		34x22x20.8			
WR 450 F	04-05	DMX09086	109,22	103,5	18	42	18	20	34	61		34x42x20			
WR 450 F	07-11	DMX09087	107,73	103,5	18	42	18	20	34	61		34x42x20			
XT 500	Todas	DMX09044	169,48	145	20	42	24	24	34	73,8		35x43x21.8			
XT 600 E	86-95	DMX09043	162,79	135,5	22	43	22	22	35	74		34x42x23.5			

PSYCHIC MX COMPONENTS Kit retenes motor

El kit consta de todo el material necesario para sustituir los retenes del motor.

HONDA	Año	Referencia	€
CR 125	05-07	DMX09277	14,73
CRF 150 R	07-16	DMX09272	19,25
CR 250 R	02-04	DMX09261	13,68
CRF 250 R	04-09	DMX09279	23,20
CRF 250 R	10-16	DMX09273	24,12
CRF 250 X	04-13	DMX09279	23,20
CRF 450 R	07-08	DMX09284	21,15
CRF 450 R	09-16	DMX09285	21,62
CRF 450 X	05-08	DMX09274	21,38

HUSABERG	Año	Referencia	€
TE 250	11-14	DMX09295	16,51
TE 300	11-14	DMX09295	16,51

HUSQVARNA	Año	Referencia	€
TC 85	14-15	DMX09294	13,90
TC 125	14-15	DMX09226	15,23
TE 125	2015	DMX09226	15,23
TC 250	14-15	DMX09295	16,51
TE 250	14-15	DMX09295	16,51
TE 300	14-15	DMX09295	16,51

KAWASAKI	Año	Referencia	€
KX 250	05-08	DMX09289	14,02
KX 250 F	06-13	DMX09378	12,71
KX 450 F	06-13	DMX09379	12,47

KTM	Año	Referencia	€
65 SX	09-16	DMX09290	18,65
65 XC	09-16	DMX09290	18,65
85 SX	03-15	DMX09294	13,90
85 XC	03-13	DMX09294	13,90
105 SX	03-13	DMX09294	13,90
105 XC	03-13	DMX09294	13,90
125 EXC	98-06	DMX09226	15,23

125 SX	98-14	DMX09226	15,23
144 SX	07-08	DMX09226	15,23
150 SX	09-14	DMX09226	15,23
150 XC	10-14	DMX09226	15,23
200 EXC	98-05	DMX09226	15,23
200 SX	00-04	DMX09226	15,23
200 XC	06-09	DMX09226	15,23
200 XC-W	06-14	DMX09226	15,23
250 SX	03-16	DMX09295	16,51
250 XC	06-16	DMX09295	16,51
250 XC-W	06-16	DMX09295	16,51
250 SX-F	05-06	DMX09296	16,75
250 XC-F	05-06	DMX09296	16,75
250 SXS-F	05-11	DMX09296	16,75
300 XC	06-16	DMX09295	16,51
300 XC-W	06-16	DMX09295	16,51
350 SX-F	11-12	DMX09291	29,34
350 XC-F	11-12	DMX09291	29,34
400 SX	00-02	DMX09292	14,02
400 MXC	00-02	DMX09292	14,02
400 EXC	00-02	DMX09292	14,02
400 SX	00-02	DMX09292	14,02
400 EXC	04-06	DMX09292	14,02
450 EXC	03-07	DMX09292	14,02
450 MXC	03-05	DMX09292	14,02
450 SX	03-06	DMX09292	14,02
450 SXS-F	07-12	DMX09293	30,29
450 SX-F	07-12	DMX09293	30,29
450 XC-F	08-09	DMX09293	30,29
500 SX	08-09	DMX09293	30,29
500 SX-F	08-09	DMX09293	30,29
500 XC-F	08-09	DMX09293	30,29
505 SX	08-09	DMX09293	30,29
505 SX-F	08-09	DMX09293	30,29
505 XC-F	08-09	DMX09293	30,29



520 SX	00-02	DMX09292	14,02
520 MXC	00-02	DMX09292	14,02
520 EXC	00-02	DMX09292	14,02
525 SX	03-07	DMX09292	14,02
525 MXC	03-07	DMX09292	14,02
525 EXC	03-07	DMX09292	14,02

SUZUKI	Año	Referencia	€
RM 125	01-03	DMX09269	17,34
RM 125	04-08	DMX09268	17,50
RM 250	03-05	DMX09265	16,75
RMZ 250	04-06	DMX09372	12,47
RMZ 250	07-09	DMX09363	18,65
RMZ 250	10-12	DMX09364	20,08
RMZ 450	05-07	DMX09366	22,81
RMZ 450	08-15	DMX09365	21,86

YAMAHA	Año	Referencia	€
YZ 125	05-15	DMX09271	14,85
WR 250 F	01-09	DMX09267	10,81
YZ 250	99-08	DMX09220	19,48
YZ 250 F	01-13	DMX09267	10,81
WR 450 F	03-14	DMX09298	10,81
YZ 450 F	03-13	DMX09298	10,81



PSYCHIC MX COMPONENTS Cigüeñales completos

Cigüeñal y biela montado, listo para ser sustituido. Incluye el rodamiento de biela-pistón.

HONDA	Año	Referencia	€
CR 80 R	86-02	DMX09115	152,35
CR 85 R	03-04	DMX09115	152,35
CRF 250 R	04-09	DMX09138	211,78
CRF 250 R	10-15	DMX09135	216,45

KAWASAKI	Año	Referencia	€
KX 80	91-00	DMX09119	152,35
KX 85	01-05	DMX09119	152,35
KX 100	95-05	DMX09119	152,35
KX 125	03-05	DMX09118	165,64

KTM	Año	Referencia	€
85 SX	03-12	DMX09137	148,65
105 SX	04-11	DMX09137	148,65
250 XCF-W	12-13	DMX09136	195,30
250 SX-F	05-10	DMX09139	205,49
250 SX-F	11-12	DMX09136	195,30
250 XC-F	11-12	DMX09136	195,30

SUZUKI	Año	Referencia	€
RM 100	2003	DMX09119	152,35
RM 125	04-07	DMX09131	190,00

YAMAHA	Año	Referencia	€
YZ 125	05-17	DMX09133	181,24
YZ 250	03-17	DMX09140	



Kit discos embrague

El Kit de Embrague reforzado consta de los discos de fricción más los discos metálicos o de separación y los muelles. La calidad es superior a los discos originales, en algunos casos puede ser como mínimo igual al original.



HONDA	Año	Referencia	€
CR 80 R	87-02	DMX03500H	27,32
CR 80 RB	87-02	DMX03500H	27,32
CR 85 R	03-07	DMX03500H	27,32
CRF 100 F	04-16	DMX03576H	23,09
XR 100 R	87-03	DMX03576H	23,09
CR 125 R	86-99	DMX03501H	46,30
CR 125 R	00-07	DMX03547H	52,11
CRF 150 R	07-16	DMX03205H	37,60
CRF 150 RB	07-16	DMX03205H	37,60
XR 200 R	86-02	DMX03578H	27,57
CRF 230 F	03-16	DMX03580H	38,08
CR 250 R	83-89	DMX03502H	53,68
CR 250 R	90-93	DMX03543H	60,45
CR 250 R	94-07	DMX03552H	68,87
CRF 250 L	13-14	DMX03704H	38,93
CRF 250 R	04-07	DMX03602H	54,15
CRF 250 R	08-09	DMX03231H	56,44
CRF 250 R	11-16	DMX03631H	58,23
CRF 250 RA	2010	DMX03610H	47,13
CRF 250 RB	11-13	DMX03231H	56,44
CRF 250 X	04-13	DMX03231H	56,44
CRF 250 L	13-14	DMX03704H	38,93
XR 250 R	86-95	DAT03903	37,07
XR 250 R	96-04	DMX03583H	38,45
XR 250 L	91-96	DAT03903	37,07
XR 400 R	1996	DMX03584H	46,79
XR 400 R	97-04	DMX03585H	44,49
CRF 450 R	02-03	DMX03551H	67,87
CRF 450 R (6 muelles)	04-05	DMX03574H	66,44
CRF 450 R (6 muelles)	06-08	DMX03551H	67,87
CRF 450 R (4 muelles)	09-10	DMX03611H	60,81
CRF 450 R	11-12	DMX03632H	60,57
CRF 450 R	13-16	DMX03664H	63,11
CRF 450 R (6 muelles)	06-08	DMX03551H	67,87
CRF 450 R (4 muelles)	09-10	DMX03611H	60,81
CRF 450 X	05-16	DMX03574H	61,30
CR 500 R	84-89	DMX03502H	53,68
CR 500 R	90-02	DMX03543H	60,45
XR 600 R	85-00	DMX03588H	51,14
NX 650	88-89	DMX03588H	51,14
XR 650 L	93-16	DMX03588H	51,14

KAWASAKI	Año	Referencia	€
KX 60	85-03	DMX03503H	25,87
KX 65	00-16	DMX03546H	26,24
KX 80	89-97	DMX03506H	34,70
KX 80	98-00	DMX03528H	35,91
KX 85	01-16	DMX03528H	35,91
KX 100	95-97	DMX03506H	34,70
KX 100	98-16	DMX03528H	35,91
KX 125	94-02	DMX03541H	54,36
KX 125	03-05	DMX03564H	53,32
KLX 250 S	06-14	DMX03614H	48,24
KX 250	92-07	DMX03529H	66,88
KX 250 F	04-16	DMX03601H	60,88
KLX 300 R	98-07	DMX03614H	48,24
KLX 400 R	03-04	DAT03915H	61,63
KLX 450 R	08-12	DMX03200H	60,69
KX 450 F	06-11	DMX03200H	60,69
KX 450 F	12-16	DMX03634H	63,11

KTM	Año	Referencia	€
60 SX	98-00	DMX03549H	33,49
65 SX	98-08	DMX03549H	33,49
65 SX	09-16	DMX03233H	33,49
65 XC	2008	DMX03549H	33,49
65 XC	09-10	DMX03233H	33,49
85 SX (17"/14")	03-16	DMX03210H	37,00
85 SX (19"/16")	03-16	DMX03210H	37,00
85 XC	08-09	DMX03210H	37,00
105 SX	04-10	DMX03210H	37,00
105 XC	08-10	DMX03210H	37,00
125 EGS	98-99	DMX03605H	48,99
125 EXC	98-05	DMX03605H	48,99
125 EXE	00-01	DMX03605H	48,99
125 Supermoto	00-01	DMX03605H	48,99
125 SX	98-07	DMX03605H	48,99
125 SX	2008	DMX03234H	49,33
125 SX	09-16	DMX03605H	48,99
125 SXS	01-02	DMX03605H	48,99
150 SX	08-16	DMX03230H	48,72
150 XC	10-14	DMX03230H	48,72
200 EGS	98-99	DMX03230H	48,72
200 EXC	97-05	DMX03230H	48,72
200 SX	2003	DMX03230H	48,72
200 XC-W	07-16	DMX03230H	48,72
200 XC	06-09	DMX03230H	48,72
250 SX	94-11	DMX03550H	70,73
250 EGS	94-99	DMX03550H	70,73
250 EXC	94-05	DMX03550H	70,73
250 EXC Racing	02-03	DMX03208H	94,30
250 EXC Racing	2004	DMX03235H	76,89
250 EXC Racing	2005	DMX03239H	93,21
250 EXG-G Racing	2003	DMX03208H	98,80
250 EXC-G Racing	2004	DMX03235H	76,89
250 SX	94-12	DMX03550H	70,73
250 SX-F	05-12	DMX03207H	51,14
250 SX-F	13-16	DMX03630H	109,54
250 XC-F	06-09	DMX03207H	51,14
250 XC-F	13-15	DMX03630H	109,54
250 XC-F-W	06-13	DMX03207H	51,14
250 XC-F-W	14-16	DMX03705H1	103,63
250 XC-W	06-12	DMX03550H	70,73
250 XC-W	13-14	DMX03706H1	103,63
250 XC-F-W Six Days	2011	DMX03207H	51,14
250 XC	06-12	DMX03550H	70,73
250 XC	13-15	DMX03706H1	103,63
250 SXS	01-03	DMX03550H	70,73
300 E-GS	94-99	DMX03550H	70,73
300 EXC	94-05	DMX03550H	70,73
300 SX	1994	DMX03550H	70,73
300 Six Days	1996	DMX03550H	70,73
300 XC	06-12	DMX03550H	70,73
300 XC	13-14	DMX03706H	62,14
300 XC-W	06-11	DMX03550H	70,73
350 EXC-F	12-15	DMX03705H	46,30
350 SX-F	11-13	DMX03630H	109,54
350 XC-F	11-15	DMX03630H	109,54
350 XC-F-W	12-16	DMX03705H1	103,63
360 EGS	96-97	DMX03550H	70,73
360 EXC	96-97	DMX03550H	70,73
360 SX	96-97	DMX03550H	70,73
360 Six Days	1996	DMX03550H	70,73
380 EXC	98-02	DMX03550H	70,73
380 SX	98-02	DMX03550H	70,73

400 EXC	00-01	DMX03235H	76,89
400 EXC	2007	DMX03208H	98,80
400 EXC	2002	DMX03208H	98,80
400 EXC Racing	2005	DMX03239H	93,21
400 EXC-G Racing	2002	DMX03208H	98,80
400 EXC-G Racing	2005	DMX03239H	93,21
400 EXC-G Racing	2006	DMX03208H	98,80
400 SX	00-01	DMX03235H	76,89
400 SX Racing	2002	DMX03208H	98,80
400 XC-W	10-11	DMX03628H	75,44
450 EXC	07-09	DMX03208H	98,80
450 EXC Racing	10-11	DMX03628H	75,44
450 EXC Racing	2003	DMX03208H	98,80
450 EXC-G Racing	2003	DMX03208H	98,80
450 EXC Racing	2004	DMX03235H	76,89
450 EXC Racing	2005	DMX03239H	93,21
450 EXC-G Racing	2004	DMX03235H	76,89
450 LXC-G Racing	2005	DMX03239H	93,21
450 SMR	04-05	DMX03239H	93,21
450 SMR	2006	DMX03208H	98,80
450 SX	2006	DMX03208H	98,80
450 SX-F	07-10	DMX03209H	73,14
450 SX-F	2012	DMX03705H1	103,63
450 SX-F	2013	DMX03706H1	103,63
450 SX-F	14-15	DMX03709H1	103,63
450 SX Racing	2003	DMX03208H	98,80
450 SX Racing	2004	DMX03235H	76,89
450 SX Racing	2005	DMX03239H	93,21
450 EXC-R	2008	DMX03628H	75,44
450 XCR-W	2008	DMX03628H	75,44
450 XC-W	08-09	DMX03209H	73,14
450 XC-W Six Days	10-11	DMX03628H	75,44
450 XC-W	2012	DMX03705H	46,30
450 XC-W	2014	DMX03709H1	103,63
450 XC-F	08-09	DMX03209H	73,14
450 XC-F	2013	DMX03706H1	103,63
450 XC-F	14-15	DMX03709H1	103,63
450 XC-W	2012	DMX03705H1	103,63
500 EXC	2012	DMX03705H1	103,63
500 XC-W	13-14	DMX03706H1	103,63
505 SX-F	07-09	DMX03209H	73,14
505 XC-F	08-09	DMX03209H	73,14
520 EXC	00-01	DMX03235H	76,89
520 SX Racing	00-01	DMX03235H	76,89
520 SX Racing	2002	DMX03208H	98,80
525 EXC-G Racing	2003	DMX03208H	98,80
525 EXC	2003	DMX03208H	98,80
525 EXC Racing	2004	DMX03235H	76,89
525 EXC Racing	2005	DMX03239H	93,21
525 EXC-G Racing	2004	DMX03235H	76,89
525 EXC-G Racing	2005	DMX03239H	93,21
525 SMR	04-05	DMX03239H	93,21
525 SX Racing	2006	DMX03208H	94,30
525 SX Racing	2003	DMX03208H	98,80
525 SX Racing	2004	DMX03235H	76,89
525 SX Racing	2005	DMX03239H	93,21
530 EXC	10-11	DMX03628H	75,44
530 EXC Champ. Edi.	2010	DMX03628H	75,44
530 XC-W Six Days	10-11	DMX03628H	75,44
540 SXC	98-99	DMX03625H	71,33
540 SXS Racing	2002	DMX03208H	98,80
560 SMR	2006	DMX03208H	98,80
620 LC4 Competition	1999	DMX03625H	71,33
620 LC4 Super Moto	1999	DMX03625H	71,33
620 Super Comp	96-99	DMX03625H	71,33
620 SX	97-99	DMX03625H	71,33
620 SX	1999	DMX03625H	71,33
620 SC	00-01	DMX03625H	71,33
620 Supermoto	1998	DMX03625H	71,33
620 TXC	1998	DMX03625H	71,33
625 SMC	04-06	DMX03625H	71,33
625 SC	2002	DMX03625H	71,33
625 SXC	03-04	DMX03625H	71,33
640 Adventure-R	98-02	DMX03625H	71,33

640 LC4	99-00	DMX03625H	71,33
640 LC4-E	00-02	DMX03625H	71,33
640 LC4 Adventure	03-06	DMX03625H	71,33
640 LC4 Supermoto	03-04	DMX03625H	71,33
640 LC4 Six Days	1999	DMX03625H	71,33
660 LC4 Rallye	99-00	DMX03625H	71,33
690 Enduro	2008	DMX03627H	70,85
690 Enduro R	10-14	DMX03627H	70,85
690 Supermoto	07-08	DMX03627H	70,85
690 SMC	08-11	DMX03627H	70,85

SUZUKI

	Año	Referencia	€
RM 60	2003	DMX03503H	25,87
RM 65	03-05	DMX03546H	26,24
RM 80	91-01	DMX03516H	30,71
RM 85	02-12	DMX03516H	30,71
RM 85	15-16	DMX03516H	30,71
RM 100	03-04	DMX03546H	26,24
DR-Z 110	03-05	DMX03546H	26,24
RM 125	93-98	DMX03565H	53,32
RM 125	99-01	DMX03572H	59,16
RM 125	02-08	DMX03604H	63,48
RM 250	88-90	DMX03526H	62,51
RM 250	91-93	DMX03530H	64,44
RM 250	94-95	DMX03540H	62,51
RM 250	1996	DMX03553H	66,37
RM 250	97-02	DMX03554H	71,34
RM 250	03-05	DMX03711H	54,28
RM 250	06-08	DMX03237H	78,81
RMX 250	94-00	DMX03540H	62,51
RM-Z 250	04-06	DMX03601H	57,31
RM-Z 250	07-09	DMX03206H	62,14
RM-Z 250	10-16	DMX03620H	59,72
DR 350	90-99	DMX03593H	54,16
DR-Z 400 E	00-16	DAT03915H	65,37
RMX 450	10-11	DMX03575H	70,36
RM-Z 450	05-16	DMX03575H	70,36

YAMAHA

	Año	Referencia	€
YZ 80	86-92	DMX03517H	31,55
YZ 80	93-94	DMX03534H	31,55
YZ 80	95-01	DMX03555H	37,12
YZ 85	02-14	DMX03573H	38,57
TTR 125	00-14	DMX03619H	26,11
YZ 125	91-92	DMX03525H	46,06
YZ 125	1996	DMX03556H	58,84
YZ 125	97-01	DMX03538H	51,99
YZ 125	02-04	DMX03556H	58,84
YZ 125	05-14	DMX03539H	51,99
WR 200 D	1992	DAT03901H	38,41
WR 250	2001	DMX03568H	55,73
WR 250 F	02-13	DMX03570H	59,85
WR 250 R	08-15	DMX03525H	46,06
WR 250 X	08-15	DMX03525H	46,06
YZ 250	85-87	DMX03523H	51,87
YZ 250	88-92	DMX03521H	57,43
YZ 250	93-99	DMX03539H	64,92
YZ 250	00-01	DMX03544H	68,32
YZ 250	02-16	DMX03567H	65,65
YZ 250 F	01-07	DMX03568H	55,73
YZ 250 F	08-13	DMX03229H	62,12
WR 400 F	98-00	DMX03545H	56,22
YZ 400 F	98-99	DMX03545H	56,22
YZ 426 F	2000	DMX03548H	68,31
YZ 426 F	01-02	DMX03569H	74,40
WR 426 F	01-02	DMX03603H	69,15
WR 450 F	03-04	DMX03603H	69,15
WR 450 F	05-14	DMX03218H	67,82
YZ 450 F	03-04	DMX03557H	69,03
YZ 450 F	05-06	DMX03201H	67,70
YZ 450 F	07-13	DMX03217H	65,89
YZ 450 F	14-16	DMX03726H	67,01
YZ 490	82-89	DMX03522H	51,14
XT 600	90-95	DAT03904H	59,66

Juntas de embrague

* Junta interior

** Junta exterior

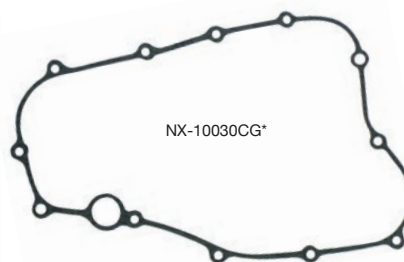
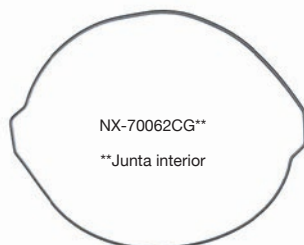
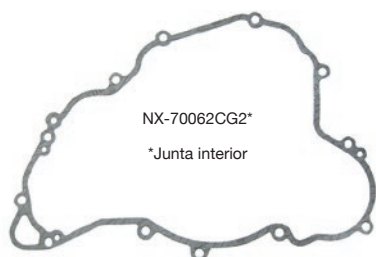

HONDA	Año	Referencia	Referencia Original	€
CRF 50 F	04-16	NX10070CG	11394-035-010 11394-GW8-681	5,85
XR 50 R	00-03	NX10070CG	11394-035-010 11394-GW8-681	5,85
XR 70 R	97-03	NX10070CG	11394-035-010 11394-GW8-681	5,85
CRF 70 F	04-12	NX10070CG	11394-035-010 11394-GW8-681	5,85
CRF150 F	06-16	NX10151CG	11393-KRM-840 11393-KWK-900	10,11
CRF 250 R	04-09	NX10030CG*	11394-KRN-A01	15,37
CRF 250 R	04-09	NX10030CG2**	11352-KRN-671	5,01
CRF 250 R	10-17	NX10031CG2*	11394-KRN-A40	10,67
CRF 250 R	10-17	NX10031CG**	11352-KRN-A41	5,94
CRF 250 X	04-16	NX10030CG*	11394-KRN-A01	15,37
CRF 250 X	04-16	NX10030CG2**	11352-KRN-671	5,01
XR 400 R	96-04	NA10003CG*	11394-KCY-670 11394-KCY-671	11,88
CRF 450 R	02-08	NX10045CG2*	11394-MEB-670	11,76
CRF 450 R	02-08	NX10045CG**	11352-MEB-671	5,01
CRF 450 R	09-16	NX10048CG*	11394-MEN-A40	11,76
CRF 450 R	09-16	NX10045CG**	11352-MEB-671	5,01
CRF 450 X	05-17	NX10045CG**	11352-MEB-671	5,01

HUSABERG	Año	Referencia	Referencia Original	€
FE 350	13-15	NX70062CG2*	77230025000	11,79
FE 350	13-15	NX70062CG**	77230027000	6,36

HUSQVARNA	Año	Referencia	Referencia Original	€
FC 250	14-15	NX70062CG2*	77230025000	11,79
FC 250	14-15	NX70062CG**	77230027000	6,36
FE 250	14-16	NX70062CG2*	77230025000	11,79
FE 250	14-16	NX70062CG**	77230027000	6,36
FE 350	14-16	NX70062CG2*	77230025000	11,79
FE 350	14-16	NX70062CG**	77230027000	6,36
FE 350S	15-16	NX70062CG2*	77230025000	11,79
FE 350S	15-16	NX70062CG**	77230027000	6,36
FC 350	14-15	NX70062CG2*	77230025000	11,79
FC 350	14-15	NX70062CG**	77230027000	6,36

KAWASAKI	Año	Referencia	Referencia Original	€
KLR650	87-17	NX20019CG	11060-1111 11061-0429	13,61

KTM	Año	Referencia	Referencia Original	€
250 SX-F	13-15	NX70062CG2*	77230025000	11,79
250 SX-F	13-15	NX70062CG**	77230027000	6,36
250 XC-F	13-15	NX70062CG2*	77230025000	11,79
250 XC-F	13-15	NX70062CG**	77230027000	6,36
250 XCF-W	14-15	NX70062CG2*	77230025000	11,79
250 XCF-W	14-15	NX70062CG**	77230027000	6,36
250 XCF-W	2016	NX70062CG2*	77230025000	11,79
250 XCF-W	2016	NX70062CG**	77230027000	6,36
350 SX-F	11-12	NX70062CG2*	77230025000	11,79
350 SX-F	11-12	NX70062CG**	77230027000	6,36
350 SX-F	13-15	NX70062CG2*	77230025000	11,79
350 SX-F	13-15	NX70062CG**	77230027000	6,36
350 XC-F	11-12	NX70062CG2*	77230025000	11,79
350 XC-F	11-12	NX70062CG**	77230027000	6,36
350 XC-F	13-15	NX70062CG2*	77230025000	11,79
350 XC-F	13-15	NX70062CG**	77230027000	6,36
350 EXC-F	12-16	NX70062CG2*	77230025000	11,79
350 EXC-F	12-16	NX70062CG**	77230027000	6,36
350 XCF-W	12-16	NX70062CG2*	77230025000	11,79
350 XCF-W	12-16	NX70062CG**	77230027000	6,36
350 Freeride	13-14	NX70062CG2*	77230025000	11,79
350 Freeride	13-14	NX70062CG**	77230027000	6,36

SUZUKI	Año	Referencia	Referencia Original	€
DR 350 Manual	90-99	NX30044CG	11482-14D00 11482-14D03	11,65

YAMAHA	Año	Referencia	Referencia Original	€
XT 125	82-83	NX40020CG	4BE-15462-00	11,28
XT 200	82-83	NX40020CG	4BE-15462-00	11,28
BW 200 Rueda alta	85-88	NX40020CG	4BE-15462-00	11,28
TW 200	87-16	NX40020CG	4BE-15462-00	11,28
TT 225	86-87	NX40020CG	4BE-15462-00	11,28
TT 225	2001	NX40020CG	4BE-15462-00	11,28
XT 225	98-07		4BE-15451-00-00	
TTR 225	99-04	NX40022CG	4BE-15451-01-00	7,53
TTR 230	05-16		4BE-15451-02-00 4BE-15451-03-00	
YZ 450 F	03-05	NX40045CG*	5TA-15462-00-00 5TG-15462-02-00	11,21
YZ 450 F	10-13	NX40047CG*	33D-15462-00-00	9,98
YZ 450 F	10-17	NX40047CG2**	33D-15453-00-00	6,64
YZ 450 F	14-17	NX40048CG*	1SL-15462-00-00	11,76
WR 450 F	03-06	NX40045CG*	5TA-15462-00-00 5TG-15462-02-00	11,21
WR 450 F	16-17	NX40048CG*	1SL-15462-00-00	11,76



Protectores tapa de embrague

€
20,58

HONDA	Año	Referencia
CRF 250 R	10-16	DMX03461
CRF 450 R	09-16	DMX03462

KAWASAKI	Año	Referencia
KX 250 F	09-16	DMX03465
KX 450 F	06-15	DMX03466
KX 450 F	2016	DMX03467

KTM	Año	Referencia
250 EXC-F	14-16	DMX03470
250 XCF-W	14-16	DMX03470
250 SX-F	13-15	DMX03470
250 SX-F	2016	DMX03472
250 XC-F	13-15	DMX03470
250 XC-F	2016	DMX03472
350 EXC-F	12-16	DMX03470
350 SX-F	11-15	DMX03470
350 SX-F	2016	DMX03472
350 XC-F	11-15	DMX03470
350 XC-F	2016	DMX03472
350 XCF-W	12-16	DMX03470
450 EXC	12-16	DMX03471
450 SX-F	13-15	DMX03471
450 SX-F	2016	DMX03473
450 XC-F	13-15	DMX03471
450 XC-F	2016	DMX03473
450 XC-W	12-16	DMX03471
500 EXC	12-16	DMX03471
500 XC-W	12-16	DMX03471



DMX03461



DMX03462



DMX03465



DMX03466



DMX03472



DMX03473



DMX03468



DMX03469

SUZUKI	Año	Referencia
RM-Z 250	07-16	DMX03468
RM-Z 450	11-16	DMX03469

YAMAHA	Año	Referencia
WR 250 F	15-16	DMX03464
WR 450 F	2016	DMX03463
YZ 250 F	14-16	DMX03464
YZ 450 F	14-16	DMX03463



DMX03463



DMX03464

Extractor de bulón

Referencia	€
X09610	16,68



Compresor de válvulas

Referencia	€
DUP121911	42,15



Montador de válvulas

Referencia	Descripción	€
DMX12971	Válvula 5mm	14,80
DMX129711	Válvula 5,5mm	14,80



Útil zapatas embrague KTM

Referencia	€
DMX12154	9,00



Ajustador válvula escape 2t KTM

Referencia	€
DMX12153	11,20



Alicates plato embrague

Referencia	€
DUP12212	23,72



RUEDAS Y NEUMÁTICOS

MOTOR

ADMISIÓN / ESCAPE
REFRIGERACIÓN

ELECTRICO

SUSPENSIÓN / DIRECCIÓN

FRENOS

TRANSMISIÓN

CONTROLES Y MANDOS

CHASIS

ACCESORIOS

EMGO
PSYCHIC

Filtros de aceite

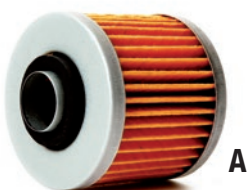

Tipo	Equivalencia Hiflo Filtro	Ref. EMGO	Ref. BRONCO	€
A		E10-55510		3,27
A	HF112	E10-99200		3,27
A	HF116	E10-99210		3,82
A	HF123	E10-30000		3,27
A	HF132	E10-55500		3,27
A	HF136	E10-99300		3,27
A	HF140		DAT07132	3,27
A	HF142	E10-79120		3,27
A	HF154		DMX07170	3,27
A	HF157		DMX07013	3,82
A	HF164		DMC07217	6,3
A	HF207		DMX07157	3,27
A	HF563		DMX07171	3,82
A	HF611		DMX07019	3,82
A	HF631		DMX07172	3,82
A	HF650		DMX07168	3,82
A	HF651		DMX07169	3,27
A	HF652		DMX07011	3,27
A	HF655		DMX07010	3,82

APRILIA	Año	Referencia	Hiflo filtro	€
450 RXV Enduro	06-15	DMX07171	HF563	3,82
550 RXV Enduro	06-14	DMX07171	HF563	3,82

BETA	Año	Referencia	Hiflo filtro	€
125 Alp 4T	00-05	E10-55500	HF132	3,27
125 RR Enduro / Motard	10-16	DAT07132	HF141	3,27
200 Alp 4T	00-15	E10-55500	HF132	3,27
250 Evo 4T	09-16	DMX07157	HF207	3,27
250 Rev 4T	07-08	DMX07157	HF207	3,27
250 RR Enduro 4T	05-09	DMX07010**	HF155	3,82
		DMX07013*	HF157	3,82
300 Evo 4T	09-16	DMX07157	HF207	3,27
350 Alp 4.0	03-15	E10-99300	HF136	3,27
350 M4 4T	06-16	E10-99300	HF136	3,27
350 RR Enduro 4T	11-16	DMX07172	HF631	3,82
390 RR Enduro 4T	15-16	DMX07172	HF631	3,82
400 RR Enduro 4T	05-09	DMX07010**	HF155	3,82
		DMX07013*	HF157	3,82
400 RR Enduro 4T	10-15	DMX07172	HF631	3,82
430 RR Enduro 4T	15-16	DMX07172	HF631	3,82
450 RR Enduro 4T	05-09	DMX07010**	HF155	3,82
		DMX07013*	HF157	3,82
450 RR Enduro 4T	10-15	DMX07172	HF631	3,82
480 RR Enduro 4T	15-16	DMX07172	HF631	3,82
498 RR Enduro 4T	12-16	DMX07172	HF631	3,82
520 RR Enduro 4T	10-14	DMX07172	HF631	3,82
525 RR Enduro 4T	05-09	DMX07010**	HF155	3,82
		DMX07013*	HF157	3,82

BMW	Año	Referencia	Hiflo filtro	€
R 1200	05-13	DMC07217	HF164	6,3

DERBI	Año	Referencia	Hiflo filtro	€
125 Senda R DRD Racing 4T	09-13	DMX07171	HF563	3,82
125 Terra 4T	07-13	DMX07171	HF563	3,82

GAS GAS	Año	Referencia	Hiflo filtro	€
250 EC F 4t	10-11	DAT07132	HF141	3,27
250 EC F 4t	12-15	DAT07132	HF140	3,27
300 EC F 4t	13-15	DAT07132	HF140	3,27
400 FSE	03-07	E10-99200	HF112	3,27
450 EC	08	E10-99200	HF112	3,27
450 FSR	08	E10-99200	HF112	3,27
450 Pampera	07-08	E10-99200	HF112	3,27
450 EC F 4t	13-15	DAT07132	HF140	3,27
510 EC	09	E10-99200	HF112	3,27

HONDA	Año	Referencia	Hiflo filtro	€
CRF 150 R	07-16	E10-99210	HF116	3,82
CRF 150 RB	07-16	E10-99210	HF116	3,82
CRF 250 L	13-16	E10-99200	HF112	3,27
CRF 250 M	14-15	E10-99200	HF112	3,27
CRF 250 R	04-16	E10-99210	HF116	3,82
CRF 250 X	04-16	E10-99210	HF116	3,82
XR 250 L	91-99	E10-99200	HF112	3,27
XR 250	82-04	E10-99200	HF112	3,27
XR 400 R	96-04	E10-99200	HF112	3,27
CRF 450 R	02-16	E10-99210	HF116	3,82
CRF 450 X	05-16	E10-99210	HF116	3,82
XR 600 R	85-90	E10-99200	HF112	3,27
XR 600 R	94-02	E10-99200	HF112	3,27
XR 650 R	00-07	E10-99200	HF112	3,27

HUSABERG	Año	Referencia	Hiflo filtro	€
todas 4t	95-03	DMX07010	HF155	3,82
FE 250	13	DMX07010	HF655	3,82
FE 250	14	DMX07011	HF652	3,27
FE 350	13	DMX07011	HF652	3,27
FE 390	10-12	DMX07010	HF655	3,82
FC 450	04-06	DMX07010	HF155	3,82
FE 450	04-08	DMX07010	HF155	3,82
FE 450 Enduro	09-14	DMX07010	HF655	3,82
FS 450	04-08	DMX07010	HF155	3,82
FX 450	10-11	DMX07010	HF655	3,82
FE 501	13-14	DMX07010	HF655	3,82
FC 550	04-06	DMX07010	HF155	3,82
FE 550	04-08	DMX07010	HF155	3,82
FS 550	04-08	DMX07010	HF155	3,82
FE 570	09-12	DMX07010	HF655	3,82
FE 650	04-08	DMX07010	HF155	3,82

HUSQVARNA	Año	Referencia	Hiflo filtro	€
TE 125 4t	11-13	DAT07132	HF140	3,27
FC 250	14-16	DMX07011	HF652	3,27
FE 250	14-16	DMX07011	HF652	3,27
TC 250	02-07	DMX07170	HF154	3,27
TC 250	08	DMX07171	HF563	3,82
TC 250	09-13	E10-99210	HF116	3,82
TC 250 R	13	E10-99210	HF116	3,82
TE 250	02-07	DMX07170	HF154	3,27



Filtros de aceite

KTM

*DMX07013



** DMX07010

TE 250	08-09	DMX07171	HF563	3,82
TE 250	10-14	E10-99210	HF116	3,82
TXC 250	08-09	DMX07171	HF563	3,82
TXC 250	10-14	E10-99210	HF116	3,82
TE 310	09-10	DMX07171	HF563	3,82
TE 310	11-14	E10-99210	HF116	3,82
TXC 310 R	11-14	E10-99210	HF116	3,82
FC 350	15-16	DMX07011	HF652	3,27
FE 350	14-16	DMX07011	HF652	3,27
TE 410 E	98-01	DMX07170	HF154	3,27
TC 449	11-14	DMX07019	HF611	3,82
TE 449	11-14	DMX07019	HF611	3,82
FC 450	14-15	DMX07011	HF652	3,27
FC 450	16	DMX07010	HF655	3,82
FE 450	14-16	DMX07010	HF655	3,82
FR 450 Rally	16	DMX07168	HF650	3,82
FS 450	16	DMX07011	HF652	3,27
TC 450	02-07	DMX07170	HF154	3,27
TC 450	08-10	DMX07171	HF563	3,82
TE 450	02-07	DMX07170	HF154	3,27
TE 450	08-10	DMX07171	HF563	3,82
TXC 450	08-11	DMX07171	HF563	3,82
FE 501	14-16	DMX07010	HF655	3,82
TC 510	05-07	DMX07170	HF154	3,27
TC 510	08-10	DMX07171	HF563	3,82
TCX 510	08-11	DMX07171	HF563	3,82
TE 510	04-07	DMX07170	HF154	3,27
TE 510	08-10	DMX07171	HF563	3,82
TXC 510	08-09	DMX07171	HF563	3,82
TE 511	11-14	DMX07019	HF611	3,82
TE 610 E	98-01	DMX07170	HF154	3,27
TE 610 E LT	00	DMX07170	HF154	3,27
TE 610 IE	06-08	DMX07170	HF154	3,27
TE 630 IE	10-11	DMX07171	HF563	3,82

KAWASAKI	Año	Referencia	Hiflo filtro	€
KLX 125	10-15	E10-99200	HF112	3,27
KLR 250	84-05	E10-30000	HF123	3,27
KLX 250	90-97	E10-99200	HF112	3,27
KLX 250	06-07	E10-99200	HF112	3,27
KLX 250	09-15	E10-99200	HF112	3,27
KX 250 F	04-16	DMX07157	HF207	3,27
KLX 300 R	96-07	E10-99200	HF112	3,27
KLX 450 R	08-14	E10-99200	HF112	3,27
KX 450 F	06-15	E10-99200	HF112	3,27
KX 450 F	16	DMX07157	HF207	3,27

KTM	Año	Referencia	Hiflo filtro	€
250 EXC Racing	03-06	DMX07010** DMX07013*	HF155 HF157	3,82 3,82
250 EXC-F	07-12	DMX07010	HF655	3,82
250 EXC-F	13-16	DMX07011	HF652	3,27
250 SX-F	05-12	DMX07010	HF655	3,82
250 SX-F	13-16	DMX07011	HF652	3,27
250 XC-F	07-12	DMX07010	HF655	3,82
250 XCF-W	07-12	DMX07010	HF655	3,82
250 XC-F	13-16	DMX07011	HF652	3,27
250 XCF-W	13-16	DMX07011	HF652	3,27
300 EXC-F	15	DMX07011	HF652	3,27

350 EXC-F	12-16	DMX07011	HF652	3,27
350 Freeride	12-16	DMX07011	HF652	3,27
350 SX-F	11-16	DMX07011	HF652	3,27
350 XCF-W	12-16	DMX07011	HF652	3,27
400 EXC	04-07	DMX07010** DMX07013*	HF155 HF157	3,82 3,82
400 SX	04-07	DMX07010** DMX07013*	HF155 HF157	3,82 3,82
400 XC	04-07	DMX07010** DMX07013*	HF155 HF157	3,82 3,82
400 XC-W	08-10	DMX07011	HF652	3,27
450 EXC	03-07	DMX07010** DMX07013*	HF155 HF157	3,82 3,82
450 SX	03-07	DMX07010** DMX07013*	HF155 HF157	3,82 3,82
450 EXC-R	09-11	DMX07011	HF652	3,27
450 EXC	12-16	DMX07010	HF655	3,82
450 Rally Factory Replica	11-16	DMX07168	HF650	3,82
450 SX-F	07-12	DMX07011	HF652	3,27
450 SX-F	13-15	DMX07010	HF655	3,82
450 SX-F	16	DMX07011	HF652	3,27
450 XC	07-08	DMX07010** DMX07013*	HF155 HF157	3,82 3,82
450 XC-W	07-08	DMX07010** DMX07013*	HF155 HF157	3,82 3,82
450 XC-F	08-10	DMX07011	HF652	3,27
450 XC-WR	08-10	DMX07011	HF652	3,27
450 XC-F	13-15	DMX07010	HF655	3,82
450 XC-F	16	DMX07011	HF652	3,27
450 XC-W	10-11	DMX07011	HF652	3,27
450 XC-W	12-16	DMX07010	HF655	3,82
500 EXC	12-16	DMX07010	HF655	3,82
500 XC-W	12-16	DMX07010	HF655	3,82
505 SX-F	08-09	DMX07011	HF652	3,27
505 XC-F	08-09	DMX07011	HF652	3,27
520 EXC	99-02	DMX07010** DMX07013*	HF155 HF157	3,82 3,82
520 SX	99-02	DMX07010** DMX07013*	HF155 HF157	3,82 3,82
525 EXC	03-07	DMX07010** DMX07013*	HF155 HF157	3,82 3,82
525 SX	03-07	DMX07010** DMX07013*	HF155 HF157	3,82 3,82
525 XC	03-07	DMX07010** DMX07013*	HF155 HF157	3,82 3,82
525 XC-W	03-07	DMX07010** DMX07013*	HF155 HF157	3,82 3,82
530 EXC-R	08-11	DMX07011	HF652	3,27
530 XC-RW	08-11	DMX07011	HF652	3,27
530 XC-W	08-11	DMX07011	HF652	3,27
625 SXC	03-05	DMX07010** DMX07013*	HF155 HF157	3,82 3,82
660 Rally E Factory Replica	06-07	DMX07010** DMX07013*	HF155 HF157	3,82 3,82
690 Enduro/R	08-11	DMX07010** DMX07013*	HF155 HF157	3,82 3,82
690 Enduro R	12-16	DMX07169 DMX07010	HF651 HF155	3,27 3,82
690 Rally Factory Replica	07-08	DMX07169 DMX07010	HF651 HF155	3,27 3,82
950 Super Enduro	07-11	DMX07168	HF650	3,82
990 Adventure Dakar Edition	11	DMX07168	HF650	3,82

RIEJU	Año	Referencia	Hiflo filtro	€
125 Marathon Pro Enduro	09-11	DAT07132	HF141	3,27
250 Marathon	09-11	DAT07132	HF141	3,27
450 Marathon	09-11	DAT07132	HF141	3,27

RUEDAS Y NEUMÁTICOS

MOTOR

ADMISIÓN / ESCAPE
REFRIGERACIÓN

ELECTRICO

SUSPENSIÓN / DIRECCIÓN

FRENOS

TRANSMISIÓN

CONTROLES Y MANDOS

CHASIS

ACCESORIOS



Filtros de aceite



A



C

SHERCO	Año	Referencia	Hiflo filtro	€
SE 2.5i F	08-15	DMX07019	HF611	3,82
SX 2.5i F	10	DMX07019	HF611	3,82
SE 3.0i F	10-15	DMX07019	HF611	3,82
SE 4.5i F	04-15	DMX07019	HF611	3,82
SM 4.5i F	04-15	DMX07019	HF611	3,82
SE 5.1i F	04-13	DMX07019	HF611	3,82
SM 5.1i F	04-10	DMX07019	HF611	3,82

SUZUKI	Año	Referencia	Hiflo filtro	€
DR-Z 125	03-16	E10-55500	HF132	3,27
DR-Z 250	01-07	E10-99300	HF136	3,27
RM-Z 250	04-16	DMX07157	HF207	3,27
DR-Z 400	00-07	E10-55510	3,27	3,27
RMX 450	10-13	DMX07157	HF207	3,27
RM-Z 450	05-16	DMX07157	HF207	3,27

TM	Año	Referencia	Hiflo filtro	€
250 4t	07	E10-79120	HF142	3,27
250 4t	08-15	DAT07132	HF141	3,27
450 4t	07-10	E10-79120	HF142	3,27
450 4t	11-15	DAT07132	HF141	3,27
530 4t	07-15	DAT07132	HF141	3,27
660 4t	08-09	E10-79120	HF142	3,27

YAMAHA	Año	Referencia	Hiflo filtro	€
WR 125 R	09-16	DAT07132	HF141	3,27
TT-R 250	00-06	E10-79120	HF142	3,27
WR 250 F	01-02	E10-79120	HF142	3,27
WR 250 F	03-08	DAT07132	HF141	3,27
WR 250 F	09-16	DAT07132	HF140	3,27
WR 250 R	09-16	DAT07132	HF140	3,27
WR 250 X	09-15	DAT07132	HF140	3,27
YZ 250 F	01-02	E10-79120	HF142	3,27
YZ 250 F	03-08	DAT07132	HF141	3,27
YZ 250 F	09-16	DAT07132	HF140	3,27
WR 400 F	99-01	E10-79120	HF142	3,27
YZ 400 F	98-99	E10-79120	HF142	3,27
WR 426 F	01-02	E10-79120	HF142	3,27
YZ 426 F	00-02	E10-79120	HF142	3,27
WR 450 F	03-08	DAT07132	HF141	3,27
WR 450 F	09-16	DAT07132	HF140	3,27
YZ 450 F	03-08	DAT07132	HF141	3,27
YZ 450 F	09-16	DAT07132	HF140	3,27

Aflojafiltros

Referencia	Dimensión	€
DMC1236318	65 mm	5,12
E84-04182	67 mm	5,12



Aflojafiltros

Referencia	Dimensión	€
DUP12073	60-76 mm	12,63
DUP120731	73-85 mm	12,63





Tapón drenaje imantado

Tapón de drenaje aceite de motor. Aluminio AL6061-T6. Anodizado dorado. La punta interior está imantada para recoger todas las pequeñas impurezas metálicas que pueda generar el motor, minimizando la posibilidad de taponar la bomba de aceite.

€
12



DMX12959
M8 x 25mm



DMX12960
M8 x 35mm



DMX12961
M10 x 16mm



DMX12962
M10 x 22mm



DMX12963
M12 x 10mm



DMX12964
M8 x 20mm



DMX12965
M10 x 16mm



DMX12966
M12 x 22mm



DMX12967
M6 x 10mm

HONDA	Año	Referencia	Ref. Original
CRF 150 R	07-15	DMX12960	96300-08035-00
CRF 150 R	07-15	DMX12967	90004-GHB-600
CRF 250 R	04-13	DMX12959	96300-08025-00
CRF 250 R	04-13	DMX12967	90004-GHB-600
CRF 250 X	04-13	DMX12959	96300-08025-00
CRF 250 X	04-13	DMX12967	90004-GHB-600
CRF 450 R	02-15	DMX12960	96300-08035-00
CRF 450 R	02-15	DMX12967	90004-GHB-600
CRF 450 X	04-09	DMX12960	96300-08035-00

KAWASAKI	Año	Referencia	Ref. Original
KX 65	00-16	DMX12961	92066-1437
KX85	01-16	DMX12961	92066-1437
KX 100	98-16	DMX12961	92066-1437
KX 125	96-05	DMX12961	92066-1437
KX 250	96-07	DMX12961	92066-1437
KX 250	09-10	DMX12961	92066-1437
KX 250 F	04-08	DMX12961	92066-1437
KX 450 F	06-15	DMX12962	92066-0038
KLX 450	08-13	DMX12962	92066-0038
KX 500	92-04	DMX12961	92066-1437

KTM	Año	Referencia	Ref. Original
TODOS	Todos	DMX12966	58030021000

SUZUKI	Año	Referencia	Ref. Original
DR-Z 70	08-09	DMX12963	09247-12006
DR-Z400	00-15	DMX12963	09247-12006
RM-Z 250	07-13	DMX12963	09247-12006
RM-Z 450	08-15	DMX12964	09103-08393

YAMAHA	Año	Referencia	Ref. Original
YZ 125	07-14	DMX12965	95022-10016-00
YZ 250 F	06-16	DMX12965	95022-10016-00
WR 250 F	06-13	DMX12965	95022-10016-00
YZ 450 F	06-14	DMX12965	95022-10016-00
WR 450 F	06-12	DMX12965	95022-10016-00

XPEED Tapón llenado aceite

Tapón de llenado aceite de motor, fabricado en aluminio y anodizado en diferentes colores. Se entrega con tórica.

€
6,90

HONDA	Año	Color	Referencia
CR 125	87-04	Oro	R176301D
CR 125	05-07	Rojo	R176302R
CRF 150 F	03-14	Rojo	R176302R
CRF 150 R	07-15	Rojo	R176302R
CRF 230 F	03-10	Rojo	R176302R
CRF 230 L	08-12	Rojo	R176302R
CR 250	05-07	Rojo	R176302R
CRF 250 R	04-15	Rojo	R176302R
CRF 250 X	04-15	Rojo	R176302R
CRF 450 R	02-04	Oro	R176301D
CRF 450 R	05-15	Rojo	R176302R
CRF 450 X	05-15	Rojo	R176302R
TRX 450 R	04-10	Rojo	R176302R
CR 500	87-04	Oro	R176301D

KAWASAKI	Año	Color	Referencia
KX 80	83-03	Oro	R176301D
KX 85	00-04	Oro	R176301D
KX 100	91-05	Oro	R176301D
KX 125	80-04	Oro	R176301D
KX 125	05-08	Oro	R176304D
KDX 220	83-04	Oro	R176301D
KLX 250	94-06	Oro	R176301D
KLX 250 S	08-10	Oro	R176302D
KX 250	80-04	Oro	R176301D
KX 250	05-07	Oro	R176304D
KX 250 F	04-15	Oro	R176304D
KLX 300	94-06	Oro	R176301D
KLX 300	2007	Oro	R176302D
KX 450 F	06-15	Oro	R176304D
KX 500	83-04	Oro	R176301D

KTM	Año	Color	Referencia
65 SX	02-15	Naranja	R176305O
65 XC	02-15	Naranja	R176305O
85 SX	03-15	Naranja	R176305O
85 XC	03-15	Naranja	R176305O
105 SX	03-15	Naranja	R176305O
105 XC	03-15	Naranja	R176305O
125 a 200 2t.	94-05	Naranja	R176305O
250 a 380 2t.	94-12	Naranja	R176305O
450 EXC	08-12	Naranja	R176305O
450 XC-W	08-12	Naranja	R176305O
530 EXC	08-12	Naranja	R176305O
530 XC-W	08-12	Naranja	R176305O

SUZUKI	Año	Color	Referencia
RM 55	2003	Oro	R176301D
RM 60	03-06	Oro	R176301D
RM 80	90-01	Oro	R176303D
RM 85	02-15	Oro	R176303D
RM 100	2003	Oro	R176301D
RM 125	82-07	Oro	R176303D
RM 250	82-08	Oro	R176303D
RMZ 250	04-06	Oro	R176304D
RMZ 250	07-15	Oro	R176303D
RMZ 450	05-15	Oro	R176303D
RMX 450	10-13	Oro	R176303D

YAMAHA	Año	Color	Referencia
YZ 80	93-01	Azul	R176301B
YZ 85	02-14	Azul	R176301B
YZ 125	94-15	Azul	R176301B
YFS 200	89-06	Azul	R176301B
WR 250 F	03-05	Azul	R176301B
WR 250 F	06-10	Oro	R176302D
WR 250 R	08-10	Azul	R176301B
WR 250 X	08-10	Azul	R176301B
YZ 250	99-15	Azul	R176301B
YZ 250 F	03-15	Azul	R176301B
WR 450 F	03-15	Azul	R176301B
YZ 450 F	03-15	Azul	R176301B



Kit bomba de agua Honda CRF 450 R 02-08

El kit consta de todo el material necesario para reparar la bomba de agua.
Junta de tapa, eje de la bomba, rodamiento y los dos retenes.

Referencia	Descripción	€
DMX09258	Honda CRF 450R	29,89



Kit retenes bomba de agua

El kit consta de todo el material necesario para sustituir los retenes de la bomba de agua.
Se sirve sin eje y con juntas.

DMX10217

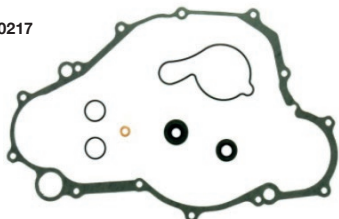

DMX10218

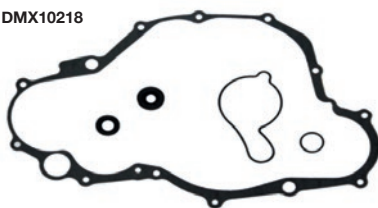

DMX10222



HONDA	Año	Referencia	Nº Piezas	€
CR 80	86-07	DMX10207	5	18,61
CR 85	86-07	DMX10207	5	18,61
CR 125 R	90-04	DMX10206	6	19,40
CR 250 R	92-01	DMX10205	6	18,22
CR 250 R	02-04	DMX10203	6	18,22
CR 250 R	05-07	DMX10203	6	18,22
CRF 250 R	04-09	DMX10201	6	17,29
CRF 250 R	10-17	DMX10216	6	40,18
CRF 250 X	04-09	DMX10201	6	17,29
CRF 450 R	02-08	DMX10200	6	19,01
CRF 450 R	09-16	DMX10228	5	37,85
CRF 450 X	05-16	DMX10231	7	27,30

HUSABERG	Año	Referencia	Nº Piezas	€
TE 250	11-13	DMX10224	3	11,09
TE 300	11-13	DMX10224	3	11,09

KAWASAKI	Año	Referencia	Nº Piezas	€
KX 65	00-17	DMX10239	7	21,07
KX 80	89-00	DMX10238	6	18,00
KX 85	01-17	DMX10238	6	18,00
KX 100	95-17	DMX10238	6	18,00
KX 125	03-05	DMX10211	5	18,88
KX 250 F	04-08	DMX10208	7	20,86
KX 250 F	09-17	DMX10225	8	21,25
KLX 450 R	08-12	DMX10209	4	21,25
KX 450 F	06-08	DMX10209	4	21,25
KX 450 F	09-15	DMX10226	8	21,25
KX 450 F	16-17	DMX10235	7	34,67

KTM	Año	Referencia	Nº Piezas	€
50 Pro-Sr. LC	01-05	DMX10220	3	6,60
50 Supermoto	2006	DMX10220	3	6,60
50 SX	09-12	DMX10221	3	9,77
50 SX Jr.	2009	DMX10221	3	9,77
50 SX Mini	09-12	DMX10221	3	9,77
50 SX Pro-Jr. LC	03-5	DMX10220	3	6,60
50 SX/ SX Jr	06-08	DMX10220	3	6,60
65 SX	00-08	DMX10220	3	6,60
65 SX	09-12	DMX10221	3	9,77
65 XC	2008	DMX10220	3	6,60
65 XC	2009	DMX10221	3	9,77
85 SX	03-04	DMX10222	5	9,77
85 SX 17/14	05-12	DMX10222	5	9,77
85 SX 19/16	05-12	DMX10222	5	9,77
85 XC	08-09	DMX10222	5	9,77
105 SX	04-11	DMX10222	5	9,77

105 XC	08-09	DMX10222	5	9,77
125 EXC	00-01	DMX10223	7	10,96
125 SX	00-12	DMX10223	7	10,96
125 SXS	01-02	DMX10223	7	10,96
125 SXS	07-08	DMX10223	7	10,96
144 SX	07-08	DMX10223	7	10,96
150 SX	09-12	DMX10223	7	10,96
150 XC	10-12	DMX10223	7	10,96
200 EXC	00-05	DMX10223	7	10,96
200 MXC	00-03	DMX10223	7	10,96
200 SX	03-04	DMX10223	7	10,96
250 SX	03-16	DMX10224	3	11,09
250 EXC	04-05	DMX10224	3	11,09
250 XC	06-16	DMX10224	3	11,09
250 XC-W	06-16	DMX10224	3	11,09
250 SXS	2004	DMX10224	3	11,09
300 EXC	04-07	DMX10224	3	11,09
300 MXC	04-05	DMX10224	3	11,09
300 XC	06-12	DMX10224	3	11,09
300 SX-W	06-12	DMX10224	3	11,09
300 XC-W	07-16	DMX10224	3	11,09

SUZUKI	Año	Referencia	Nº Piezas	€
RM 85	02-16	DMX10242	5	20,58
RM 125	04-08	DMX10215	4	17,29
RM 250	01-08	DMX10214	3	17,29
RM-Z 250	04-06	DMX10208	7	20,86
RM-Z 250	07-16	DMX10212	4	20,86
RM-Z 450	05-07	DMX10213	4	20,86
RM-Z 450	08-16	DMX10230	4	21,76

YAMAHA	Año	Referencia	Nº Piezas	€
YZ 80	97-01	DMX10240	6	17,64
YZ 85	02-17	DMX10240	6	17,64
YZ 125	88-04	DMX10232	5	17,82
YZ 125	05-16	DMX10233	5	22,30
WR 250 F	01-13	DMX10219	7	18,88
YZ 250	99-16	DMX10227	4	18,37
YZ 250 F	01-13	DMX10219	7	18,88
YZ 250 F	14-17	DMX10241	9	27,56
WR 450 F	03-06	DMX10217	7	18,88
WR 450 F	07-15	DMX10218	5	19,01
WR 450 F	16-17	DMX10234	5	22,05
YZ 450 F	03-05	DMX10217	7	18,88
YZ 450 F	07-09	DMX10218	5	19,01
YZ 450 F	04-09	DMX10218	5	19,01
YZ 450 F	10-13	DMX10229	5	19,01
YZ 450 F	14-17	DMX10234	5	22,05

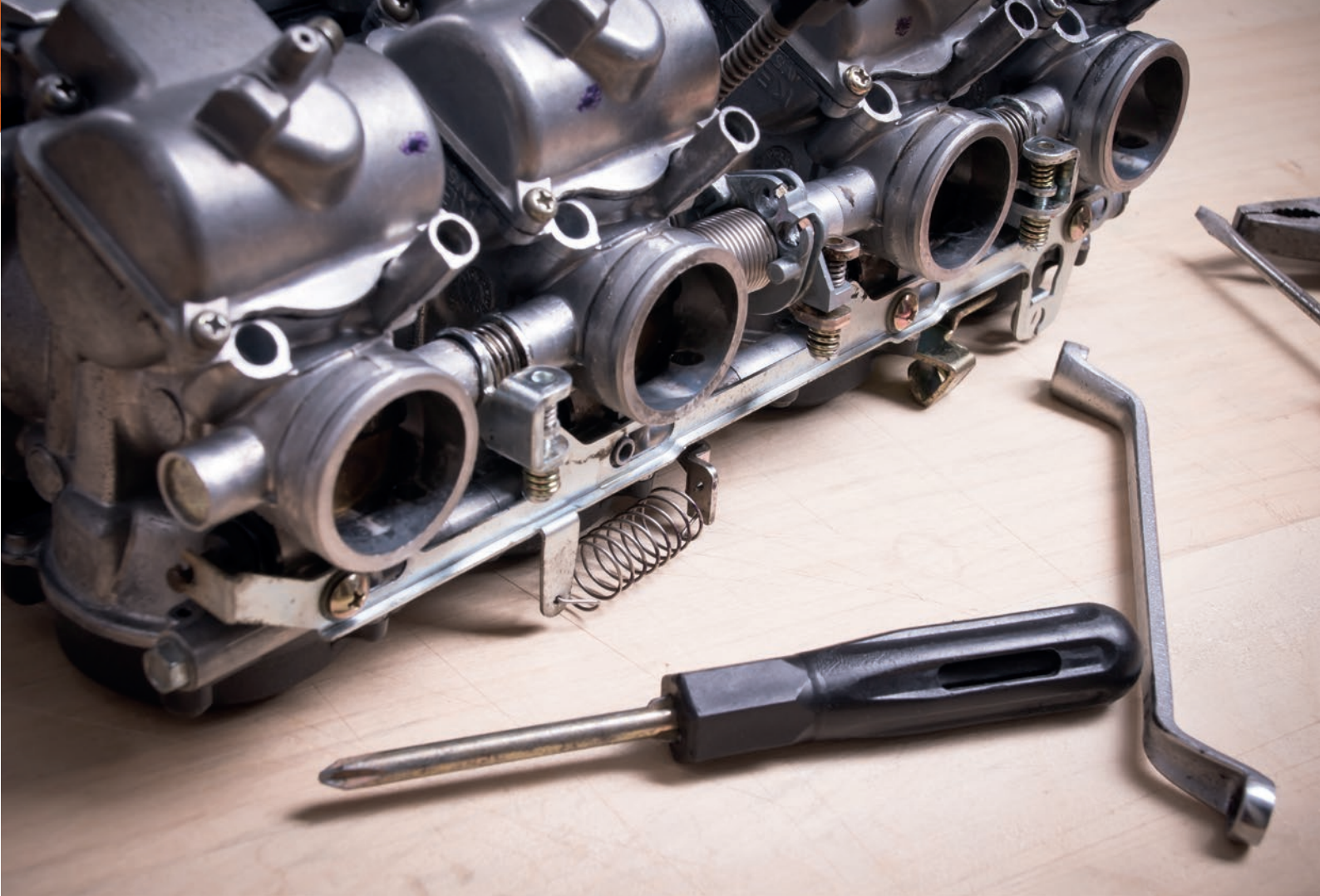

ADMISIÓN ESCAPE REFRIGERACIÓN

ADMISIÓN / ESCAPE / REFRIGERACIÓN



Chiclés carburador

€
5

Modelo Mikuni SJ

Referencia	Medida	Referencia	Medida	Referencia	Medida	Referencia	Medida
DSJ0725	72,5	DSJ0975	97,5	DSJ1225	122,5	DSJ1475	147,5
DSJ0750	75	DSJ1000	100	DSJ1250	125	DSJ1500	150
DSJ0775	77,5	DSJ1025	102,5	DSJ1275	127,5	DSJ1525	152,5
DSJ0800	80	DSJ1050	105	DSJ1300	130	DSJ1550	155
DSJ0825	82,5	DSJ1075	107,5	DSJ1325	132,5	DSJ1575	157,5
DSJ0850	85	DSJ1100	110	DSJ1350	135	DSJ1600	160
DSJ0875	87,5	DSJ1125	112,5	DSJ1375	137,5	DSJ1700	170
DSJ0900	90	DSJ1150	115	DSJ1400	140		
DSJ0925	92,5	DSJ1175	117,5	DSJ1425	142,5		
DSJ0950	95	DSJ1200	120	DSJ1450	145		

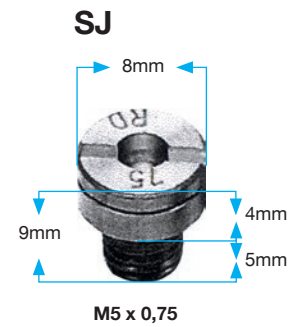

Modelo Mikuni HJ

Referencia	Medida	Referencia	Medida	Referencia	Medida	Referencia	Medida
DHJ0700	70	DHJ1750	175	DHJ3300	330	DHJ5100	510
DHJ0800	80	DHJ1800	180	DHJ3400	340	DHJ5200	520
DHJ0900	90	DHJ1850	185	DHJ3500	350	DHJ5300	530
DHJ1000	100	DHJ1900	190	DHJ3600	360	DHJ5400	540
DHJ1050	105	DHJ1950	195	DHJ3700	370	DHJ5500	550
DHJ1100	110	DHJ2000	200	DHJ3800	380	DHJ5600	560
DHJ1150	115	DHJ2100	210	DHJ3900	390	DHJ5700	570
DHJ1200	120	DHJ2200	220	DHJ4000	400	DHJ5800	580
DHJ1250	125	DHJ2300	230	DHJ4100	410	DHJ5900	590
DHJ1300	130	DHJ2400	240	DHJ4200	420	DHJ6000	600
DHJ1350	135	DHJ2500	250	DHJ4300	430	DHJ6100	610
DHJ1400	140	DHJ2600	260	DHJ4400	440	DHJ6200	620
DHJ1450	145	DHJ2700	270	DHJ4500	450	DHJ6300	630
DHJ1500	150	DHJ2800	280	DHJ4600	460	DHJ6400	640
DHJ1550	155	DHJ2900	290	DHJ4700	470	DHJ6500	650
DHJ1600	160	DHJ3000	300	DHJ4800	480	DHJ6600	660
DHJ1650	165	DHJ3100	310	DHJ4900	490	DHJ6700	670
DHJ1700	170	DHJ3200	320	DHJ5000	500	DHJ6800	680



Modelo Keihin KJ

Referencia	Medida	Referencia	Medida	Referencia	Medida	Referencia	Medida
DKJ0725	72,5	DKJ0975	97,5	DKJ1225	122,5	DKJ1475	147,5
DKJ0750	75	DKJ1000	100	DKJ1250	125	DKJ1500	150
DKJ0775	77,5	DKJ1025	102,5	DKJ1275	127,5	DKJ1525	152,5
DKJ0800	80	DKJ1050	105	DKJ1300	130	DKJ1550	155
DKJ0825	82,5	DKJ1075	107,5	DKJ1325	132,5	DKJ1575	157,5
DKJ0850	85	DKJ1100	110	DKJ1350	135	DKJ1600	160
DKJ0875	87,5	DKJ1125	112,5	DKJ1375	137,5	DKJ1650	165
DKJ0900	90	DKJ1150	115	DKJ1400	140	DKJ1700	170
DKJ0925	92,5	DKJ1175	117,5	DKJ1425	142,5	DKJ1900	190
DKJ0950	95	DKJ1200	120	DKJ1450	145		

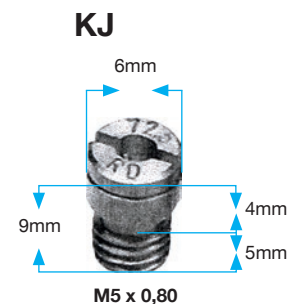

Modelo Keihin CR

Referencia	Medida	Referencia	Medida	Referencia	Medida	Referencia	Medida
DCR0800	80	DCR1200	120	DCR1600	160	DCR2000	200
DCR0820	82	DCR1220	122	DCR1620	162	DCR2020	202
DCR0850	85	DCR1250	125	DCR1650	165	DCR2050	205
DCR0880	88	DCR1280	128	DCR1680	168	DCR2080	208
DCR0900	90	DCR1300	130	DCR1700	170	DCR2100	210
DCR0920	92	DCR1320	132	DCR1720	172	DCR2120	212
DCR0950	95	DCR1350	135	DCR1750	175	DCR2150	215
DCR0980	98	DCR1380	138	DCR1780	178	DCR2180	218
DCR1000	100	DCR1400	140	DCR1800	180	DCR2200	220
DCR1020	102	DCR1420	142	DCR1820	182	DCR2220	222
DCR1050	105	DCR1450	145	DCR1850	185	DCR2250	225
DCR1080	108	DCR1480	148	DCR1880	188	DCR2280	228
DCR1100	110	DCR1500	150	DCR1900	190	DCR2300	230
DCR1120	112	DCR1520	152	DCR1920	192	DCR2320	232
DCR1150	115	DCR1550	155	DCR1950	195	DCR2350	235
DCR1180	118	DCR1580	158	DCR1980	198	DCR2380	238

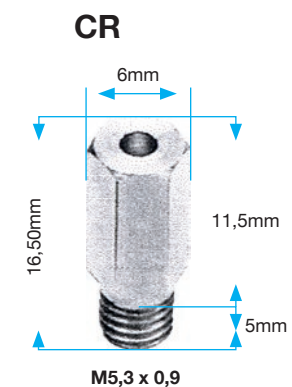



Kit de reparación carburador

El kit de reparación de carburador incluye todo el material indispensable para rehacer todo el carburador.

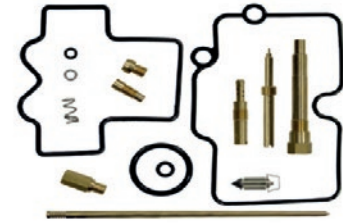

HONDA	Año	Referencia	€
CR 80 R	96-02	DXU07313	24,05
CR 85 R	03-05	DXU07313	24,05
CR 80 RB EXPERT	96-02	DXU07313	24,05
CR 85 RB EXPERT	03-05	DXU07313	24,05
CR 125 R	00-01	DXU07317	22,43
CR 125 R	02-03	DXU07318	22,43
CR 125 R	04-07	DXU07319	33,09
CRF 150 F	06-16	DXU07320	27,30
CRF 230 F	03-05	DXU07323	32,18
CRF 230 F	06-17	DXU07324	20,80
CR 250 R	99-00	DXU07326	20,80
CR 250 R	01-03	DXU07327	22,43
CR 250 R	04-07	DXU07328	33,09
CRF 250 R	2004	DXU07329	31,47
CRF 250 R	2005	DXU07330	31,47
CRF 250 R	2006	DXU07332	32,13
CRF 250 R	07-08	DXU07331	32,13
CRF 250 X	04-06	DXU07333	33,00
XR 400 R	98-04	DXU07336	33,09
CRF 450 R	02-04	DXU07337	31,47
CRF 450 R	05-06	DXU07338	26,43
CRF 450 R	07-08	DXU07339	31,47
CRF 450 X	05-06	DXU07340	33,90
CRF 450 X	07-16	DXU07341	33,90
XR 650 R	00-06	DXU07342	28,93

KAWASAKI	Año	Referencia	€
KX 65	02-16	DXU07343	31,72
KX 85	01-13	DXU07344	24,05
KX 125	01-02	DXU07346	20,80
KX 125	03-05	DXU07347	27,30
KX 250	00-04	DXU07348	22,71
KLX 250 S	09-14	DXU07353	32,28
KX 250 F	04-08	DXU07349	31,47
KLR 650	87-07	DXU07350	21,21

KTM	Año	Referencia	€
250 SX-F	05-10	DXU07354	41,79
250 XC-F	07-09	DXU07354	41,79
250 XCF-W	06-11	DXU07354	41,79
400 EXC-G	2006	DXU07355	42,70
400 XC-W	07-10	DXU07355	42,70
450 EXC	06-11	DXU07355	42,70
450 EXC-G	06-11	DXU07355	42,70
450 EXC-R	2008	DXU07355	42,70
450 SMR	06-09	DXU07355	42,70
450 SX-F	06-12	DXU07355	42,70
450 SXS-F	07-08	DXU07355	42,70
450 XC	07-09	DXU07355	42,70
450 XC-F	07-08	DXU07355	42,70

450 XC-G	06-11	DXU07355	42,70
450 XC-W	06-11	DXU07355	42,70
450 XCR-W	2008	DXU07355	42,70
505 SX-F	2008	DXU07355	42,70
505 XC-F	08-09	DXU07355	42,70
525 EXC 4T	06-07	DXU07355	42,70
525 SX	2006	DXU07355	42,70
525 XC	2007	DXU07355	42,70
525 XC-W	06-08	DXU07355	42,70
530 EXC	08-11	DXU07355	42,70
530 EXC-R	08-11	DXU07355	42,70
530 XCR-W	2008	DXU07355	42,70
530 XC-W	09-11	DXU07355	42,70
540 SX-S	2006	DXU07355	42,70

SUZUKI	Año	Referencia	€
RM 85	02-16	DXU07356	20,80
RM 85 L	03-16	DXU07356	20,80
RM 125	01-06	DXU07357	23,34
RM 250	01-06	DXU07360	22,43
RM-Z 250	05-06	DXU07349	31,47
RM-Z 250	07-09	DXU07361	33,00
DR-Z 400 S	00-09	DXU07363	33,81
RM-Z 450	05-07	DXU07364	33,00
DR 650 SE	96-09	DXU07365	29,17
XR 650 L	93-09	DXU07366	24,96

YAMAHA	Año	Referencia	€
YZ 80	97-01	DXU07369	20,80
YZ 85	02-04	DXU07371	20,80
YZ 85	06-16	DXU07372	29,84
TT-R 90 R	06-07	DXU07374	32,72
TT-R 125	00-05	DXU07375	35,30
TT-R 125 E	06-07	DXU07396	45,09
TT-R 125 L	06-07	DXU07396	45,09
TT-R 125 LE	06-07	DXU07396	45,09
YZ 125	99-00	DXU07376	22,43
YZ 125	02-04	DXU07377	24,88
YZ 125	05-16	DXU07378	28,79
YZ 250	00-01	DXU07383	24,96
YZ 250	02-04	DXU07384	24,96
YZ 250	07-08	DXU07385	29,84
YZ 250 F	01-02	DXU07386	33,90
YZ 250 F	03-06	DXU07387	32,13
YZ 250 F	07-08	DXU07388	32,13
WR 250 F	05-09	DXU07393	37,73
YZ 426 F	00-02	DXU07390	33,00
YZ 450 F	03-04	DXU07391	28,43
YZ 450 F	05-09	DXU07392	32,13
WR 450 F	05-06	DXU07394	37,87
WR 450 F	07-09	DXU07395	37,87

Extractor de chiclés

Referencia	€
DUP12069	9,63



Limpiador de chiclés

Referencia	€
DMP12327	7,20



Galgas Chiclés

Referencia	Medidas (mm)	€
DUP12171	Desde 0,45 - 1,5	10,80
DUP121711	Desde 1,5 a 3,0	10,80



ADMISIÓN / ESCAPE / REFRIGERACIÓN



Tornillo regulación aire aluminio

Tornillo para la mezcla de aire y gasolina, de rápido acceso.
Para carburadores KEIHIN modelo FCR.
Fabricado en aluminio AL6061 T6.

Referencia	Descripción	€
DMX07014RD	Rojo	14,84
DMX07014BU	Azul	14,84
DMX07014BK	Negro	14,84
DMX07014TI	Titanio	14,84



Tornillo regulación aire latón

Tornillo para la mezcla de aire y gasolina, de rápido acceso.
Para carburadores KEIHIN modelo FCR.
Fabricado en latón.



DMC07225

Listado de aplicaciones de tornillos de regulación. Compruebe las fotografías superiores para averiguar qué tornillo utiliza su vehículo.

HONDA	Año
CRF 150 R	07-15
CRF 250 R	04-09
CRF 250 X	04-13
CRF 450 R	02-08
CRF 450 X	05-13

KAWASAKI	Año
KX 250 F	04-10
KLX 450 R	08-10
KX 450 F	06-08

KTM	Año
250 EXC	03-08
250 EXC-R	09-12
250 XCF	07-12
250 XCF-W	07-08
250 XCW	10-12
300 XC	10-12
300 XCW	10-12
400 EXC	00-06
400 MXC	00-02
400 SX	00-02
400 XC	06-07
400 XCW	2007
400 XCW	09-10
450 EXC	03-07
450 EXC-R	08-11
450 MXC	03-05
450 SMC	04-07
450 SMR	04-07
450 SX	03-06

450 SXF	07-08
450 XC	06-07
450 XCF	08-09
450 XCW	07-11
505 SXF	07-08
505 XCF	08-09
520 EXC	00-02
520 MXC	00-02
520 SX	00-02
525 EXC	03-07
525 MXC	03-05
525 SMC	04-05
525 SMR	04-05
525 SX	03-06
525 XC	06-07
525 XCW	2007
530 EXC	08-11
530 XCW	08-11
560 SMC	06-07
560 SMR	06-07

SUZUKI	Año
DR 250	90-99
RM-Z 250	04-09
DR 350	90-99
DRZ 400 Dirt	00-09
DRZ 400 Street	00-11
DRZ 400 Super Motard	05-09
RM-Z 450	05-07
DR 650 S	90-06

YAMAHA	Año
WR 250 F	01-13
YZ 250 F	01-13
WR 400 F	98-00
YZ 400 F	98-99
WR 426 F	01-02
YZ 426 F	00-02
WR 450 F	03-11
YZ 450 F	03-09



Filtros de aire universales



Referencia	Descripción	€
DMP07084A1	De espuma roja y boquilla de 28mm	15,10
DMP07084A4	De espuma roja y boquilla de 35mm	15,10
DMP07084A7	De espuma roja y boquilla de 42mm	15,10
DMP07084A11	De espuma roja y boquilla de 50mm	15,10



Láminas de admisión

Marca y recorta las láminas de cualquier modelo.
Placa de carbono específicamente creada para la realización de láminas de admisión.



Referencia	Descripción	€
DMP07300	Placa de 50x90 mm y 0,35 mm de espesor	15,60
DMP07301	Placa de 60x100 mm y 0,38 mm de espesor	15,60

BRONCO

Grifos gasolina

YAMAHA	Año	Referencia	€
YZ 80	97-01	DMX07351	17,64
YZ 85	02-17	DMX07351	17,64
YZ 125	89-17	DMX07350	17,64
YZ 250	89-17	DMX07350	17,64
YZ 250 F	01-13	DMX07351	17,64
YZ 400	98-99	DMX07351	17,64
YZ 426 F	00-02	DMX07351	17,64
YZ 450 F	03-05	DMX07351	17,64



DMX07350



DMX07351

Referencia	Descripción	€
DAT07574	YAMAHA - A: Ø 7mm, B: Anclaje Ø 6,6mm a 34mm, C: Tubo 38/29,5mm / 66mm	14,40
DAT07575	YAMAHA - A: Ø 8mm, B: Anclaje Ø 6,6mm a 34mm, C: Tubo 35,8/30mm / 66mm	14,40

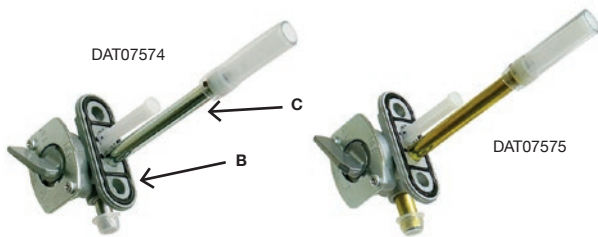

Filtro de gasolina

Referencia	Imagen	Descripción	€
E14-34441	A	F. Gasolina Grande Ø 6 mm.	1,12
E14-34421	B	F. Gasolina Pequeño Ø 6 mm.	0,79
DUP07101	C	F. Gasolina para tubo Ø 6 mm.	1,20
DUP071011	C	F. Gasolina para tubo Ø 8 mm.	1,50

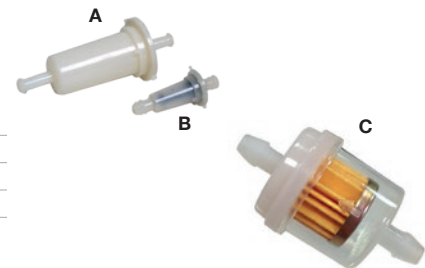

Conector rápido gasolina

Referencia	Descripción	€
DAT07040	Tubo Ø 6mm	11,33
DAT070401	Tubo Ø 8mm	11,33



XPEED Válvula tapón gasolina

Referencia	Descripción
R250BK	Tubo desvaporador Negro
DMC07371BU	Tubo desvaporador Azul
DMC07371RD	Tubo desvaporador Rojo
R250GR	Tubo desvaporador Dorado
DMC07371TI	Tubo desvaporador Titanio



€
6,09

Brida tubo gasolina 10 und.

Referencia	Descripción	€
DSM07046	Ø 8,5 mm	2,40
DSM07045	Ø 9,8 mm	3,10
DSM07049	Ø 11,6 mm	3,60
D07238A	Ø 18 mm	4,40



Tubo gasolina NBR 5m

Referencia	Descripción	€
DMC07043	Tubo Ø 4,8 mm	11,90
DMC070431	Tubo Ø 6,3 mm	11,90
DMC070432	Tubo Ø 8 mm	22,20



RUEDAS Y NEUMÁTICOS

MOTOR

ADMISIÓN / ESCAPE
REFRIGERACIÓN

ELECTRICO

SUSPENSIÓN / DIRECCIÓN

FRENOS

TRANSMISIÓN

CONTROLES Y MANDOS

CHASIS

ACCESORIOS

Juego de embudos

Referencia	Descripción	€
DUC12201	Ø 50, 75,95, 115 mm	4,80



2 Bolas testigo depósito gasolina de nilón

Referencia	Descripción	€
DUP12017	Ø 25 mm	1,99



Probetas medidoras líquido

Referencia	Descripción	€
DUP12015	500 ml	4,40



Portachiclés

	Referencia	€
1	XSM07067	4,50
2	XSM07022	7,00
3	X0718704	4,70



Destornillador curvo

Referencia	€
DUP12840	85,82



Depósito gasolina portátil 0,5l.

Referencia	€
DUP12185	24,81



Fibra silencioso 1100°C

Referencia	Largo	Ancho	Grosor	€
DMC021111	1000 mm	330 mm	6 mm	23,35



XPEED

Tapón silencioso



Referencia	Descripción	€
DMX02004	Pequeño Ø10 a 30mm	6,60
DMX02005	Grande Ø27 a 49mm	6,60



Juego de 2 muelles para colectores y silenciosos



Referencia	Largo	€
DUP02011	38mm	4,16
DUP02012	60mm	4,16
DUP02014	67mm	4,16
DUP02015	70mm	4,16
DUP02016	75mm	4,16
DUP02017	80mm	4,69
DUP02018	90mm	4,69
DUP02019	95mm	4,69
DUP02020	100mm	4,69

Saca muelles

Referencia	€
DUP12351	6,98





Tubos de escape

Para listado de aplicaciones y precios entra en gpr.impnesa.com



Albus Ceramic

Artículo bajo pedido, con plazo de entrega de 3 semanas.



Furore negro

Artículo bajo pedido, con plazo de entrega de 3 semanas.



Furore Carbon Simil

Artículo bajo pedido, con plazo de entrega de 3 semanas.



ES

La gama con más demanda de la colección GPR es la línea Furore, disponible en colores negro, aluminio, look de carbono o Albus, totalmente en color blanco. Esta línea es compacta, ligera y potente. Las partes inferiores y las entradas se fabrican en material CNC. La novedad consiste en el diferente procesamiento para la versión Albus, ésta versión tiene un tratamiento cerámico. Con el fin de mejorar la calidad y dar una mayor resistencia al calor. Ayudando a no envejecer su aspecto. La Línea Furore está disponible en opción racing y homologado. Las versiones homologadas y catalíticas se ofrecen con un sistema dual DB Killer extraíble.

FR

Le plus aimé parmi les collections GPR est la famille Furore, disponible en aluminium, noir et look carbone ou en version Albus, complètement blanche. Compact, léger, puissant et pas cher! Qu'est-ce que vous pourriez demander plus? Endcaps et entrée fabriqués en ergal avec CNC centre, ce genre de production accorder l'assemblage parfait et son incroyable! La nouveauté est le renouvellement de l'usinage pour la finition noir et Albus: pas plus dans la peinture simple, mais avec un nouveau traitement en céramique, afin d'accroître encore la qualité, avec traitement effectué sur la pièce finie et non sur les composants, avec une plus grande résistance à la lachaleur et de l'impact. Les versions homologué et catalysées sont équipée de double dbkiller amovible pour une utilisation sur piste.

EN

Furore and Albus line! Looking to these pipes you can understand why "style" in exhausts word means "GPR"! Compact, light, powerful and not expensive! What could you ask more? Endcaps and entrance made in ergal with CNC center, this kind of production grant perfect assembling and incredible sound! Albus and black finish are now realized with new ceramic treatment to improve heat resistance and durability. Furore line is available in homologated and racing options. Homologated and catalytic versions are offered with a dual removable dbkiller system unique on the market.



Ghisa

Artículo bajo pedido, con plazo de entrega de 3 semanas.



ES

Línea GHISA es nuestra nueva oferta para el mercado! Forma ovalada y pintura con tratamiento cerámico dando más resistencia en altas temperaturas fabricado en material ergal. Ahora está disponible también en versión GHISA EVO fabricados con material de ergal, con copa final en carbono. Este silencioso es la mejor relación calidad-precio de nuestro catálogo, con más de 300 opciones en colección. Se sirven en versión homologada y está provisto de db killer.

FR

Collection GHISA est notre nouvelle offre pour le marché!! Silencieux oval en acier inoxydable avec coloration noire réalisé avec traitement céramique pour hautes températures. Il est également disponible en version GHISA EVO, avec une sortie en carbone. Excellente qualité à des prix compétitifs. La version homologuée est munie d'un dB-killer amovible pour usage sur piste.

EN

GHISA line is our newest offering for the market! The word "Ghisa" is used as a slang term in Milan to mean traffic cop and when someone wants to warn another rider shouts "Ghisa! Close the gas!". So we have created Ghisa to be quiet with low rpm but to still have a great sound and good power when the revs climb and the gas is fully open. Made of stainless steel 304, the black colour finish is created with a ceramic treatment which improves heat resistance. GHISA EVO is provided of a carbon end cap. Homologated version is provided of a removable db-killer for racing use.



Ghisa Evo

Artículo bajo pedido, con plazo de entrega de 3 semanas.



GPE Inox Tiburón

Artículo bajo pedido, con plazo de entrega de 3 semanas.



ES

La Colección TIBURÓN nace de una evolución de la línea GPE y se caracteriza por una forma más elegante y deportiva. Tiburón, en versión poppy (símil carbono) o titanio, se monta principalmente a las motocicletas con el escape debajo del asiento y también para las motocicletas y scooter con escape lateral e incluso algún modelo de quad. Esta línea está disponible en versión homologada y con doble db killer.

FR

La collection TIBURON découle de l'évolution de la ligne GPE et se caractérise par une forme plus élégant et sportif. Tiburón est dédié spécialement pour les motos avec échappement underseat mais maintenant est également disponible pour les motos avec échappement latéraux. Le endtopa été changé dans le temps de façon à permettre l'utilisation d'un dB-killer amovible. La Collection TIBURON est disponible en les versions poppy et titane. La gamme homologuée est équipé de double db killer amovible pour usage sur piste.

EN

Tiburón line is a GPE special evolution, mostly dedicated to motorbikes with undertail exhausts but now available for lateral versions as well. Amazing shark look, offered in poppy or titanium finishing. This line is available both in racing and homologated set up. Homologated and catalytic options are offered with a dual removable dbkiller system unique on the market.



GPE Poppy Tiburón

Artículo bajo pedido, con plazo de entrega de 3 semanas.





GPE Evo Black Titanium

Artículo bajo pedido, con plazo de entrega de 3 semanas.



GPE Inox

Artículo bajo pedido, con plazo de entrega de 3 semanas.



GPE Poppy

Artículo bajo pedido, con plazo de entrega de 3 semanas.



GPE Titanio

Artículo bajo pedido, con plazo de entrega de 3 semanas.



ES

Colección GRAND PRIX EVOLUTION es la línea más longeva de nuestro catálogo. Nace también gracias a nuestra experiencia con la MOTOGP con la colaboración del equipo LCR Honda de Lucio Cecchinello con Casey Stoner como piloto. Lo más importante de la línea GPE EVO es el nuevo titanio pintado en negro con el tratamiento cerámico. Esta línea tiene entrada y la salida de doble fondo de ergal, con el cuerpo en titanio, titanio negro o poppy (símil carbono) tienen sección conical, que pasa de redondo a ovalado. Dispone además el doble db killer. Estas características hacen del GPE el silenciador más particular y moderno que hay actualmente en el mercado. Esta línea está disponibles en versión homologada para uso en carretera y con doble db killer extraíble.

FR

Le plus aimé parmi les collections GPR est la famille Furore, disponible en aluminium, noir et look carbone ou en version Albus, complètement blanche. Compact, léger, puissant et pas cher! Qu'est-ce que vous pourriez demander plus? Endcaps et entrée fabriqués en ergal avec CNC centre, ce genre de production accorder l'assemblage parfait et son incroyable! La nouveauté est le renouvellement de l'usinage pour la finition noir et Albus: pas plus dans la peinture simple, mais avec un nouveau traitement en céramique, afin d'accroître encore la qualité, avec traitement effectué sur la pièce finie et non sur les composants, avec une plus grande résistance à la lachaleur et de l'impact. Les versions homologués et catalysées sont équipée de double dbkiller amovible pour une utilisation sur piste.

EN

Furore and Albus line! Looking to these pipes you can understand why "style" in exhausts word means "GPR"! Compact, light, powerful and not expensive! What could you ask more? Endcaps and entrance made in ergal with CNC center, this kind of production grant perfect assembling and incredible sound! Albus and black finish are now realized with new ceramic treatment to improve heat resistance and durability. Furore line is available in homologated and racing options. Homologated and catalytic versions are offered with a dual removable dbkiller system unique on the market.



Fast Powercone

Artículo bajo pedido, con plazo de entrega de 3 semanas.



ES

La colección POWERCONE representa la línea más artesanal de nuestro catálogo. Disponible en acero inoxidable, la línea FAST CAN es especialmente indicada para motocicletas Super-Sport Naked, POWERCROSS. Es nuestra línea derivada para el mundo OFF-ROAD. Se puede adquirir en kit silencioso o línea completa. Fabricados en acero inoxidable, hecho a mano y con soldaduras TIG (Tungsten Inert Gas). Todos los escapes están disponibles en versión homologado para uso en carretera dispone de doble db killer extraíble.

FR

Collection POWERCONE représentent la production plus agressif dans notre catalogue 2016. Elle est disponible comme ligne FAST CAN, réservé uniquement à les principales motos supersport et naked, ou la ligne POWERCROSS dédié principalement au monde enduro et cross, tous deux faits en acier inoxydable et fabriquées à la main avec soudures TIG. Option homologué pour un usage routier avec double db killer amovible pour usage sur piste.

EN

FAST CAN line represent the best Italian quality production in GPR catalogue, availableas POWERCONE or POWERCROSS options. This range is dedicated to main supersport and naked motorbikes, products are stainless steel made with amazing tig welding and thanks to a thickness of 0,8mm only it remain really light and powerfull. Both types available in racing or homologated version. Homologated and catalytic options are offered with a dual removable dbkiller system unique on market.



Deeptone Inox

Artículo bajo pedido, con plazo de entrega de 3 semanas.



Deeptone Black

Artículo bajo pedido, con plazo de entrega de 3 semanas.



Deeptone Carbon

Artículo bajo pedido, con plazo de entrega de 3 semanas.



Power Cross

Artículo bajo pedido, con plazo de entrega de 3 semanas.





Pandemonium

Artículo bajo pedido, con plazo de entrega de 3 semanas.



ES

PANDEMONIUM es una de las mejores líneas del catálogo GPR. Desarrollada durante 2015 con la colaboración de nuestro equipo de SBK, esta gama está especialmente indicada para motocicletas SuperSport y Naked. Totalmente realizada en fibra de carbono es el sistema de escape homologado más ligero, tan sólo 1,5kgs de peso.

FR

Collection PANDEMONIUM représentent la meilleure production dans notre catalogue, développée pendant 2015 avec la collaboration de nos équipes de SBK. La gamme est réservée uniquement à les principales motos supersport et motos naked. Ce silencieux, réalisé complètement en carbone, est le système d'échappement homologué plus léger du marché avec seulement 1,5kg de poids.

EN

PANDEMONIUM is one of the high-end range GPR lines along with titanium versions. Pandemonium is realized in genuine carbon and it offers incredible weight saving and performance maximization. It has been developed during 2015 thanks to cooperation with SBK and STK team. Available in racing and homologated options for the most important naked and supersport bikes. Homologated and catalytic options are offered with a dual removable dbkiller system, unique on the market.



Inox Tondo

Artículo bajo pedido, con plazo de entrega de 3 semanas.



Trioval

Artículo bajo pedido, con plazo de entrega de 3 semanas.



Carbon Oval

Artículo bajo pedido, con plazo de entrega de 3 semanas.



Titanio Oval

Artículo bajo pedido, con plazo de entrega de 3 semanas.





Juntas de escape



Referencia	Ø Exterior	Ø Interior	Ancho
DAT02224	36,0	32,0	32,0

Referencia	Ø Exterior	Ø Interior	Ancho
DMC02208	31,4	25,5	27,7
DAT02207	34,7	28,7	25,2
DAT02225	34,6	28,7	28,2
DMC02213	34,6	28,8	25,5
DMC02227	37,4	31,6	30,8
DAT02209	37,5	31,7	26,7
DMC02221	38,7	31,7	25,0
DMC02211	37,2	32,0	25,0
DAT02229	37,0	32,2	26,2
DMX02156	48,5	34,1	23,5
DMC02228	41,6	34,8	30,1
DAT02228	41,0	35,0	25,0
DAT02222	41,2	35,0	26,0
DAT02230	41,2	35,2	31,3
DMC02232	44,6	38,0	28,3
DMX02150	48,6	38,0	34,5
DMX02153	44,0	38,0	31,0
DAT02227	44,3	38,3	24,5
DMC02205	44,5	38,4	25,0
DMC02217	43,5	38,5	27,6
DMX02151	48,6	40,7	35,3
DMC02210	48,5	42,7	20,6
DMC02235	48,7	42,7	29,0

Referencia	Ø Exterior	Ø Interior	Ancho
DMC02245	43,7	38,2	30,0
DMX02152	48,5	41,3	34,2
DAT02206	46,4	42,0	25,0
DMC02247	49,5	45,0	34,8
DMX02154	54,3	49,0	29,9
DSM02047	34,0	51,0	57,0

Referencia	Ø Exterior	Ø Interior	Ancho
DAT02235	32,7	28,7	30,5
DAT02231	36,3	31,7	30,7
DMC02218	38,6	35,0	25,3
DAT02234	46,8	42,2	25,5

HONDA	CULATA - COLECTOR				COLECTOR - SILENCIOSO		
	Año	Referencia Original	Referencia	€	Referencia Original	Referencia	€
NX 125	88-90	18291-MN5-650	DAT02220	2,50			
CRF 150 F	03-14	18291-MN5-650	DAT02220	2,50	18391-MB0-891	DMC02213	9,00
CRF 150 R	2005	18291-MN5-650	DAT02220	2,50			
CRF 150 R	06-14				18392-MK4-000	DMC02205	9,00
CRF 150 RB	06-14				18392-MK4-000	DMC02205	9,00
XR 200 R	84-85				18391-438-306	DMC02232	9,00
XR 200 R	88-00	18291-MN5-650	DAT02220	2,50	18391-MB0-891	DMC02213	9,00
XR 200 R	86-87				18391-MB0-891	DMC02213	9,00
CRF 230 F	03-14	18291-MN5-650	DAT02220	2,50	18391-MB0-891	DMC02213	9,00
CRF 230 L	08-09	18291-MN5-650	DAT02220	2,50	18391-ML8-000	DMC02211	9,00
CRF 250 R	07-09	18392-MK4-000	DMC02205	9,00	18391-ML8-000	DMC02211	9,00
CRF 250 R	10-14	18392-MK4-000	DMC02205	9,00			
CRF 250 X	04-13				18392-MK4-000	DMC02205	9,00
XL 250 R	84-87				18391-438-306	DMC02232	9,00
XL 250 S	84-86				18391-MB0-891	DMC02213	9,00
XL 250 S	78-81				18391-MB0-891	DMC02213	9,00
XR 250 L	92-96				18392-ML0-000	DMC02209	10,50
XR 250 R	81-82				18391-429-010	DMC02231	11,70
XR 250 R	84-85				18391-438-306	DMC02232	9,00
XR 250 R	86-89				18392-MK4-000	DMC02205	9,00
XR 350 R	83-84				18391-438-306	DMC02232	9,00
XL 350 R	84-85				18392-MK4-000	DMC02205	9,00
XR 400 R	96-97	18291-MN5-650	DAT02220	2,50			
XR 400 R	98-04	18291-MN5-650	DAT02220	2,50	18392-MK4-000	DMC02205	9,00
CRF 450 R	02-08				18392-MEB-670	DMX02156	9,00
CRF 450 R	09-12				18391-ML0-003	DMC02210	11,50
CRF 450 R (silen. izquierdo)	13-14	18391-ML0-003	DMC02210	11,50	18391-ML8-000	DMC02211	9,00
CRF 450 X	05-14				18392-MEB-670	DMX02156	9,00
XR 500 R	79-83				18391-429-010	DMC02231	11,70
XL 500	79-82				18391-429-010	DMC02231	11,70
XL 600 R	83-87				18391-429-010	DMC02231	11,70
XR 600 R	85-87	18291-MN5-650	DAT02220	2,50	18391-429-010	DMC02231	11,70
XR 600 R	88-90	18291-MN5-650	DAT02220	2,50	18391-MN1-670	DMC02213	9,00
XR 600 R	91-00	18291-MN5-650	DAT02220	2,50	18392-MJ4-670	DMC02235	9,00
XL 600 V Transalp	89-90	18291-MN4-920	DAT02219	2,50			
NX 650	88-89	18291-MN5-650	DAT02220	2,50			
XR 650 L	93-14	18291-MN5-650	DAT02220	2,50	18392-449-000	DMC02235	11,70
XR 650 R	00-07	18291-MN5-650	DAT02220	2,50	18392-MG7-750	DMC02207	10,00
XR 650 R (colector medio)	00-07	18391-MB0-891	DMC02213	9,00			

ADMISIÓN / ESCAPE / REFRIGERACIÓN



Referencia	Descripción	Precio
DMX02209	WR 450 F 2016 YZ 450 F 10-16	2,73



Referencia	Ø Exterior	Ø Interior	Ancho
DAT02213	44,7	38,6	5,3



Referencia	Ø Exterior	Ø Interior	Ancho
DAT02216	40,5	32,7	3,7
DAT02210	50,0	40,2	5,0



Referencia	Ø Exterior	Ø Interior	Ancho
DAT02221	54,3 / 44,2	38,6	10,4
DAT02208	56,1 / 48,3	41,7	10,2
DAT02223	58,1	42,6 / 43	14,0



Referencia	Ø Exterior	Ø Interior	Ancho
DAT02215	39,5	30,8	2,5
DAT02220	40,0	31,7	4,2
DAT02219	43,0	35,0	4,0
DAT02214	45,0	37,1	4,1
DAT02252	46,5	39,9	2,6



Referencia	Ø Exterior	Ø Interior	Ancho
DAT02211	32,7	22,4	4,1
DAT02212	42,4	31,9	3,4
DAT02217	42,0	35,3	5,5
DAT02218	43,0	34,5	5,0
X1387881	49,5	39,0	5,4
X1387885	42,2	31,8	3,6

KAWASAKI	Año	CULATA - COLECTOR			COLECTOR - SILENCIOSO		
		Referencia Original	Referencia	€	Referencia Original	Referencia	€
KL 250	90-05				11009-1667	DAT02222	9,00
KL 250	09-10				11061-0360	DMC02211	9,00
KLR 250	90-05				11009-1667	DAT02222	9,00
KLX 250	94-96				11060-1068	DMC02205	9,00
KLX 250	06-14				11061-1055	DMC02216	9,00
KLX 300 R	97-07				11060-1068	DMC02205	9,00
KL 600	84-86				11009-1666	DMC02215	11,70
KL 650 Tengai	90-91				11009-1666	DMC02215	11,70
KLR 650	87-10				11009-1666	DMC02215	11,70
KLX 650	93-96				11009-1666	DMC02215	11,70
SUZUKI	Año	CULATA - COLECTOR			COLECTOR - SILENCIOSO		
		Referencia Original	Referencia	€	Referencia Original	Referencia	€
DR-Z 250	01-07				14771-13E00	DMC02218	7,50
RM-Z 250	10-13				14771-45G00	DAT02206	13,60
DR 350	90-99				14771-13E00	DMC02218	7,50
RMX 450 Z	10-11				14181-35G00	DAT02252	2,50
RM-Z 450	05-13				14181-35G00	DAT02252	2,50
YAMAHA	Año	CULATA - COLECTOR			COLECTOR - SILENCIOSO		
		Referencia Original	Referencia	€	Referencia Original	Referencia	€
TW 200	02-14				3YF-14714-00	DMC02227	9,00
XT 225	92-07				3YF-14714-00	DMC02227	9,00
TT-R 225	99-03				3YF-14714-00	DMC02227	9,00
TT-R 225	05-06				4EL-14714-00	DMC02228	10,30
TT-R 230	05-14				3YF-14714-00	DMC02227	9,00
TT-R 250	99-06				4EL-14714-00	DMC02228	9,00
WR 250 F	01-13				5PH-14714-00	DMX02150	10,30
WR 250 R (colector medio)	08-14	5PX-14755-00	DMC02245	12,00			
WR 250 X (colector medio)	08-14	5PX-14755-00	DMC02245	12,00			
YZ 250 F	01-05				3VD-14755-00	DMC02232	9,00
YZ 250 F	06-13				5XD-14714-00	DMX02152	10,30
YZ 250 F (colector medio)	2014	5PX-14755-00	DMC02245	12,00	1SL-14714-00	DMX02154	11,70
XT 250	98-14				3YF-14714-00	DMC02227	9,00
XT 350	92-00				4EL-14714-00	DMC02228	10,30
WR 400 F	98-00				3GW-14714-00	DMX02151	13,60
YZ 400 F	98-99				3GW-14714-00	DMX02151	13,60
WR 426 F	01-02				3GW-14714-00	DMX02151	13,60
WR 450 F	2003				3GW-14714-00	DMX02151	13,60
WR 450 F	07-11				5PH-14714-00	DMX02150	9,00
WR 450 F	12-14				5XD-14714-00	DMX02152	10,30
YZ 426 F	00-02				3GW-14714-00	DMX02151	13,60
YZ 450 F	2003				3GW-14714-00	DMX02151	13,60
YZ 450 F	04-06				5XD-14714-00	DMX02152	10,30
YZ 450 F	07-09				5VY-14714-00	DMC02247	13,60
YZ 450 F (colector medio)	10-13	5PH-14714-00	DMX02150	9,00	8GL-14714-00	DSM02047	13,60
YZ 450 F (colector medio)	14-15	5XD-14714-00	DMX02152	10,30	1SL-14714-00	DMX02154	11,70
TT 600	83-86				3YF-14755-00	DAT02206	13,60
XT 600	84-95				3YF-14755-00	DAT02206	13,60

RUEDAS Y NEUMÁTICOS
MOTOR
ADMISIÓN / ESCAPE REFRIGERACIÓN
ELECTRICO
SUSPENSIÓN / DIRECCIÓN
FRENS
TRANSMISIÓN
CONTROLES Y MANDOS
CHASIS
ACCESORIOS

ADMISIÓN / ESCAPE / REFRIGERACIÓN



Radiadores

Radiador estándar o sobredimensionado.
Se comercializa el kit completo o por radiador suelto.
Se monta sobre anclaje original.
Soldadura del aluminio en TIG.



* Referencias con asterisco indica en qué lado se encuentra el tapón de relleno de anticongelante.

** DXD10019 Sin ubicación para anclaje de ventilador ni termostato.

			COMPLETO		IZQUIERDO		DERECHO	
GAS GAS	Año	Descripción	Referencia	€	Referencia	€	Referencia	€
EC 200	98-06	Estándar	DXD10085	192	DXD10085L	110	DXD10085R	110
EC 200	07-11	Estándar	DXD10086	192	DXD10086L	110	DXD10086R	110
MC 200	98-06	Estándar	DXD10085	192	DXD10085L	110	DXD10085R	110
MC 200	07-11	Estándar	DXD10086	192	DXD10086L	110	DXD10086R	110
EC 250	98-06	Estándar	DXD10085	192	DXD10085L	110	DXD10085R	110
EC 250	07-11	Estándar	DXD10086	192	DXD10086L	110	DXD10086R	110
MC 250	98-06	Estándar	DXD10085	192	DXD10085L	110	DXD10085R	110
MC 250	07-11	Estándar	DXD10086	192	DXD10086L	110	DXD10086R	110
EC 300	98-06	Estándar	DXD10085	192	DXD10085L	110	DXD10085R	110
EC 300	07-11	Estándar	DXD10086	192	DXD10086L	110	DXD10086R	110
MC 300	98-06	Estándar	DXD10085	192	DXD10085L	110	DXD10085R	110
MC 300	07-11	Estándar	DXD10086	192	DXD10086L	110	DXD10086R	110

			COMPLETO		IZQUIERDO		DERECHO	
HONDA	Año	Descripción	Referencia	€	Referencia	€	Referencia	€
CR 85 R	97-08	Sobredimensionado	DXD10008	110				
CR 125	02-04	Estándar	DXD10025	192	DXD10025L	110	DXD10025R*	110
CR 125	05-07	Estándar	DXD10026	192	DXD10026L	110	DXD10026R*	110
CRF 150 R	07-17	Sobredimensionado	DXD10009	192	DXD10009L	110	DXD10009R*	110
CR 250 R	02-04	Estándar	DXD10027	192	DXD10027L	110	DXD10027R*	110
CR 250 R	05-07	Estándar	DXD10028	192	DXD10028L	110	DXD10028R*	110
CRF 250 R	04-09	Sobredimensionado	DXD10000	192	DXD10000L	110	DXD10000R*	110
CRF 250 R	10-13	Estándar	DXD10029	192	DXD10029L	110	DXD10029R*	110
CRF 250 X	04-16	Sobredimensionado	DXD10000	192	DXD10000L	110	DXD10000R*	110
CRF 450 R	02-04	Sobredimensionado	DXD10012	192	DXD10012L	110	DXD10012R*	110
CRF 450 R	05-08	Sobredimensionado	DXD10001	192	DXD10001L	110	DXD10001R*	110
CRF 450 R	09-12	Estándar	DXD10030	192	DXD10030L	110	DXD10030R*	110
CRF 450 R	13-14	Sobredimensionado	DXD10074	192	DXD10074L	110	DXD10074R*	110
CRF 450 R	15-16	Estándar	DXD10087	192	DXD10087L	110	DXD10087R*	110
CRF 450 X	05-16	Estándar	DXD10056	192	DXD10056L	110	DXD10056R*	110
XR 650 R	00-07	Estándar	DXD10043	192	DXD10043L	110	DXD10043R*	110

			COMPLETO		IZQUIERDO		DERECHO	
HUSABERG	Año	Descripción	Referencia	€	Referencia	€	Referencia	€
FE 250	13-14	Estándar	DXD10020	192	DXD10020L	110	DXD10020R*	110
TE 250	11-13	Estándar	DXD10021	192	DXD10021L	110	DXD10021R*	110
TE 300	11-13	Estándar	DXD10021	192	DXD10021L	110	DXD10021R*	110
FE 350	2013	Estándar	DXD10020	192	DXD10020L	110	DXD10020R*	110
FE 390	10-11	Estándar	DXD10020	192	DXD10020L	110	DXD10020R*	110
FE 450	09-11	Estándar	DXD10020	192	DXD10020L	110	DXD10020R*	110
FE 501	13-14	Estándar	DXD10020	192	DXD10020L	110	DXD10020R*	110

			COMPLETO		IZQUIERDO		DERECHO	
HUSQVARNA	Año	Descripción	Referencia	€	Referencia	€	Referencia	€
CR 125	00-08	Sobredimensionado	DXD10057	192	DXD10057L	110	DXD10057R	110
WR 125	00-08	Sobredimensionado	DXD10057	192	DXD10057L	110	DXD10057R	110
CR 250	00-05	Sobredimensionado	DXD10057	192	DXD10057L	110	DXD10057R	110
WR 250	00-10	Sobredimensionado	DXD10057	192	DXD10057L	110	DXD10057R	110
WR 300	09-10	Sobredimensionado	DXD10057	192	DXD10057L	110	DXD10057R	110
WR 360	00-02	Sobredimensionado	DXD10057	192	DXD10057L	110	DXD10057R	110

ADMISIÓN / ESCAPE / REFRIGERACIÓN



Radiadores

KAWASAKI	Año	Descripción	COMPLETO		IZQUIERDO		DERECHO	
			Referencia	€	Referencia	€	Referencia	€
KX 80	2000	Sobredimensionado	DXD10015	110				
KX 85	01-13	Sobredimensionado	DXD10015	110				
KX 85	14-17	Estándar	DXD10088	110				
KX 100	98-13	Sobredimensionado	DXD10015	110				
KX 100	14-17	Estándar	DXD10088	110				
KX 125	94-02	Estándar	DXD10041	192	DXD10041L	110	DXD10041R*	110
KDX 200	97-06	Estándar	DXD10061	192	DXD10061L	110	DXD10061R*	110
KX 250	94-02	Estándar	DXD10041	192	DXD10041L	110	DXD10041R*	110
KX 250 F	04-05	Sobredimensionado	DXD10011	192	DXD10011L	110	DXD10011R*	110
KX 250 F	2006	Sobredimensionado	DXD10006	192	DXD10006L	110	DXD10006R*	110
KX 250 F	2009	Estándar	DXD10023	192	DXD10023L	110	DXD10023R*	110
KX 250 F	11-16	Estándar	DXD10084	192	DXD10084L	110	DXD10084R	110
KX 450 F	06-07	Sobredimensionado	DXD10004	192	DXD10004L	110	DXD10004R*	110
KX 450 F	2008	Sobredimensionado	DXD10016	192	DXD10016L	110	DXD10016R*	110
KX 450 F	12-15	Estándar	DXD10091	192	DXD10091L	110	DXD10091R	110
KLX 450	08-09	Sobredimensionado	DXD10016	192	DXD10016L	110	DXD10016R*	110

KTM	Año	Descripción	COMPLETO		IZQUIERDO		DERECHO	
			Referencia	€	Referencia	€	Referencia	€
85 SX	03-10	Estándar	DXD10042	192	DXD10042L*	110	DXD10042R	110
85 SX	13-16	Estándar	DXD10079	192	DXD10079L*	110	DXD10079R	110
105 SX	03-10	Estándar	DXD10042	192	DXD10042L*	110	DXD10042R	110
125 EXC	98-06	Estándar	DXD10083	192	DXD10083L*	110	DXD10083R	110
125 SX	08-13	Estándar	DXD10021	192	DXD10021L	110	DXD10021R*	110
125 SX	98-06	Estándar	DXD10083	192	DXD10083L*	110	DXD10083R	110
144 XS	2008	Estándar	DXD10021	192	DXD10021L	110	DXD10021R*	110
144 SX	98-06	Estándar	DXD10083	192	DXD10083L*	110	DXD10083R	110
150 SX	09-13	Estándar	DXD10021	192	DXD10021L	110	DXD10021R*	110
150 SX	98-08	Estándar	DXD10083	192	DXD10083L*	110	DXD10083R	110
150 XC	10-13	Estándar	DXD10021	192	DXD10021L	110	DXD10021R*	110
200 XC-W	09-13	Estándar	DXD10021	192	DXD10021L	110	DXD10021R*	110
250 EXC	00-05	Estándar	DXD10055	192	DXD10055L*	110	DXD10055R	110
250 Freerider	14-15	Estándar	DXD10082	192				
250 SX	00-05	Estándar	DXD10055	192	DXD10055L*	110	DXD10055R	110
250 SX	08-13	Estándar	DXD10021	192	DXD10021L	110	DXD10021R*	110
250 SX-F	07-12	Estándar	DXD10019	192	DXD10019L	110	DXD10019R*	110
250 SX-F	12-15	Estándar	DXD10019	192	DXD10019L	110	DXD10019R*	110
250 SXS-F	2007	Estándar	DXD10019	192	DXD10019L	110	DXD10019R*	110
250 XC-F	08-09	Estándar	DXD10019	192	DXD10019L	110	DXD10019R*	110
250 XC-F	11-12	Estándar	DXD10019	192	DXD10019L	110	DXD10019R*	110
250 XC-W	08-13	Estándar	DXD10021	192	DXD10021L	110	DXD10021R*	110
300 XC	09-13	Estándar	DXD10021	192	DXD10021L	110	DXD10021R*	110
300 XC-W	09-13	Estándar	DXD10021	192	DXD10021L	110	DXD10021R*	110
350 EXC-F	12-14	Estándar	DXD10019	192	DXD10019L	110	DXD10019R*	110
350 SX-F	11-12	Estándar	DXD10019	192	DXD10019L	110	DXD10019R*	110
350 XC-F	11-12	Estándar	DXD10019	192	DXD10019L	110	DXD10019R*	110
350 XCF-W	11-14	Estándar	DXD10019	192	DXD10019L	110	DXD10019R*	110
400 EXC	00-02	Estándar	DXD10055	192	DXD10055L*	110	DXD10055R	110
400 EXC	03-07	Estándar	DXD10040	192	DXD10040L*	110	DXD10040R	110
400 EXC	09-11	Estándar	DXD10019	192	DXD10019L	110	DXD10019R*	110
400 SX	00-02	Estándar	DXD10055	192	DXD10055L*	110	DXD10055R	110
400 SX	03-07	Estándar	DXD10040	192	DXD10040L*	110	DXD10040R	110
400 XC-W	2007	Estándar	DXD10040	192	DXD10040L*	110	DXD10040R	110
400 XC-W	09-10	Estándar	DXD10020	192	DXD10020L	110	DXD10020R*	110
450 EXC	00-02	Estándar	DXD10055	192	DXD10055L*	110	DXD10055R	110
450 EXC	03-07	Estándar	DXD10040	192	DXD10040L*	110	DXD10040R	110
450 EXC	08-12	Estándar	DXD10019	192	DXD10019L	110	DXD10019R*	110
450 EXC-R	09-10	Estándar	DXD10020	192	DXD10020L	110	DXD10020R*	110
450 SX	00-02	Estándar	DXD10055	192	DXD10055L*	110	DXD10055R	110
450 SX	03-07	Estándar	DXD10040	192	DXD10040L*	110	DXD10040R	110
450 SMR	08-09	Estándar	DXD10019	192	DXD10019L	110	DXD10019R*	110
450 SMR	08-12	Estándar	DXD10020	192	DXD10020L	110	DXD10020R*	110
450 SX-F	07-08	Estándar	DXD10019	192	DXD10019L	110	DXD10019R*	110
450 SX-F	09-11	Estándar	DXD10020	192	DXD10020L	110	DXD10020R*	110
450 SX-F	13-14	Estándar	DXD10019	192	DXD10019L	110	DXD10019R*	110
450 SXS-F	12-15	Estándar	DXD10019	192	DXD10019L	110	DXD10019R*	110

RUEDAS Y NEUMÁTICOS
MOTOR
ADMISIÓN / ESCAPE REFRIGERACIÓN
ELECTRICO
SUSPENSIÓN / DIRECCIÓN
FRENS
TRANSMISIÓN
CONTROLES Y MANDOS
CHASIS
ACCESORIOS



Radiadores

			COMPLETO		IZQUIERDO		DERECHO	
450 XC-F	06-07	Estándar	DXD10040	192	DXD10040L*	110	DXD10040R	110
450 XC-F	08-15	Estándar	DXD10019	192	DXD10019L	110	DXD10019R*	110
450 XC-W	06-07	Estándar	DXD10040	192	DXD10040L*	110	DXD10040R	110
450 XC-W	08-15	Estándar	DXD10019	192	DXD10019L	110	DXD10019R*	110
500 EXC	2015	Estándar	DXD10019	192	DXD10019L	110	DXD10019R*	110
500 XC-W	2015	Estándar	DXD10019	192	DXD10019L	110	DXD10019R*	110
505 SX-F	2008	Estándar	DXD10019	192	DXD10019L	110	DXD10019R*	110
505 SX-F	09-11	Estándar	DXD10020	192	DXD10020L	110	DXD10020R*	110
505 XC-F	08-09	Estándar	DXD10019	192	DXD10019L	110	DXD10019R*	110
520 EXC	00-02	Estándar	DXD10055	192	DXD10055L*	110	DXD10055R	110
520 SX	00-02	Estándar	DXD10055	192	DXD10055L*	110	DXD10055R	110
525 EXC	03-07	Estándar	DXD10040	192	DXD10040L*	110	DXD10040R	110
525 SX	03-07	Estándar	DXD10040	192	DXD10040L*	110	DXD10040R	110

			COMPLETO		IZQUIERDO		DERECHO	
SUZUKI	Año	Descripción	Referencia	€	Referencia	€	Referencia	€
RM 85	02-16	Sobredimensionado	DXD10036	192	DXD10036L	110	DXD10036R*	110
RM 125	01-06	Estándar	DXD10076	192	DXD10076L	110	DXD10076R*	110
RM 250	01-08	Estándar	DXD10077	192	DXD10077L	110	DXD10077R*	110
RM-Z 250	04-06	Sobredimensionado	DXD10011	192	DXD10011L	110	DXD10011R*	110
RM-Z 250	07-09	Sobredimensionado	DXD10037	192	DXD10037L	110	DXD10037R*	110
RM-Z 250	10-12	Estándar	DXD10078	192	DXD10078L	110	DXD10078R*	110
RM-Z 450	2005	Estándar	DXD10018	192	DXD10018L	110	DXD10018R*	110
RM-Z 450	2006	Sobredimensionado	DXD10038	192	DXD10038L	110	DXD10038R*	110
RM-Z 450	2007	Sobredimensionado	DXD10039	192	DXD10039L	110	DXD10039R*	110
RM-Z 450	08-16	Estándar	DXD10045	192	DXD10045L	110	DXD10045R*	110
RM-Z 450	08-16	Sobredimensionado	DXD10089	192	DXD10089L	110	DXD10089R*	110
RMX 450	2010	Estándar	DXD10045	192	DXD10045L	110	DXD10045R*	110

			COMPLETO		IZQUIERDO		DERECHO	
YAMAHA	Año	Descripción	Referencia	€	Referencia	€	Referencia	€
YZ 85	02-17	Estándar	DXD10010	110				
YZ 125	05-17	Sobredimensionado	DXD10031	192	DXD10031L	110	DXD10031R*	110
WR 250 F	01-05	Sobredimensionado	DXD10005	192	DXD10005L	110	DXD10005R*	110
WR 250 F	07-13	Sobredimensionado	DXD10003	192	DXD10003L	110	DXD10003R*	110
YZ 250	97-01	Estándar	DXD10032	192	DXD10032L	110	DXD10032R*	110
YZ 250	02-17	Estándar	DXD10033	192	DXD10033L	110	DXD10033R*	110
YZ 250 F	01-05	Sobredimensionado	DXD10005	192	DXD10005L	110	DXD10005R*	110
YZ 250 F	2006	Sobredimensionado	DXD10003	192	DXD10003L	110	DXD10003R*	110
YZ 250 F	07-09	Sobredimensionado	DXD10007	192	DXD10007L	110	DXD10007R*	110
YZ 250 F	10-13	Estándar	DXD10034	192	DXD10034L	110	DXD10034R*	110
YZ 250 F	14-17	Estándar	DXD10090	192	DXD10090L	110	DXD10090R*	110
YZ 426 F	00-05	Sobredimensionado	DXD10014	192	DXD10014L	110	DXD10014R*	110
WR 426 F	00-05	Sobredimensionado	DXD10014	192	DXD10014L	110	DXD10014R*	110
WR 450 F	00-06	Sobredimensionado	DXD10014	192	DXD10014L	110	DXD10014R*	110
YZ 450 F	00-05	Sobredimensionado	DXD10014	192	DXD10014L	110	DXD10014R*	110
YZ 450 F	2006	Sobredimensionado	DXD10002	192	DXD10002L	110	DXD10002R*	110
YZ 450 F	07-09	Sobredimensionado	DXD10017	192	DXD10017L	110	DXD10017R*	110
YZ 450 F	10-13	Estándar	DXD10035	192	DXD10035L	110	DXD10035R*	110
YZ 450 F	14-17	Estándar	DXD10090	192	DXD10090L	110	DXD10090R*	110

Difusor temperatura radiador

Ø Interior 13,5mm Ø Exterior 18,8mm

Referencia	€
R160010	11,85



Rejas protección radiador

Dimensiones 20x30cm.
Fabricadas en aluminio.

	Referencia	€
PLATEADA	DMP12081S	6,44
NEGRA	DMP12081	6,44

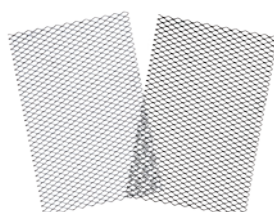

ELÉCTRICO



BRONCO Baterías

Todas las baterías Bronco llevan el ácido incluido. Las baterías sin mantenimiento o las baterías secas sólo se pueden recargar con cargadores de impulsos o de baja intensidad de carga.



APRILIA	Año	Referencia
450 MXV	06-12	YTX7A-BS
450 RXV	05-09	YTZ10S
450 RXV	10-	YTX7A-BS
450 SXV	05-10	YTZ10S
450 SXV	10-	YTX7A-BS
550 RXV	05-09	YTZ10S
550 RXV	10-	YTX7A-BS
550 SXV	05-09	YTZ10S
550 SXV	10-	YTX7A-BS

BETA	Año	Referencia
250 RR 2t Enduro	12-15	YTZ7S
300 RR 2t Enduro	13-15	YTZ7S
350 RR 4t Enduro	11-15	YTZ7S
350 RR Efi	15-	YTZ7S
390 RR 4t	15-	YTZ7S
400 RR 4t Enduro	05-15	YTZ7S
430 RR 4t	15-	YTZ7S
450 RR 4t Enduro	05-15	YTZ7S
498 RR 4t Enduro	12-15	YTZ7S
525 RR 4t	05-11	YTZ7S

BMW	Año	Referencia
G 450 X	08-11	YTZ7S

GAS-GAS	Año	Referencia
EC 250 F	10-15	YTZ7S
EC 250 FSE 4t	01-09	YTZ7S
EC 250 Racing	09-12	YTZ7S
EC 300 E	11-15	YTZ7S
EC 300 F	15-	YTZ7S
EC 300 Racing	09-15	YTZ7S
EC 300 Six Days	11-15	YTZ7S
EC 400 FSE	01-05	YTZ7S
EC 450 F	15-	YTZ7S
RC 450 Raid	15-	YTZ7S

HM	Año	Referencia
CRE 250 X	09-15	YTZ7S
CRE F 300 X	08-09	YTZ7S
CRE 450 X	09-15	YTZ7S

HONDA	Año	Referencia
CRF 230 F	03-13	YTZ7S
CRF 250 L	08-13	YTZ7S
CRF 250 M	13-	YTX7L-BS
CRF 250 X	04-13	YTZ7S
CRF 450 F	01-15	YTZ7S
CRF 450 Rally	13-15	YTZ7S
CRF 450 X	05-09	YTZ7S
XR 250 R	03-10	YTX7L-BS
XR 600 R	93-93	YTX9-BS
XR 650 L	93-11	YTX9-BS
XR 650 R	00-07	YTX9-BS

HUSABERG	Año	Referencia
350 FE	13-14	YTZ7S
390 FE	10-12	YTZ7S
450 FC	04-11	YTZ7S
450 FE	04-13	YTZ7S
450 FS	04-04	YTZ7S
450 FX	10-13	YTZ7S
501 FE	13-14	YTZ7S
550 FC	06-08	YTZ7S
550 FE	06-08	YTZ7S

HUSQVARNA	Año	Referencia
250 FE	14-15	YTZ7S
250 TC	04-14	YTZ7S
250 TE	05-14	YTZ7S
250 TE-R	13-13	YTZ7S
310 TE	09-13	YTZ7S
310 TE-R	13-13	YTZ7S
410 TE	95-00	YTZ7S
410 TE/E	00-02	YTZ7S
449 TC	11-13	YTZ7S
449 TE	11-13	YTZ7S
450 FC	14-15	YTZ7S
450 SM R	01-04	YTZ7S
450 TC	05-10	YTZ7S
450 TE	05-10	YTZ7S
501 FE	14-15	YTZ7S
510 TC	04-09	YTZ7S
510 TE	95-10	YTZ7S
511 TE	11-13	YTZ7S
570 SM R	01-04	YTZ7S
610 SM R	00-04	YTZ7S
610 TC	95-03	YTZ7S
610 TE	92-03	YTZ7S
630 SM R	06-12	YTZ7S
630 TE	10-12	YTZ7S

KAWASAKI	Año	Referencia
KLX 250 S	05-15	YTX7L-BS
KLX 400 R	03-04	YT7B-BS
KLX 450 R	07-15	YTZ7S

KTM	Año	Referencia
250 EXC 4t	03-05	YTZ7S
250 EXC 2t	05-	YTX4L-BS
250 EXC 2t Six Days	05-	YTX4L-BS
250 EXC-F	05-	YTX5L-BS
250 EXC-F Six Days	05-	YTX4L-BS
250 SX-F	05-	YTX4L-BS
250 XC	05-	YTX4L-BS
250 XC-F	05-	YTX4L-BS
300 EXC	05-	YTX4L-BS
300 EXC Six Days	05-	YTX4L-BS
300 XC	05-	YTX4L-BS
450 EXC	04-14	YTX5L-BS
450 MXC Racing	00-02	YTX5L-BS
450 SXF	07-14	YTX4L-BS
450 XC F	06-14	YTX5L-BS
450 XC W	05-	YTX5L-BS
500 EXC 4t	12-14	YTX5L-BS
500 EXC Six Days	12-14	YTX5L-BS
505 SXF	07-09	YTX5L-BS
525 EXC	03-16	YTZ5S
525 EXC/SX	04-05	YTZ5S
530 EXC-R/XC/W	08-11	YTX5L-BS

SHERCO	Año	Referencia
250 SEF	15-	YTX5L-BS
250 SE-R	15-	YTX5L-BS
250 SEF-R	15-	YTX5L-BS
SX 2.5 F	10-11	YTX5L-BS
SE 2.5 i	12-14	YTX5L-BS
X-Ride 290	13-14	YTX5L-BS
SE 3.0	10-11	YTX5L-BS
SE 3.0 i	12-14	YTX5L-BS
300 SE	15-	YTX5L-BS
300 SEF	15-	YTX5L-BS
300 SE-R	15-	YTX5L-BS
300 SEF-R	15-	YTX5L-BS
SE 4.5 i	12-14	YTX5L-BS
4.5 4t	04-08	YTX5L-BS
450 SEF	15-	YTX5L-BS
450 SEF-R	15-	YTX5L-BS
5.1 4t	06-08	YTX5L-BS
SE 5.1 i	12-14	YTX5L-BS

SUZUKI	Año	Referencia
DR-Z 250	01-07	YTZ7S
DR-Z 400	00-13	YT7B-BS
RMX 450 Z	10-15	YT7B-BS

YAMAHA	Año	Referencia
WR 250 F	03-09	YTZ7S
WR 250 R	08-12	YTZ7S
WR 250 X	08-12	YTZ7S
WR 450 F	03-15	YTZ7S

Modelo	BRONCO		XPEED		BC Lítio	
	Referencia	€	Referencia	€	Referencia	€
YTX4L-BS	YTX4L-BS	18,59			BCTX5L	64,95
YTZ5S					BCTX5L	64,95
YTX5L-BS	YTX5L-BS	22,87			BCTX5L	64,95
YTX7A-BS	YTX7A-BS	29,14			BCTX9	89,95
YTX7L-BS	YTX7L-BS	29,14	X02070	26,90	BCTX7L	84,95
YT7B	YT7B-BS	37,99	X02072	33,92	BCT12B	139,95
YTZ7S	YTZ7S-BS	35,62			BCTX7L	84,95
YTX9-BS	YTX9-BS	36,10			BCTX9	89,95
YTZ10S	YTZ10S-BS	43,83			BCTZ10S	129,95



BC Baterías Lítio LiFeP04

Baterías Ultra Ligeras, equivale a un 80% mes peso de una batería de ácido-plomo Alta Potencia, alta corriente en arrancada, hasta 50 intentos a máxima potencia (5 en ácido-plomo) Larga Vida, aproximadamente 2000 ciclos de carga (400 las de ácido-plomo) Descarga lenta y rápida carga, con la batería almacenada la descarga es 2% mensual (un 12% ácido-plomo) Garantía de peligrosidad, no es inflamable, no es explosiva, sin riesgos de acidos. Respeta el medio ambiente, no utiliza ácidos, metales pesados, mercurio, cadmio ...

Referencia	Equivalencia	Dimensiones	Peso	CCA	€
BCTX5L	YTX4L-BS YTX5L-BS YTZ5S	113x70x85	0,5 Kg.	105	64,95 €
BCTX7L	YTX7L-BS YTZ7S	113x70x85	0,6 Kg.	160	84,95 €
BCTX9	YTX7A-BS YTX9-BS YTR9-BS	150x87x105	0,8 Kg.	180	89,95 €
BCTZ10S	YTZ10S YTX12-BS YTX12A-BS YB12B-B2	150x87x93	0,8 Kg.	240	129,95 €
BCT12B	YT7B-BS YT9B-BS YT12B-BS YT14B-BS YB16AL-A2	150x65x92	0,8 Kg.	290	139,95 €
BCTX14H	YTX14H-BS KMX14-BS YTX14-BS HVT-B	150x87x93	0,9 Kg.	240	129,95 €
BCTZ14S	YTZ12S YTZ14S YTX14H-BS KMX14-BS YTX14-BS HVT-8	150x87x93	0,9 Kg.	290	149,95 €
BCTZ20HL	YTX20HL-BS YTX24HL-BS YTX15L-BS YTX18L-BS YTX20L-BS YB16HL-A-CX Y50-N18L-A-CX YB16L-B YB16L-A2 YB16VL-B YB18L-A YB18L-A2 Y50-N18L-A Y50N18L-A2	175x87x130	1,2 Kg.	420	229,95 €
BC51913	51814 51913 52015 HG-18-12	181x77x170	1,7 Kg.	450	209,95 €
BCTX30	YIX30L YIX30L-BS Y60N24-A Y60N24AL-B YB30L-B YB30CL-B 52515 53030 53034 YHD-12H HVT-2 HVT-7	167x124x168	2,0 Kg.	540	249,95 €

RUEDAS Y NEUMÁTICOS

MOTOR

ADMISIÓN / ESCAPE
REFRIGERACIÓN

ELECTRICO

SUSPENSIÓN / DIRECCIÓN

FRENOS

TRANSMISIÓN

CONTROLES Y MANDOS

CHASIS

ACCESORIOS



Booster K1200

€
119,50

Ref. BCK1200



BC BOOSTER K1200

Arrancador para coche y moto.

Potente, ligero y de bolsillo.

Batería portátil de emergencia para SmartPhone y Tablets.

Tecnología LiFePO4 100% segura.

Se puede usar para recargar / alimentar dispositivos electrónicos por USB.

Puerto USB incorporado (5V, 2A).

Linterna de emergencia con luz fija o intermitente, con programa de socorro SOS.

El paquete incluye un juego de adaptadores para los principales modelos y marcas de SmartPhones.

FICHA TÉCNICA

DIMENSIONES	160 x 75 x 28 mm
PESO	380 gr
SALIDA	5V.....2A / 12V.....10A
ENTRADA	12V.....1A
CORRIENTE DE ARRANQUE (CA)	200A
CORRIENTE DE PICO (CP)	400A

BC Cargadores baterías



Referencia €
BC900 48,25

BC JUNIOR 900

BC Junior 900 es el cargador de baterías ideal para la recuperación, la carga, la desulfatación y el mantenimiento de todas las baterías de 12V de motocicletas y quads. El dispositivo está diseñado para permanecer siempre conectado a la batería y sin necesidad de desconectarla del vehículo. Recupera baterías profundamente descargadas a partir de una tensión de 1,25 Voltios.

FICHA TÉCNICA	BC JUNIOR 900
Tensión de carga	13,8 V / 14,4 V -nominal 12 V
Corriente de carga	0,9 A máx
Capacidad de batería	1,2 Ah a 100 Ah
Temperatura de funcionamiento	-20º a +50ºC



Referencia €
BCK900 63,25

BC K900 Edge 6V/12V/12V CAN-BUS

BC K900 edge es el cargador, mantenedor y recuperador de baterías más moderno e innovador del mercado. El cargador es ideal para todas las baterías 6/12V (tradicionales con electrolito líquido y tapones removibles, MF, GEL, AGM, VRLA), con función de recarga directa a través de las salidas de 12 V instaladas en vehículos equipados con CAN-Bus (por ejemplo: motos BMW). Recuperación a partir de 1,25 Voltios. Con BC K900 edge se puede elegir entre tres programas específicos : para baterías de 6 voltios, para baterías de 12 voltios y para recargar la batería directamente a través de la toma de 12 voltios de motos equipadas con sistema CAN-Bus. El revolucionario sistema de conexión directa BC KEY-LESS le permite conectarse directamente a la toma de 12V DIN 4165 (instalada en las motocicletas BMW), sin tener que girar la llave y encender el panel de instrumentos.

FICHA TÉCNICA	BC K900 edge
Tensión de carga	6,9V / 7,2 V -nominal 6 V - 13,8 V / 14,4 V -nominal 12 V
Corriente de carga	1 A máx.
Tipos de baterías	6/12 V de plomo-ácido (de gel, húmedas, MF, AGM, VRLA, Ca/Ca)
Capacidad de batería	De 1,2 Ah a 100 Ah
Temperatura de funcionamiento	-20º a +50ºC



Referencia €
BCDUE 70,86

BC DUETTO

BC DUETTO es el cargador inteligente universal para baterías desarrollado para proveer un único dispositivo multiuso para todas las baterías de moto de 12V. El cargador tiene dos programas de carga diferentes para baterías plomo-ácido y LiFePO4. Su corriente de carga (máx. 1,5 Amp) lo hace ideal no solo para la recuperación, la carga y el mantenimiento de todas las baterías de 12V de motocicletas, ciclomotores y quads, sino también para el mantenimiento de las baterías de coche. Recupera baterías profundamente descargadas a partir de una tensión de 1,25 Voltios La seguridad está garantizada en todas las etapas de la carga: en caso de bajas temperaturas detectadas por el sensor integrado, se activa el modo POLAR. BC DUETTO no produce chispas y está protegido contra cortocircuitos, inversiones de polaridad, sobrecarga y sobrecalentamiento.

FICHA TÉCNICA	BC DUETTO
Tensión de carga	13,8 V / 14,4 V - nominal 12 V -
Corriente de carga	1,5 A máx.
Tipos de baterías	12 V de plomo-ácido (de gel, abiertas, MF, AGM, VRLA, Ca/Ca...) & 12V LiFePO4
Capacidad de batería - Plomo-ácido	3 Ah a 70 Ah (Carga), hasta 100 Ah (Mantenimiento)
Capacidad de batería -LiFePO4	1 Ah a 100 Ah
Temperatura de funcionamiento	-20º a +50ºC



Referencia €
BC3500 82,23

BC 3500 EVO

BC 3500 EVO es el nuevo producto de la gama BC, con dos programas de carga para coche y moto, con pantalla LCD, voltímetro digital y doble función de cargador y tester de la batería y del sistema de carga del vehículo. BC 3500 EVO es ideal para la recuperación, la carga, la desulfatación, el mantenimiento y el análisis de baterías de 12V, y puede permanecer siempre conectado a la batería sin riesgo y sin necesidad de desconectarla del vehículo. El cargador dispone de dos programas de cargas específicos: CAR MODE con una corriente máxima de 3,5 Amperios, y BIKE MODE con una corriente máxima de 0,9 Amperios. Recupera baterías profundamente descargadas (a partir de una tensión de 1,5 Voltios) El procedimiento automático de test, guiado por las instrucciones en la pantalla LCD, incluye un análisis del estado de la batería en reposo, una prueba en esfuerzo al arranque del motor y una prueba del sistema de carga del vehículo (alternador y regulador).

FICHA TÉCNICA	BC 3500 EVO
Tensión de carga	13,8 V / 14,4 V - nominal 12 V
Corriente de carga	3,5 A máx. (CAR MODE), 0,9 A máx. (BIKE MODE)
Tipos de baterías	12 V de plomo-ácido (de gel, abiertas, MF, AGM, VRLA, Ca/Ca...)
Capacidad de batería -CAR MODE	15 Ah a 80 Ah (Carga), hasta 150 Ah (Mantenimiento)
Capacidad de la batería -BIKE MODE	3 Ah a 60 Ah (Carga), hasta 100 Ah (Mantenimiento)
Temperatura de funcionamiento	-20º a +50º C



Bobina encendido

Las dos bobinas sirven para la mayoría de motos, compare las medidas del cuadro inferior con las medidas de la bobina original y rápidamente obtendrá la referencia requerida. Si prefiere concretar el modelo llámenos.

€
23,89



DMX01002



DMX01003

Referencia	Largo	Distancia entre agujeros	Ø Agujero	Grosor	Distancia cable	Primario Ohmios	Secundario Ohmios
DMX01002	66mm	55mm	7mm	8.2mm	330mm	0.6	5430
DMX01003	90mm	80mm	6mm	7mm	280mm	0.5	5410
DAT01344					410mm		



Estátor

HONDA

Año	Referencia	€
CRF 450 X	DMX01350	114,54

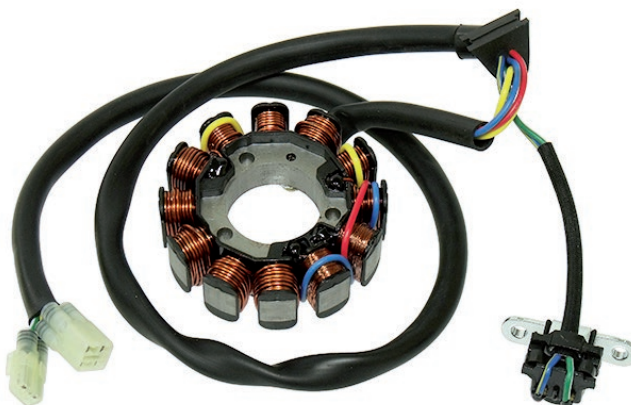

Juntas de estátor

HONDA

Año	Referencia	Referencia Original	€
XR 400 R	NA10003CG2	11395-KCY-671 11395-KCY-672	8,54

KAWASAKI

Año	Referencia	Referencia Original	€
KLR650	NX20019CG2	11060-1113 11060-1693	10,11

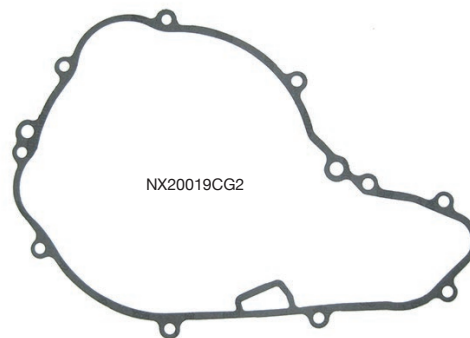



Motor arranque y kit de reparación escobillas



DMX01304



DMX01300



DMX01301



DMX01252

			MOTOR COMPLETO		KIT REPARACIÓN	
HUSABERG						
Año	Ref. Original	Referencia	€	Referencia	€	
TE 250	11-12	55140002044		DMX01252	13,23	
TE 300	2012	55140002044		DMX01252	13,23	
			MOTOR COMPLETO		KIT REPARACIÓN	
KTM						
Año	Ref. Original	Referencia	€	Referencia	€	
250 EXC-F	2007	77040001000	DMX01300	168,00		
250 EXC-F	2013	77040001000	DMX01300	168,00		
250 SX	2012	77040001000	DMX01300	168,00		
250 SX-F	07-12	77040001000	DMX01300	168,00		
250 XC	09-12	55140002044		DMX01252	13,23	
200 XC-W	08-13	55140002044		DMX01252	13,23	
250 XCF-W	07-13	77040001000	DMX01300	168,00		
300 EXC-E	2007	55140002044		DMX01252	13,23	
300 XC	09-12	55140002044		DMX01252	13,23	
300 XC-W	08-12	55140002044		DMX01252	13,23	
450 SMR	08-12	77340001000	DMX01304	168,00		
450 SX-E	07-09	77340001000	DMX01304	168,00		
450 XC-F	08-12	77340001000	DMX01304	168,00		
505 SX-F	07-09	77340001000	DMX01304	168,00		
505 XC-F	08-09	77340001000	DMX01304	168,00		
			MOTOR COMPLETO		KIT REPARACIÓN	
YAMAHA						
Año	Ref. Original	Referencia	€	Referencia	€	
WR 250 F	06-16	5UM-81801-10		DMX01251		
YZ 250 FX	15-16	5UM-81801-10		DMX01251		
WR 450 F	03-06	5TJ-81890-00-00 5TJ-81890-10-00 5TJ-81890-20-00	DMX01302	168,00		
WR 450 F	07-14	5TJ-81890-30-00	DMX01301	168,00		

Regulador corriente

Yamaha WR 250 F 03-05
Yamaha WR 450 F 03-04

Referencia	Descripción	€
DMX01150	12V - 25A	59,40



Pipa de bujía con resistencia

Yamaha WR 250 R 08-15

Referencia	Descripción	€
DSM01123	1,3Ω / 9,6Ω	



XPEED Pipas de bujía



Referencia	Descripción	€
E28-47800	Silicona	1,25



Referencia	Descripción	€
D0110904	Tipo NGK	2,22



Referencia	Descripción	€
D01110B	Con cable 50cm	3,90



Referencia	Descripción	€
D0110924	Silicona con resistencia	5,99



Referencia	Descripción	€
D0110923	Silicona con resistencia	5,99



Bujías NGK



Referencia	€	Referencia	€	Referencia	€	Referencia	€		
B10EG	8,26	BP6HS	3,22	BR8EIX	18,89	CR8E	10,14	DPR8EA9	4,84
B10EGV	18,28	BP7ES	3,22	BR8ES	4,84	CR8EB	10,14	DPR8EIX-9	18,89
B10ES	3,74	BP7HS	3,22	BR8EVX	17,89	CR8EH9	12,17	DPR8EVX9	17,89
B10EVX	12,94	BP8ES	3,72	BR8HIX	18,89	CR8EHIX9	18,89	DPR8Z	10,14
B10HS	3,86	BP8HS	3,74	BR8HS	4,84	CR8EHVX9	17,89	DPR9EA9	4,84
B10HVX	12,94	BP9ES	4,63	BR8HS10	4,54	CR8EIB10	13,71	DPR9EIX9	18,89
B5ES	3,74	BPM6A	3,06	BR8HSA	4,71	CR8EIX	18,89	DPR9EVX9	17,89
B5HS	3,22	BPM7A	3,06	BR9ECM	10,14	CR8EK	11,54	DPR9Z	10,14
B6ES	3,67	BPMR6F	4,66	BR9ECS	10,14	CR8EKB	11,54	DR7EA	4,71
B6HS	3,67	BPMR7A	4,23	BR9EG	10,14	CR8EVX	17,89	DR7ES	4,71
B7ES	3,67	BPR5ES	3,84	BR9EIX	18,89	CR8HIX	18,89	DR8EA	4,84
B7HS	3,67	BPR5ES11	3,84	BR9ES	4,84	CR8HSA	4,71	DR8EB	10,43
B8EG	8,26	BPR6ES	3,84	BR9EVX	17,89	CR9E	10,14	DR8EIX	18,89
B8EGV	18,28	BPR6HS	3,84	BR9HIX	18,89	CR9EB	10,14	DR8ES	4,84
B8ES	3,67	BPR6HSA	4,71	BR9HS	4,71	CR9EH9	12,17	DR8ESL	4,84
B8HS	3,67	BPR7EIX	19,06	C6HSA	3,74	CR9EH19	21,94	DR9EA	4,84
B8HVX	12,94	BPR7ES	3,84	C7HSA	3,74	CR9EHIX9	18,89	IFR8H11	34,54
B9EG	8,26	BPR7HS	4,84	CMR6H	5,14	CR9EHVX9	17,89	IFR9H11	34,54
B9EGV	18,28	BPR8ES	4,84	CPR6EA9	10,14	CR9EIA9	14,43	IJR8B9	37,31
B9ES	3,67	BPR8HS	4,71	CPR7EA9	10,14	CR9EIX	18,89	IMR8C9H	34,54
B9EVX	12,94	BPR8HSA	4,71	CPR8E	10,14	CR9EK	11,71	IMR9A9H	30,60
B9HS	3,67	BPR9ES	4,84	CPR8EA9	10,14	CR9EKB	14,83	IMR9B9H	34,54
B9HVX	12,94	BR10ECM	10,14	CPR9EA9	10,14	CR9EKPA	14,06	IMR9C9H	33,26
BCP7ES	3,22	BR10ECMVX	17,89	CR10E	10,14	CR9EVX	17,89	IMR9C9HES	30,03
BKR5ES	4,63	BR10ECS	10,14	CR10EIX	18,89	D7EA	3,74	IMR9E9HES	30,03
BKR6E	4,34	BR10EG	10,14	CR10EK	11,54	D8EA	3,74	J9A	8,26
BKR7E	5,31	BR10EIX	18,89	CR6HS	4,71	D9EA	3,74	JR10B	7,49
BKR7EIX	19,06	BR10ES	4,71	CR6HSA	4,71	DCPR7E	7,31	JR9B	7,49
BKR7EKC	9,26	BR2LM	4,23	CR7E	10,14	DCPR8E	8,38	JR9C	9,94
BM6A	3,06	BR4HS	4,66	CR7EB	10,14	DCPR8EIX	19,06	LMAR8A9	20,60
BM6F	3,06	BR6ES	4,63	CR7EH9	12,17	DCPR8EKC	11,13	MAR10AJ	21,49
BM7A	3,06	BR6HS	4,71	CR7EIX	18,89	DCPR8EKP	19,63	PMR8B	32,50
BMR7A	4,66	BR6HSA	4,71	CR7EK	11,54	DCPR9E	8,47		
BP5ES	3,16	BR7ES	4,71	CR7EKB	11,54	DCPR9EIX	19,06		
BP5HS	3,56	BR7HS	4,84	CR7HIX	18,89	DCPR9EVX	18,31		
BP6ES	3,16	BR8ECM	10,14	CR7HS	4,84	DPR6EA9	4,71		
		BR8EG	10,14	CR7HSA	4,71	DPR7EA9	4,84		

XPEED Interruptor



Referencia	Descripción	€
DUP01107	Ø 8 mm	5,35



Referencia	Descripción	€
DUP011071	Ø 8 mm	5,35



Referencia	Descripción	€
DUP01360	Ø 8 mm	5,16



Referencia	Descripción	€
D1216604	Ø 8 mm	6,90

XPEED Interruptor de freno mecánico



Referencia	Descripción	€
E46-50700	YAMAHA	5,84



Referencia	Descripción	€
DMX01006	YAMAHA	6,84



Referencia	Descripción	€
DMC01698	YAMAHA	13,23



Referencia	Descripción	€
DAT01524	HONDA	15,66

XPEED Interruptor de embrague



Referencia	Descripción	€
DMX01050	HONDA	7,35

XPEED Interruptor de freno hidráulico



Referencia	Descripción	€
DMC01323	Japonesas M10 x 1,25	13,83
DMC013231	Europeas M10 x 1,00	13,83



Referencia	Descripción	€
DMC013282	Japonesas M10 x 1,25	13,83
DMC013283	Europeas M10 x 1,00	13,83

RUEDAS Y NEUMÁTICOS

MOTOR

ADMISIÓN / ESCAPE
REFRIGERACIÓN

ELÉCTRICO

SUSPENSIÓN / DIRECCIÓN

FRENOS

TRANSMISIÓN

CONTROLES Y MANDOS

CHASIS

ACCESORIOS



Conmutador luces



Referencia	Descripción	€
DMX01024	KTM, HUSABERG, HUSQVARNA	22,35

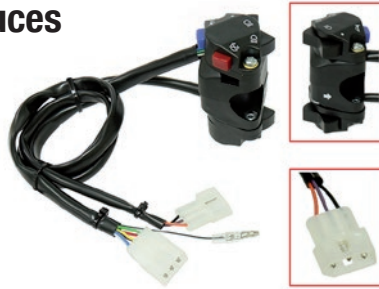

Referencia	Descripción	€
DMX010241	KTM, HUSABERG, HUSQVARNA	32,24



Referencia	Descripción	€
DMX01027	KTM	



Interruptores de arranque



Referencia	Descripción	€
DMX01023	CRF 250 X 04-16 CRF 450 X 05-07	22,20



Referencia	Descripción	€
DMX010231	CRF 250 X 04-13 CRF 450 X 05-07	16,92



Referencia	Descripción	€
DMX01011	KLX 140 08-10 KLX 450 R 08-12	13,88



Referencia	Descripción	€
DMX01013	KTM	12,88



Referencia	Descripción	€
DMX01014	DR-Z 250 01-07 DR-Z 400 00-07	13,32



Referencia	Descripción	€
DMX01012	TT-R 230 05-14 WR 250 F 03-06 WR 450 F 03-06	13,88



Interruptores bomba gasolina



Referencia	Descripción	€
DMX01025	CRF 250 R 15-16 CRF 450 R 15-16	32,72



Referencia	Descripción	€
DMX01028	KX 250 F 13-16 KX 450 F 12-16	26,67

XPEED Interruptores de paro



Referencia	Descripción	€
DMC010221	KTM	15,60



Referencia	Descripción	€
DMC01116	YAMAHA	11,48



Referencia	Descripción	€
DMC011181	KTM	11,90



Referencia	Descripción	€
DMX01009	YZ 250 F 10-11	16,93



Referencia	Descripción	€
DMX01010	YZ 450 F 10-13	14,90



Referencia	Descripción	€
DMX01007BK	HONDA / KTM / KAWASAKI / SUZUKI / YAMAHA	20,88



Referencia	Descripción	€
DMX01008	CRF 250 R 10-13 CRF 450 R 09-12	25,20



Referencia	Descripción	€
DMC01117	SUZUKI	10,64



Referencia	Descripción	€
DMC01118	KAWASAKI	10,88



Referencia	Descripción	€
DMX01026	KX 250 F 06-16 KX 450 F 06-15	12,74



Referencia	Descripción	€
DMX01029	CRF 450 R 13-14	28,77



Referencia	Descripción	€
DMX01030	WR 250 F 15-16 YZ 250 F 14-16 WR 450 F 2016 YZ 450 F 15-16	14,97

Juego conectores macho y hembra



Referencia	Descripción	€
DUP01060	2 terminales	2,90



Referencia	Descripción	€
DUP01061	3 terminales	3,59



Referencia	Descripción	€
DUP01062	4 terminales	4,27

XSM01085A



Toma corriente

Referencia	Descripción	€
XSM01085A	Toma Mechero	8,58
DUP01251	Toma USB	22,50



Faros halógenos

Precio faro por 1 unidad.
*Instalación eléctrica con todo el material necesario.

Referencia	Descripción	Diámetro	Largo	€
DMP01102	A 35W Negro	45	60	12,10
DMP01102P	A 35W Cromado	45	60	9,30
DMP01103	B 50W Negro	60	65	15,80
DMP01666	C 20W Negro	35	50	7,90
DMP01666P	C 20W Cromado	35	50	7,90
DMC01633	Instalación eléctrica, relé, interruptor			13,28



Relés de arranque



Referencia	Descripción	€
DAT01097	12V 80A	20,93



Referencia	Descripción	€
DAT01098		20,00



Referencia	Descripción	€
DAT01100	YAMAHA	39,84



Referencia	Descripción	€
DAT01105	YAMAHA	21,55



Referencia	Descripción	€
DAT01751	HONDA	14,73



Referencia	Descripción	€
DMC01696	12V 30A	24,03

Limitador velocidad y RPM

Especialmente concebido para alquileres o niños, donde lo que se pretende es limitar la velocidad y revoluciones del vehículo.

Para ofrecer la máxima seguridad al conductor sin perjudicar el funcionamiento del motor, con un mínimo coste y rapidez.



Referencia	€
D12474	25,50



Alargo guardabarros led

Guardabarros con luz led, de posición y freno, homologada.

Referencia	€
DMX042241	22,84

SUSPENSIÓN DIRECCIÓN



SUSPENSIÓN / DIRECCIÓN



Kit de reparación dirección



€
40

APRILIA

Año	Referencia
RXV 550	06-08 DMX08281
SXV 550	06-08 DMX08281

BMW

Año	Referencia
F 650 GS	99-02 DMX08281
F 650 GS Dakar	00-05 DMX08281
F 650 GGS	00-05 DMX08281
F 650 GS M	03-07 DMX08281
F 650 GS K 72	06-10 DMX08281
G 650 GS	08-09 DMX08281

BETA

Año	Referencia
REV 50	06-08 DMX08198
EVO 80	09-11 DMX08198
EVO JR 80	09-11 DMX08198
REV 80	06-08 DMX08198
EVO 2T 125	09-14 DMX08198
REV 2T 125	04-08 DMX08198
EVO 2T 200	09-13 DMX08198
REV 2T 200	04-08 DMX08198
EVO 2T 250	09-13 DMX08198
EVO 4T 250	09-12 DMX08198
REV 2T 250	04-08 DMX08198
REV 4T 250	2008 DMX08198
REV 2T 270	04-08 DMX08198
EVO 2T 290	09-11 DMX08198
EVO 2T 300	12-13 DMX08198
EVO 4T 300	09-12 DMX08198

GAS GAS

Año	Referencia
MC 65	2006 DMX08198
PAMPERA 125	02-05 DMX08198
TXT 125	02-12 DMX08198
TXT 200	02-09 DMX08198
PAMPERA 250	02-05 DMX08198
TXT 250	02-12 DMX08198
PAMPERA 280	02-05 DMX08198
TXT 280	02-12 DMX08198
TXT 300	02-13 DMX08198

HONDA

Año	Referencia
CR 80 R	87-02 DMX08180
CR 80 RB	96-02 DMX08180
CR 85 R	03-07 DMX08180
CR 125 R	85-89 DMX08180
CR 125 R	90-92 DMX08181
CR 125 R	93-07 DMX08182
CR 150 F	03-16 DMX08180
CR 150 R	07-16 DMX08180
CR 150 RB	07-16 DMX08180
XR 200 R	85-02 DMX08180
CRF 230 F	03-16 DMX08180
CR 250 R	85-87 DMX08180
CR 250 R	90-94 DMX08181
CRF 250 R	04-09 DMX08182
CRF 250 R	10-12 DMX08280
CRF 250 X	04-16 DMX08182
XL 250 R	85-87 DMX08180

XR 250 R	85-04	DMX08180
XL 350 R	1985	DMX08180
CB 400 F	89-90	DMX08181
XR 400 R	96-04	DMX08180
CRF 450 R	02-08	DMX08182
CRF 450 R	09-12	DMX08280
CRF 450 X	05-16	DMX08182
CR 500 R	90-01	DMX08181
CB 600 F	04-06	DMX08181
XL 600 R	86-87	DMX08180
XL 600 V Transalp	89-90	DMX08180
XR 600 R	85-00	DMX08180
XR 650 L	93-16	DMX08180
XR 650 R	00-07	DMX08181

HUSABERG

Año	Referencia
250 FE	13-14 DMX08190
250 TE	11-14 DMX08190
300 TE	11-14 DMX08190
350 FE	2013 DMX08190
390 FE	10-11 DMX08190
450 FE	09-14 DMX08190
450 FX	10-11 DMX08190
501 FE	13-14 DMX08190
570 FE	09-11 DMX08190
570 FS	10-11 DMX08190

HUSQVARNA

Año	Referencia
TXC 10	2008 DMX08190
CR 125	99-08 DMX08190
WR 125	2008 DMX08190
CR 250	99-04 DMX08190
TC 250	03-08 DMX08190
TE 250	2008 DMX08190
TE 250	2011 DMX08190
TXC 250	2008 DMX08190
WR 250	2008 DMX08190
TE 300	2011 DMX08190
390 FE	10-11 DMX08190
450FE	09-11 DMX08190
450FX	10-11 DMX08190
SM450R	2008 DMX08190
TC450	03-08 DMX08190
TE450	2008 DMX08190
TXC450	2008 DMX08190
TC510	2008 DMX08190
SM510R	2008 DMX08190
570FE	09-11 DMX08190
570FS	10-11 DMX08190
TC570	01-02 DMX08190
SM610	2008 DMX08190
TC610	99-00 DMX08190
TE610	2008 DMX08190

KAWASAKI

Año	Referencia
KX 65	00-15 DMX08184
KX 80	86-00 DMX08184
KX 85	01-15 DMX08184
KX 100	95-15 DMX08184

KX 125	92-05	DMX08187
KLX 125	03-06	DMX08185
KLX 140	08-15	DMX08184
KDX 200	83-06	DMX08295
KDX 220	97-05	DMX08295
KX 250	92-07	DMX08187
KX 250 F	04-16	DMX08187
KLX 400	2003	DMX08189
KLX 450 R	08-09	DMX08187
KX 450 F	06-16	DMX08187

KTM

Año	Referencia
50 SX	06-14 DMX08198
50 SXS	11-13 DMX08198
50 SM	2006 DMX08198
50 SX Mini	09-14 DMX08198
60 SX	98-00 DMX08198
65 SX	98-14 DMX08198
65 XC	08-09 DMX08198
85 SX	03-14 DMX08198
85 XC	08-09 DMX08198
105 XC	08-09 DMX08198
105 SX	06-11 DMX08198
125 EGS	93-99 DMX08190
125 EXC	93-09 DMX08190
125 EXE	00-01 DMX08190
125 SX	93-14 DMX08190
125 SXS	2004 DMX08190
144 SX	07-08 DMX08190
150 SX	09-14 DMX08190
150 XC	10-14 DMX08190
200 EGS	98-99 DMX08190
200 EXC	98-05 DMX08190
200 MXC	98-03 DMX08190
200 SX	00-04 DMX08190
200 XC	06-09 DMX08190
200 XC-W	06-13 DMX08190
250 EGS	94-99 DMX08190
250 EXC	94-05 DMX08190
250 EXC-G Racing	02-05 DMX08190
250 MXC	98-01 DMX08190
250 SX	94-14 DMX08190
250 SX-F	05-14 DMX08190
250 SXS	01-04 DMX08190
250 XC	06-14 DMX08190
250 XC-F	07-14 DMX08190
250 XC-FW	07-14 DMX08190
300 EGS	94-99 DMX08190
300 EXC	94-05 DMX08190
300 MXC	94-05 DMX08190
300 SX	1994 DMX08190
300 XC	06-14 DMX08190
300 XC-W	06-14 DMX08190
350 LC4	94-95 DMX08190
350 SX-F	11-14 DMX08190
350 XC-F	12-14 DMX08190
360 EGS	96-97 DMX08190
360 EXC	96-97 DMX08190
360 MXC	96-97 DMX08190



Kit de reparación dirección



360 SX	96-97	DMX08190
380 EGS	98-99	DMX08190
380 EXC	98-02	DMX08190
380 MXC	98-01	DMX08190
380 SX	98-02	DMX08190
400 Duke	94-95	DMX08190
400 EGS	94-97	DMX08190
400 EGS-E	1997	DMX08190
400 EXC	94-02	DMX08190
400 EXC-G	04-06	DMX08190
400 LC	98-99	DMX08190
400 LC4-E	00-01	DMX08190
400 LSE	1997	DMX08190
400 MXC	01-02	DMX08190
400 RXC	95-98	DMX08190
400 SC	2000	DMX08190
400 SX	98-02	DMX08190
400 SXC	97-00	DMX08190
400 TXC	1998	DMX08190
400 XC-W	07-10	DMX08190
440 EXC	94-95	DMX08190
440 MXC	1994	DMX08190
440 SX	1994	DMX08190
450 EXC	03-11	DMX08190
450 EXC-G	04-07	DMX08190
450 EXC-R	2008	DMX08190
450 MXC-G	03-05	DMX08190
450 SMR	05-07	DMX08190
450 SMS	03-04	DMX08190
450 SX	03-06	DMX08190
450 SX-F	07-13	DMX08190
450 SXS	03-04	DMX08190
450 XC	04-07	DMX08190
450 XC-F	08-14	DMX08190
450 XC-W	07-14	DMX08190
450 XCR-W	2008	DMX08190
500 LC4	91-92	DMX08190
500 XC-W	12-14	DMX08190
505 SX-F	2008	DMX08190
505 XC-F	08-09	DMX08190
520 EXC	00-02	DMX08190
520 MXC	01-02	DMX08190
520 SX	00-02	DMX08190
525 EXC	03-07	DMX08190
525 SX	03-06	DMX08190
525 MXC-G	03-05	DMX08190
525 SMR	2005	DMX08190
525 XC	06-07	DMX08190
525 XC-W	2007	DMX08190
530 EXC	09-11	DMX08190
530 EXC-R	08-09	DMX08190
530 XCR-W	2008	DMX08190
530 XC-W	09-11	DMX08190
550 MXC	94-96	DMX08190
560 SMR	06-07	DMX08190
600 LC4	91-92	DMX08190
620 Duke	94-97	DMX08190
620 EGS	94-97	DMX08190
620 EGS-E	1997	DMX08190
620 EXC	94-95	DMX08190

620 LC4	97-98	DMX08190
620 LC4 Comp	1999	DMX08190
620 LC4 SuperMoto	1999	DMX08190
620 RXC	95-97	DMX08190
620 SuperMoto	1998	DMX08190
620 SX	97-99	DMX08190
620 SXC	1997	DMX08190
620 TXC	1998	DMX08190
625 SXC	03-05	DMX08190
625 SMC	04-06	DMX08190
640 Adventure	98-07	DMX08190
640 LC4	2005	DMX08190
640 LC4 Adventure	06-07	DMX08190
640 SuperMoto	99-01	DMX08190
690 Duke	2008	DMX08190
690 Rally	2008	DMX08190
690 Enduro	09-12	DMX08190
950 Adventure	03-06	DMX08190
950 Superenduro	2007	DMX08190
950 SM	05-06	DMX08190
990 Adventure	07-12	DMX08190
990 Supermoto	10-11	DMX08190
990 Super Duke	06-08	DMX08190

TM	Año	Referencia
MX 85	06-09	DMX08184
EN 125	96-97	DMX08184
EN 125	02-11	DMX08182
MX 125	96-97	DMX08184
MX 125	02-11	DMX08182
SMX 125	05-08	DMX08182
SMR 125	2009	DMX08182
EN 144	08-11	DMX08182
MX 144	08-11	DMX08182
EN 250	96-97	DMX08184
EN 250	02-11	DMX08182
EN 250 F	02-11	DMX08182
MX 250	96-97	DMX08184
MX 250	02-11	DMX08182
MX 250 F	02-11	DMX08182
EN 300	1997	DMX08184
EN 300	02-11	DMX08182
MX 300	1997	DMX08184
MX 300	02-11	DMX08182
EN 400 F	02-03	DMX08182
MX 400 F	02-03	DMX08182
EN 450 F	04-11	DMX08182
MX 450 F	04-11	DMX08182
SMR 450 F	2009	DMX08182
SMX 450 F	05-07	DMX08182
SM 450 F	2008	DMX08182
EN 530 F	02-11	DMX08182
MX 530 F	02-11	DMX08182
SMR 530 F	08-09	DMX08182
SMX 660	06-07	DMX08182
SMX 660 F	08-09	DMX08182
SMX 660 S	2005	DMX08182

SHERCO	Año	Referencia
TRIALS 0.80		DMX08198
TRIALS 1.25		DMX08198
TRIALS 2.0		DMX08198
TRIALS 2.5		DMX08198
TRIALS 2.9		DMX08198
TRIALS 3.0		DMX08198
TRIALS 3.2 4T		DMX08198

SUZUKI	Año	Referencia
RM 65	03-05	DMX08184
RM 100	2003	DMX08184
DR 125 S	94-96	DMX08197
DRZ 125 L	03-08	DMX08189
RM 125	1988	DMX08197
RM 125	89-90	DMX08197
RM 125	93-04	DMX08189
RM 125	05-08	DMX08284
DRZ 125	03-08	DMX08185
DRZ 125 L	03-08	DMX08185
DR 200	86-88	DMX08197
DR 250	90-93	DMX08197
RM 250	93-04	DMX08189
RM 250	05-08	DMX08284
RMX 250	93-98	DMX08189
RMZ 250	04-06	DMX08187
RMZ 250	07-08	DMX08284
RMZ 250	09-12	DMX08197
DR-Z 400 E	00-07	DMX08189
DR-Z 400 K	00-04	DMX08189
DR-Z 400 S	00-12	DMX08189
DR-Z 400 SM	05-09	DMX08189
RMX 450	2010	DMX08197
RMZ 450	05-07	DMX08284
RMZ 450	08-12	DMX08197
DR 650 SE	96-11	DMX08189

YAMAHA	Año	Referencia
YZ 80	93-01	DMX08184
YZ 85	02-14	DMX08184
YZ 125	96-12	DMX08193
TT 230 R	05-12	DMX08295
XT 250	08-12	DMX08184
YZ 250	96-12	DMX08193
YZ 250 F	01-12	DMX08193
WR 250 F	01-12	DMX08193
WR 250 R	08-12	DMX08193
WR 250 X	08-12	DMX08193
YZ 400 F	98-99	DMX08193
WR 400 F	98-00	DMX08193
YZ 426 F	00-02	DMX08193
WR 426 F	00-02	DMX08193
YZ 450 F	03-12	DMX08193
WR 450 F	03-11	DMX08193

RUEDAS Y NEUMÁTICOS

MOTOR

ADMISIÓN / ESCAPE
REFRIGERACIÓN

ELÉCTRICO

SUSPENSIÓN / DIRECCIÓN

FRENS

TRANSMISIÓN

CONTROLES Y MANDOS

CHASIS

ACCESORIOS

YAMAHA	Año	Referencia	€
YZ 80	93-01	DMX04169	29,68
YZ 85	2002	DMX04169	29,68
YZ 85	03-16	DMX04170	28,07
YZ 125	98-00	DMX04171	45,29
YZ 125	01-16	DMX04172	44,17
WR 250 F	01-13	DMX04172	44,17
YZ 250	98-00	DMX04171	45,29
YZ 250	01-15	DMX04172	44,17

YZ 250 F	01-06	DMX04172	44,17
YZ 250 F	07-16	DMX04139	43,26
YZ 400 F	98-99	DMX04171	45,29
WR 426 F	01-02	DMX04172	44,17
YZ 426 F	2000	DMX04171	45,29
YZ 426 F	01-02	DMX04172	44,17
WR 450 F	98-00	DMX04171	45,29
WR 450 F	03-15	DMX04172	44,17
YZ 450 F	03-16	DMX04172	44,17



Kit reparación bieleta completo

Incluye todo el material para reparar la bieleta, incluso la sujeción del amortiguador.
* Las referencias marcadas con Asterisco (*) no incluyen reparación de amortiguador.

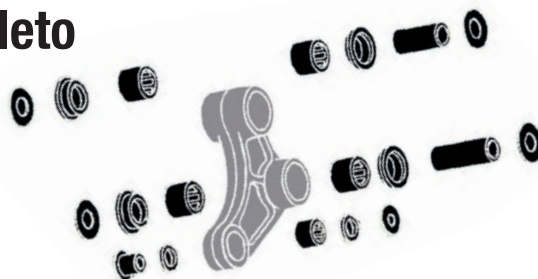

HONDA	Año	Referencia	€
XR 80 R	01-03	DMX04108*	40,98
CR 80	96-02	DMX041061	44,35
CR 85	03-07	DMX041061	44,35
CRF 80 F	04-13	DMX04108*	40,98
CRF 100 F	04-13	DMX04108*	40,98
CR 125 R	1996	DMX041013	66,71
CR 125 R	1997	DMX041011	53,01
CR 125 R	98-99	DMX041021	51,10
CR 125 R	00-01	DMX041031	59,80
CR 125 R	02-04	DMX042481	69,70
CR 125 R	05-07	DMX042482	79,00
CRF 150 F	03-17	DMX041091	64,17
CRF 150 R	07-17	DMX041471	56,80
CRF 150 RB	07-17	DMX041471	56,80
CRF 230 F	03-17	DMX041091	64,17
CR 250 R	1996	DMX041013	66,71
CR 250 R	1997	DMX041012	53,70
CR 250 R	98-99	DMX041021	51,10
CR 250 R	00-01	DMX041031	59,80
CR 250 R	02-04	DMX042481	69,70
CR 250 R	05-07	DMX041251	75,62
CRF 250 R	2004	DMX042481	69,70
CRF 250 R	05-09	DMX042482	79,00
CRF 250 R	10-17	DMX04167	70,31
CRF 250 X	2006	DMX041251	75,62
CRF 250 X	07-15	DMX041291	75,62
CRF 450 R	02-04	DMX042481	69,70
CRF 450 R	05-08	DMX041251	75,62
CRF 450 R	09-17	DMX04167	70,31
CRF 450 X	05-15	DMX041251	75,62
CR 500 R	96-01	DMX041051	78,35

KAWASAKI	Año	Referencia	€
KX 60	85-03	DMX04113*	44,53
KX 65	00-01	DMX04114	47,80
KX 65	02-15	DMX041151	63,69
KX 80	90-00	DMX041241	54,75
KX 85	01-17	DMX041241	54,75
KX 100	98-17	DMX041241	54,75
KX 125	94-98	DMX041211	50,82
KX 125	99-03	DMX04123	45,73
KX 125	04-05	DMX042501	63,36
KDX 200	95-06	DMX041211	50,82
KDX 220	95-06	DMX041211	50,82
KX 250	1998	DMX041212	53,60
KX 250	99-03	DMX04123	45,73
KX 250	04-07	DMX042501	63,36
KX 250 F	04-05	DMX042501	63,36
KX 250 F	06-16	DMX04281	60,11
KLX 300 R	93-07	DMX04283	57,00
KLX 400	2003	DMX041491	56,30
KLX 450 R	08-09	DMX04281	60,11
KX 450 F	06-16	DMX04281	60,11

KTM	Año	Referencia	€
125 SX	12-15	DMX04168	82,57
150 SX	12-15	DMX04168	82,57
150 XC	12-14	DMX04168	82,57
250 SX	12-15	DMX04168	82,57
250 SX-F	11-15	DMX04168	82,57
250 XC	12-15	DMX04168	82,57
250 XC-F	11-15	DMX04168	82,57
300 XC	12-15	DMX04168	82,57
350 SX-F	11-15	DMX04168	82,57
350 XC-F	12-15	DMX04168	82,57
450 SX-F	11-15	DMX04168	82,57
450 XC-F	13-15	DMX04168	82,57

SUZUKI	Año	Referencia	€
RM 65	03-05	DMX041151	58,59
RM 80	90-01	DMX041451	69,86
RM 85	02-04	DMX041451	69,86
RM 85	05-17	DMX041452	64,68
RM 85 L	05-12	DMX041452	64,68
RM 100	2003	DMX042521	75,08
RM 125	93-95	DMX04143	46,50
RM 125	96-97	DMX041411	65,30
RM 125	98-99	DMX041421	49,03
RM 125	2000	DMX04144	44,02
RM 125	2001	DMX041461	53,13
RM 125	02-03	DMX041462	58,25
RM 125	2004	DMX042521	75,08
RM 125	05-07	DMX041171	78,80
RM 250	93-95	DMX04143	46,50
RM 250	96-97	DMX041411	65,30
RM 250	98-99	DMX041421	49,03
RM 250	2000	DMX04144	44,02
RM 250	2001	DMX041461	53,13
RM 250	02-03	DMX041462	58,25
RM 250	2004	DMX042521	75,08
RM 250	05-09	DMX041171	78,80
RM-Z 250	04-06	DMX042501	63,36
RM-Z 250	07-09	DMX041171	78,80
RM-Z 250	10-12	DMX041501	75,46
RM-Z 250	13-14	DMX04524	87,71
DR-Z 400 E	00-07	DMX041491	52,67
DR-Z 400 SL	00-14	DMX041491	52,67
DR-Z 400 SM	05-16	DMX041491	52,67
RM-Z 450	05-09	DMX041171	78,80
RM-Z 450	10-12	DMX041501	75,46
RM-Z 450	13-14	DMX04524	87,71
RMX 450	2010	DMX04150	57,00

YAMAHA	Año	Referencia	€
YZ 80	93-01	DMX041621	69,35
YZ 85	03-17	DMX041622	67,82
YZ 125	94-00	DMX041611	75,30
YZ 125	2001	DMX041612	73,88
YZ 125	02-04	DMX041631	67,80
YZ 125	2005	DMX042531	80,62
YZ 125	06-17	DMX04522	87,45
WR 250	94-97	DMX041611	75,30
WR 250 F	2001	DMX041612	73,88
WR 250 F	02-04	DMX041631	67,88
WR 250 F	2005	DMX042531	80,62
WR 250 F	07-13	DMX041641	87,70
YZ 250	94-00	DMX041611	75,30
YZ 250	2001	DMX041612	73,88
YZ 250	02-04	DMX041631	67,88
YZ 250	2005	DMX042531	80,62
YZ 250	06-17	DMX04522	87,45
YZ 250 F	2001	DMX041612	73,88
YZ 250 F	02-04	DMX041631	67,88
YZ 250 F	2005	DMX042531	80,62
YZ 250 F	2006	DMX04164	71,28
YZ 250 F	2007	DMX042821	86,10
YZ 250 F	2008	DMX042822	78,45
YZ 250 F	09-17	DMX041661	85,22
WR 400 F	98-00	DMX041611	75,30
YZ 400 F	98-99	DMX041611	75,30
WR 426 F	01-02	DMX041612	73,88
YZ 426 F	2000	DMX041611	75,30
YZ 426 F	2001	DMX041612	73,88
WR 450 F	03-04	DMX041631	67,88
WR 450 F	2005	DMX042531	80,62
WR 450 F	07-15	DMX041641	87,70
YZ 450 F	03-04	DMX041631	67,88
YZ 450 F	2005	DMX042531	80,62
YZ 450 F	06-08	DMX041641	87,70
YZ 450 F	09-17	DMX041661	85,22





Kit reparación basculante

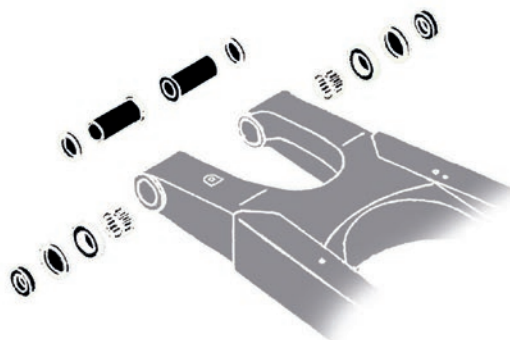

GAS GAS	Año	Referencia	€
EC 125	02-11	DMX04293	63,63
MC 125	02-09	DMX04293	63,63
MX 125	02-07	DMX04293	63,63
SM 125	02-08	DMX04293	63,63
EC 200	02-11	DMX04293	63,63
MC 200	02-07	DMX04293	63,63
MX 200	02-07	DMX04293	63,63
SM 200	02-07	DMX04293	63,63
EC 250	02-11	DMX04293	63,63
MC 250	02-09	DMX04293	63,63
MX 250	02-07	DMX04293	63,63
SM 250	02-07	DMX04293	63,63
EC 300	02-11	DMX04293	63,63
MC 300	02-07	DMX04293	63,63
MX 300	02-07	DMX04293	63,63
SM 300	02-07	DMX04293	63,63

HONDA	Año	Referencia	€
CRF 50 F	04-16	DMX04256	47,67
XR 50 R	00-03	DMX04256	47,67
XR 70 R	00-03	DMX04256	47,67
CRF 70 F	04-11	DMX04256	47,67
CR 80 R	96-97	DMX04175	32,27
CR 80 R	98-99	DMX04177	33,46
CR 80 R	00-02	DMX04178	34,23
CR 85 R	03-07	DMX04178	34,23
CR 125 R	89-92	DMX04173	53,69
CR 125 R	93-01	DMX04174	49,63
CR 125 R	02-07	DMX04179	50,61
CRF 150 R	07-17	DMX04298	34,23
CRF 150 RB	07-17	DMX04298	34,23
CRF 230 F	03-17	DMX04295	49,00
CR 250 R	88-91	DMX04173	53,69
CR 250 R	92-01	DMX04176	54,89
CR 250 R	02-07	DMX04180	51,17
CRF 250 R	04-09	DMX04257	54,95
CRF 250 R	10-13	DMX04383	54,39
CRF 250 R	2014	DMX04385	51,17
CRF 250 X	04-16	DMX04257	54,95
CRF 450 R	02-04	DMX04180	51,17
CRF 450 R	05-08	DMX04297	53,27
CRF 450 R	09-12	DMX04383	54,39
CRF 450 R	13-16	DMX04385	51,17
CRF 450 X	05-15	DMX04297	53,27
CR 500 R	89-01	DMX04173	53,69

HUSABERG	Año	Referencia	€
FE 250	2013	DMX04196	56,60
TE 250	12-13	DMX04196	56,60
TE 300	12-13	DMX04196	56,60
FE 350	2013	DMX04196	56,60
FE 450 E	09-10	DMX04198	53,13
FX 450 C	2010	DMX04198	53,13
FE 501	2013	DMX04198	53,13
FE 570 E	09-12	DMX04198	53,13

KAWASAKI	Año	Referencia	€
KX 60	99-01	DMX04186	35,21
KX 65	00-15	DMX04186	35,21
KX 80	83-00	DMX04186	35,21
KX 85	01-15	DMX04186	35,21
KX 100	95-15	DMX04186	35,21
KX 125	86-91	DMX04182	40,25
KX 125	96-97	DMX04183	54,95
KX 125	1998	DMX04184	53,41
KX 125	99-05	DMX04185	53,41
KDX 200	89-94	DMX04182	40,25
KDX 200	95-06	DMX04181	42,49
KDX 220	97-05	DMX04181	42,49
KDX 250	91-94	DMX04182	40,25
KX 250	86-91	DMX04182	40,25
KX 250	96-97	DMX04183	54,95
KX 250	1998	DMX04184	53,41
KX 250	99-07	DMX04185	53,41
KX 250 F	04-05	DMX04187	54,25
KX 250 F	06-16	DMX04290	59,57
KLX 300 R	97-07	DMX04182	40,25
KLX 450 R	08-09	DMX04290	59,57
KX 450 F	06-15	DMX04290	59,57

KTM	Año	Referencia	€
125 EXC	98-03	DMX04194	45,99
125 EXC	04-05	DMX04196	56,60
125 MXC	98-03	DMX04194	45,99
125 SX	98-03	DMX04194	45,99
125 SX	04-15	DMX04196	56,60
150 SX	09-15	DMX04196	56,60
150 XC	10-14	DMX04196	56,60
200 EXC	98-03	DMX04194	45,99
200 EXC	04-05	DMX04196	56,60
200 SX	98-03	DMX04194	45,99
200 SX	04-06	DMX04196	56,60
200 XC	06-09	DMX04196	56,60
200 XC-W	07-16	DMX04196	56,60
250 EXC	98-03	DMX04194	45,99
250 EXC Racing	2004	DMX04198	53,13
250 EXC	04-05	DMX04196	56,60
250 MXC	98-03	DMX04194	45,99
250 SX	98-02	DMX04194	45,99
250 SX	03-16	DMX04196	56,60
250 SX-F	06-15	DMX04196	56,60
250 XC	06-16	DMX04196	56,60
250 XC-F	07-15	DMX04196	56,60
250 XC-W	06-15	DMX04196	56,60
250 XCF-W	07-16	DMX04196	56,60
300 EXC	98-03	DMX04194	45,99
300 EXC	04-05	DMX04196	56,60
300 MXC	98-03	DMX04194	45,99
300 MXC	04-05	DMX04196	56,60
300 SX	98-02	DMX04194	45,99
300 XC	06-15	DMX04196	56,60
300 XC-W	06-15	DMX04196	56,60
350 SX-F	11-15	DMX04196	56,60



380 EXC	98-02	DMX04194	45,99
380 MXC	98-02	DMX04194	45,99
380 SX	98-02	DMX04194	45,99
400 EXC	00-02	DMX04195	47,25
400 EXC-G	2006	DMX04198	53,13
400 MXC	00-02	DMX04195	47,25
400 SX	00-06	DMX04195	47,25
450 EXC	2003	DMX04195	47,25
450 EXC	04-13	DMX04198	53,13
450 EXC-G	06-09	DMX04198	53,13
450 EXC-R	04-09	DMX04198	53,13
450 MXC	2003	DMX04195	47,25
450 MXC	04-05	DMX04198	53,13
450 SX	2003	DMX04195	47,25
450 SX	04-06	DMX04198	53,13
450 SX-F	07-12	DMX04196	56,60
450 XC	2007	DMX04196	56,60
450 XC-F	08-13	DMX04196	56,60
450 XC-G	2006	DMX04198	53,13
450 XC-W	07-16	DMX04198	53,13
500 EXC	12-16	DMX04198	53,13
500 XC-W	12-16	DMX04198	53,13
505 SX-F	08-09	DMX04196	56,60
505 XC-F	08-09	DMX04196	56,60
520 EXC	00-02	DMX04195	47,25
520 MXC	00-02	DMX04195	47,25
520 SX	00-02	DMX04195	47,25
525 EXC	2003	DMX04195	47,25
525 EXC	04-05	DMX04198	53,13
525 EXC-G	06-07	DMX04198	53,13
525 MXC	2003	DMX04195	47,25
525 MXC	04-05	DMX04198	53,13
525 SX	2003	DMX04195	47,25
525 SX	04-06	DMX04198	53,13
525 XC	06-07	DMX04196	56,60
525 XC-W	2007	DMX04196	56,60
530 EXC	09-11	DMX04198	53,13
530 EXC-R	08-10	DMX04198	53,13
530 XC-W	08-11	DMX04198	53,13
SUZUKI			
RM 65	03-05	DMX04186	35,21
RM 80	96-01	DMX04190	39,55
RM 85	2002	DMX04190	39,55
RM 85	03-17	DMX04192	54,11
RM 100	2003	DMX04186	35,21
DR 125	86-02	DMX04291	55,93
RM 125	96-00	DMX04188	54,81
RM 125	01-03	DMX04189	51,59

RM 125	04-07	DMX04193	54,11
DR 200	86-09	DMX04291	37,03
RM 250	96-00	DMX04188	54,81
RM 250	01-03	DMX04189	51,59
RM 250	04-08	DMX04193	54,11
RM-Z 250	04-06	DMX04187	54,25
RM-Z 250	07-09	DMX04193	54,11
RM-Z 250	10-15	DMX04197	57,19
DR-Z 400 E	00-07	DMX04191	55,93
DR-Z 400 S	00-08	DMX04191	55,93
DR-Z 400 SM	05-09	DMX04191	55,93
RM-Z 450	05-15	DMX04193	54,11
RMX 450	2010	DMX04193	54,11
YAMAHA			
YZ 80	93-98	DMX04240	41,30
YZ 80	99-01	DMX04241	41,65
YZ 85	02-16	DMX04241	41,65
YZ 125	94-97	DMX04238	53,97
YZ 125	99-01	DMX04236	57,10
YZ 125	02-04	DMX04242	58,31
YZ 125	05-16	DMX04258	62,65
WR 250	91-93	DMX04237	60,48
WR 250	94-97	DMX04238	53,97
WR 250 F	2001	DMX04236	57,10
WR 250 F	02-05	DMX04242	58,31
WR 250 F	06-13	DMX04380	60,69
YZ 250	88-92	DMX04237	60,48
YZ 250	93-97	DMX04238	53,97
YZ 250	99-01	DMX04236	57,10
YZ 250	02-04	DMX04242	58,31
YZ 250	05-14	DMX04259	58,31
YZ 250 F	2001	DMX04236	57,10
YZ 250 F	02-06	DMX04242	58,31
YZ 250 F	07-13	DMX04380	60,69
YZ 250 F	14-16	DMX04287	63,32
WR 400 F	99-00	DMX04236	57,10
YZ 400 F	1999	DMX04236	57,10
WR 426 F	2001	DMX04236	57,10
WR 426 F	2002	DMX04242	58,31
YZ 426 F	00-01	DMX04236	57,10
YZ 426 F	2002	DMX04242	58,31
WR 450 F	03-05	DMX04242	58,31
WR 450 F	06-15	DMX04380	60,69
YZ 450 F	03-05	DMX04242	58,31
YZ 450 F	06-09	DMX04380	60,69
YZ 450 F	10-16	DMX04287	63,32
WR 500 Z	92-93	DMX04237	60,48

SUSPENSIÓN / DIRECCIÓN



Control de horquilla

€
54



Retenedor de horquilla delantera para controlar la salida en carreras
Fabricado en aluminio mecanizado AL 6061-T6

HONDA	Año	Referencia
CR 80 R	96-02	DMX04004
CR 85 R	03-15	DMX04004
CR 125 R	98-15	DMX04005
CRF 150	03-15	DMX04004
CR 250 R	98-15	DMX04006
CRF 250 R	04-15	DMX04006
CRF 250 X	04-15	DMX04006
CRF 450 R	02-07	DMX04006
CRF 450 X	05-07	DMX04006

KAWASAKI	Año	Referencia
KX 80	98-00	DMX04007
KX 85	01-15	DMX04007
KX 100	98-15	DMX04007
KX 125	99-03	DMX04008
KX 125	04-10	DMX04011
KX 250	99-03	DMX04008
KX 250	04-10	DMX04011
KXF 250 F	04-05	DMX04011
KXF 250 F	07-15	DMX04015
KXF 450	07-15	DMX04008

KTM	Año	Referencia
65 SX	00-15	DMX04009
125 SX	02-15	DMX04009
200 SX	03-15	DMX04009
250 SX	02-15	DMX04009
400 SX	2002	DMX04009
450 SX	03-06	DMX04009
520 SX	2002	DMX04009

SUZUKI	Año	Referencia
RM 85	02-15	DMX04010
RM 125	01-15	DMX04011
RM 250	01-03	DMX04012
RM 250	04-06	DMX04011
RMZ 250	04-06	DMX04012
RMZ 250	07-14	DMX04020
RMZ 450	05-06	DMX04011
RMZ 450	07-14	DMX04020

YAMAHA	Año	Referencia
YZ 80	93-01	DMX04013
YZ 85	02-15	DMX04013
YZ 125	98-04	DMX04014
YZ 125	05-07	DMX04016
YZ 125	08-09	DMX04019
YZ 125	10-15	DMX04021
WR 250 F	01-15	DMX04014
YZ 250	98-04	DMX04014
YZ 250	05-07	DMX04016
YZ 250	08-09	DMX04019
YZ 250	10-14	DMX04021
YZ 250 F	98-04	DMX04014
YZ 250 F	05-07	DMX04016
YZ 250 F	08-09	DMX04019
YZ 250 F	10-15	DMX04021
WR 400 F	98-00	DMX04014
YZ 400 F	98-99	DMX04014
WR 426 F	01-02	DMX04014
YZ 426 F	00-02	DMX04014
WR 450 F	03-15	DMX04014
YZ 450 F	03-04	DMX04014
YZ 450 F	05-07	DMX04016
YZ 450 F	08-09	DMX04019
YZ 450 F	10-15	DMX04021



Sangradores de horquilla

Fabricado en aluminio AL 6061
Anodizado en diferentes colores



€
14,80

Referencia	Color		Descripción
DMX08051	PLATEADO	M5 0.8 MM	Horquillas Showa-Kayaba
DMX08052	DORADO	M4 0.7 MM	Horquillas europeas
DMX08053	NEGRO	M4 0.7 MM	Horquillas europeas

XPEED Protector horquilla neopreno

Referencia	€
DMX12039	13,64



Sangradores de horquilla mini

Fabricado en acero inoxidable mucho más resistentes.

€
15,80

Referencia	Color		Descripción
DMX08049	PLATEADO	M4 0.7 MM	Horquillas europeas



FRENOS





Pastillas freno sinterizadas

CARACTERÍSTICAS DE LAS PASTILLAS DE FRENO.

Orgánicas FF: Recomendadas para todo tipo de vehículos con conducción normal y paseo, y cualquier tipo de superficie, ya sea seca o mojada. Mezcla de Carbón Kevlar y fibras arámidas DuPont. Estas proporcionan una gran duración y poco desgaste del disco de freno, con una gran potencia de frenada.

Sinterizadas FG: Son las mejores pastillas para Off-Road. El material de alta densidad consiste en una mezcla de Cobre, Carbón, Estaño y otros elementos metálicos.

Ofrece excelente rendimiento y estabilidad en todas las temperaturas, reduce el desgaste y no hay diferencia de funcionamiento en condiciones secas o mojadas. Desgasta más el disco de freno. Recomendadas para todo tipo de terrenos: secos, barro, arena...



Orgánica



Sinterizada

Sinterizadas HH: Recomendadas para asfalto y carreras. Estas reclaman el índice más alto, H en frío y H en caliente. Estas pastillas ofrecen la máxima frenada y sin deterioro, ofreciendo la mayor seguridad de conducción. Menor desgaste al reducir la transferencia de calor aumentando al máximo la vida útil de la pastilla (en conducción en barro o arena su desgaste es considerable). No disponible para off-road.

PSYCHIC		GALFER		
Referencia	€	Referencia	€	Compuesto
		FD012B	13,52	G1054
		FD048B	15,08	G1054
DMP05080F	16,30	FD065B	10,30	G1054
		FD074B	18,72	G1054
DAT05560F	18,02	FD075E	22,88	G1396
DAT05404F	15,52	FD076E	22,88	G1396
		FD079B	18,62	G1054
		FD080B	21,01	G1054
		FD082B	23,50	G1054
		FD084B	16,85	G1054
		FD085B	22,88	G1054
E64-71971	16,45	FD086E	22,88	G1396
		FD089B	20,49	G1054
DMC05264F	19,86	FD091E	22,88	G1396
DAT05407F	17,79	FD092E	22,88	G1396
E64-51880	16,76	FD093E	22,88	G1396
		FD094E	22,88	G1396
E64-51866	16,30	FD095E	22,88	G1396
		FD097B	18,62	G1054
E64-81372	16,96	FD114E	22,88	G1396
		FD128B	20,28	G1054
		FD133B	16,12	G1054
DMC05554F	17,89	FD138E	22,88	G1396
		FD162B	16,22	G1054
DMX05286F	16,91	FD164E	22,88	G1396
DMC05553F	17,98	FD165E	22,88	G1396
		FD172ST	21,11	G1370
		FD177B	23,92	G1054
DMX05265F	21,11	FD204E	22,88	G1396
		FD223B	19,24	G1054
		FD224B	19,24	G1054
		FD225B	15,50	G1054
		FD230E	20,18	G1396
		FD252B	20,28	G1054
		FD252B	20,28	G1054
		FD254E	22,88	G1396
		FD265E	21,42	G1396
		FD266B	25,58	G1054
		FD270B	18,72	G1054
DMX05002F	16,32	FD278E	22,88	G1396
DMX05272F	21,10	FD286E	22,88	G1396
DMX05001F	16,32	FD291E	22,88	G1396
DAT05505F	14,67	FD299B	16,22	G1054
		FD362E	22,88	G1396
DMX05291F	16,91	FD364E	22,88	G1396
		FD409E	22,88	G1396
		FD441E	22,88	G1396
		FD450B	17,37	G1054
		FD456B	19,66	G1054
		FD458B	18,10	G1054



Referencia de producto terminada en: **E**

Compuesto G1396

Pastilla metálica (sinterizada). Compuesto especial para Off-Road. Muy buen comportamiento en seco y en mojado, bajo desgaste en barro y polvo. Máxima frenada.



Referencia de producto terminada en: **B**

Compuesto G1054

Pastilla semi-metálica (orgánica). Compuesto mixto para todo tipo de vehículos de mediana cilindrada. Buen comportamiento en seco y en mojado.



Referencia de producto terminada en: **ST**

Compuesto G1370

Pastilla metálica (sinterizada). Compuesto especial para todo tipo de vehículos. Muy buen comportamiento en seco y en mojado, bajo desgaste. Máxima frenada.

AJP	Año	DELANTERAS				TRASERAS			
		PSYCHIC - EMGO		GALFER		PSYCHIC - EMGO		GALFER	
		Referencia	€	Referencia	€	Referencia	€	Referencia	€
PR 4 125 Enduro	05-09			FD133B	16,12			FD223B	19,24
PR 4 125 Enduro/Pro	10-12			FD162B	16,22			FD252B	20,28
PR 4 200 Enduro/Pro	12-14			FD162B	16,22			FD252B	20,28
Enduro 250	05-08			FD133B	16,12			FD223B	19,24
PR 5 250 Enduro	09-10	DMX05286F	16,91	FD164E	22,88	E64-51880	16,76	FD093E	22,88
PR 5 250 Enduro	11-			FD409E	22,88	E64-51880	16,76	FD093E	22,88

ALFER	Año	Referencia	€	Referencia	€	Referencia	€	Referencia	€
125 VR 4T	03-	DMC05554F	16,87	FD138E	22,88	DMC05553F	17,98	FD165E	22,88
125 VR 4T No Limits	03-	DMC05554F	16,87	FD138E	22,88	DMC05553F	17,98	FD165E	22,88
250 AR	92-92			FD089B	20,49	DAT05560F	18,02	FD075E	22,88
250 AR	93-	DMC05554F	16,87	FD138E	22,88	DAT05560F	18,02	FD075E	22,88
250 VR	94-94	DMC05554F	16,87	FD138E	22,88	DAT05560F	18,02	FD075E	22,88
250 VR Enduro	95-	DMC05554F	16,87	FD138E	22,88	DMC05553F	17,98	FD165E	22,88
250 VR Motocross	95-	DMC05554F	16,87	FD138E	22,88	DMC05553F	17,98	FD165E	22,88
250 No Limits	95-	DMC05554F	16,87	FD138E	22,88	DMC05553F	17,98	FD165E	22,88

APRILIA	Año	Referencia	€	Referencia	€	Referencia	€	Referencia	€
MXV 450	07-	DMX05286F	16,91	FD164E	22,88	DMX05272F	21,10	FD286E	22,88
RXV 450	06-	DMX05286F	16,91	FD164E	22,88	DMX05272F	21,10	FD286E	22,88
RXV 550	07-	DMX05286F	16,91	FD164E	22,88	DMX05272F	21,10	FD286E	22,88

BETA	Año	Referencia	€	Referencia	€	Referencia	€	Referencia	€
125 RR 4t	06-			FD162B	16,22			FD456B	19,66
125 RR Enduro	08-			FD162B	16,22			FD456B	19,66
250 RR 4t	05-07	DMX05286F	16,91	FD164E	22,88	DMX05272F	21,10	FD456B	19,66
250 RR 2t Enduro	12-14	DMX05286F	16,91	FD164E	22,88	DMX05272F	21,10	FD456B	19,66
300 RR 2t Enduro	13-14	DMX05286F	16,91	FD164E	22,88	DMX05272F	21,10	FD456B	19,66
300 Xtrainer	15-17	DMX05286F	16,91	FD164E	22,88	DMX05272F	21,10	FD456B	19,66
350 RR 4T	11-12	DMX05286F	16,91	FD164E	22,88	DMX05272F	21,10	FD456B	19,66
350 RR 4t Enduro	13-14	DMX05286F	16,91	FD164E	22,88	DMX05272F	21,10	FD456B	19,66
350 RR Efi	15-17	DMX05286F	16,91	FD164E	22,88	DMX05272F	21,10	FD456B	19,66
390 RR 4t	15-17	DMX05286F	16,91	FD164E	22,88	DMX05272F	21,10	FD456B	19,66
400 RR 4t	05-12	DMX05286F	16,91	FD164E	22,88	DMX05272F	21,10	FD456B	19,66
400 RR 4t Enduro	13-14	DMX05286F	16,91	FD164E	22,88	DMX05272F	21,10	FD456B	19,66
430 RR 4t	15-17	DMX05286F	16,91	FD164E	22,88	DMX05272F	21,10	FD456B	19,66
450 RR 4t	05-12	DMX05286F	16,91	FD164E	22,88	DMX05272F	21,10	FD456B	19,66
450 RR 4t Enduro	13-14	DMX05286F	16,91	FD164E	22,88	DMX05272F	21,10	FD456B	19,66
480 RR 4t	15-17	DMX05286F	16,91	FD164E	22,88	DMX05272F	21,10	FD456B	19,66
498 RR 4t	12-14	DMX05286F	16,91	FD164E	22,88	DMX05272F	21,10	FD456B	19,66
498 RR 4t Enduro	13-14	DMX05286F	16,91	FD164E	22,88	DMX05272F	21,10	FD456B	19,66
525 RR 4t	05-09	DMX05286F	16,91	FD164E	22,88	DMX05272F	21,10	FD456B	19,66

BMW	Año	Referencia	€	Referencia	€	Referencia	€	Referencia	€
G 450 X	08-11	DMC05554F	16,87	FD138E	22,88	DMX05001F	16,32	FD291E	22,88
450 Sport Enduro	08-11	DMC05554F	16,87	FD138E	22,88	DMX05001F	16,32	FD291E	22,88

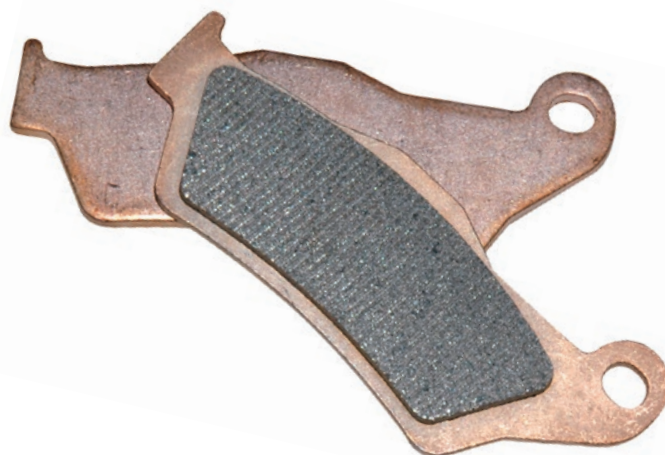

GAS GAS	DELANTERAS				TRASERAS				
	PSYCHIC - EMGO	GALFER		PSYCHIC - EMGO	GALFER				
Año	Referencia	€	Referencia	€	Referencia	€	Referencia	€	
65 MC	05-08		FD224B	19,24			FD224B	19,24	
70 EC Enducross Boy	99-		FD225B	15,50			FD225B	15,50	
Enducross 80	94	DMC05554F	16,87	FD138E	22,88		FD074B	18,72	
EC 125	94-00	DMC05554F	16,87	FD138E	22,88		FD074B	18,72	
EC 125	01-14	DMX05286F	16,91	FD138E	22,88	E64-51880	16,76	FD093E	22,88
EC 125	15-	DMX05286F	16,91	FD164E	22,88	DMX05272F	21,10	FD286E	22,88
EC 125 Six Days	11-	DMX05286F	16,91	FD164E	22,88	DMX05272F	21,10	FD286E	22,88
Enduro TT 125	93-	DMC05554F	16,87	FD138E	22,88	DAT05560F	18,02	FD075E	22,88
Enducamp 4t 125	05-		FD162B	16,22	E64-51880	16,76	FD093E	22,88	
MC 125	94-00	DMC05554F	16,87	FD138E	22,88			FD074B	18,72
MC 125	01-	DMX05286F	16,91	FD164E	22,88	E64-51880	16,76	FD093E	22,88
TT 125	95-	DMC05554F	16,87	FD138E	22,88	DMC05553F	17,98	FD165E	22,88
EC 200	99-00	DMC05554F	16,87	FD138E	22,88	DMC05553F	17,98	FD165E	22,88
EC 200	01-	DMX05286F	16,91	FD164E	22,88	E64-51880	16,76	FD093E	22,88
EC 200 Six Days	11-	DMX05286F	16,91	FD164E	22,88	DMX05272F	21,10	FD286E	22,88
EC 250	95-98	DMC05554F	16,87	FD138E	22,88	DAT05560F	18,02	FD075E	22,88
EC 250	99-00	DMC05554F	16,87	FD138E	22,88	DMC05553F	17,98	FD165E	22,88
EC 250	01-	DMX05286F	16,91	FD164E	22,88	E64-51880	16,76	FD093E	22,88
EC 250 E	11-	DMX05286F	16,91	FD164E	22,88	DMX05272F	21,10	FD286E	22,88
EC 250 F	12-15	DMX05286F	16,91	FD164E	22,88	DMX05272F	21,10	FD286E	22,88
EC 250 FSE	01-	DMX05286F	16,91	FD164E	22,88	E64-51880	16,76	FD093E	22,88
EC 250 Racing	09-	DMX05286F	16,91	FD164E	22,88	E64-51880	16,76	FD093E	22,88
EC 250 Six Days	11-	DMX05286F	16,91	FD164E	22,88	DMX05272F	21,10	FD286E	22,88
EC 250 YR	12-	DMX05286F	16,91	FD164E	22,88	DMX05272F	21,10	FD286E	22,88
FSE 250 4T	99-	DMC05554F	16,87	FD138E	22,88	DMC05553F	17,98	FD165E	22,88
MC 250	95-98	DMC05554F	16,87	FD138E	22,88	DAT05560F	18,02	FD075E	22,88
MC 250	99-00	DMC05554F	16,87	FD138E	22,88	DMC05553F	17,98	FD165E	22,88
MC 250	01-	DMX05286F	16,91	FD164E	22,88	E64-51880	16,76	FD093E	22,88
TT 250	95-	DMC05554F	16,87	FD138E	22,88	DMC05553F	17,98	FD165E	22,88
EC 300	99-00	DMC05554F	16,87	FD138E	22,88	DMC05553F	17,98	FD165E	22,88
EC 300	01-	DMX05286F	16,91	FD164E	22,88	E64-51880	16,76	FD093E	22,88
EC 300 E	11-	DMX05286F	16,91	FD164E	22,88	DMX05272F	21,10	FD286E	22,88
EC 300 F	15-	DMX05286F	16,91	FD164E	22,88	DMX05272F	21,10	FD286E	22,88
EC 300 Six Days	11-	DMX05286F	16,91	FD164E	22,88	DMX05272F	21,10	FD286E	22,88
EC 300 Racing	09-	DMX05286F	16,91	FD164E	22,88	DMX05272F	21,10	FD286E	22,88
EC 400 FSE	99-00	DMC05554F	16,87	FD138E	22,88	DMC05553F	17,98	FD165E	22,88
EC 400 FSE	01-	DMX05286F	16,91	FD164E	22,88	E64-51880	16,76	FD093E	22,88
Enducamp 400 4T	05-		FD162B	16,22	E64-51880	16,76	FD093E	22,88	
Pampera 400	06-	DMX05286F	16,91	FD164E	22,88	E64-51880	16,76	FD093E	22,88
EC 450 F	15-	DMX05286F	16,91	FD164E	22,88	DMX05272F	21,10	FD286E	22,88
EC 450 FSE	03-	DMX05286F	16,91	FD164E	22,88	E64-51880	16,76	FD093E	22,88
EC 450 RAID	15-	DMX05286F	16,91	FD164E	22,88	DMX05272F	21,10	FD286E	22,88

HM	Año	Referencia	€	Referencia	€	Referencia	€	Referencia	€
CRE F 125 X	08-			FD162B	16,22	DMX05002F	16,32	FD278E	22,88
CRE 125 R	03-	DMX05286F	16,91	FD164E	22,88	DMX05002F	16,32	FD278E	22,88
CRF 150 R / R2	08-	DAT05404F	15,52	FD076E	22,88	DMX05002F	16,32	FD278E	22,88
EASY 230 F ENDURO	04-	DMX05286F	16,91	FD164E	22,88	DMX05002F	16,32	FD278E	22,88
CRE 250 F	03-	DMX05286F	16,91	FD164E	22,88	DMX05002F	16,32	FD278E	22,88
CRF 250 R	09-	DMX05286F	16,91	FD164E	22,88	DMX05002F	16,32	FD278E	22,88
CRE 250 X	09-	DMX05286F	16,91	FD164E	22,88	DMX05002F	16,32	FD278E	22,88
CRE 300 X	09-	DMX05286F	16,91	FD164E	22,88	DMX05002F	16,32	FD278E	22,88
CRE 450 F	03-	DMX05286F	16,91	FD164E	22,88	DMX05002F	16,32	FD278E	22,88
CRE 450 R	09-	DMX05286F	16,91	FD164E	22,88	DMX05002F	16,32	FD278E	22,88
CRE 450 X	09-	DMX05286F	16,91	FD164E	22,88	DMX05002F	16,32	FD278E	22,88
CRE F 490 X	07-	DMX05286F	16,91	FD164E	22,88	DMX05002F	16,32	FD278E	22,88
CRE 500 X	09-	DMX05286F	16,91	FD164E	22,88	DMX05002F	16,32	FD278E	22,88

HONDA	Año	Referencia	€	Referencia	€	Referencia	€	Referencia	€
CR 80 R	90-96	E64-51866	15,32	FD095E	22,88	E64-51880	16,76	FD093E	22,88
CR 80 R	97-02	DAT05404F	15,52	FD076E	22,88	E64-51880	16,76	FD093E	22,88
CR 85 R	03-07	DAT05404F	15,52	FD076E	22,88	E64-51880	16,76	FD093E	22,88
CR 125 ENDURO	91-	DAT05407F	17,79	FD092E	22,88	E64-51880	16,76	FD093E	22,88
CR 125 R	87-93	DAT05407F	17,79	FD092E	22,88	E64-51880	16,76	FD093E	22,88
CR 125 R	94-01	DMX05286F	16,91	FD164E	22,88	E64-51880	16,76	FD093E	22,88
CR 125 R	02-07	DMX05286F	16,91	FD164E	22,88	DMX05002F	16,32	FD278E	22,88
CRF 150 F	03-06	DMX05286F	16,91	FD164E	22,88	DMX05251M	6,77		

		DELANTERAS				TRASERAS			
		PSYCHIC - EMGO		GALFER		PSYCHIC - EMGO		GALFER	
CRF 150 R	07-17	DAT05404F	15,52	FD076E	22,88	DMX05002F	16,32	FD278E	22,88
XLR 200 R	93-99	DMX05286F	16,91	FD164E	22,88	DMX05251M	6,77		
XR 200 R	80-02	DMX05251M	6,77			DMX05251M	6,77		
CRF 230 F	04-17	DMX05286F	16,91	FD164E	22,88	DMX05251M	6,77		
CRF 230 L	08-11	DMX05286F	16,91	FD164E	22,88	DMX05002F	16,32	FD278E	22,88
CRF 230 M	09-15	DMX05286F	16,91	FD164E	22,88	DMX05002F	16,32	FD278E	22,88
CR 250 ENDURO	91-	DAT05407F	17,79	FD092E	22,88	E64-51880	16,76	FD093E	22,88
CR 250 R	87-91	DAT05407F	17,79	FD092E	22,88	E64-51880	16,76	FD093E	22,88
CR 250 R	92-01	DMX05286F	16,91	FD164E	22,88	E64-51880	16,76	FD093E	22,88
CR 250 R	02-07	DMX05286F	16,91	FD164E	22,88	DMX05002F	16,32	FD278E	22,88
CRE 250	91-	DAT05407F	17,79	FD092E	22,88				
CRF 250 L	12-16	DMX05286F	16,91	FD164E	22,88	E64-51880	16,76	FD093E	22,88
CRF 250 R	04-17	DMX05286F	16,91	FD164E	22,88	DMX05002F	16,32	FD278E	22,88
CRF 250 X	04-17	DMX05286F	16,91	FD164E	22,88	DMX05002F	16,32	FD278E	22,88
CRF 250 XR LD	14-16	DMX05286F	16,91	FD164E	22,88	DMX05002F	16,32	FD278E	22,88
XR 250 R	88-90	DAT05407F	17,79	FD092E	22,88	DMX05268F	17,34		
XR 250 L, R	91-93	DMX05286F	16,91	FD164E	22,88	E64-51880	16,76	FD093E	22,88
XR 250 R	94-02	DMX05286F	16,91	FD164E	22,88	E64-51880	16,76	FD093E	22,88
XR 250 R	03-	DMX05286F	16,91	FD164E	22,88	DMX05002F	16,32	FD278E	22,88
XR 400 R	96-	DMX05286F	16,91	FD164E	22,88	E64-51880	16,76	FD093E	22,88
CRF 450 F	01-14	DMX05286F	16,91	FD164E	22,88	DMX05002F	16,32	FD278E	22,88
CRF 450 R	01-17	DMX05286F	16,91	FD164E	22,88	DMX05002F	16,32	FD278E	22,88
CRF 450 RALLY	13-	DMX05286F	16,91	FD164E	22,88	DMX05002F	16,32	FD278E	22,88
CRF 450 X	04-17	DMX05286F	16,91	FD164E	22,88	DMX05002F	16,32	FD278E	22,88
CRF 450 XR LD	13-	DMX05286F	16,91	FD164E	22,88	DMX05002F	16,32	FD278E	22,88
CR 500 R	85-92	DAT05407F	17,79	FD092E	22,88	E64-51880	16,76	FD093E	22,88
CR 500 R	92-00	DMX05286F	16,91	FD164E	22,88	E64-51880	16,76	FD093E	22,88
XR 600 R	87-90	DAT05407F	17,79	FD092E	22,88				
XR 600 R	91-92	DAT05407F	17,79	FD092E	22,88	E64-51880	16,76	FD093E	22,88
XR 600 R	93-	DMX05286F	16,91	FD164E	22,88	E64-51880	16,76	FD093E	22,88
XR 650 L	93-11	DMX05286F	16,91	FD164E	22,88	DMX05268F	17,34		
XR 650 R	00-	DMX05286F	16,91	FD164E	22,88	E64-51880	16,76	FD093E	22,88

HUSABERG									
	Año	Referencia	€	Referencia	€	Referencia	€	Referencia	€
125 TE	11-14	DMC05554F	16,87	FD138E	22,88	DMX05001F	16,32	FD291E	22,88
250 TE	11-14	DMC05554F	16,87	FD138E	22,88	DMX05001F	16,32	FD291E	22,88
250 FE	13-14	DMC05554F	16,87	FD138E	22,88	DMX05001F	16,32	FD291E	22,88
300 TE	11-14	DMC05554F	16,87	FD138E	22,88	DMX05001F	16,32	FD291E	22,88
350 FC	95-99	DMC05554F	16,87	FD138E	22,88	DMC05553F	17,98	FD165E	22,88
350 FE	95-99	DMC05554F	16,87	FD138E	22,88	DMC05553F	17,98	FD165E	22,88
350 FE	13-15	DMC05554F	16,87	FD138E	22,88	DMX05001F	16,32	FD291E	22,88
350 MC	91-92			FD089B	20,49	DAT05560F	18,02	FD075E	22,88
350 MC	94-			FD089B	20,49	DMC05553F	17,98	FD165E	22,88
390 FE	10-12	DMC05554F	16,87	FD138E	22,88	DMX05001F	16,32	FD291E	22,88
400 FE	00-	DMC05554F	16,87	FD138E	22,88	DMC05553F	17,98	FD165E	22,88
450 FC	04-	DMC05554F	16,87	FD138E	22,88	DMC05553F	17,98	FD165E	22,88
450 FE	04-	DMC05554F	16,87	FD138E	22,88	DMC05553F	17,98	FD165E	22,88
450 FE	12-	DMC05554F	16,87	FD138E	22,88	DMX05001F	16,32	FD291E	22,88
450 FS	04-04	DMC05655F	19,77			DMC05553F	17,98		
450 FX	10-11	DMC05554F	16,87	FD138E	22,88	DMX05001F	16,32	FD291E	22,88
500 Cross	93-93	DMC05554F	16,87	FD138E	22,88	DAT05560F	18,02	FD075E	22,88
500 MC	91-92	DMC05554F	16,87	FD138E	22,88	DAT05560F	18,02	FD075E	22,88
501 FC	95-99	DMC05554F	16,87	FD138E	22,88	DMC05553F	17,98	FD165E	22,88
501 FE	95-99	DMC05554F	16,87	FD138E	22,88	DMC05553F	17,98	FD165E	22,88
501 FE	13-14	DMC05554F	16,87	FD138E	22,88	DMX05001F	16,32	FD291E	22,88
501 MC	89-92			FD089B	20,49	DAT05560F	18,02	FD075E	22,88
501 MC	94-99			FD089B	20,49	DMC05553F	17,98	FD165E	22,88
550 FC	06-08	DMC05554F	16,87	FD138E	22,88	DMC05553F	17,98	FD165E	22,88
550 FE	06-08	DMC05554F	16,87	FD138E	22,88	DMC05553F	17,98	FD165E	22,88
570 FE	09-12	DMC05554F	16,87	FD138E	22,88	DMX05001F	16,32	FD291E	22,88
600 FC	95-99	DMC05554F	16,87	FD138E	22,88	DMC05553F	17,98	FD165E	22,88
600 FE	95-99	DMC05554F	16,87	FD138E	22,88	DMC05553F	17,98	FD165E	22,88
650 FC	04-	DMC05554F	16,87	FD138E	22,88	DMC05553F	17,98	FD165E	22,88
650 FE	04-	DMC05554F	16,87	FD138E	22,88	DMC05553F	17,98	FD165E	22,88
650 FS	03-03	DMC05655F	19,77			DMC05553F	17,98		

RUEDAS Y NEUMÁTICOS

MOTOR

ADMISIÓN / ESCAPE
REFRIGERACIÓN

ELECTRICO

SUSPENSIÓN / DIRECCIÓN

FRENOS

TRANSMISIÓN

CONTROLES Y MANDOS

CHASIS

ACCESORIOS

HUSQVARNA	Año	DELANTERAS				TRASERAS			
		PSYCHIC - EMGO		GALFER		PSYCHIC - EMGO		GALFER	
		Referencia	€	Referencia	€	Referencia	€	Referencia	€
50 CR	11-13			FD230E	20,18			FD230E	20,18
50 CR Senior Pro	05-			FD224B	19,24			FD230E	20,18
65 CR	11-13			FD265E	21,42			FD441E	22,88
85 TC 17/14	14-17			FD458B	18,10			FD441E	22,88
85 TC 19/16	14-17			FD458B	18,10			FD441E	22,88
100 TE	05-			FD224B	19,24			FD230E	20,18
125 CR	91-91			FD089B	20,49	DAT05560F	18,02	FD075E	22,88
125 CR	92-94	DAT05561F	15,82						
125 CR	94-99	DMC05554F	16,87	FD138E	22,88	DMC05553F	17,98	FD165E	22,88
125 CR	93-99	E64-71971	16,45	FD086E	22,88	DAT05560F	18,02	FD075E	22,88
125 CR	04-05	DMC05554F	16,87	FD138E	22,88	DMX05001F	16,32	FD291E	22,88
125 SM S	00-	DMC05554F	16,87	FD138E	22,88	DMC05553F	17,98	FD165E	22,88
125 SM S 4t	11-13	DMC05554F	16,87	FD138E	22,88	DMC05553F	17,98	FD165E	22,88
125 TC	14-17	DMC05554F	16,87	FD138E	22,88	DMX05001F	16,32	FD291E	22,88
125 TE 4t	11-13	DMC05554F	16,87	FD138E	22,88	DMC05553F	17,98	FD165E	22,88
125 TE	14-	DMC05554F	16,87	FD138E	22,88	DMX05001F	16,32	FD291E	22,88
125 WR	93-99	E64-71971	16,45	FD086E	22,88	DAT05560F	18,02	FD075E	22,88
125 WR	94-99	DMC05554F	16,87	FD138E	22,88	DMC05553F	17,98	FD165E	22,88
125 WR	06-11	DMC05554F	16,87	FD138E	22,88	DMX05001F	16,32	FD291E	22,88
125 WRE	94-	DMC05554F	16,87	FD138E	22,88	DMC05553F	17,98	FD165E	22,88
125 WXE	07-11			FD133B	16,12	E64-51880	16,76	FD093E	22,88
250 CR	94-03	DMC05554F	16,87	FD138E	22,88	DMC05553F	17,98	FD165E	22,88
250 CR	04-05	DMC05554F	16,87	FD138E	22,88	DMX05001F	16,32	FD291E	22,88
250 CR, WR	93-99	E64-71971	16,45	FD086E	22,88	DAT05560F	18,02	FD075E	22,88
250 FC	14-17	DMC05554F	16,87	FD138E	22,88	DMX05001F	16,32	FD291E	22,88
250 FE	14-17	DMC05554F	16,87	FD138E	22,88	DMX05001F	16,32	FD291E	22,88
250 TC	04-17	DMC05554F	16,87	FD138E	22,88	DMX05001F	16,32	FD291E	22,88
250 TE	05-17	DMC05554F	16,87	FD138E	22,88	DMX05001F	16,32	FD291E	22,88
250 TE-R	13-13	DMC05554F	16,87	FD138E	22,88	DMX05001F	16,32	FD291E	22,88
250 WR	94-00	DMC05554F	16,87	FD138E	22,88	DMC05553F	17,98	FD165E	22,88
300 TE	14-17	DMC05554F	16,87	FD138E	22,88	DMX05001F	16,32	FD291E	22,88
300 WR	09-	DMC05554F	16,87	FD138E	22,88	DMX05001F	16,32	FD291E	22,88
310 TE	09-	DMC05554F	16,87	FD138E	22,88	DMX05001F	16,32	FD291E	22,88
350 FC	14-17	DMC05554F	16,87	FD138E	22,88	DMX05001F	16,32	FD291E	22,88
350 FE	14-17	DMC05554F	16,87	FD138E	22,88	DMX05001F	16,32	FD291E	22,88
350 TE	94-99	DMC05554F	16,87	FD138E	22,88	DMC05553F	17,98	FD165E	22,88
350 TE 4t	91-94			FD089B	20,49	DAT05560F	18,02	FD075E	22,88
360 CR	92-94			FD089B	20,49	DAT05560F	18,02	FD075E	22,88
360 CR	94-99	DMC05554F	16,87	FD138E	22,88	DMC05553F	17,98	FD165E	22,88
360 WR	92-94	E64-71971	16,45	FD086E	22,88	DAT05404F	15,52	FD076E	22,88
360 WR	94-00	DMC05554F	16,87	FD138E	22,88	DMC05553F	17,98	FD165E	22,88
401 Svartpilen	15-			FD450B	17,37				
410 TE	94-00	DMC05554F	16,87	FD138E	22,88	DMC05553F	17,98	FD165E	22,88
410 TE/E	00-02	DMC05554F	16,87	FD138E	22,88	DMC05553F	17,98	FD165E	22,88
449 TE	11-13	DMC05554F	16,87	FD138E	22,88	DMX05001F	16,32	FD291E	22,88
449 TC	11-13	DMC05554F	16,87	FD138E	22,88	DMX05001F	16,32	FD291E	22,88
450 FE	14-17	DMC05554F	16,87	FD138E	22,88	DMX05001F	16,32	FD291E	22,88
450 FC	14-17	DMC05554F	16,87	FD138E	22,88	DMX05001F	16,32	FD291E	22,88
450 TC	05-10	DMC05554F	16,87	FD138E	22,88	DMX05001F	16,32	FD291E	22,88
450 TE	05-10	DMC05554F	16,87	FD138E	22,88	DMX05001F	16,32	FD291E	22,88
450 SM R	01-04	DMC05655F	19,77			DMC05553F	17,98		
501 FE	14-17	DMC05554F	16,87	FD138E	22,88	DMX05001F	16,32	FD291E	22,88
510 TC	04-05	DMC05554F	16,87	FD138E	22,88	DMX05001F	16,32	FD291E	22,88
510 TE	90-94			FD089B	20,49	DAT05560F	18,02	FD075E	22,88
510 TE	95-04	DMC05554F	16,87	FD138E	22,88	DMC05553F	17,98	FD165E	22,88
510 TE	05-10	DMC05554F	16,87	FD138E	22,88	DMX05001F	16,32	FD291E	22,88
511 TE	11-13	DMC05554F	16,87	FD138E	22,88	DMX05001F	16,32	FD291E	22,88
570 TE	00-04	DMC05554F	16,87	FD138E	22,88	DMC05553F	17,98	FD165E	22,88
570 SM R	01-04	DMC05655F	19,77			DMC05553F	17,98		
610 SM R	00-04	DMC05655F	19,77			DMC05553F	17,98		
610 TC	91-94			FD089B	20,49	DAT05560F	18,02	FD075E	22,88
610 TC	94-00	DMC05554F	16,87	FD138E	22,88	DMC05553F	17,98	FD165E	22,88
610 TE 4t	91-94			FD089B	20,49	DAT05560F	18,02	FD075E	22,88
610 TE	92-94	E64-71971	16,45	FD086E	22,88	E64-51866	15,32	FD095E	22,88
610 TE	94-	DMC05554F	16,87	FD138E	22,88	DMC05553F	17,98	FD165E	22,88
630 SM R	06-12	DMC05655F	19,77			DMX05001F	16,32		
630 TE	10-	DMC05554F	16,87	FD138E	22,88	DMC05553F	17,98	FD165E	22,88
701 Enduro	16-17					DMC05553F	17,98	FD165E	22,88

	DELANTERAS				TRASERAS				
	PSYCHIC - EMGO		GALFER		PSYCHIC - EMGO		GALFER		
KAWASAKI	Año	Referencia	€	Referencia	€	Referencia	€	Referencia	€
KX 60	94-	E64-71971	16,45	FD086E	22,88				
KX 65	00-17			FD254E	22,88	E64-51866	15,32	FD095E	22,88
KX 80	93-96	DMC05264F	19,86	FD091E	22,88	E64-81372	16,96	FD114E	22,88
KX 80 R7 KX 80-II	97-99	DMX05265F	21,11	FD204E	22,88	DAT05404F	15,52	FD076E	22,88
KX 85	00-17	DMX05265F	21,11	FD204E	22,88	DAT05404F	15,52	FD076E	22,88
KX 100	88-04			FD094E	22,88	DAT05404F	15,52	FD076E	22,88
KL 125 ENDURO	03-	DMX05286F	16,91	FD164E	22,88	DMX05272F	21,10	FD286E	22,88
KX 125	89-94	E64-71971	16,45	FD086E	22,88	E64-81372	16,96	FD114E	22,88
KX 125	95-05	DMX05286F	16,91	FD164E	22,88	E64-51880	16,76	FD093E	22,88
KLX 140 L	08-17	E64-71971	16,45	FD086E	22,88	E64-51866	15,32	FD095E	22,88
KDX 200 SR	90-	E64-71971	16,45	FD086E	22,88	E64-81372	16,96	FD114E	22,88
KDX 220	99-	DMX05286F	16,91	FD164E	22,88	E64-81372	16,96	FD114E	22,88
KDX 250 R	92-	E64-71971	16,45	FD086E	22,88	E64-81372	16,96	FD114E	22,88
KLX 250	09-	E64-71971	16,45	FD086E	22,88	E64-51880	16,76	FD093E	22,88
KLX 250 R	92-	E64-71971	16,45	FD086E	22,88	E64-81372	16,96	FD114E	22,88
KLX 250 S	05-07	DMX05286F	16,91	FD164E	22,88	E64-51880	16,76	FD093E	22,88
KLX 250 S	08-	DMX05286F	16,91	FD164E	22,88	DMX05272F	21,10	FD286E	22,88
KLX 250 SF	09-	E64-71971	16,45	FD086E	22,88	E64-51880	16,76	FD093E	22,88
KX 250	89-93	E64-71971	16,45	FD086E	22,88	E64-81372	16,96	FD114E	22,88
KX 250	94-94	DMX05286F	16,91	FD164E	22,88	E64-81372	16,96	FD114E	22,88
KX 250	95-03	DMX05286F	16,91	FD164E	22,88	E64-51880	16,76	FD093E	22,88
KX 250	04-17	DMX05286F	16,91	FD164E	22,88	DMX05272F	21,10	FD286E	22,88
KX 250 F	04-17	DMX05286F	16,91	FD164E	22,88	DMX05272F	21,10	FD286E	22,88
KXE 250 F	03-	DMX05286F	16,91	FD164E	22,88	DMX05272F	21,10	FD286E	22,88
KLX 300 R	96-07	DMX05286F	16,91	FD164E	22,88	E64-51880	16,76	FD093E	22,88
KLX 400 R	03-04	DMX05286F	16,91	FD164E	22,88	E64-51880	16,76	FD093E	22,88
KLX 450 R	07-	DMX05286F	16,91	FD164E	22,88	DMX05272F	21,10	FD286E	22,88
KX 450 F	06-17	DMX05286F	16,91	FD164E	22,88	DMX05272F	21,10	FD286E	22,88
KXE 450 F	06-	DMX05286F	16,91	FD164E	22,88	DMX05272F	21,10	FD286E	22,88
KX 500	89-93	E64-71971	16,45	FD086E	22,88	E64-81372	16,96	FD114E	22,88
KX 500	94-04	DMX05286F	16,91	FD164E	22,88	E64-81372	16,96	FD114E	22,88
KX 500	95-	DMX05286F	16,91	FD164E	22,88	E64-51880	16,76	FD093E	22,88
KLX 650 R	93-	DMX05286F	16,91	FD164E	22,88	E64-81372	16,96	FD114E	22,88
KLX 650 S	93-	DMX05286F	16,91	FD164E	22,88	E64-81372	16,96	FD114E	22,88
KTM	Año	Referencia	€	Referencia	€	Referencia	€	Referencia	€
50 Go	95-			FD084B	16,85				
50 LC Pro Senior	04-			FD230E	20,18			FD230E	20,18
50 SX	06-			FD230E	20,18			FD230E	20,18
EXC 50	99-			FD133B	16,12	DMP05080F	16,30	FD065B	10,30
60 SX	99-	DMP05080F	16,30	FD065B	10,30				
65 SX	00-01	DMP05080F	16,30	FD065B	10,30			FD048B	15,08
65 SX	02-03			FD265E	21,42			FD048B	15,08
65 SX	04-08			FD265E	21,42			FD230E	20,18
65 SX	09-			FD265E	21,42			FD265E	21,42
65 XC	08-			FD265E	21,42			FD230E	20,18
80 MX	92-01			FD012B	13,52				
85 SX	03-06			FD265E	21,42			FD265E	21,42
85 SX	07-10			FD265E	21,42			FD265E	21,42
85 SX	11-11			FD265E	21,42			FD441E	22,88
85 SX 17/14	12-			FD458B	18,10			FD441E	22,88
85 SX 19/16	13-			FD458B	18,10			FD441E	22,88
105 XC	07-			FD265E	21,42			FD265E	21,42
125 Enduro	88-91			FD074B	18,72			FD074B	18,72
125 Enduro	92-92			FD128B	20,28	DAT05560F	18,02	FD075E	22,88
125 Enduro	93-	DMC05554F	16,87	FD138E	22,88	DAT05560F	18,02	FD075E	22,88
125 EGS	95-03	DMC05554F	16,87	FD138E	22,88	DMC05553F	17,98	FD165E	22,88
125 EXC	95-03	DMC05554F	16,87	FD138E	22,88	DMC05553F	17,98	FD165E	22,88
125 EXC	04-17	DMC05554F	16,87	FD138E	22,88	DMX05001F	16,32	FD291E	22,88
125 GS	89-90			FD074B	18,72			FD074B	18,72
125 GS	91-92			FD128B	20,28	DAT05560F	18,02	FD075E	22,88
125 GS	93-93	DMC05554F	16,87	FD138E	22,88	DAT05560F	18,02	FD075E	22,88
125 GS	94-94	DMC05554F	16,87	FD138E	22,88	DMC05553F	17,98	FD165E	22,88
125 MX	89-91	DAT05560F	18,02	FD075E	22,88	DAT05560F	18,02	FD075E	22,88
125 MX	92-95	DMC05554F	16,87	FD138E	22,88	DAT05560F	18,02	FD075E	22,88
125 RS	89-			FD082B	23,50				
125 SX	93-93	DMC05554F	16,87	FD138E	22,88	DAT05560F	18,02	FD075E	22,88
125 SX	94-03	DMC05554F	16,87	FD138E	22,88	DMC05553F	17,98	FD165E	22,88

RUEDAS Y NEUMÁTICOS
MOTOR
ADMISIÓN / ESCAPE REFRIGERACIÓN
ELECTRICO
SUSPENSIÓN / DIRECCIÓN
FRENOS
TRANSMISIÓN
CONTROLES Y MANDOS
CHASIS
ACCESORIOS

		DELANTERAS				TRASERAS			
		PSYCHIC - EMGO		GALFER		PSYCHIC - EMGO		GALFER	
125 SX	04-17	DMC05554F	16,87	FD138E	22,88	DMX05001F	16,32	FD291E	22,88
144 SX	08-	DMC05554F	16,87	FD138E	22,88	DMX05001F	16,32	FD291E	22,88
150 SX 17/14	15-17			FD458B	18,10			FD441E	22,88
150 SX 19/16	15-17			FD458B	18,10			FD441E	22,88
150 XC	10-	DMC05554F	16,87	FD138E	22,88	DMX05001F	16,32	FD291E	22,88
200 EXC	98-03	DMC05554F	16,87	FD138E	22,88	DMC05553F	17,98	FD165E	22,88
200 EXC	04-17	DMC05554F	16,87	FD138E	22,88	DMX05001F	16,32	FD291E	22,88
200 EGS	99-02	DMC05554F	16,87	FD138E	22,88	DMC05553F	17,98	FD165E	22,88
200 SX	03-03	DMC05554F	16,87	FD138E	22,88	DMC05553F	17,98	FD165E	22,88
200 SX	04-17	DMC05554F	16,87	FD138E	22,88	DMX05001F	16,32	FD291E	22,88
250 EGS	93-93	DMC05554F	16,87	FD138E	22,88	DAT05560F	18,02	FD075E	22,88
250 EGS	94-	DMC05554F	16,87	FD138E	22,88	DMC05553F	17,98	FD165E	22,88
250 Enduro	88-91			FD074B	18,72			FD074B	18,72
250 Enduro	92-92			FD128B	20,28	DAT05560F	18,02	FD075E	22,88
250 Enduro	93-	DMC05554F	16,87	FD138E	22,88	DAT05560F	18,02	FD075E	22,88
250 EXC	93-93	DMC05554F	16,87	FD138E	22,88	DAT05560F	18,02	FD075E	22,88
250 EXC	94-03	DMC05554F	16,87	FD138E	22,88	DMC05553F	17,98	FD165E	22,88
250 EXC / 4t	04-17	DMC05554F	16,87	FD138E	22,88	DMX05001F	16,32	FD291E	22,88
250 F	06-	DMC05554F	16,87	FD138E	22,88	DMX05001F	16,32	FD291E	22,88
250 Freeride	13-17			FD458B	18,10			FD441E	22,88
250 GS	89-90			FD074B	18,72			FD074B	18,72
250 GS	91-92			FD128B	20,28	DAT05560F	18,02	FD075E	22,88
250 GS	93-93	DMC05554F	16,87	FD138E	22,88	DAT05560F	18,02	FD075E	22,88
250 GS	94-	DMC05554F	16,87	FD138E	22,88	DMC05553F	17,98	FD165E	22,88
250 MX	89-91	DAT05560F	18,02	FD075E	22,88	DAT05560F	18,02	FD075E	22,88
250 MX	92-92	DMC05554F	16,87	FD138E	22,88	DAT05560F	18,02	FD075E	22,88
250 MX	03-	DMC05554F	16,87	FD138E	22,88	DMC05553F	17,98	FD165E	22,88
250 SX	93-93	DMC05554F	16,87	FD138E	22,88	DAT05560F	18,02	FD075E	22,88
250 SX	94-02	DMC05554F	16,87	FD138E	22,88	DMC05553F	17,98	FD165E	22,88
250 SX	03-	DMC05554F	16,87	FD138E	22,88	DMX05001F	16,32	FD291E	22,88
250 SX F	15-17	DMC05554F	16,87	FD138E	22,88	DMX05001F	16,32	FD291E	22,88
250 XC / F / W	06-	DMC05554F	16,87	FD138E	22,88	DMX05001F	16,32	FD291E	22,88
300 Enduro	92-92			FD128B	20,28	DAT05560F	18,02	FD075E	22,88
300 Enduro	93-	DMC05554F	16,87	FD138E	22,88	DAT05560F	18,02	FD075E	22,88
300 EGS	93-03	DMC05554F	16,87	FD138E	22,88	DAT05560F	18,02	FD075E	22,88
300 EXC	03-03	DMC05554F	16,87	FD138E	22,88	DMC05553F	17,98	FD165E	22,88
300 EXC	04-	DMC05554F	16,87	FD138E	22,88	DMX05001F	16,32	FD291E	22,88
300 EXC - E	08-	DMC05554F	16,87	FD138E	22,88	DMX05001F	16,32	FD291E	22,88
300 GS	91-			FD128B	20,28	DAT05560F	18,02	FD075E	22,88
300 MXC	04-	DMC05554F	16,87	FD138E	22,88	DMX05001F	16,32	FD291E	22,88
300 SX	93-03	DMC05554F	16,87	FD138E	22,88	DAT05560F	18,02	FD075E	22,88
300 XC	93-03	DMC05554F	16,87			DAT05560F	18,02		
300 XC / W	06-	DMC05554F	16,87	FD138E	22,88	DMX05001F	16,32	FD291E	22,88
350 ECX F	12-	DMC05554F	16,87	FD138E	22,88	DMX05001F	16,32	FD291E	22,88
350 EXC LC4	94-	DMC05554F	16,87	FD138E	22,88	DMC05553F	17,98	FD165E	22,88
350 Enduro	88-			FD074B	18,72			FD074B	18,72
350 Freeride	12-17			FD458B	18,10			FD441E	22,88
350 MX	91-91	DAT05560F	18,02	FD075E	22,88	DAT05560F	18,02	FD075E	22,88
350 MX	92-	DMC05554F	16,87	FD138E	22,88	DAT05560F	18,02	FD075E	22,88
350 SX Factory	10-17	DMC05554F	16,87	FD138E	22,88	DMX05001F	16,32	FD291E	22,88
350 SX F	11-17	DMC05554F	16,87	FD138E	22,88	DMX05001F	16,32	FD291E	22,88
350 XC F	11-17	DMC05554F	16,87	FD138E	22,88	DMX05001F	16,32	FD291E	22,88
400 EXC	04-17	DMC05554F	16,87	FD138E	22,88	DMX05001F	16,32	FD291E	22,88
400 LC4 EGS	94-96	DMC05554F	16,87	FD138E	22,88	DMC05553F	17,98	FD165E	22,88
440 SX	94-	DMC05554F	16,87	FD138E	22,88	DMC05553F	17,98	FD165E	22,88
450 EXC	03-03	DMC05554F	16,87	FD138E	22,88	DMC05553F	17,98	FD165E	22,88
450 EXC	04-17	DMC05554F	16,87	FD138E	22,88	DMX05001F	16,32	FD291E	22,88
450 EXC - R	08-17	DMC05554F	16,87	FD138E	22,88	DMX05001F	16,32	FD291E	22,88
450 MXC	04-17	DMC05554F	16,87	FD138E	22,88	DMX05001F	16,32	FD291E	22,88
450 Rally	11-17	DMC05554F	16,87	FD138E	22,88	DMX05001F	16,32	FD291E	22,88
450 SX	03-17	DMC05554F	16,87	FD138E	22,88	DMX05001F	16,32	FD291E	22,88
450 SXF	07-17	DMC05554F	16,87	FD138E	22,88	DMX05001F	16,32	FD291E	22,88
450 XC	06-17	DMC05554F	16,87	FD138E	22,88	DMX05001F	16,32	FD291E	22,88
450 XC Six Days	10-17	DMC05554F	16,87	FD138E	22,88	DMX05001F	16,32	FD291E	22,88
500 EXC 4t	12-14	DMC05554F	16,87			DMX05001F	16,32		
500 EXC	14-17	DMC05554F	16,87	FD138E	22,88	DMX05001F	16,32	FD291E	22,88
500 MX	92-	DMC05554F	16,87	FD138E	22,88	DAT05560F	18,02	FD075E	22,88
500 SX	93-	DMC05554F	16,87	FD138E	22,88	DAT05560F	18,02	FD075E	22,88

RUEDAS Y NEUMÁTICOS
 MOTOR
 ADMISIÓN / ESCAPE
 REFRIGERACIÓN
 ELÉCTRICO
 SUSPENSIÓN / DIRECCIÓN
 FRENOS
 TRANSMISIÓN
 CONTROLES Y MANDOS
 CHASIS
 ACCESORIOS

		DELANTERAS				TRASERAS			
		PSYCHIC - EMGO		GALFER		PSYCHIC - EMGO		GALFER	
505 SX	07-09	DMC05554F	16,87	FD138E	22,88	DMX05001F	16,32	FD291E	22,88
505 SXF	07-09	DMC05554F	16,87			DMX05001F	16,32		
525 EXC	03-03	DMC05554F	16,87	FD138E	22,88	DMC05553F	17,98	FD165E	22,88
525 EXC	04-	DMC05554F	16,87	FD138E	22,88	DMX05001F	16,32	FD291E	22,88
525 MXC	04-	DMC05554F	16,87	FD138E	22,88	DMX05001F	16,32	FD291E	22,88
525 SX	03-03	DMC05554F	16,87	FD138E	22,88	DMC05553F	17,98	FD165E	22,88
525 SX	04-	DMC05554F	16,87	FD138E	22,88	DMX05001F	16,32	FD291E	22,88
530 EXC-R	08-10	DMC05554F	16,87	FD138E	22,88	DMX05001F	16,32	FD291E	22,88
530 XC / W	08-10	DMC05554F	16,87	FD138E	22,88	DMX05001F	16,32	FD291E	22,88
530 XC Six days	10-	DMC05554F	16,87	FD138E	22,88	DMX05001F	16,32	FD291E	22,88
600 4t GS	93-93	DMC05554F	16,87	FD138E	22,88	DAT05560F	18,02	FD075E	22,88
600 4t GS	94-	DMC05554F	16,87	FD138E	22,88	DMC05553F	17,98	FD165E	22,88
600 MX LC4	90-	DAT05560F	18,02	FD075E	22,88	DAT05560F	18,02	FD075E	22,88
620 LC4 EXC, EGS, SX	94-	DMC05554F	16,87	FD138E	22,88	DMC05553F	17,98	FD165E	22,88
625 EXC	03-	DMC05554F	16,87	FD138E	22,88	DMC05553F	17,98	FD165E	22,88
640 LC4 Enduro	99-	DMC05554F	16,87	FD138E	22,88	DMC05553F	17,98	FD165E	22,88
690 Enduro	08-			FD172ST	27,44	DMC05553F	17,98	FD165E	22,88
690 Enduro R	09-			FD172ST	27,44	DMC05553F	17,98	FD165E	22,88
950 Adventure S	03-			FD172ST	27,44	DMC05554F	16,87	FD138E	22,88
950 R Super Enduro	06-			FD172ST	27,44	DMC05554F	16,87	FD138E	22,88
990 R Super Enduro	06-			FD172ST	27,44	DMC05554F	16,87	FD138E	22,88

POLINI									
	Año	Referencia	€	Referencia	€	Referencia	€	Referencia	€
65 XP R Minicross	08-			FD224B	19,24			FD224B	19,24
100 XP 4t Cross	08-			FD224B	19,24			FD224B	19,24
100 XP 4t Racing Cross	08-			FD224B	19,24			FD224B	19,24
125 XP 4 Off Road	08-			FD224B	19,24			FD224B	19,24

RIEJU									
	Año	Referencia	€	Referencia	€	Referencia	€	Referencia	€
250 Marathon	09-	DMC05554F	16,87	FD138E	22,88	DMX05001F	16,32	FD291E	22,88
250 MRX	06-08	DMX05286F	16,91	FD164E	22,88	E64-51880	16,76	FD093E	22,88
450 Marathon 450	09-	DMC05554F	16,87	FD138E	22,88	DMX05001F	16,32	FD291E	22,88
450 MRX	05-08	DMX05286F	16,91	FD164E	22,88	E64-51880	16,76	FD093E	22,88

SCORPA									
	Año	Referencia	€	Referencia	€	Referencia	€	Referencia	€
125 T-Ride F	10-			FD409E	22,88			FD270B	18,72
250 Enduro 2.5 i	06-	DMX05286F	16,91	FD164E	22,88	E64-51880	16,76	FD093E	22,88
450 Enduro 4.5 i	06-	DMX05286F	16,91	FD164E	22,88	E64-51880	16,76	FD093E	22,88
510 Enduro 5.1 i	06-	DMX05286F	16,91	FD164E	22,88	E64-51880	16,76	FD093E	22,88

SHERCO									
	Año	Referencia	€	Referencia	€	Referencia	€	Referencia	€
125 SE 1.25 F	10-			FD162B	16,22			FD270B	18,72
250 2.5 if	09-	DMC05554F	16,87	FD138E	22,88	E64-51880	16,76	FD093E	22,88
250 SE 2.5i	12-13	DMC05554F	16,87	FD138E	22,88	DMX05001F	16,32	FD291E	22,88
250 SX 2.5 F	10-	DMC05554F	16,87	FD138E	22,88	DMX05272F	21,10	FD286E	22,88
250 SE Fork Sachs	14-17	DMC05554F	16,87	FD138E	22,88	DMX05001F	16,32	FD291E	22,88
250 SE Fork WP	14-17	DMC05554F	16,87	FD138E	22,88	DMX05001F	16,32	FD291E	22,88
250 SE-R Fork Sachs	14-17	DMC05554F	16,87	FD138E	22,88	DMX05001F	16,32	FD291E	22,88
250 SE-R Fork WP	14-17	DMC05554F	16,87	FD138E	22,88	DMX05001F	16,32	FD291E	22,88
250 SEF Fork Sachs	14-17	DMC05554F	16,87	FD138E	22,88	DMX05001F	16,32	FD291E	22,88
250 SEF Fork WP	14-17	DMC05554F	16,87	FD138E	22,88	DMX05001F	16,32	FD291E	22,88
250 SEF-R Fork Sachs	14-17	DMC05554F	16,87	FD138E	22,88	DMX05001F	16,32	FD291E	22,88
250 SEF-R Fork WP	14-17	DMC05554F	16,87	FD138E	22,88	DMX05001F	16,32	FD291E	22,88
290 X-Ride	13-14	DAT05560F	18,02			DAT05560F	18,02		
300 SE 3.0	10-11	DMC05554F	16,87	FD138E	22,88	DMX05272F	21,10	FD286E	22,88
300 SE 3.0i	12-13	DMC05554F	16,87	FD138E	22,88	DMX05001F	16,32	FD291E	22,88
300 SE Fork Sachs	14-17	DMC05554F	16,87	FD138E	22,88	DMX05001F	16,32	FD291E	22,88
300 SE Fork WP	14-17	DMC05554F	16,87	FD138E	22,88	DMX05001F	16,32	FD291E	22,88
300 SE-R Fork Sachs	14-17	DMC05554F	16,87	FD138E	22,88	DMX05001F	16,32	FD291E	22,88
300 SE-R Fork WP	14-17	DMC05554F	16,87	FD138E	22,88	DMX05001F	16,32	FD291E	22,88
300 SEF Fork Sachs	14-17	DMC05554F	16,87	FD138E	22,88	DMX05001F	16,32	FD291E	22,88
300 SEF Fork WP	14-17	DMC05554F	16,87	FD138E	22,88	DMX05001F	16,32	FD291E	22,88
300 SEF-R Fork Sachs	14-17	DMC05554F	16,87	FD138E	22,88	DMX05001F	16,32	FD291E	22,88
300 SEF-R Fork WP	14-17	DMC05554F	16,87	FD138E	22,88	DMX05001F	16,32	FD291E	22,88
450 4.5 4t	04-08	DMC05554F	16,87	FD138E	22,88	DMX05272F	21,10	FD286E	22,88
450 4.5 if	09-	DMC05554F	16,87	FD138E	22,88	E64-51880	16,76	FD093E	22,88
450 SEF Fork Sachs	15-17	DMC05554F	16,87	FD138E	22,88	DMX05001F	16,32	FD291E	22,88
450 SEF Fork WP	15-17	DMC05554F	16,87	FD138E	22,88	DMX05001F	16,32	FD291E	22,88
450 SEF-R Fork Sachs	15-17	DMC05554F	16,87	FD138E	22,88	DMX05001F	16,32	FD291E	22,88

		DELANTERAS				TRASERAS			
		PSYCHIC - EMGO		GALFER		PSYCHIC - EMGO		GALFER	
450 SEF-R Fork WP	15-17	DMC05554F	16,87	FD138E	22,88	DMX05001F	16,32	FD291E	22,88
450 SE 4.5i	12-13	DMC05554F	16,87	FD138E	22,88	DMX05001F	16,32	FD291E	22,88
510 5.1 4t	06-08	DMC05554F	16,87	FD138E	22,88	DMX05272F	21,10	FD286E	22,88
510 5.1 if	09-	DMC05554F	16,87	FD138E	22,88	E64-51880	16,76	FD093E	22,88
510 SE 5.1i	12-13	DMC05554F	16,87	FD138E	22,88	DMX05001F	16,32	FD291E	22,88

SUZUKI									
	Año	Referencia	€	Referencia	€	Referencia	€	Referencia	€
RM 65	03-			FD254E	22,88	E64-51866	15,32	FD095E	22,88
RM 80	90-95			FD094E	22,88			FD094E	22,88
RM 80	96-02			FD177B	23,88			FD094E	22,88
RM 85 / L	03-04			FD177B	23,88			FD094E	22,88
RM 85 / L	05-	DMX05265F	21,11	FD204E	22,88			FD362E	22,88
RM 125	89-95	E64-71971	16,45	FD086E	22,88	E64-81372	16,96	FD114E	22,88
RM 125	96-03	DMX05286F	16,91	FD164E	22,88	E64-51880	16,76	FD093E	22,88
RM 125	04-09	DMX05286F	16,91	FD164E	22,88	DMX05272F	21,10	FD286E	22,88
DR 250 S	90-00	E64-71971	16,45	FD086E	22,88	E64-81372	16,96	FD114E	22,88
DR-Z 250 E	01-	DMX05286F	16,91	FD164E	22,88	E64-51880	16,76	FD093E	22,88
RM 250	89-95	E64-71971	16,45	FD086E	22,88	E64-81372	16,96	FD114E	22,88
RM 250	96-12	DMX05286F	16,91	FD164E	22,88	E64-51880	16,76	FD093E	22,88
RM 250 Z	04-17	DMX05286F	16,91	FD164E	22,88	DMX05272F	21,10	FD286E	22,88
RMX 250	95-	E64-71971	16,45	FD086E	22,88	E64-81372	16,96	FD114E	22,88
DR 350 S	90-92	E64-71971	16,45	FD086E	22,88	E64-81372	16,96	FD114E	22,88
DR 350 S, SH	93-93	E64-71971	16,45	FD086E	22,88	E64-81372	16,96	FD114E	22,88
DR 350 SE	94-	E64-71971	16,45	FD086E	22,88	E64-81372	16,96	FD114E	22,88
DR-Z 400 E	00-	DMX05286F	16,91	FD164E	22,88	E64-51880	16,76	FD093E	22,88
DR-Z 400 S	00-	DMX05286F	16,91	FD164E	22,88	E64-51880	16,76	FD093E	22,88
RM 450 Z	05-17	DMX05286F	16,91	FD164E	22,88	DMX05272F	21,10	FD286E	22,88
RMX 450 Z	10-17	DMX05286F	16,91	FD164E	22,88	DMX05272F	21,10	FD286E	22,88

SWM									
	Año	Referencia	€	Referencia	€	Referencia	€	Referencia	€
RS 125 R	16-17	DMC05554F	16,87	FD138E	22,88	DMX05001F	16,32	FD291E	22,88
MC 250 S	16-17	DMC05554F	16,87	FD138E	22,88	DMX05001F	16,32	FD291E	22,88
RS 300 R	16-17	DMC05554F	16,87	FD138E	22,88	DMX05001F	16,32	FD291E	22,88
RS 340 S	16-17	DMC05554F	16,87	FD138E	22,88	DMX05001F	16,32	FD291E	22,88

TM									
	Año	Referencia	€	Referencia	€	Referencia	€	Referencia	€
80 GS, MC	90-92			FD089B	20,49	DAT05560F	18,02	FD075E	22,88
80 GS, MC	93-	DMC05554F	16,87	FD138E	22,88	DMC05553F	17,98	FD165E	22,88
80 Junior	05-	DMC05554F	16,87	FD138E	22,88	E64-51880	16,76	FD093E	22,88
85 Junior	05-	DMC05554F	16,87	FD138E	22,88	E64-51880	16,76	FD093E	22,88
85 MX	01-04	DMC05554F	16,87	FD138E	22,88	DMC05553F	17,98	FD165E	22,88
85 MX	05-12	DMC05554F	16,87	FD138E	22,88	DMX05272F	21,10	FD286E	22,88
85 MX	13-	DMX05002F	16,32	FD278E	22,88	DMX05002F	16,32	FD278E	22,88
100 Junior	05-	DMC05554F	16,87	FD138E	22,88	E64-51880	16,76	FD093E	22,88
125 Cross	00-	DMC05554F	16,87	FD138E	22,88	DMC05553F	17,98	FD165E	22,88
125 Enduro/MX	00-	DMC05554F	16,87	FD138E	22,88	DMC05553F	17,98	FD165E	22,88
125 GS, MC	90-92			FD089B	20,49	DAT05560F	18,02	FD075E	22,88
125 GS, MC	93-	DMC05554F	16,87	FD138E	22,88	DMC05553F	17,98	FD165E	22,88
125 EN	00-04	DMC05554F	16,87	FD138E	22,88	DMC05553F	17,98	FD165E	22,88
125 EN	04-17	DMC05554F	16,87	FD138E	22,88	DMX05272F	21,10	FD286E	22,88
125 MX	00-04	DMC05554F	16,87	FD138E	22,88	DMX05272F	21,10	FD286E	22,88
125 MX	05-17	DMC05554F	16,87	FD138E	22,88	DMX05272F	21,10	FD286E	22,88
144 EN	14-17	DMC05554F	16,87	FD138E	22,88	DMX05272F	21,10	FD286E	22,88
144 MX	15-17	DMC05554F	16,87	FD138E	22,88	DMX05272F	21,10	FD286E	22,88
250 Enduro 4t	00-04	DMC05554F	16,87	FD138E	22,88	DMC05553F	17,98	FD165E	22,88
250 EN	04-17	DMC05554F	16,87	FD138E	22,88	DMX05272F	21,10	FD286E	22,88
250 EN F	04-17	DMC05554F	16,87	FD138E	22,88	DMX05272F	21,10	FD286E	22,88
250 MX	05-17	DMC05554F	16,87	FD138E	22,88	DMX05272F	21,10	FD286E	22,88
250 MX F	05-17	DMC05554F	16,87	FD138E	22,88	DMX05272F	21,10	FD286E	22,88
300 Enduro 4t	01-17	DMC05554F	16,87	FD138E	22,88	DMC05553F	17,98	FD165E	22,88
300 EN	14-17	DMC05554F	16,87	FD138E	22,88	DMX05272F	21,10	FD286E	22,88
300 MX	14-17	DMC05554F	16,87	FD138E	22,88	DMX05272F	21,10	FD286E	22,88
300 MX	15-17	DMC05554F	16,87	FD138E	22,88	DMX05272F	21,10	FD286E	22,88
400 4t E/Cross	00-02	DMC05554F	16,87	FD138E	22,88	DMC05553F	17,98	FD165E	22,88
400 4t E/Cross	03-	DMC05554F	16,87	FD138E	22,88	E64-51880	16,76	FD093E	22,88
450 EN F	04-17	DMC05554F	16,87	FD138E	22,88	DMX05272F	21,10	FD286E	22,88
450 MX F	05-17	DMC05554F	16,87	FD138E	22,88	DMX05272F	21,10	FD286E	22,88
530 4t E/Cross	03-	DMC05554F	16,87	FD138E	22,88	E64-51880	16,76	FD093E	22,88
530 EN F	04-17	DMC05554F	16,87	FD138E	22,88	DMX05272F	21,10	FD286E	22,88
530 MX F	05-17	DMC05554F	16,87	FD138E	22,88	DMX05272F	21,10	FD286E	22,88

YAMAHA	Año	DELANTERAS				TRASERAS			
		PSYCHIC - EMGO		GALFER		PSYCHIC - EMGO		GALFER	
		Referencia	€	Referencia	€	Referencia	€	Referencia	€
YZ 80	93-02			FD097B	18,62	DAT05505F	14,67	FD299B	16,22
YZ 85	03-			FD097B	18,62	DAT05505F	14,67	FD299B	16,22
WR 125	90-97	E64-71971	16,45	FD086E	22,88	E64-81372	16,96	FD114E	22,88
WR 125	98-02	DMX05286F	16,91	FD164E	22,88	E64-51880	16,76	FD093E	22,88
WR 125	03-07	DMX05286F	16,91	FD164E	22,88	DMX05272F	21,10	FD286E	22,88
WR 125 R	09-			FD266B	25,58	DMC05553F	17,98	FD165E	22,88
YZ 125	08-	DMX05291F	16,91	FD364E	22,88	DMX05272F	19,96	FD286E	22,88
YZ 125	90-97	E64-71971	16,45	FD086E	22,88	E64-81372	16,96	FD114E	22,88
YZ 125	98-02	DMX05286F	16,91	FD164E	22,88	E64-51880	16,76	FD093E	22,88
YZ 125	03-07	DMX05286F	16,91	FD164E	22,88	DMX05272F	21,10	FD286E	22,88
YZ 125	08-14	DMX05291F	16,91	FD364E	22,88	DMX05272F	21,10	FD286E	22,88
WR 200 R	93-	E64-71971	16,45	FD086E	22,88	E64-81372	16,96	FD114E	22,88
TTR 230	05-15	DAT05561F	15,82			DAT05462M	7,73		
TT 250	86-92			FD080B	21,01				
WR 250	91-98	E64-71971	16,45	FD086E	22,88	E64-81372	16,96	FD114E	22,88
WR 250	99-02	DMX05286F	16,91	FD164E	22,88	E64-51880	16,76	FD093E	22,88
WR 250 F	99-02	DMX05286F	16,91	FD164E	22,88	E64-51880	16,76	FD093E	22,88
WR 250 F	03-06	DMX05286F	16,91	FD164E	22,88	DMX05272F	21,10	FD286E	22,88
WR 250 F	07-	DMX05291F	16,91	FD364E	22,88	DMX05272F	21,10	FD286E	22,88
WR 250 R	08-	DMX05286F	16,91	FD164E	22,88	DMX05272F	21,10	FD286E	22,88
WR 250 X	08-					DMX05272F	21,10	FD286E	22,88
YZ 250	92-98	E64-71971	16,45	FD086E	22,88	E64-81372	16,96	FD114E	22,88
YZ 250	99-07	DMX05286F	16,91	FD164E	22,88	E64-51880	16,76	FD093E	22,88
YZ 250	08-17	DMX05291F	16,91	FD364E	22,88	DMX05272F	21,10	FD286E	22,88
YZ 250 F	00-02	DMX05286F	16,91	FD164E	22,88	E64-51880	16,76	FD093E	22,88
YZ 250 F	03-06	DMX05286F	16,91	FD164E	22,88	DMX05272F	21,10	FD286E	22,88
YZ 250 F	07-17	DMX05291F	16,91	FD364E	22,88	DMX05272F	21,10	FD286E	22,88
TT 350	87-91			FD080B	21,01				
YZ 360	90-	E64-71971	16,45	FD086E	22,88	E64-81372	16,96	FD114E	22,88
WR 400 F	98-99	DMX05286F	16,91	FD164E	22,88	E64-51880	16,76	FD093E	22,88
YZ 400 F	98-99	DMX05286F	16,91	FD164E	22,88	E64-51880	16,76	FD093E	22,88
WR 426 F	00-02	DMX05286F	16,91	FD164E	22,88	E64-51880	16,76	FD093E	22,88
YZ 426 F	00-02	DMX05286F	16,91	FD164E	22,88	E64-51880	16,76	FD093E	22,88
WR 450 F	03-	DMX05286F	16,91	FD164E	22,88	DMX05272F	21,10	FD286E	22,88
YZ 450 F	03-07	DMX05286F	16,91	FD164E	22,88	DMX05272F	21,10	FD286E	22,88
YZ 450 F	08-17	DMX05291F	16,91	FD364E	22,88	DMX05272F	21,10	FD286E	22,88
WR 500	92-	E64-71971	16,45	FD086E	22,88	E64-81372	16,96	FD114E	22,88
TT 600	93-94	E64-71971	16,45	FD086E	22,88	E64-81372	16,96	FD114E	22,88
TT 600	95-97	DMC05554F	16,87	FD138E	22,88	DMC05553F	17,98	FD165E	22,88
TT 600 S	94-			FD079B	18,62			FD079B	18,62
TT 600 R	99-02	DMC05554F	16,87	FD138E	22,88	DMC05553F	17,98	FD165E	22,88
TT 600 RE	03-	DMC05554F	16,87	FD138E	22,88	DMC05553F	17,98	FD165E	22,88





Discos de freno

Acero inoxidable con tratamiento de calor 420.

* Discos delanteros para Husaberg, Husqvarna y KTM no incorporan agujero para sensor de velocidad



GAS GAS	Año	DELANTERO		TRASERO	
		Referencia	€	Referencia	€
EC 400 FSE	01-14			DMX05516	63,69

HM	Año	DELANTERO		TRASERO	
		Referencia	€	Referencia	€
CRE 125	03-14	DMX05529	63,69	DMX05519	62,30
CRE 250 F	03-14	DMX05529	63,69	DMX05519	62,30
CRE 250 R	03-08	DMX05529	63,69	DMX05519	62,30
CRE 250 X	09-14	DMX05529	63,69	DMX05519	62,30
CRF 250 R	09-14	DMX05529	63,69	DMX05519	62,30
CRF 250 R	15-16	DMX05578	69,87		
CRM 250 X	07-14	DMX05529	63,69	DMX05519	62,30
CRE 300 X	09-14	DMX05529	63,69	DMX05519	62,30
CRE 450 F	03-14	DMX05529	63,69	DMX05519	62,30
CRE 450 R	09-14	DMX05529	63,69	DMX05519	62,30
CRE 450 X	09-14	DMX05529	63,69	DMX05519	62,30
CRF 450 R	09-14	DMX05529	63,69	DMX05519	62,30
CRF 450 R	15-16	DMX05578	69,87		
CRMF 450 R	09-14	DMX05529	63,69	DMX05519	62,30
CRMF 450 X	09-14	DMX05529	63,69	DMX05519	62,30
CREF 490 X	07-14	DMX05529	63,69	DMX05519	62,30
CREM 490 X	07-14	DMX05529	63,69	DMX05519	62,30
CRE 500 X	09-14	DMX05529	63,69	DMX05519	62,30

HONDA	Año	DELANTERO		TRASERO	
		Referencia	€	Referencia	€
CR 80	97-02	DMX05518	53,92	DMX05500	51,10
CR 85	03-07	DMX05518	53,92	DMX05500	51,10
CR 125	02-07	DMX05529	63,69	DMX05519	62,30
CRF 230 F	03-14	DMX05549	64,45		
CRF 230 L	08-11	DMX05549	64,45	DMX05552	64,88
CRF 230 M	09-11	DMX05549	64,45	DMX05552	64,88
CR 250 R	02-07	DMX05529	63,69	DMX05519	62,30
CRF 250 R	04-14	DMX05529	63,69	DMX05519	62,30
CRF 250 R	15-16	DMX05578	70,26		
CRF 250 X	04-16	DMX05529	63,69	DMX05519	62,30
XR 250 L	91-93	DMX05549	64,45	DMX05552	64,88
XR 250 R	94-03	DMX05549	64,45	DMX05552	64,88
XR 400 R	96-04	DMX05549	64,45	DMX05552	64,88
CRF 450 R	02-14	DMX05529	63,69	DMX05519	62,30
CRF 450 R	15-16	DMX05578	70,26		
CRF 450 X	04-15	DMX05529	63,69	DMX05519	62,30
CR 500 R	92-94			DMX05501	
CR 500 R	95-00	DMX05529	63,69	DMX05501	
XR 600 R	84-90	DMX05549	64,45		
XR 600 R	91-00	DMX05549	64,45	DMX05552	64,88
XR 650 L	93-15	DMX05549	64,45	DMX05567	
XR 650 R	00-07	DMX05549	64,45	DMX05567	

HUSABERG	Año	DELANTERO		TRASERO	
		Referencia	€	Referencia	€
TE 125	11-	DMX05515*	64,45	DMX05516	63,69
FE 250	13-	DMX05515*	64,45	DMX05516	63,69
TE 250	11-	DMX05515*	64,45	DMX05516	63,69
TE 300	11-	DMX05515*	64,45	DMX05516	63,69
FE 350	13	DMX05515*	64,45	DMX05516	63,69
FE 390	10-	DMX05515*	64,45	DMX05516	63,69
FE 400	00-	DMX05515*	64,45	DMX05516	63,69

FC 450	04-	DMX05515*	64,45	DMX05516	63,69
FC 450	04-	DMX05515*	64,45	DMX05516	63,69
FE 450	12-	DMX05515*	64,45	DMX05516	63,69
FS 450	04			DMX05516	63,69
FSE 450	05-			DMX05516	63,69
FX 450	10-	DMX05515*	64,45	DMX05516	63,69
FE 501	13-	DMX05515*	64,45	DMX05516	63,69
FC 550	04-	DMX05515*	64,45	DMX05516	63,69
FE 550	04-	DMX05515*	64,45	DMX05516	63,69
FE 570	09-	DMX05515*	64,45	DMX05516	63,69
FC 650	04-	DMX05515*	64,45	DMX05516	63,69
FE 650	04-	DMX05515*	64,45	DMX05516	63,69

HUSQVARNA	Año	DELANTERO		TRASERO	
		Referencia	€	Referencia	€
125 TC	14-15	DMX05515*	64,45	DMX05516	63,69
125 TE	14-15	DMX05515*	64,45	DMX05516	63,69
250 FC	14-15	DMX05515*	64,45	DMX05516	63,69
250 FE	14-15	DMX05515*	64,45	DMX05516	63,69
250 TC	14-15	DMX05515*	64,45	DMX05516	63,69
250 TE	14-15	DMX05515*	64,45	DMX05516	63,69
350 FC	14-15	DMX05515*	64,45	DMX05516	63,69
350 FE	14-15	DMX05515*	64,45	DMX05516	63,69
450 FC	14-15	DMX05515*	64,45	DMX05516	63,69
450 FE	14-15	DMX05515*	64,45	DMX05516	63,69
501 FE	14-15	DMX05515*	64,45	DMX05516	63,69

KAWASAKI	Año	DELANTERO		TRASERO	
		Referencia	€	Referencia	€
KX 80	88-00	DMX05530	59,35	DMX05509	49,37
KX 85	01-16	DMX05533	59,35	DMX05522	49,37
KX 100	01-14	DMX05533	59,35	DMX05522	49,37
KX 125	89-02	DMX05520	67,05	DMX05521	59,02
KX 125	03-05	DMX05536	64,45	DMX05531	59,78
KX 125	06-07	DMX05539	65,86	DMX05531	59,78
KX 250	89-02	DMX05520	67,05	DMX05521	59,02
KX 250	03-05	DMX05536	64,45	DMX05531	59,78
KX 250	06-07	DMX05539	65,86	DMX05531	59,78
KX 250 F	04-05	DMX05536	64,45	DMX05531	59,78
KX 250 F	06-14	DMX05539	65,86	DMX05531	59,78
KX 250 F	15-16	DMX05576	62,92		
KLX 450 R	08-09	DMX05539	65,86	DMX05531	59,78
KX 450 F	06-14	DMX05539	65,86	DMX05531	59,78
KX 450 F	15-16	DMX05576	62,92		

KTM	Año	DELANTERO		TRASERO	
		Referencia	€	Referencia	€
EXC 125	95-03	DMX05515*	64,45	DMX05516	63,69
EGS 125	95-03	DMX05515*	64,45	DMX05516	63,69
SX 125	95-16	DMX05515*	64,45	DMX05516	63,69
SX 144	08-	DMX05515*	64,45	DMX05516	63,69
XC 150	10-15	DMX05515*	64,45	DMX05516	63,69
EGS 200	99-02	DMX05515*	64,45	DMX05516	63,69
EXC 200	98-	DMX05515*	64,45	DMX05516	63,69
SX 200	03-	DMX05515*	64,45	DMX05516	63,69
ENDURO 250	92-	DMX05515*	64,45	DMX05516	63,69
EGS 250	99-	DMX05515*	64,45	DMX05516	63,69
EXC 250 4T	03-	DMX05515*	64,45	DMX05516	63,69
EXC-F 250	2015	DMX05515*	64,45	DMX05516	63,69
GS 250	93-	DMX05515*	64,45	DMX05516	63,69



Discos de freno

Modelo	Año	Delantero	Trasero
SX 250	94-16	DMX05515*	DMX05516
SXF 250	15-16	DMX05515*	DMX05516
ENDURO 300	92-	DMX05515*	DMX05516
EXC 300	03-	DMX05515*	DMX05516
EXC-E 300	08-	DMX05515*	DMX05516
GS 300	91-		DMX05516
MXC 300	04-	DMX05515*	DMX05516
SX 300	93-03	DMX05515*	DMX05516
EGS 300	93-03	DMX05515*	DMX05516
XC 300	93-16	DMX05515*	DMX05516
XC-W 300	06-16	DMX05515*	DMX05516
EXC-F 350	12-	DMX05515*	DMX05516
MX 350	92-	DMX05515*	DMX05516
SX-F 350	11-16	DMX05515*	DMX05516
SX Factory 350	10-	DMX05515*	DMX05516
XC-F 350	11-16	DMX05515*	DMX05516
EXC 400	04-	DMX05515*	DMX05516
EXC 450	03-	DMX05515*	DMX05516
MXC 450	04-	DMX05515*	DMX05516
SX 450	03-	DMX05515*	DMX05516
SX-F 450	03-16	DMX05515*	DMX05516
XC 450	06-	DMX05515*	DMX05516
EXC 500	12-16	DMX05515*	DMX05516
MX 500	92-	DMX05515*	DMX05516
SX 500	93-	DMX05515*	DMX05516
SX 505	07-	DMX05515*	DMX05516
EXC 525	03-	DMX05515*	DMX05516
MXC 525	04-	DMX05515*	DMX05516
SX 525	03-	DMX05515*	DMX05516
EXC-R 530	08-	DMX05515*	DMX05516
XC 530	08-	DMX05515*	DMX05516
XCW 530	08-	DMX05515*	DMX05516
XC SIX DAYS 530	10-	DMX05515*	DMX05516
XC 550	94-	DMX05515*	DMX05516



SUZUKI	DELANTERO		TRASERO	
	Año	Referencia	€	Referencia
RM 85	05-16	DMX05540	57,18	DMX05541
RM 125	88-98	DMX05513	60,98	DMX05514
RM 125	99-08	DMX05513	60,98	DMX05517
DRZ 250 E	01-07	DMX05513	60,98	
RM 250	87-98	DMX05513	60,98	DMX05514
RM 250	99-08	DMX05513	60,98	DMX05517
RMZ 250	04-06	DMX05536	64,45	DMX05331
RMZ 250	07-16	DMX05537	61,09	DMX05538
RMX 250	95-98	DMX05513	60,98	DMX05514
DRZ 400	00-16	DMX05513	60,98	DMX05514
RMZ 450	05-16	DMX05537	61,09	DMX05538
RMX 450	2010	DMX05537	61,09	DMX05538

YAMAHA	DELANTERO		TRASERO	
	Año	Referencia	€	Referencia
YZ 80	93-02	DMX05535	60,09	DMX05527
YZ 85	02-16	DMX05535	60,09	DMX05527
YZ 125	2001	DMX05523	62,71	DMX05512
YZ 125	02-16	DMX05523	62,71	DMX05525
WR 250	2001	DMX05523	62,71	DMX05525
WR 250 F	2001	DMX05523	62,71	DMX05512
WR 250 F	02-12	DMX05523	62,71	DMX05525
YZ 250	2001	DMX05523	62,71	DMX05512
YZ 250	02-07	DMX05523	62,71	DMX05525
YZ 250	08-16	DMX05523	62,71	DMX05512
YZ 250 F	2001	DMX05523	62,71	DMX05512
YZ 250 F	02-15	DMX05523	62,71	DMX05525
YZ 250 F	2016	DMX05577	62,92	
WR 426 F	2001	DMX05523	62,71	DMX05512
YZ 426 F	2002	DMX05523	62,71	DMX05525
WR 450 F	03-14	DMX05523	62,71	DMX05525
YZ 450 F	03-15	DMX05523	62,71	DMX05525
YZ 450 F	2016	DMX05577	62,92	



Kit de 10 tornillos discos de freno

GAS GAS	Año	Delantero	Trasero
todas	95-13	DMX05906	DMX05906

HONDA	Año	Delantero	Trasero
CR 80	02-15	DMX05911	DMX05911
CR 85	02-15	DMX05911	DMX05911
CR 125	02-12	DMX05911	DMX05911
CRF 150	06-15	DMX05911	DMX05911
CR 250	02-12	DMX05911	DMX05911
CRF 250 R	02-15	DMX05911	DMX05911
CRF 250 X	02-15	DMX05911	DMX05911
CRF 450 R	02-15	DMX05911	DMX05911
CRF 450 X	02-15	DMX05911	DMX05911
CR 500	95-01		DMX05907

KAWASAKI	Año	Delantero	Trasero
KX 65	todas	DMX05908	DMX05908
KX 85	02-15	DMX05908	DMX05908
KX 100	89-01	DMX05906	DMX05906
KX 125	92-02	DMX05906	DMX05906
KX 125	2003	DMX05906	DMX05907
KX 125	04-15	DMX05908	DMX05907
KX 250	92-02	DMX05906	DMX05906
KX 250	2003	DMX05906	DMX05907

KX 250	04-15	DMX05908	DMX05907
KX 250 F	04-15	DMX05908	DMX05907
KLX 450	08-15	DMX05908	DMX05907
KX 450 F	04-15	DMX05908	DMX05907
KX 500	93-04	DMX05906	DMX05906

KTM	Año	Delantero	Trasero
SX 50	06-15	DMX05911	DMX05911
SX 65	01-15	DMX05906	DMX05906
SX 85	04-15	DMX05911	DMX05911
EXC (todas)	00-15	DMX05911	DMX05911
EXC-F (todas)	00-15	DMX05911	DMX05911
SX (todas)	00-15	DMX05911	DMX05911
SXF (todas)	00-15	DMX05911	DMX05911

SUZUKI	Año	Delantero	Trasero
RM 65	todas	MX-05908	
RM 80	89-01	DMX05906	
RM 85	02-15	DMX05906	DMX05906
RM 125	93-15	DMX05906	DMX05906
RM 250	93-15	DMX05906	DMX05906
RM-Z 250	04-06	DMX05908	DMX05907
RM-Z 250	07-15	DMX05913	DMX05914
RMX 450	10-15	DMX05913	DMX05914
RM-Z 450	07-15	DMX05913	DMX05914

€
7,53



DMX05906

YAMAHA	Año	Delantero	Trasero
YZ 80	93-15	DMX05906	DMX05906
YZ 85	93-15	DMX05906	DMX05906
YZ 125	90-97	DMX05906	DMX05906
YZ 125	98-15	DMX05906	DMX05910
WR 250 F	02-15	DMX05906	DMX05910
YZ 250	90-97	DMX05906	DMX05906
YZ 250	98-15	DMX05906	DMX05910
YZ 250 F	01-15	DMX05906	DMX05910
YZ 400 F	98-02	DMX05906	DMX05910
YZ 426 F	98-02	DMX05906	DMX05910
WR 450 F	02-15	DMX05906	DMX05910
YZ 450 F	03-15	DMX05906	DMX05910

RUEDAS Y NEUMÁTICOS
MOTOR
ADMISIÓN / ESCAPE REFRIGERACIÓN
ELECTRICO
SUSPENSIÓN / DIRECCIÓN
FRENOS
TRANSMISIÓN
CONTROLES Y MANDOS
CHASIS
ACCESORIOS

Kit reparación bomba de freno



HONDA	Año	DELANTERO		TRASERO	
		Referencia	€	Referencia	€
CR 80 R	96-99	DMX05605	18,48	DAT05853	21,20
CR 80 R	00-02	DMX05604	18,48	DAT05853	21,20
CR 85 R	03-07	DMX05604	18,48	DAT05853	21,20
CR 125	90-99	DMX05605	18,48	DAT05853	21,20
CR 125	00-07	DMX05604	18,48		
CRF 150 F	03-16	DMX05624	20,86		
CRF 150 R	07-17	DMX05604	18,48		
CRF 230 F	03-16	DMX05624	20,86		
CR 250	86-99	DMX05605	18,48	DAT05853	21,20
CRF 250 R	04-06	DMX05604	18,48		
CRF 250 R	07-17	DMX05623	20,46		
CRF 250 X	04-15	DMX05604	18,48		
XR 250 R	96-99	DMX05605	18,48		
XR 250 R	00-04	DMX05604	18,48		
XR 350 R	1985	DMX05605	18,48		
XR 400 R	96-99	DMX05605	18,48	DAT05853	21,20
XR 400 R	00-03	DMX05604	18,48	DAT05853	21,20
CRF 450 R	02-06	DMX05604	18,48		
CRF 450 R	07-16	DMX05623	22,48		
CRF 450 X	05-15	DMX05604	18,48		
CR 500 R	86-99	DMX05605	18,48	DAT05853	21,20
CR 500 R	00-01	DMX05604	18,48	DAT05853	21,20
XR 600 R	1985	DMX05605	18,48		
XR 600 R	93-97			DAT05853	21,20
XR 650 R	00-07	DMX05604	18,48	DAT05853	21,20

KAWASAKI	Año	DELANTERO		TRASERO	
		Referencia	€	Referencia	€
KX 80	94-96	DMX05613	18,48		
KX 80	97-00	DMX05614	17,27		
KX 85	01-16	DMX05609	18,48		
KX 100	95-96	DMX05613	18,48		
KX 100	97-00	DMX05614	17,27		
KX 100	01-16	DMX05609	18,48		
KX 125	94-96	DMX05613	18,48		
KX 125	97-99	DMX05608	22,18		
KX 125	01-05	DMX05609	18,48		
KDX 200	95-06	DMX05613	18,48		
KDX 220 R	98-05	DMX05613	18,48		
KLX 250	94-96	DMX05613	18,48		
KX 250	97-99	DMX05608	22,18		
KX 250	01-07	DMX05609	22,18		
KX 250 F	06-12	DMX05609	18,48		
KX 250 F	13-16	DMX05625	18,48		
KLX 300 R	97-07	DMX05613	18,48		
KX 450 F	06-12	DMX05609	18,48		
KX 450 F	13-16	DMX05625	18,48		
KX 500	94-96	DMX05613	18,48		
KX 500	97-03	DMX05614	17,27		
KX 500	2004	DMX05609	18,48		

KTM	Año	DELANTERO		TRASERO	
		Referencia	€	Referencia	€
125 SX	06-08	DMX05602	18,48		
125 SX	09-11	DMX05603	21,78		
125 SX	12-13	DMX05603	21,78	DMX05627	19,23
125 SX	14-16			DMX05627	19,23
144 SX	2008	DMX05602	18,48		
144 SX-F	2008	DMX05602	18,48		
150 SX	09-11	DMX05603	21,78		
150 SX	2012	DMX05603	21,78	DMX05627	19,23
150 SX	13-16			DMX05627	19,23
150 XC	2010	DMX05603	21,78		
150 XC	2011	DMX05603	21,78	DMX05627	19,23
150 XC	12-13	DMX05603	21,78		
200 EXC	2004			DMX05627	19,23

200 EXC	2005	DMX05601	18,48	DMX05627	19,23
200 EXC	06-13			DMX05627	19,23
200 SX	04-13			DMX05627	19,23
200 XC	06-09	DMX05602	18,48		
200 XC-W	04-05			DMX05627	19,23
200 XC-W	06-09	DMX05602	18,48	DMX05627	19,23
200 XC-W	10-12	DMX05603	21,78	DMX05627	19,23
200 XC-W	13-16			DMX05627	19,23
250 EXC	04-07			DMX05627	19,23
250 EXC-F	2007			DMX05627	19,23
250 SX	03-08			DMX05627	19,23
250 SX	09-13	DMX05603	21,78	DMX05627	19,23
250 SX	14-16			DMX05627	19,23
250 SX-F	03-06			DMX05627	19,23
250 SX-F	07-13	DMX05603	21,78	DMX05627	19,23
250 SX-F	14-16			DMX05627	19,23
250 SXS-F	03-08			DMX05627	19,23
250 XC	08-09	DMX05602	18,48		
250 XC	10-12	DMX05603	21,78		
250 XC	2013	DMX05603	21,78	DMX05627	19,23
250 XC	2014			DMX05627	19,23
250 XC-F	06-09	DMX05602	18,48		
250 XC-F	2011	DMX05603	21,78		
250 XC-F	12-13	DMX05603	21,78	DMX05627	19,23
250 XC-F	14-16			DMX05627	19,23
250 XC-W	06-16			DMX05627	19,23
250 XCF-W	2006			DMX05627	19,23
250 XCF-W	07-10	DMX05602	18,48	DMX05627	19,23
250 XCF-W	11-13	DMX05603	21,78	DMX05627	19,23
250 XCF-W	14-16			DMX05627	19,23
300 EXC	2004			DMX05627	19,23
300 EXC	2005	DMX05601	18,48	DMX05627	19,23
300 EXC	06-07			DMX05627	19,23
300 XC	06-09	DMX05602	18,48	DMX05627	19,23
300 XC	10-13	DMX05603	21,78	DMX05627	19,23
300 XC	2014			DMX05627	19,23
300 XC-W	06-09	DMX05602	18,48	DMX05627	19,23
300 XC-W	10-13	DMX05603	21,78	DMX05627	19,23
300 XC-W	14-16			DMX05627	19,23
350 EXC-F	2012	DMX05603	21,78		
350 EXC-F	2013	DMX05603	21,78	DMX05627	19,23
350 EXC-F	14-16			DMX05627	19,23
350 SX-F	11-13	DMX05603	21,78	DMX05627	19,23
350 SX-F	14-16			DMX05627	19,23
350 XC-F	11-13	DMX05603	21,78	DMX05627	19,23
350 XC-F	14-16			DMX05627	19,23
350 XCF-W	2012	DMX05603	21,78		
350 XCF-W	12-13	DMX05603	21,78	DMX05627	19,23
350 XCF-W	14-16			DMX05627	19,23
400 EXC Racing	2004			DMX05627	19,23
400 EXC Racing	2005	DMX05601	18,48	DMX05627	19,23
400 EXC Racing	2006			DMX05627	19,23
400 XC-W	07-09	DMX05602	18,48	DMX05627	19,23
400 XC-W	2010	DMX05603	21,78	DMX05627	19,23
450 EXC	04-06			DMX05627	19,23
450 EXC	07-09	DMX05603	21,78	DMX05627	19,23
450 EXC	10-13			DMX05627	19,23
450 EXC Racing	2005	DMX05601	18,48		
450 EXC-G Racing	2005	DMX05601	18,48		
450 SMR	2012			DMX05627	19,23



Kit reparación bomba de freno



Modelo	Año	Referencia	Precio	Modelo	Año	Referencia	Precio
450 SMS	04-13	DMX05627	19,23				
450 SX	2004	DMX05627	19,23				
450 SX	2005	DMX05601	18,48				
450 SX	2006	DMX05602	18,48				
450 SX	07-13	DMX05627	19,23				
450 SX-F	07-08	DMX05602	18,48				
450 SX-F	09-11	DMX05603	21,78				
450 SX-F	12-13	DMX05603	21,78				
450 SX-F	14-16	DMX05627	19,23				
450 SXS	2004	DMX05627	19,23				
450 SXS Racing	2005	DMX05601	18,48				
450 SXS	2006	DMX05602	18,48				
450 SXS	07-13	DMX05627	19,23				
450 XC	04-06	DMX05627	19,23				
450 XC	2007	DMX05602	18,48				
450 XC	08-13	DMX05627	19,23				
450 XC-F	08-09	DMX05602	18,48				
450 XC-F	2013	DMX05603	21,78				
450 XC-F	14-16	DMX05627	19,23				
450 XC-W	07-09	DMX05602	18,48				
450 XC-W	10-12	DMX05603	21,78				
450 XC-W	2013	DMX05603	21,78				
450 XC-W	14-16	DMX05627	19,23				
450 XCR-W	2008	DMX05602	18,48				
500 EXC	12-13	DMX05603	21,78				
500 EXC	14-16	DMX05627	19,23				
500 XC-W	12-13	DMX05603	21,78				
500 XC-W	14-16	DMX05627	19,23				
505 SX-F	2007	DMX05627	19,23				
505 SX-F	2008	DMX05602	18,48				
505 SX-F	2009	DMX05627	19,23				
505 XC-F	2007	DMX05627	19,23				
505 XC-F	2008	DMX05602	18,48				
505 XC-F	2009	DMX05627	19,23				
525 EXC Racing	2004	DMX05627	19,23				
525 EXC Racing	2005	DMX05601	18,48				
525 EXC Racing	06-07	DMX05627	19,23				
525 EXC-G Racing	2005	DMX05601	18,48				
525 SX Racing	2004	DMX05627	19,23				
525 SX Racing	2005	DMX05602	18,48				
525 SX Racing	06-07	DMX05627	19,23				
525 SX Supermoto	2005	DMX05601	18,48				
525 SXS	04-07	DMX05627	19,23				
525 XC	2007	DMX05602	18,48				
525 XCW	2007	DMX05602	18,48				
530 EXC	08-09	DMX05627	19,23				
530 EXC	10-11	DMX05603	21,78				
530 EXC-R	2008	DMX05602	18,48				
530 EXC-R	09-11	DMX05627	19,23				
530 XC-W	08-09	DMX05627	19,23				
530 XC-W	10-11	DMX05603	21,78				
530 XCR-W	2008	DMX05602	18,48				
530 XCR-W	09-11	DMX05627	19,23				
540 SXS	2006	DMX05602	18,48				
540 SXS Racing	2005	DMX05601	18,48				
625 SXC	06-07	DMX05600	18,48				
660 Rally	06-09	DMX05600	18,48				

SUZUKI	DELANTERO			TRASERO	
	Año	Referencia	€	Referencia	€
RM 80	89-01	DMX05615	18,88	DAT05853	
RM 85	05-12	DMX05610	19,80	DAT05853	
RM 85	13-16	DMX05610	19,80		
RM 125	89-95	DMX05615	18,88	DAT05853	
RM 125	96-03	DMX05611	21,12	DAT05853	
RM 125	04-08	DMX05610	19,80	DAT05853	
DR 200 SE	96-13	DMX05620	20,46		
DR-Z 250	01-07	DMX05615	18,88		
RM 250	89-95	DMX05615	18,88		
RM 250	96-00	DMX05611	21,12	DAT05853	
RM 250	01-08	DMX05610	19,80	DAT05853	
RMX 250	89-98	DMX05615	18,88		
RM-Z 250	07-16	DMX05610	19,80		
DR 350	90-99	DMX05615	18,88		
DR 350 SE	90-99	DMX05620	20,46		
DR-Z 400	00-07	DMX05611	21,12		
DR-Z 400 E	00-04	DMX05611	21,12		
DR-Z 400 E	05-07	DMX05611	21,12	DAT05853	
DR-Z 400 S	00-04	DMX05620	20,46		
DR-Z 400 S	05-12	DMX05620	20,46	DAT05853	
DR-Z 400 SM	00-04	DMX05620	20,46		
DR-Z 400 SM	05-09	DMX05620	20,46	DAT05853	
RM-Z 450	05-16	DMX05610	19,80		
RMX 450	2011	DMX05610	19,80		
DR 650 SE	96-09	DMX05621	20,86	DAT05853	

YAMAHA	DELANTERO			TRASERO	
	Año	Referencia	€	Referencia	€
YZ 80	86-96	DMX05616	18,88		
YZ 80	2001			DMX05606	17,56
YZ 85	02-04			DMX05606	17,56
YZ 85	05-09	DMX05607	17,82	DMX05606	17,56
YZ 85	10-17	DMX05607	17,82		
YZ 125	86-89	DMX05616	18,88		
YZ 125	90-95	DMX05617	18,88		
YZ 125	2001			DMX05606	17,56
YZ 125	02-07	DMX05607	17,82		
YZ 125	08-17	DMX05626	19,80		
RT 180	1998	DMX05616	18,88		
TT-R 225	99-04	DMX05616	18,88		
TT-R 230	05-14	DMX05607	17,82		
WR 250 F	2001			DMX05606	17,56
WR 250 F	02-09	DMX05607	17,82		
WR 250 Z	91-96	DMX05617	18,88		
YZ 250	86-89	DMX05616	18,88		
YZ 250	90-95	DMX05617	18,88		
YZ 250	2001			DMX05606	17,56
YZ 250	03-07	DMX05607	17,82		
YZ 250	08-17	DMX05626	19,80		
YZ 250 F	2001			DMX05606	17,56
YZ 250 F	02-06	DMX05607	17,82		
YZ 250 F	07-17	DMX05626	19,80		
YZ 250 X	2017	DMX05626	19,80		
WR 426 F	2001			DMX05606	17,56
YZ 426 F	2001			DMX05606	17,56
WR 450 F	02-09	DMX05607	17,82		
YZ 450 F	02-07	DMX05607	17,82		
YZ 450 F	08-17	DMX05626	19,80		
YZ 490	86-90	DMX05616	18,88		
WR 500	92-93	DMX05617	18,88		

RUEDAS Y NEUMÁTICOS

MOTOR

ADMISIÓN / ESCAPE
REFRIGERACIÓN

ELECTRICO

SUSPENSIÓN / DIRECCIÓN

FRENOS

TRANSMISIÓN

CONTROLES Y MANDOS

CHASIS

ACCESORIOS

XPEED Protector disco freno trasero

Protege el disco de freno de caídas y golpes. Construido en material PEHD de 15mm, el grosor le confiere una rigidez inigualable, poco peso y mucho menos deformable que el aluminio.

GAS GAS	Año	Referencia
Todas (125 a 450cc)	00-09	P9208030
HONDA	Año	Referencia
CR 125	02-07	P9264030
CR 250	02-07	P9264030
CRF 250	02-15	P9264030
CRF 450	02-15	P9264030
KAWASAKI	Año	Referencia
KX 125	03-05	P9265030
KX 250	03-07	P9265030
KX 250 F	03-13	P9265030
KX 450 F	03-13	P9265030

SUZUKI	Año	Referencia
RM 125	05-08	P9259030
RM 250	05-08	P9259030
RMZ 250	07-15	P9259030
RMX 450	2010	P9259030
RMZ 450	05-15	P9259030
YAMAHA	Año	Referencia
YZ 125	99-15	P9261030
YZ 250	99-15	P9261030
YZ 250 F	01-15	P9261030
YZ 450 F	99-15	P9261030

€
22,23



PSYCHIC Disipador temperatura freno

La mejor solución para prevenir la ebullición del líquido de frenos, de forma rápida y barata. Los amantes del supermotard, tendrán la posibilidad de aumentar la frenada sin mayores costes que esta pieza. Fabricada en aluminio AL 6061

€
22,78



Referencia	Descripción	Color
DMX05332	M10 X P1.25 Japonesas	anodizado dorado
DMX05333	M10 X P1.0 Europeas	Anodizado naranja

Sangrador de frenos



Referencia €
DUP12385 45,81



Referencia €
DUP12418 39,27

Separador de pistón pinza de freno

Referencia €
DUP12075 17,13



Separador de pistón pinza de freno

Separa de un mínimo de 6,4mm a un máximo de 58mm

Referencia €
DUP12074 58,68



TRANSMISIÓN





Corona



Piñón normal

DESARROLLO				PIÑÓN			CORONA	
HONDA	Año	Dientes Piñón-Corona	Cadena	Dientes	Referencia	Referencia	Dientes	Referencia
CR 125	87-96	13-51	114/520	12	DMX55112		47	DMX210471
CR 125	1997	12-49	112/520	13	DMX55113	DMX551134	48	DMX210481
CR 125	98-99	13-51	114/520	14	DMX55114		49	DMX210491
CR 125	00-01	13-52	114/520				50	DMX210501
CR 125	2002	13-51	114/520				51	DMX210511
CR 125	2003	13-52	116/520				52	DMX210521
CR 125	04-07	13-52	116/520	12	DMX55612		47	DMX210471
				13	DMX55613	DMX556134	48	DMX210481
				14	DMX55614	DMX556144	49	DMX210491
							50	DMX210501
							51	DMX210511
							52	DMX210521
							53	DMX210531
CRF 150 F	03-05	13-48	112/520	12	DMX32712		47	DMX210471
CRF 150 F	06-16	13-47	104/520	13	DMX32713		48	DMX210481
				14	DMX32714		49	DMX210491
				15	DMX32715		50	DMX210501
							51	DMX210511
							52	DMX210521
							53	DMX210531
CRF 150 R	07-16	15-50	120/420	12	DMX131012		49	DMX21549
				13	DMX131013		50	DMX21550
				14	DMX131014		51	DMX21551
				15	DMX131015			
CRF 230 F	03-16	13-50	110/520	12	DMX32712		47	DMX210471
				13	DMX32713		48	DMX210481
				14	DMX32714		49	DMX210491
				15	DMX32715		50	DMX210501
							51	DMX210511
							52	DMX210521
							53	DMX210531
CR 250 R	88-89	14-51	116/520				47	DMX210471
CR 250 R	90-91	14-53	116/520				48	DMX210481
CR 250 R	92-93	13-49	112/520	12	DMX56712		49	DMX210491
CR 250 R	94-95	13-49	114/520	13	DMX56713	DMX567134	50	DMX210501
CR 250 R	96-02	13-50	114/520	14	DMX56714		51	DMX210511
CR 250 R	2003	13-48	114/520				52	DMX210521
CR 250 R	2004	13-50	114/520				53	DMX210531
CR 250 R	2005	13-49	116/520					
CR 250 R	06-08	13-49	114/520					
CRF 250 R	04-10	13-51	114/520	12	DMX55612		47	DMX210471
CRF 250 R	11-16	13-49	116/520	13	DMX55613	DMX556134	48	DMX210481
CRF 250 X	04-16	14-53	116/520	14	DMX55614	DMX556144	49	DMX210491
							50	DMX210501
							51	DMX210511
							52	DMX210521
							53	DMX210531
XR 250 R	82-87	13-48		13			52	DMX24552
XR 250 R	88-89	13-48	108/520	13	DMX32712			
				14	DMX32713			
				15	DMX32714		52	DMX24552
XR 250 R	90-95	13-48	108/520	12	DMX32712		45	DMX80345
				13	DMX32713		48	DMX80348
				14	DMX32714			
				15	DMX32715			
XR 250 R	96-04	13-48	106/520	12	DMX132112		47	DMX210471
				13	DMX132113		48	DMX210481
				14	DMX132114		49	DMX210491
							50	DMX210501
							51	DMX210511
							52	DMX210521
							53	DMX210531
XR 400 R	96-04	15-45	108/520	13	DAT58713		47	DMX210471
				14	DAT58714		48	DMX210481
				15	DAT58715		49	DMX210491
							50	DMX210501
							51	DMX210511
							52	DMX210521
							53	DMX210531
CRF 450 R	02-03	13-50	114/520	13	DMX56713	DMX567134	47	DMX210471
CRF 450 R	04-16	13-48	114/520	14	DMX56714		48	DMX210481
CRF 450 X	05-16	13-51	114/520				49	DMX210491
							50	DMX210501
							51	DMX210511
							52	DMX210521
							53	DMX210531
XR 600 R	85-87	14-48	110/520				52	DMX24552
XR 600 R	88-90	14-50	112/520					



Piñones y coronas acero

Piñón racing

Hendiduras para desalajar el barro y agujeros para minimizar el peso.



KAWASAKI	DESARROLLO			PIÑÓN		NORMAL	RACING	CORONA	
	Año	Dientes Piñón-Corona	Cadena	Dientes	Referencia		Referencia	Dientes	Referencia
KX 125	94-95	12-49	110/520					45	DMX28745
KX 125	96-97	13-50	112/520					46	DMX28746
KX 125	1998	12-48	112/520	12	DMX58412			47	DMX28747
KX 125	1999	12-47	110/520	13	DMX58413		DMX584134	48	DMX28748
KX 125	00-02	12-49	110/520					49	DMX28749
KX 125	2003	13-51	110/520					50	DMX28750
KX 125	04-08	13-51	114/520					51	DMX28751
								52	DMX28752
								53	DMX28753
KDX 200	89-94	13-47	110/520					45	DMX28745
KDX 200	95-06	13-47	108/520					46	DMX28746
KDX 220	97-05	13-47	108/520	11	DMX52611			47	DMX28747
KDX 250	91-94	14-48	112/520	12	DMX52612			48	DMX28748
KX 250	87-89	14-47	114/520	13	DMX52613			49	DMX28749
KX 250	90-91	14-48	114/520	14	DMX52614			50	DMX28750
KX 250	92-93	14-49	114/520	15	DMX52615			51	DMX28751
KX 250	94-96	14-49	112/520					52	DMX28752
KX 250	97-98	13-49	114/520					53	DMX28753
								45	DMX28745
								46	DMX28746
KX 250	99-01	14-49	114/520	12	DMX56512			47	DMX28747
KX 250	02-05	13-49	114/520	13	DMX56513		DMX565134	48	DMX28748
KX 250	06-08	13-51	116/520	14	DAT50414		DMX565144	49	DMX28749
								50	DMX28750
								51	DMX28751
								52	DMX28752
								53	DMX28753
								45	DMX28745
								46	DMX28746
KX 250 F	04-05	13-48	114/520	12	DMX50712			47	DMX28747
				13	DMX50713			48	DMX28748
				14	DMX50714			49	DMX28749
				15	DMX50715			50	DMX28750
								51	DMX28751
								52	DMX28752
								53	DMX28753
								45	DMX28745
								46	DMX28746
KX 250 F	06-10	13-48	112/520	13	DMX144613			47	DMX28747
KX 250 F	11-16	13-50	114/520	14	DMX144614			48	DMX28748
								49	DMX28749
								50	DMX28750
								51	DMX28751
								52	DMX28752
								53	DMX28753
								45	DMX28745
								46	DMX28746
KX 450	06-16	13-50	114/520	13	DMX156513		DMX1565134	47	DMX28747
				14	DMX156514			48	DMX28748
								49	DMX28749
								50	DMX28750
								51	DMX28751
								52	DMX28752
								53	DMX28753
								45	DMX28745
								46	DMX28746
KX 500	87-04	14-47	114/520	11	DMX52611			47	DMX28747
				12	DMX52612			48	DMX28748
				13	DMX52613			49	DMX28749
				14	DMX52614			50	DMX28750
				15	DMX52615			51	DMX28751
								52	DMX28752
								53	DMX28753

RUEDAS Y NEUMÁTICOS

MOTOR

ADMISIÓN / ESCAPE REFRIGERACIÓN

ELECTRICO

SUSPENSIÓN / DIRECCIÓN

FRENOS

TRANSMISIÓN

CONTROLES Y MANDOS

CHASIS

ACCESORIOS

Piñones y coronas acero



KTM	Año	Dientes		PIÑÓN			CORONA	
		Piñón-Corona	Cadena	Dientes	Referencia	Referencia	Dientes	Referencia
85 SX	04-16	14-46	124/428	13	DMX190713		46	DMX89546
85 SX "rueda alta"	04-16	14-49	122/428	14	DMX190714		49	DMX89549
105 SX	07-11	14-49	118/428	15	DMX190715			
125 EXC	95-97	13-48	118/520					
125 EXC	98-99	13-50	118/520					
125 EXC	2000	14-38	118/520					
125 EXC	04-10	14-42	118/520					
125 EXC	12-16	14-50	118/520					
125 SX	95-16	13-50	118/520					
150 SX	08-14	14-50	120/520					
150 SX	2015	14-48	120/520					
150 SX	2016	13-50	118/520					
200 EXC	98-99	14-50	118/520					
200 EXC	00-11	14-42	118/520					
200 EXC	12-16		118/520					
200 SX	2002	14-45	118/520					
200 SX	03-06	14-45	112/520					
200 XC	06-10	14-48	118/520					
250 EXC	91-94	14-50	116/520					
250 EXC	96-98	14-50	118/520					
250 EXC	1999	14-50	118/520				38	DMX89738
250 EXC	00-03	15-48	118/520				39	DMX89739
250 EXC	05-11	13-40	118/520				40	DMX89740
250 EXC	12-16	14-50	118/520				41	DMX89741
250 EXC-F	07-11	14-38	118/520	12	DMX539912		42	DMX89742
250 EXC-F	12-13	14-50	118/520	13	DMX539913	DMX5399134	43	DMX89743
250 EXC-F	14-16	14-52	118/520	14	DMX539914	DMX5399144	44	DMX89744
250 SX	1995	13-50	118/520	15	DMX539915	DMX5399154	45	DMX89745
250 SX	97-03	14-50	118/520				46	DMX89746
250 SX	04-15	13-48	116/520				47	DMX89747
250 SX-F	06-12	13-48	116/520				48	DMX89748
250 SX-F	13-16	13-50	118/520				49	DMX89749
250 XC	07-14	14-50	114/520				50	DMX89750
250 XC	15-16	13-50	114/520				51	DMX89751
250 XC-F	07-09	13-48	118/520				52	DMX89752
250 XC-F	12-16	13-50	118/520					
250 XC-W	10-16	13-50	118/520					
250 XCF-W	10-11	13-52	118/520					
250 XCF-W	12-15	13-50	118/520					
250 XCF-W	2016	13-52	118/520					
300 EXC	90-95	14-50	116/520					
300 EXC	95-97	14-50	118/520					
300 EXC	1998	14-52	118/520					
300 EXC	1999	14-50	118/520					
300 EXC	00-03	15-48	118/520					
300 EXC	2004	13-42	118/520					
300 EXC	05-11	13-40	116/520					
300 EXC	12-16	14-50	118/520					
350 EXC-F	12-16	14-52	118/520					
350 SX-F	11-16	14-50	118/520					
400 EXC	00-02	15-48	118/520					
400 EXC Enduro Racing	01-02	14-50	118/520					
450 EXC Enduro Racing	03-12	15-45	118/520					
450 EXC Enduro Racing	13-16	14-52	118/520					
450 SX-F	07-12	14-52	116/520					
450 SX-F	13-15	14-50	118/520					
450 SX-F	2016	13-48	118/520					



Piñón normal



Piñón racing



Piñones y coronas acero



SUZUKI	Año	DESARROLLO		PIÑÓN		CORONA		
		Dientes Piñón-Corona	Cadena	Dientes	Referencia	Referencia	Dientes	Referencia
RM 125	88-91	13-51	118/520	11			46	DMX808461
RM 125	92-96	12-49	114/520	12	DMX42711		47	DMX808471
RM 125	97-99	12-50	114/520	13	DMX42712	DMX427124	48	DMX808481
RM 125	00-05	12-49	114/520	14	DMX42713		49	DMX808491
RM 125	06-12	12-51	114/520		DMX42714		50	DMX808501
							51	DMX808511
							52	DMX808521
							53	DMX808531
RM 250	87-88	13-50	116/520				46	DMX808461
RM 250	89-97	13-49	116/520	13	DAT03229	DAT032294	47	DMX808471
RM 250	1998	13-50	114/520	14	DAT03230		48	DMX808481
RM 250	1999	13-49	114/520	15	DAT03231		49	DMX808491
RM 250	00-03	13-48	114/520				50	DMX808501
RM 250	04-12	13-50	114/520				51	DMX808511
							52	DMX808521
							53	DMX808531
RMZ 250	04-06	13-48	114/520	12	DMX50712		45	DMX28745
				13	DMX50713		46	DMX28746
				14	DMX50714		47	DMX28747
				15	DMX50715		48	DMX28748
							49	DMX28749
							50	DMX28750
							51	DMX28751
							52	DMX28752
							53	DMX28753
RMZ 250	07-09	12-48	112/520	11	DMX42711		46	DMX808461
RMZ 250	10-12	13-49	114/520	12	DMX42712	DMX427124	47	DMX808471
				13	DMX42713		48	DMX808481
				14	DMX42714		49	DMX808491
							50	DMX808501
							51	DMX808511
							52	DMX808521
							53	DMX808531
RMZ 250	13-16	13-49		13	DMX144213		46	DMX808461
				14	DMX144214		47	DMX808471
				15	DMX144215		48	DMX808481
							49	DMX808491
							50	DMX808501
							51	DMX808511
							52	DMX808521
							53	DMX808531
RMZ 450	05-07	14-49	116/520	13	DMX144113	DMX1441134	46	DMX808461
RMZ 450	08-12	13-50	114/520	14	DMX144114		47	DMX808471
RMX450	10-13	13-51	114/520	15	DMX144115		48	DMX808481
							49	DMX808491
							50	DMX808501
							51	DMX808511
							52	DMX808521
							53	DMX808531
RMZ 450	13-16	13-50	114/520	13	DMX144313		48	DMX808481
				14	DMX144314		49	DMX808491
				15	DMX144315		50	DMX808501
							51	DMX808511
							52	DMX808521
							53	DMX808531





YAMAHA	DESARROLLO			PIÑÓN		NORMAL	RACING	CORONA	
	Año	Dientes Piñón-Corona	Cadena	Dientes	Referencia	Referencia	Dientes	Referencia	
TTR 125	00-01	13-49	116/428	13 14	DMX54813 DMX54814			49 50	DMX83349 DMX184349 DMX184350
TTR 125 E	02-10	13-49	116/428	13	DMX54813			51	DMX184351
TTR 125 L	05-16	13-54	122/428	14	DMX54814			52 53 54	DMX184352 DMX184353 DMX184354
YZ 125	1988	13-49	112/520	12	DMX56312			46 47	DMX85346 DMX85347
YZ 125	89-92	13-51	116/520	13	DMX56313			48	DMX85348
YZ 125	93-96	13-50	116/520	14	DMX56314			49	DMX85349
YZ 125	97-98	13-48	112/520	15	DMX56315			50 51 52 53	DMX85350 DMX85351 DMX85352 DMX85353
YZ 125	99-01	13-48	112/520	12	DMX56312			48	DMX25148
YZ 125	02-04	13-49	112/520	13	DMX56313			49	DMX25149
				14	DMX56314			50	DMX25150
				15	DMX56315			51	DMX25151
YZ 125	05-16	13-48	112/520	13	DMX50613	DMX1590134		48	DMX25148
				14	DMX50614			49	DMX25149
								50	DMX25150
								51	DMX25151
TTR 230	05-16	13-49	106/520	12	DAT56912			48	DMX25148
				13	DAT56913			49	DMX25149
				14	DAT56914			50	DMX25150
								51	DMX25151
WR 250	1989	14-49	114/520					46	DMX85346
WR 250	1990	14-51	116/520	11	DMX52611			47	DMX85347
WR 250	91-92	14-52	116/520	12	DMX52612			48	DMX85348
WR 250	1993	14-51	116/520	13	DMX52613			49	DMX85349
WR 250	1994	14-52	116/520	14	DMX52614			50	DMX85350
WR 250	1995	15-52	116/520	15	DMX52615			51	DMX85351
WR 250	1996	14-52	116/520	16	DMX52616			52	DMX85352
WR 250	1997	14-49	112/520					53	DMX85353
WR 250	1998	14-48	112/520						
WR 250 F	99-00	14-50	114/520	12	DMX56512			48	DMX25148
				13	DMX56513	DMX565134		49	DMX25149
				14	DAT50414	DMX565144		50	DMX25150
								51	DMX25151
								47	DMX25147
WR 250 F	01-06	13-52	114/520	13	DMX50613	DMX1590134		48	DMX25148
WR 250 F	07-10	13-50	114/520	14	DMX50614			49	DMX25149
WR 250 F	10-14	14-47	114/520					50	DMX25150
WR 250 F	15-16	13-50	114/520					51	DMX25151
								52	DMX24552
								53	DMX24553
YZ 250	1979	14-48	108/520						
YZ 250	1980	14-48	106/520						
YZ 250	1981	14-48	110/520	11	DMX52611			46	DMX85346
YZ 250	82-84	13-48	112/520	12	DMX52612			47	DMX85347
YZ 250	85-86	14-50	114/520	13	DMX52613			48	DMX85348
YZ 250	87-89	14-49	114/520	14	DMX52614			49	DMX85349
YZ 250	90-91	14-51	116/520	15	DMX52615			50	DMX85350
YZ 250	1992	14-49	116/520	16	DMX52616			51	DMX85351
YZ 250	1993	14-51	116/520					52	DMX85352
YZ 250	94-97	13-49	114/520					53	DMX85353
YZ 250	1998	13-50	114/520						
YZ 250	99-01	14-50	114/520	12	DMX56512			48	DMX25148
YZ 250	02-04	14-49	114/520	13	DMX56513	DMX565134		49	DMX25149
YZ 250	05-16	14-50	114/520	14	DAT50414	DMX565144		50	DMX25150
								51	DMX25151
YZ 250 F	01-04	13-48	112/520					48	DMX25148
YZ 250 F	05-09	13-49	112/520	13	DMX50613	DMX1590134		49	DMX25149
YZ 250 F	10-13	13-51	114/520	14	DMX50614			50	DMX25150
YZ 250 F	14-16	13-50	114/520					51	DMX25151
WR 426 F	01-02	14-50	114/520						
YZ 426 F	00-02	14-48	114/520					47	DMX25147
WR 450 F	03-06	14-50	114/520					48	DMX25148
WR 450 F	07-09	13-50	114/520	12	DMX56512			49	DMX25149
WR 450 F	10-15	14-47	114/520	13	DMX56513	DMX565134		50	DMX25150
YZ 450 F	03-04	14-48	114/520	14	DAT50414	DMX565144		51	DMX25151
YZ 450 F	05-06	14-51	114/520					52	DMX24552
YZ 450 F	07-14	13-49	114/520					53	DMX24553
YZ 450 F	15-16	13-48	114/520						

ČZ Chains Cadenas

La cadena se sirve con enganche de clip.

Cadenas reforzadas sin retenes

Gama fabricada con recubrimiento CRK con composición de carburo para los bulones, aumentando su resistencia al desgaste. Incorporan casquillos KSJ para obtener una extensión inicial casi a cero y una larga duración.



Clip

Remache



420

Gama Reforzada sin retenes, hasta 85cc
Carga Rotura a partir de 22,000 Newtons

Referencia	Eslabones	€
Z42110	110	29,22
Z42130	130	33,72
Z42001	Remache	1,32
Z42002	Clip	1,45



428

Gama Reforzada sin retenes, hasta 150cc
Carga Rotura a partir de 23.000 Newtons

Referencia	Eslabones	€
Z43110	110	33,5
Z43120	120	36,30
Z43122	122	37,00
Z43001	Remache	1,32
Z43002	Clip	1,65



520 M

Gama Reforzada sin retenes, hasta 450cc
Carga Rotura a partir de 35,000 Newtons

Referencia	Eslabones	€
Z59116	116	45,28
Z59120	120	46,70
Z59001	Remache	1,58
Z59002	Clip	2,42



520 H

Gama Reforzada sin retenes, hasta 675cc
Carga Rotura a partir de 36,800 Newtons

Referencia	Eslabones	€
Z52110	110	42,11
Z52112	112	42,76
Z52114	114	43,42
Z52116	116	44,08
Z52001	Remache	1,91
Z52002	Clip	2,79



520 MX

Gama Reforzada sin retenes, hasta 450cc
Carga Rotura a partir de 35,800 Newtons

Referencia	Eslabones	€
Z58112	112	75,33
Z58114	114	76,62
Z58116	116	77,91
Z58118	118	79,20
Z58001	Remache	3,82
Z58002	Clip	5,79

Cadenas reforzadas con retenes

La cadena ORM esta fabricada con aros activos (Active-ring) Con este sistema de sellado se consigue una larga duración y una mínima extensión inicial.



428 OR

Gama Reforzada con retenes, hasta 425cc
Carga Rotura a partir de 23,400 Newtons

Referencia	Eslabones	€
Z44110	110	43,74
Z44120	120	47,42
Z44001	Remache	1,91
Z44002	Clip	2,11



520 ORM

Gama Reforzada con retenes, hasta 700cc
Carga Rotura a partir de 34,000 Newtons

Referencia	Eslabones	€
Z53110	110	63,59
Z53112	112	64,65
Z53114	114	65,73
Z53116	116	66,80
Z53118	118	67,88
Z53120	120	68,95
Z53001	Remache	2,02
Z53002	Clip	3,10



520 ORMX

Gama Reforzada con retenes, hasta 600cc
Carga Rotura a partir de 34,500 Newtons

Referencia	Eslabones	€
Z57112	112	118,17
Z57114	114	120,21
Z57116	116	122,26
Z57118	118	124,31
Z57001	Remache	4,15
Z57002	Clip	6,22

PSYCHIC Rodillos cadena

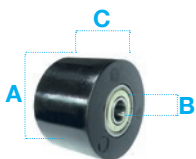

Referencia	Tipo	A	B	C	€
DMC030394	B	32	6	29	5,61
DMC030397	B	32	8	29	6,75
DMC030398	B	42	8	29	6,87
DMC030396	A	35	8	19	6,98
DMC030399	D	39	8	23	7,56
DMC0303911	C	38	8	23	8,31
DMC0303910	B	32	8	23	7,82
DMC0303912	B	32	8	23,5	8,31
DMC0303913	B	42	8	23,5	8,31



XPEED Limpiador de cadena

Referencia	€
DUP12226	9,10



XPEED Mini corta cadenas

Referencia	€
E84-56430	23,16





DMX03162



DMX03160

€
18,72



Patinador de cadena

Fabricado con poliuretano TPU (Termoplástico Premium Ultraresistente) La mejor protección al desgaste para su basculante.

HONDA

Año	Referencia
10-13	DMX03155
14-17	DMX03159
09-12	DMX03155
13-16	DMX03159

HUSQVARNA

Año	Referencia
14-17	DMX03160
14-17	DMX03160
14-17	DMX03160
14-17	DMX03160

KAWASAKI

Año	Referencia
09-16	DMX03161
09-15	DMX03161

KTM

Año	Referencia
2011	DMX03160
2011	DMX03160
2011	DMX03160
2011	DMX03160
2011	DMX03160
2011	DMX03160
2011	DMX03160
2011	DMX03160
11-17	DMX03160

SUZUKI

Año	Referencia
01-05	DMX03164
01-05	DMX03164
01-09	DMX03164
10-16	DMX03163
05-16	DMX03163
05-11	DMX03164

YAMAHA

Año	Referencia
05-17	DMX03162
02-14	DMX03162
05-17	DMX03162
02-18	DMX03162
02-15	DMX03162
02-08	DMX03162



DMX03431



DMX03432



Protector de cadena

Fabricado con poliuretano TPU (Termoplástico Premium Ultraresistente) La mejor protección para su cadena y muy resistente al desgaste.

HONDA

Año	Referencia	€
07-16	DMX03429	15,63
07-09	DMX03429	15,63
10-16	DMX03429	15,63
07-16	DMX03429	15,63
08-16	DMX03429	15,63

KAWASAKI

Año	Referencia	€
09-14	DMX03430	15,63
15-16	DMX03430	15,63
09-16	DMX03430	15,63

SUZUKI

Año	Referencia	€
99-08	DMX03432	19,69
99-08	DMX03432	19,69
2007	DMX03432	19,69
08-16	DMX03432	19,69
00-04	DMX03432	19,69
00-07	DMX03432	19,69
00-16	DMX03432	19,69
05-15	DMX03432	19,69
10-11	DMX03432	19,69
05-16	DMX03432	19,69

YAMAHA

Año	Referencia	€
97-02	DMX03432	19,69
03-14	DMX03431	17,77
15-16	DMX03431	17,77
97-02	DMX03432	19,69
07-14	DMX03431	17,77
15-16	DMX03431	17,77
99-02	DMX03432	19,69
07-16	DMX03431	17,77
1997	DMX03432	19,69
98-02	DMX03432	19,69
07-14	DMX03431	17,77
15-16	DMX03431	17,77
01-02	DMX03432	19,69
97-02	DMX03432	19,69
07-14	DMX03431	17,77
15-16	DMX03431	17,77
1997	DMX03432	19,69
98-02	DMX03432	19,69
07-14	DMX03431	17,77
15-16	DMX03431	17,77



Protector piñón

HONDA	Año	Referencia
CRF 150 R	07-15	DMX03400
XR 250 BAJA	95-02	DMX03403
XR 250 MOTARD	03-07	DMX03403
CRM 250 R	91-98	DMX03402
CRM 250 AR	91-98	DMX03402
CR 250 R	02-07	DMX03401
CRF 250 R	04-09	DMX03401
CRF 250 R	10-15	DMX03440
CRF 250 X	04-15	DMX03401
CRF 450 R	05-07	DMX03400
CRF 450 R	2008	DMX03401
CRF 450 R	09-15	DMX03440
CRF 450 X	05-15	DMX03400

KAWASAKI	Año	Referencia
KX 125	03-08	DMX03408
D-TRACKER	98-14	DMX03411
KX 250	05-08	DMX03408
KX 250 F	04-15	DMX03409
KLX 250 ES	93-10	DMX03411
KLX 250 SR	93-10	DMX03411
KX 450 F	06-14	DMX03408
KLX 450 R	08-09	DMX03410

SUZUKI	Año	Referencia
RM 125	03-09	DMX03412
RM 250	99-09	DMX03412
RMZ 250	04-06	DMX03409
RMZ 250	07-15	DMX03404
DRZ 400 S	00-13	DMX03413
DRZ 400S M	00-13	DMX03413
RMZ 450	05-15	DMX03404

YAMAHA	Año	Referencia
YZ 125	05-15	DMX03401
YZ 250	99-15	DMX03404
YZ 250 F	01-13	DMX03404
WR 250 F	01-10	DMX03404
WR 250 R	07-09	DMX03406
WR 250 X	07-09	DMX03406
TRICKER 250	04-09	DMX03407
XT 250 X	06-09	DMX03407
SEROW 250	05-09	DMX03407
YZ 450 F	03-13	DMX03405
WR 450 F	03-13	DMX03405

€
27



Protege el piñón y la cadena de interferencias externas. Su diseño ofrece una visión rápida del piñón.

Fabricado en aluminio y anodizado en dorado.



Protector de cadena

Construido en aluminio con el interior de plástico anti-desgaste. Anodizado en dorado.



€
42

HONDA	Año	Referencia
CR 125	90-04	DMX03416
CR 125	05-10	DMX03415
CR 250 R	90-04	DMX03416
CR 250 R	05-09	DMX03415
CRF 250	02-04	DMX03416
CRF 250	05-06	DMX03415
CRF 250	07-14	DMX03414
CRF 450 R	02-04	DMX03416
CRF 450 R	05-14	DMX03414
CRF 450 X	02-04	DMX03416
CRF 450 X	05-14	DMX03414

KAWASAKI	Año	Referencia
KX 125	97-06	DMX03419
KLX 150	09-14	DMX03425
KD 220	Todas	DMX03421
KX 250	97-07	DMX03419
KX 250 F	04-05	DMX03419
KX 250 F	06-08	DMX03420
KX 250 F	09-12	DMX03424
KX 450 F	06-08	DMX03420
KX 450 F	09-12	DMX03424
KLX 450 R	08-10	DMX03419

KTM	Año	Referencia
125 Todas	98-06	DMX03422
250 Todas	94-97	DMX03422
300 Todas	94-95	DMX03422
360 Todas	96-97	DMX03422
380 Todas	98-06	DMX03422
EXC	08-14	DMX03427
SX	2007	DMX03427
SX	08-14	DMX03426
SX-F	2007	DMX03427
SX-F	08-14	DMX03426
XC	08-14	DMX03427

SUZUKI	Año	Referencia
RM 125	99-09	DMX03418
RMX 125	99-09	DMX03418
RM 250	99-09	DMX03418
RMX 250	99-09	DMX03418
RMZ 250	04-07	DMX03419
RMZ 250	06-07	DMX03418
DRZ 400	00-13	DMX03418
RMZ 450	05-14	DMX03418

YAMAHA	Año	Referencia
YZ 125	97-14	DMX03418
YZ 250	99-14	DMX03418
YZ 250 F	98-06	DMX03418
YZ 250 F	07-14	DMX03417
WR 250 F	07-14	DMX03417
YZ 400 F	98-99	DMX03418
YZ 426 F	00-02	DMX03418
YZ 450 F	03-06	DMX03418
YZ 450 F	07-14	DMX03417
WR 450 F	07-14	DMX03417



CONTROLES MANDOS



EMIGO Paramanos

Para proteger las manos de las piedras o del frío.
Fáciles de montar. Se venden solos o en cajas de 5 juegos.

Referencia	Descripción	€
E79-97937	Paramanos Azul Yamaha	23,96
E79-97931	Paramanos Rojo Honda	23,96
E79-97934	Paramanos Negro	23,96
E79-97936	Paramanos Transparente	23,96
E79-97930	Paramanos Blanco	23,96
E79-97935	Paramanos Carbono	26,81
E79-97939	* Recambio anclajes	9,90

* Los pilotos que sustituyan el manillar y no deseen perder los protectores de manos, disponen de los anclajes interiores del manillar como recambio.



PSYCHIC Paramanos

Referencia	Descripción	€
DMX12027BU	Paramanos Azul Yamaha	28,21
DMX12027RD	Paramanos Rojo Honda	28,21
DMX12027BK	Paramanos Negro	28,21
DMX12027YL	Paramanos Amarillo	28,21
DMX12027WI	Paramanos Blanco	28,21
DMX12027GN	Paramanos Verde	28,21



PSYCHIC Manillares aluminio Ø28

Manillar aluminio 7075T6
anodizado tipo tapered



Referencia	Descripción	€
DMX08148BK	Manillar aluminio negro Ø 28mm (protector incluido), largo 790mm	58,35
DMX08148BU	Manillar aluminio azul Ø 28mm (protector incluido), largo 790mm	58,35
DMX08148GL	Manillar aluminio dorado Ø 28mm (protector incluido), largo 790mm	58,35
DMX08148OR	Manillar aluminio naranja Ø 28mm (protector incluido), largo 790mm	58,35
DMX08148RD	Manillar aluminio rojo Ø 28mm (protector incluido), largo 790mm	58,35
DMX08148TI	Manillar aluminio titanio Ø 28mm (protector incluido), largo 790mm	58,35

Calefacción manos

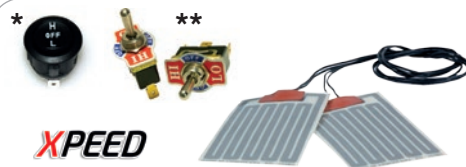

Ofrece una temperatura de confort a las manos.
Dispone de dos intensidades. Fácil montaje.
Se puede servir con dos modelos de interruptor.

Referencia		€
D12170A	Calefactable *	30,73
D12170B	Calefactable **	30,73
D1216604	Interruptor recambio **	6,90

BRONCO

EMIGO

Elevadores manillar de aluminio

Eleva el manillar económicamente y sin trabajo, si eres alto podrás conducir más cómodamente y sin doblar tan pronunciadamente la espalda.
Fabricados con aluminio AL 6061



Referencia	Descripción	Color	€
DMX081101	de Ø 22 mm a 22 mm, 2 cm más alto	aluminio	31,14
DMX081681	de Ø 22 mm a 22 mm, 2 cm más alto	negro	33,38
DMX08171	de Ø 22 mm a 22 mm, 2 a 4 cm más alto	aluminio	41,95
DMX08110	de Ø 22 mm a 28,6 mm, 2 cm más alto	aluminio	31,14
DMX08110BK	de Ø 22 mm a 28,6 mm, 2 cm más alto	negro	31,14
DMX08110BU	de Ø 22 mm a 28,6 mm, 2 cm más alto	azul	31,14
DMX08110OR	de Ø 22 mm a 28,6 mm, 2 cm más alto	naranja	31,14
DMX08168	de Ø 22 mm a 28,6 mm, 2 cm más alto	negro	33,38
E23-08191	de Ø 22 mm a 28,6 mm, 2 cm más alto	aluminio	45,12
DMX081711	de Ø 28,6 mm a 28,6 mm, 2 a 4 cm más alto	aluminio	44,76
DMX08151	Elevador manillar moto Ø 28,6 mm	aluminio	36,12

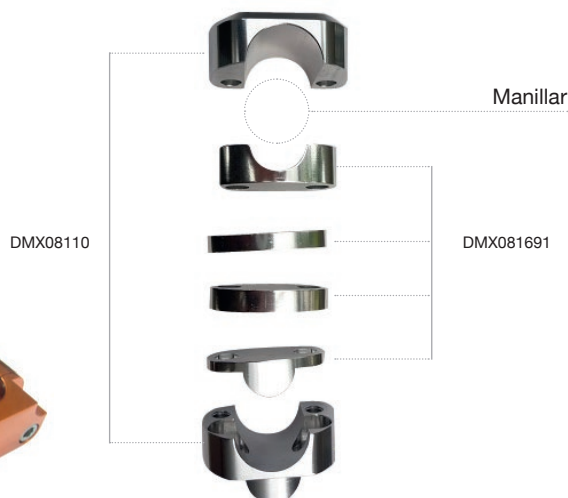

XPEED Puños



Referencia	Descripción	€
DMX08003	Puños de goma Negros 22 - 24	5,44
DMX08020	Puños de goma Negros 22 - 24	7,36
DMX08027	Puños de goma Grises 22 - 24	7,36
R520111	Puños de goma Grises 22 - 24	7,36
R520113	Puños de goma Negros 22 - 24	7,36
R520121	Puños de goma Grises 22 - 24	7,36
R520153	Puños de goma Negros 22 - 24	7,36
R520171	Puños de goma Azules 22 - 24	7,36

XPEED Varilla manillar



Referencia	Descripción	€
RY100A	Varilla manillar Ø 22 Xpeed	13,80



XPEED Donuts



Referencia	Descripción	€
R620010K	Protector de pulgar Negro	3,20



Mando acelerador



DMX08660
Honda 4t



DMX08661
Kawasaki 4t
Suzuki 4t
Yamaha 4t



DMX08662
Magura 313



DMX08664
KTM 4t



D101054
Vortex



D101057
Turbo



D101059
Motion Pro

Modelos específicos

HONDA	Año	Referencia	€
CR 125 R	93-03	D101054	21,33
CR 250 R	93-03	D101054	21,33
CRF 230 F	03-07	DMX08660	17,14
CRF 250 R	04-08	DMX08660	17,14
CRF 250 X	04-12	DMX08660	17,14
CRF 450 R	02-08	DMX08660	17,14
CRF 450 X	05-14	DMX08660	17,14

KAWASAKI	Año	Referencia	€
KX 125	92-05	D101054	21,33
KX 250	92-05	D101054	21,33
KX 250 F	04-16	DMX08661	15,64
KX 450 F	06-16	DMX08661	15,64

KTM	Año	Referencia	€
SXF 250	05-12	DMX08664	24,75
XCF 250	05-12	DMX08664	24,75
SXF 450	05-12	DMX08664	24,75
XCF 450	05-12	DMX08664	24,75
SXF 530	05-12	DMX08664	24,75
XCF 530	05-12	DMX08664	24,75

SUZUKI	Año	Referencia	€
RM 125	95-05	D101054	21,33
RM 250	95-05	D101054	21,33
RM 250 F		DMX08661	15,64

YAMAHA	Año	Referencia	€
YZ 125	96-10	D101054	21,33
YZ 250	96-10	D101054	21,33
YZ 250 F	01-11	DMX08661	15,64
WR 250 F	01-11	DMX08661	15,64
WR 400 F	98-00	DMX08661	15,64
YZ 400 F	98-00	DMX08661	15,64
WR 426 F	01-02	DMX08661	15,64
YZ 426 F	00-02	DMX08661	15,64
WR 450 F	03-13	DMX08661	15,64
YZ 450 F	03-13	DMX08661	15,64



D101053
CR Pro

Modelos estándar

Universales	Giro	Referencia	€
TIPO CR PRO	170° 1/2	D101053	15,64
TIPO VORTEX	95° 1/4	D101054	24,05
TIPO TURBO	150° 3/4	D101057	16,59
TIPO MOTION PRO	165° 1/2	D101059	15,64
TIPO MAGURA 313		DMX08662	18,33



Acelerador de aluminio

€
25



Para los pilotos que no quieran romper más la empuñadura de plástico del gas.

Para montar en manillares de 22 mm

Fabricado en aluminio AL 6061

Color aluminio con empuñadura de goma negra

HONDA	Año	Referencia
CR 125	93-08	DMX08658
CR 250	93-08	DMX08658
CRF 250	02-08	DMX08656
CRF 250 X	02-08	DMX08656
CRF 450	02-08	DMX08656
CR 500	93-08	DMX08656

KAWASAKI	Año	Referencia
KX 60	98-08	DMX08657
KX 65	00-08	DMX08657
KX 80	98-08	DMX08657
KX 85	98-08	DMX08657
KX 100	98-08	DMX08657
KX 125	93-08	DMX08657
KX 250	93-08	DMX08657
KXF 250	04-08	DMX08654
KXF 450	06-08	DMX08654

KTM	Año	Referencia
85 SX todas 2 t	97-08	DMX08658
400 todas 4 t	00-08	DMX08655
450 todas 4 t	00-08	DMX08655
520 todas 4 t	00-08	DMX08655
525 todas 4 t	00-08	DMX08655

SUZUKI	Año	Referencia
RM 65	03-08	DMX08657
RM 80	90-08	DMX08657
RM 85	02-08	DMX08657
RM 100	03-08	DMX08658
RM 125	96-08	DMX08657
RM 250	96-08	DMX08657
RMZ 250	04-08	DMX08654
RMX 450	05-08	DMX08654

YAMAHA	Año	Referencia
YZ 125	96-08	DMX08657
YZ 250	96-08	DMX08657
YZF 250	01-08	DMX08654
WRF 250	01-08	DMX08654
YZF 400	01-08	DMX08654
WRF 400	01-08	DMX08654
YZF 426	01-08	DMX08654
WRF 426	01-08	DMX08654
YZF 450	01-08	DMX08654
WRF 450	01-08	DMX08654



Cañas acelerador

€
6,82



BETA	Año	Referencia
RR 350	11-12	D101098
RR 400	08-12	D101098
RR 450	08-12	D101098
RR 498	2012	D101098
RR 520	10-11	D101098
RR 525	08-09	D101098

GAS GAS	Año	Referencia
EC 125	00-11	D101079
MC 125	00-08	D101079
EC 200	00-11	D101079
EC 250	00-12	D101079
MC 250	00-08	D101079
EC 300	00-12	D101079

HONDA	Año	Referencia
CR 80 R	85-00	D101085
CRF 80 F	04-13	D101087
CR 85 R	03-07	D101085
CRF 100 F	04-13	D101087
CR 125 R	89-07	D101079
CR 250 R	89-07	D101079
CRF 250 R	04-16	D101097
CRF 250 X	04-16	D101097
CRF 450 R	02-16	D101097
CRF 450 X	05-16	D101097
CR 500 R	90-00	D101079

HUSQVARNA	Año	Referencia
CR 125	00-12	D101079
TC 125	15-16	D101079
WR 125	00-12	D101079
CR 250 R	00-04	D101079
FC 250	14-15	D101098
FE 250	14-15	D101098
TE 250	14-15	D101079
WR 250	00-12	D101079
TE 300	14-15	D101079
WR 300	09-12	D101079
FC 350	14-15	D101098
FE 350	14-15	D101098
WR 360	00-02	D101079
TXC 449	2011	D101098
FC 450	14-15	D101098
FE 450	14-15	D101098
FE 501	14-15	D101098

HUSABERG	Año	Referencia
TE 250	11-13	D101079
TE 300	11-13	D101079
FC 450	04-05	D101098
FE 450	04-11	D101098
FC 550	04-05	D101098
FE 550	04-08	D101098
FE 570	2010	D101098

KAWASAKI	Año	Referencia
KX 60	84-03	D101092
KX 65	00-15	D101092
KX 80	89-00	D101092
KX 85	01-15	D101092
KX 100	95-15	D101092
KLX 110	02-15	D101092
KX125	92-05	DMX086531
KX250	92-07	DMX086531
KX 250 F	04-16	DMX08659
KLX 450 R	08-12	DMX08659
KX 450 F	06-16	DMX08659

KTM	Año	Referencia
85 SX 17/14	04-12	D101079
85 SX 19/16	05-10	D101079
105 SX	04-11	D101079
105 XC	08-09	D101079
125 EGS	98-99	D101079
125 EXC	98-07	D101079
125 EXE	00-01	D101079
125 SX	98-13	D101079
125 SXS	00-08	D101079
144 SX	07-08	D101079
150 SX	08-13	D101079
150 XC	10-13	D101079
200 EGS	98-99	D101079
200 EXC	98-05	D101079
200 MXC	98-03	D101079
200 SX	98-04	D101079
200 XC	06-09	D101079
200 XCW	03-13	D101079
250 EGS	98-99	D101079
250 EXC	97-05	D101079
250 MXC	98-03	D101079
250 SX	97-13	D101079
250 SX-F	05-11	D101098
250 XC	06-13	D101079
250 XC-F	07-09	D101098
250 XC-W	06-13	D101079
250 XCF-W	07-11	D101098

300 EGS	98-99	D101079
300 EXC	97-05	D101079
300 MXC	97-05	D101079
300 XC	06-13	D101079
300 XC-W	06-13	D101079
360 EXC	1997	D101079
360 MXC	1997	D101079
360 SX	1997	D101079
380 EGS	98-99	D101079
380 EXC	98-02	D101079
380 MXC	98-02	D101079
380 SX	98-02	D101079
400 EXC	01-05	D101098
400 MXC	01-02	D101098
400 SX	00-02	D101098
400 XC-W	2007	D101098
450 EXC	03-05	D101098
450 MXC	03-05	D101098
450 SMR	2005	D101098
450 SX-F	03-05	D101098
450 XC-F	07-09	D101098
450 XC-W	07-10	D101098
520 EXC	00-02	D101098
520 MXC	00-02	D101098
520 SX	00-02	D101098
525 EXC-G	06-07	D101098
525 MXC	03-05	D101098
525 SMR	04-05	D101098
525 SX	03-06	D101098
525 XC-G	06-07	D101098
525 XC-W	2007	D101098

SUZUKI	Año	Referencia
RM 125	95-07	DMX086531
RM 250	95-08	DMX086531
RMZ 250	04-13	DMX08659
RMZ 450	04-16	DMX08659
RMX 450	10-11	DMX08659

YAMAHA	Año	Referencia
YZ 125	96-16	DMX086531
YZ 250	96-16	DMX086531
WR 250 F	01-09	DMX08659
WR 250 F	11-13	DMX08659
YZ 250 F	01-11	DMX08659
WR 400 F	98-00	DMX08659
YZ 400 F	98-99	DMX08659
WR 426 F	01-02	DMX08659
YZ 426 F	00-02	DMX08659
WR 450 F	04-09	DMX08659
WR 450 F	11-15	DMX08659
YZ 450 F	03-13	DMX08659



Desmultiplicador embrague

Referencia	€
DAT05700	20,93



Kit reparación de cables

Referencia	€
DMP05092	5,28



CONTROLES Y MANDOS



Cables acelerador y embrague

Los cables cuya referencia es AZUL son 7cm más largos

HONDA	Año	Acelerador	€	Embrague	€
CR 125	00-03	D102384	11,97	D102383	9,94
CR 125	04-07	D102472	9,63	D102473	10,64
CR 250 R	04-07	D102384	11,97		
CRF 250 R	04-07	D102414	11,06	D102544	17,52
CRF 250 R	08-09	D102414	11,06	D102549	13,48
CRF 250 R	10-13	D102584	14,95	D102579	24,26
CRF 250 R	14-15	D102601	19,72	DMX05957	18,32
CRF 250 R	16-17	D102600	16,63		
CRF 250 X	04-13	D102414	11,06	D102412	9,8
CRF 450 R	02-07	D102414	11,06	D102545	16,17
CRF 450 R	2008	D102414	11,06	D102550	16,17
CRF 450 R	09-12	D102577	24,50	D102579	24,26
CRF 450 R	13-14	D102590	23,52	D102579	24,26
CRF 450 R	15-16			D102604	16,05
CRF 450 X	05-07	D102414	11,06	D102506	15,37
CRF 450 X	08-14	D102414	11,06	D102515	17,27

HUSABERG	Año	Acelerador	€	Embrague	€
TE 125	11-14	D110152	12,60	DMX05973	
FE 250	2013	D110111	18,01		
TE 250	2011	D110056	12,74		
TE 250	11-14	D110152	12,60		
TE 300	2011	D110056	12,74		
TE 300	11-14	D110152	12,60		
FE 350	2013	D110111	18,01		
FE 500	2013	D110111	18,01		

HUSQVARNA	Año	Acelerador	€	Embrague	€
TC 85	14-16	D110152	12,60	DMX05974	
TE 85	14-16	D110152	12,60	DMX05974	
CR 125	00-07	D110062	13,44	D110065	21,93
CR 125	2008	D110134	9,66		
CR 125	09-13	D110062	13,44		
CR 125	14-16	DMX05970		DMX05971	
TC 125	14-16	D110152	12,6		
TE 125	14-16	D110152	12,6		
WR 125	00-07	D110062	13,44	D110065	21,93
WR 125	2008	D110134	9,66		
WR 125	09-12	D110062	13,44		
WRE 125	04-05			D110065	21,93
CR 250	00-04	D110062	13,44		
FC 250	14-15	D110111	18,01		
FE 250	14-15	D110111	18,01		
TC 250	14-16	D110152	12,60		
TE 250	13-16	D110152	12,60		
WR 250	04-07	D110062	13,44		
WR 250	08-13			D110150	28,66
TC 300	13-15	D110056	12,74		
TE 300	13-15	D110152	12,60		
WR 300	09-12	D110134	9,66	D110150	28,66
WR 300	13-14			D110150	28,66
FC 350	14-15	D110111	18,01		
FE 350	14-15	D110111	18,01		
WR 360	00-02	D110062	13,44		
TC 449	11-12	D110148	28,66		
TXC 449	2011	D110148	28,66		
FC 450	14-15	D110111	18,01		
FE 450	14-15	D110111	18,01		

KTM	Año	Acelerador	€
85 SX	2015	DMX05963	15,72
85 XC	2008	D110056	12,74
105 SX	06-11	D110056	12,74
105 XC	08-09	D110056	12,74
125 EXC	03-05	D110056	12,74
125 EXC	15-16	DMX05963	15,72
125 SX	2013	D110152	12,60
125 SX	15-16	DMX05963	15,72
250 EXC	2015	DMX05963	15,72
250 EXC-F	07-16	D110110	19,97
250 EXC-F	06-11	D110110	19,97
250 EXCG	02-05	D110117	25,60
250 Freeride	2015	DMX05963	15,72
250 SX	97-98	D110056	12,74
250 SX	99-12	D110056	12,74
250 SX	2013	D110152	12,60
250 SX	2015	DMX05963	15,72
250 SXF	05-12	D110111	23,56
250 SXF	05-12	D110122	17,40
250 SXF	05-12	D110110	19,97
250 SXS-F	06-08	D110110	19,97
250 XCF	07-12	D110122	17,40
250 XCF	13-14	D110151	20,46
250 XC-F	07-09	D110111	23,56
250 XCF-W	07-11	D110111	23,56
250 XCFW	07-09	D110122	17,40
250 XCFW	2012	D110122	17,40
250 XCFW	2013	D110151	20,46
250 XCW	06-11	D110056	12,74
250 XCW	2013	D110152	12,60
300 MXC	97-05	D110056	12,74
300 SX	98-16	D110152	12,60
300 XC	06-12	D110056	12,74
300 XCW	06-12	D110056	12,74
300 XCW	2013	D110152	12,60
350 SX-F	11-13	D110111	23,56
350 XCF-W	11-13	D110111	23,56
350 EXCF	2013	D110151	20,46
350 SXF	11-12	D110122	17,40
350 SXF	2013	D110151	20,46
350 XCF	2011	D110122	17,40
350 XCF	2013	D110151	20,46
350 XCFW	2013	D110151	20,46
450 EXC	09-12	D110111	23,56
450 EXCG	03-06	D110117	25,60
450 EXCR	2007	D110117	25,60
450 EXCR	08-10	D110122	17,40
450 EXC-R	08-11	D110111	23,56
450 SX-F	07-12	D110111	23,56
450 SXS-F	07-08	D110111	23,56
450 XC-F	08-09	D110111	23,56
450 XCR-W	2008	D110111	23,56
450 XC-W	09-13	D110111	23,56
450 MXCG	03-05	D110117	25,60
450 XCF	06-07	D110117	25,60
450 XCF	2013	D110151	20,46
450 XCFWCE	2010	D110122	17,40
450 XCRW	2008	D110122	17,40
450 XCW	09-12	D110122	17,40
450 XCW	2013	D110151	20,46
450 XCWSD	10-11	D110122	17,40
500 EXC	2012	D110122	17,40
500 EXC	2013	D110151	20,46
505 SXF	08-09	D110122	17,40
505 SXF	08-09	D110111	23,56



Los cables cuya referencia es **AZUL** son 7cm más largos

505 XC-F	08-09	D110111	23,56
525 EXC	03-07	D110117	25,60
525 EXCG	04-06	D110117	25,60
525 MXCG	03-05	D110117	25,60
525 SX	03-06	D110117	25,60
525 XC	2007	D110117	25,60
525 XCG	2006	D110117	25,60
525 XCW	2007	D110117	25,60
530 EXC	09-11	D110122	17,40
530 EXC	09-12	D110111	23,56
530 EXCR	2008	D110122	17,40
530 EXCR	08-11	D110111	23,56
530 XCRW	2008	D110122	17,40
530 XCRW	2008	D110111	23,56
530 XCW	2009	D110122	17,40
530 XCW	09-11	D110111	23,56



TXC 511	11-12	D110148	28,66		
KAWASAKI					
	Año	Acelerador	€	Embrague	€
KX 125	00-02	D103189	8,82	D103308	12,32
KX 125	2003	D103189	8,82	D103330	12,88
KX 125	04-05	D103189	8,82	D103346	11,76
KX 250	99-00	D103189	8,82	D103304	12,88
KX 250	05-07	D103357	9,24	D103356	9,24
KX 250 F	05-08	D103365	19,11	D103359	11,39
KX 250 F	09-10	D103365	19,11	D103394	15,93
KX 250 F	11-12	D103428	29,03	D103427	14,70
KX 250 F	13-17	D103429	30,14	D103427	14,70
KX 450 F	06-08	D103365	19,11	D103367	13,72
KX 450 F	09-12	D103396	18,01	D103400	13,60
KX 450 F	13-15	D103430	19,97	D103400	13,60
KX 450 F	2016	D103439	24,99		
KX 450 F	2017	D103439	24,99		
KLX 450	08-09	D103365	19,11		

SUZUKI					
	Año	Acelerador	€	Embrague	€
RM 125	01-03	D104208	10,43	D105158	9,24
RM 125	04-06	D104208	10,43	D104210	11,48
RM 125	08-09	D104208	10,43	D104244	9,24
RM 250	01-03	D104208	10,43	D105158	9,24
RM 250	04-08	D104208	10,43	D104244	9,24
RMZ 250	05-06	D103358	17,52	D103359	11,39
RMZ 250	07-09	D104278	18,01	D104264	11,06
RMZ 250	10-12	D104278	18,01	D104319	16,78
RMZ 250	13-17	D104341	33,32	D104338	13,44
RMZ 450	05-06	D103348	21,68	D104252	10,22
RMZ 450	2007	D104278	18,01	D104252	10,22
RMZ 450	08-09	D104278	18,01		
RMZ 450	10-12	D104278	18,01	D104280	17,89
RMZ 450	13-17	D104339	34,06		
RMX 450	10-11	D104278	18,01	D104320	14,95

YAMAHA					
	Año	Acelerador	€	Embrague	€
YZ 125	99-03	D105236	11,20	D105158	9,80
YZ 125	2004	D105236	11,20	D105307	14,00
YZ 125	05-06	D105236	11,20	D102196	10,85
YZ 125	07-09	D105355	14,09	D102196	10,85
YZ 125	10-14	D105355	14,09	D105401	13,86
YZ 125	15-16			D105401	13,86
WR 250 F	03-06	D105238	21,07	D105395	18,74
WR 250 F	07-13	D105396	26,76	D105295	11,76
WR 250 F	2015	D105416	34,48		
WR 250 R	08-11			D105389	13,02
WR 250 R	08-11			D105389	13,02
YZ 250	00-03	D105237	13,35	D105234	11,90
YZ 250	2004	D105237	13,35	D105309	8,54
YZ 250	2005	D105237	13,35	D105357	13,44
YZ 250	06-14	D105355	14,09	D105357	13,44
YZ 250	15-16	D105355	14,09	D105401	13,86
YZ 250 F	01-02	D105238	21,07	D105239	12,32
YZ 250 F	2003	D105286	23,64	D105291	11,20
YZ 250 F	04-05	D105286	23,61	D105311	10,22
YZ 250 F	06-08	D105396	26,76	D105331	13,16
YZ 250 F	09-13	D105396	26,76	D105392	13,60
YZ 250 F	14-17	D105416	34,48		
WR 426 F	00-02	D105238	21,07	D105239	12,32
YZ 426 F	00-02	D105238	21,07	D105239	12,32
WR 450 F	03-06	D105286	23,64	D105293	19,60
WR 450 F	07-11	D105396	26,76		
WR 450 F	12-15	D105409	35,16		
YZ 450 F	04-05	D105286	23,64	D105311	10,22
YZ 450 F	06-08	D105286	23,64	D105333	9,24
YZ 450 F	2009	D105286	23,64	D105385	13,43
YZ 450 F	10-13	D105397	43,73	D105395	18,74
YZ 450 F	14-17	DMX05961	31,24	D105414	20,34

RUEDAS Y NEUMÁTICOS

MOTOR

ADMISIÓN / ESCAPE
REFRIGERACIÓN

ELECTRICO

SUSPENSIÓN / DIRECCIÓN

FRENOS

TRANSMISIÓN

CONTROLES Y MANDOS

CHASIS

ACCESORIOS

Soportes de maneta embrague



DMX083591A



DMX083591B



DMX08369
DMX083691



DMC08163
DMC08153

HONDA	FUNDICIÓN				FORJADA	
	Año	Descripción	Referencia	€	Referencia	€
CR 80	85-97	embrague			DMX083691	13,66
CR 85	98-07	embrague	DMX08369	7,84		
CR 125 R	96-03	embrague	DMX08369	7,84	DMX083691	13,66
CR 125 R	04-07	embrague			DMX083591B	20,34
CR 250 R	97-03	embrague	DMX08369	7,84	DMX083691	13,66
CR 250 R	04-07	embrague			DMX083591B	20,34
CRF 250 R	04-09	embrague			DMX083591A	27,20
CRF 250 R	10-16	embrague			DMX083591B	20,34
CRF 450 R	04-08	embrague			DMX083591A	27,20
CRF 450 R	09-16	embrague			DMX083591B	20,34



DMC08554
DMC085541

KAWASAKI	FUNDICIÓN				FORJADA	
	Año	Descripción	Referencia	€	Referencia	€
KX 65	00-15	embrague	DMC08163	8,40	DMC08153	13,66
KX 80	98-00	embrague	DMC08163	8,40	DMC08153	13,66
KX 85	01-13	embrague	DMC08163	8,40	DMC08153	13,66
KX 100	98-14	embrague	DMC08163	8,40	DMC08153	13,66
KX 125	90-05	embrague	DMC08163	8,40	DMC08153	13,66
KX 250	90-04	embrague	DMC08163	8,40	DMC08153	13,66
KX 450 F	09-15	embrague	DMC08163	8,40	DMC08153	13,66
KX 500	92-03	embrague	DMC08163	8,40	DMC08153	13,66



DMC08149
DMC081491
DMC08149B "Negra"

SUZUKI	FUNDICIÓN				FORJADA	
	Año	Descripción	Referencia	€	Referencia	€
RM 125	85-10	embrague	DMC08554	7,60	DMC085541	13,60
RM 250	85-10	embrague	DMC08554	7,60	DMC085541	13,60



DMC08199
DMC081991
DMC08199B "Negra"

YAMAHA	FUNDICIÓN				FORJADA	
	Año	Descripción	Referencia	€	Referencia	€
YZ 80	95-00	embrague	DMC08149	7,60	DMC081491	13,66
YZ 85	01-14	embrague	DMC08149	7,60	DMC081491	13,66
TT-R 125	00-05	embrague	DMC08149	7,60	DMC081491	13,66
YZ 125	89-99	embrague	DMC08149	7,60	DMC081491	13,66
YZ 125	00-14	embrague	DMC08199	10,78	DMC081991	17,44
WR 250	91-97	embrague	DMC08149	7,60	DMC081491	13,66
WR 250 F	01-02	embrague	DMX084551	27,44	DMX08455	36,58
YZ 250	89-99	embrague	DMC08149	7,60	DMC081491	13,66
YZ 250	00-14	embrague	DMC08199	12,04	DMC081991	17,44
YZ 250 F	01-16	embrague	DMX084551	27,44	DMX08455	36,58
WR 400 F	98-99	embrague	DMC08149	7,60	DMC081491	13,66
WR 400 F	2000	embrague	DMX084551	27,44	DMX08455	36,58
YZ 400 F	98-99	embrague	DMC08149	7,60	DMC081491	13,66
WR 426 F	01-02	embrague	DMX084551	27,44	DMX08455	36,58
WR 450 F	01-07	embrague	DMX084551	27,44	DMX08455	36,58
YZ 426	00-02	embrague	DMX084551	27,44	DMX08455	36,58
YZ 450 F	01-16	embrague	DMX084551	27,44	DMX08455	36,58



DMX08455



Manetas plegables

Manetas forjadas y plegables para minimizar los riesgos de rotura.

€
39



HONDA	Año	Referencia Freno	Referencia Embrague
CR 80	92-03	DMX08421	DMX08429
CR 80	04-07	DMX08421	
CR 85	92-07	DMX08421	DMX08429
CR 85	08-10		DMX08429
CR 125	92-03	DMX08421	DMX08429
CR 125	04-07	DMX08421	DMX08429
CR 125 R	04-07		DMX08430
CRF 150	07-14	DMX08421	DMX08429
XR 200 R	82-03	DMX08421	
CR 250	1991		DMX08429
CR 250	92-03	DMX08421	DMX08429
CR 250	04-07	DMX08421	DMX08429
CR 250 R	04-07		DMX08430
CRF 250 R	02-06	DMX08421	DMX08430
CRF 250 R	07-16	DMX08427	DMX08430
CRF 250 X	04-09	DMX08421	DMX08430
CRF 250 X	10-14	DMX08421	
XR 250 R	82-03	DMX08421	
XR 400 R	82-14	DMX08421	
CRF 450 R	02-03	DMX08421	
CRF 450 R	04-06	DMX08421	DMX08430
CRF 450 R	07-16	DMX08427	DMX08430
CRF 450 X	04-14	DMX08421	DMX08430
CR 500	91-03		DMX08429

KAWASAKI	Año	Referencia Freno	Referencia Embrague
KX 60	00-14	DMX08422	
KX 65	00-14	DMX08422	
KX 80	97-14		DMX08431
KX 85	97-99		DMX08431
KX 85	00-14	DMX08422	DMX08431
KX 100	97-99		DMX08431
KX 100	00-14	DMX08422	DMX08431
KX 125	94-99		DMX08431
KX 125	00-05	DMX08422	DMX08431
KX 125	06-09	DMX08422	
KLX 125	04-14	DMX08422	
KDX 200	00-14	DMX08422	
KX 250	94-99		DMX08431
KX 250	00-04	DMX08422	DMX08431
KX 250	05-07	DMX08422	DMX08433
KX 250	08-09	DMX08422	
KX 250 F	2004	DMX08422	DMX08431
KX 250 F	05-12	DMX08422	DMX08433
KX 250 F	13-14		DMX08433
KLX 250 DISC	04-14	DMX08422	
KX 450 F	06-12	DMX08422	DMX08433
KX 450 F	13-14		DMX08433
KLX 450	08-14	DMX08422	
KX 500	94-04		DMX08431

KTM	Año	Referencia Freno	Referencia Embrague
65 SX	2001	DMX08423	
65 SX	02-03	DMX08423	DMX08436
65 SX	04-12	DMX08424	DMX08436
65 SX	2013		DMX08436
65 XC	08-09		DMX08436
85 SX	04-12	DMX08424	DMX08436
85 SX	2013		DMX08436
105 SX	04-11	DMX08424	DMX08436
105 SX	2012	DMX08424	
105 XC	08-10		DMX08436
125 EXC	00-03		DMX08436
125 SX	98-99	DMX08423	
125 SX	00-08	DMX08423	DMX08436
125 SX	09-13	DMX08423	
125 XC-F	98-08	DMX08423	
125 XC-W	98-08	DMX08423	
144 SX	07-08		DMX08436
150 SX	98-13	DMX08423	
200 EXC	98-99	DMX08423	
200 EXC	00-05	DMX08423	DMX08436
200 EXC	06-13	DMX08423	
200 SX	00-04		DMX08436
200 XC-F	98-08	DMX08423	
200 XC-W	98-08	DMX08423	DMX08436
250 EXC	98-99	DMX08423	
250 EXC	00-05	DMX08423	DMX08436
250 SX	98-99	DMX08423	
250 SX	00-05	DMX08423	DMX08436
250 SX	06-13	DMX08423	DMX08442
250 SX	2014		DMX08442
250 SX-F	04-06	DMX08423	
250 SX-F	07-14	DMX08423	DMX08442
250 XC	98-05	DMX08423	
250 XC	06-14		DMX08442
250 XC-F	98-05	DMX08423	
250 XC-F	07-09		DMX08442
250 XC-F	11-14		DMX08442
250 XC-W	98-05	DMX08423	
250 XC-W	06-07		DMX08442
250 XC-W	08-14		DMX08442
250 XCF	04-14	DMX08423	
250 XCF-W	04-06	DMX08423	
250 XCF-W	07-14	DMX08423	DMX08442
300 EXC	98-99	DMX08423	
300 EXC	00-05	DMX08423	DMX08436
300 MXC	98-05	DMX08423	
300 SX	98-05	DMX08423	
300 XC	98-05	DMX08423	
300 XC	06-13	DMX08423	DMX08442
300 XC	2014		DMX08442
300 XC-F	98-05	DMX08423	

RUEDAS Y NEUMÁTICOS

MOTOR

ADMISIÓN / ESCAPE
REFRIGERACIÓN

ELÉCTRICO

SUSPENSIÓN / DIRECCIÓN

FRENOS

TRANSMISIÓN

CONTROLES Y MANDOS

CHASIS

ACCESORIOS



Manetas plegables

Manetas forjadas y plegables para minimizar los riesgos de rotura.

€
39



300 XC-W	98-05	DMX08423	
300 XC-W	06-14		DMX08442
300 WC-W	06-13	DMX08423	
350 EXC-F	12-14		DMX08442
350 SX	10-13	DMX08423	
350 SX-F	11-14		DMX08442
350 XC-F	11-14		DMX08442
350 XCF-W	12-14		DMX08442
380 EXC/SX	00-02		DMX08436
400 EXC 4T	00-07		DMX08436
400 SX 4T	00-02		DMX08436
400 SX-F	98-08	DMX08423	
400 XC	98-08	DMX08423	
400 XC-F	98-14	DMX08423	
400 XC-W	98-06	DMX08423	
400 XC-W	2007	DMX08423	DMX08436
400 XC-W	09-10	DMX08423	DMX08442
400 XC-W	11-14	DMX08423	
450 EXC	98-02	DMX08423	
450 EXC	03-06	DMX08423	DMX08436
450 EXC	2007	DMX08423	DMX08442
450 EXC	08-14	DMX08423	
450 EXC-R	08-11		DMX08442
450 SX 4T	03-06		DMX08436
450 SX-F	98-06	DMX08423	
450 SX-F	07-08	DMX08423	DMX08436
450 SX-F	09-12	DMX08423	
450 SX-F	2013	DMX08423	DMX08442
450 SX-F	2014		DMX08442
450 XC	98-08	DMX08423	
450 XC-F	98-05	DMX08423	
450 XC-F	06-09	DMX08423	DMX08436
450 XC-F	10-12	DMX08423	
450 XC-F	13-14	DMX08423	DMX08442
450 XC-W	98-07	DMX08423	
450 XC-W	08-14	DMX08423	DMX08442
500 EXC	12-14		DMX08442
500 XC-W	12-14		DMX08442
505 SX-F	98-06	DMX08423	
505 SX-F	07-08	DMX08423	DMX08436
505 XC	98-08	DMX08423	
505 XC-F	98-07	DMX08423	
505 XC-F	08-09	DMX08423	DMX08442
505 XC-F	10-13	DMX08423	
505 XC-W	98-14	DMX08423	
520 EXC	00-02		DMX08436
520 SX	00-02		DMX08436
525 EXC	98-14	DMX08423	
525 EXC	03-14	DMX08423	
525 EXC 4T	03-06		DMX08436
525 EXC 4T	05-06		DMX08442
525 SX	98-08	DMX08423	
525 SX 4T	03-06		DMX08436
525 XC-F	98-05	DMX08423	
525 XC-F	06-07	DMX08423	DMX08436
525 XC-F	08-14	DMX08423	
525 XC-W	98-14	DMX08423	
530 EXC	98-14	DMX08423	

SUZUKI	Año	Referencia Freno	Referencia Embrague
RM 65	03-14	DMX08422	
RM 85	96-01	DMX08421	
RM 85	02-04	DMX08425	DMX08432
RM 85	05-16	DMX08422	DMX08432
RM 100	03-04		DMX08431
DRZ 125 L	04-14	DMX08422	
RM 125	86-95	DMX08425	
RM 125	96-99	DMX08421	
RM 125	00-03	DMX08421	DMX08432
RM 125	96-07	DMX08422	DMX08432
RM 125	08-09	DMX08422	
DRZ 250	04-14	DMX08422	
RM 250	86-95	DMX08425	
RM 250	96-03	DMX08421	
RM 250	96-99	DMX08422	
RM 250	00-08	DMX08422	DMX08432
RM 250	09-14	DMX08422	
RMZ 250	05-06		DMX08433
RMZ 250	07-13		DMX08431
RMZ 450	03-05	DMX08422	
RMZ 450	06-13	DMX08422	DMX08431
RMZ 450	2014	DMX08422	

YAMAHA	Año	Referencia Freno	Referencia Embrague
YZ 80	94-00		DMX08432
YZ 80	01-14	DMX08422	DMX08432
YZ 85	94-00		DMX08432
YZ 85	01-14	DMX08422	DMX08432
TTR 125	1999	DMX08426	
TTR 125	00-14	DMX08426	DMX08432
YZ 125	94-99		DMX08432
YZ 125	00-07		DMX08433
YZ 125	08-16	DMX08428	DMX08433
TT-R 230	99-14	DMX08422	
TTR 250	N/A	DMX08426	
WR 250	00-02		DMX08433
WR 250	03-07		DMX08438
WR 250 F	02-14	DMX08422	
YZ 250	94-99		DMX08432
YZ 250	00-07		DMX08433
YZ 250	08-16	DMX08428	DMX08433
YZ 250 F	01-07	DMX08422	DMX08433
YZ 250 F	08-14	DMX08428	DMX08433
WR 400 F	02-03	DMX08422	
WR 426 F	01-02	DMX08422	
YZ 426 F	01-02	DMX08422	DMX08433
WR 426 F	00-02		DMX08433
WR 450 F	03-07		DMX08438
WR 450 F	04-07	DMX08422	DMX08438
WR 450 F	08-14	DMX08422	
YZ 450F	03-07	DMX08422	DMX08433
YZ 450 F	08-09	DMX08554	DMX08433
YZ 450 F	10-16	DMX08554	



Manetas fundición y forjadas

Manetas fundición y forjadas

Manetas de fundición a un precio inigualable. Las manetas forjadas son de calidad similar o superior a las originales, y no se rompen con facilidad, pudiendo enderezar la maneta sin llegar a la rotura.

Manetas de fundición a un precio inigualable. Las manetas forjadas son de calidad similar o superior a las originales, y no se rompen con facilidad, pudiendo enderezar la maneta sin llegar a la rotura.



HONDA	Año	FUNDICIÓN				FORJADA			
		Embrague	€	Freno	€	Embrague	€	Freno	€
CRF50F	04-16			DMP08000	4,59				
XR 50 R	00-03			DMP08000	4,59				
CRF 70 F	04-12	DAT08100	5,30	DMX08603	5,82				
XR 70 R	97-99	DAT08100	5,30	DMX08644	5,82				
XR 70 R	00-03	DAT08100	5,30	DMX08603	5,82				
CR 80 R	86-95	DMC08090B	4,90	DMC08081	5,40	DMC080901	8,20	DMC080811	5,41
CR 80 R	96-97	DMC08175	4,30			DMC081751	8,20		
CR 80 R	98-02	DMC08175	4,30	DMC08174	4,90	DMC081751	8,20	DMC081741	8,40
CRF 80 F	04-11	DAT08100	5,30	DMC08174	4,90			DMC081741	8,40
XR 80 R	96-03	DAT08100	5,30	DMX08647	4,90			DMC081741	8,40
CR 85 R	03-08	DMC08175	4,30	DMC08174	4,90	DMC081751	8,20	DMC081741	8,40
CRF 100 F	04-12	DAT08100	5,30	DMC08174	4,90			DMC081741	8,40
XR 100 R	96-03	DAT08100	5,30	DMX08647					
CR 125 R	96-03	DMC08175	4,30	DMC08174	4,90	DMC081751	8,20	DMC081741	8,40
CR 125 R	04-07	DMX08359	4,70	DMC08174	4,90	DMX083591	8,30	DMC081741	8,40
CRF 150 F	03-15	DMX08361	5,80	DMC08174	4,90			DMC081741	8,40
CRF 150 R	08-14	DMC08175	4,30	DMC08174	4,90	DMC081751	8,20	DMC081741	8,40
XR 200 R	96-01			DMC08174	4,90			DMC081741	8,40
CRF 230 F	03-15	DMX08361	5,80					DMC081741	8,40
CR 250 R	96-03	DMC08175	4,30	DMC08174	4,90	DMC081751	8,20	DMC081741	8,40
CR 250 R	04-07	DMX08359	4,70	DMC08174	4,90	DMX083591	8,30	DMC081741	8,40
CRF 250 R	04-06	DMX08359	4,70	DMC08174	4,90	DMX083591	8,30	DMC081741	8,40
CRF 250 R	07-16	DMX08394	4,90	DMX083921	10,40	DMX083941	8,80	DMX08392	16,00
CRF250 X	04-12	DMX08359	4,70	DMC08174	4,90	DMX083591	8,30	DMC081741	8,40
XR 250 R	96-04	DMC08175	4,30	DMC08174	4,90	DMC081751	8,20	DMC081741	8,40
XR 400 R	96-04	DMC08175	4,30	DMC08174	4,90	DMC081751	8,20	DMC081741	8,40
CRF 450 R	02-03	DMC08175	4,30	DMC08174	4,90	DMC081751	8,20	DMC081741	8,40
CRF 450 R	04-06	DMX08359	4,70	DMC08174	4,90	DMX083591	8,30	DMC081741	8,40
CRF 450 R	07-16	DMX08394	4,90	DMX083921	10,40	DMX083941	8,80	DMX08392	16,00
CRF 450 X	05-14	DMX08359	4,70	DMC08174	4,90	DMX083591	8,30	DMC081741	8,40
CR 500 R	96-01	DMC08175	4,30	DMC08174	4,90	DMC081751	8,20	DMC081741	8,40
XR 650 R	00-07	DMC08175	4,30	DMC08174	4,90	DMC081751	8,20	DMC081741	8,40

HUSABERG	Año	FUNDICIÓN				FORJADA			
		Embrague	€	Freno	€	Embrague	€	Freno	€
todas	89-97	DMX08407	6,31						
todas	98-08	DMX08408	8,39						
TE 250	11-13			DMX08406	7,98			DMX08398	11,70
FE 250	2014			DMX08382	12,80			DMX083821	19,54
TE 250	2014			DMX08382	12,80			DMX083821	19,54
TE 300	11-13			DMX08406	7,98			DMX08398	11,70
TE 300	2014			DMX08382	12,80			DMX083821	19,54
FE 350	2014			DMX08382	12,80			DMX083821	19,54
FE 390	10-11			DMX08406	7,98	DMX08457	21,30	DMX08398	11,70
FE 450	04-06	DMX08318 larga DMX08444 corta	8,20			DMX083181 larga	13,50		
FE 450	07-08	DMX08318 larga DMX08444 corta	8,20	DMX084051	10,30	DMX083181 larga	13,50	DMX08405	14,60
FE 450	09-13			DMX08406	7,98	DMX08457	21,30	DMX08398	11,70
FE 450	2014			DMX08382	12,80			DMX083821	19,54
FX 450	2010			DMX08406	7,98	DMX08457	21,30	DMX08398	11,70
FE 501	2004	DMX08318 larga DMX08444 corta	8,20	DMX084051	10,30	DMX083181 larga	13,50	DMX08405	14,60
FE 501	2014			DMX08382	12,80			DMX083821	19,54
FE 550	04-05	DMX08318 larga DMX08444 corta	8,20	DMX084051	10,30	DMX083181 larga	13,50	DMX08405	14,60
FC 550	04-06	DMX08318 larga DMX08444 corta	8,20			DMX083181 larga	13,50		
FC550	2007	DMX08318 larga DMX08444 corta	8,20	DMX084051	10,30	DMX083181 larga	13,50	DMX08405	14,60
FE 550	2008	DMX08318 larga DMX08444 corta	8,20	DMX084051	10,30	DMX083181 larga	13,50	DMX08405	14,60
FE 570	09-10			DMX08406	7,98	DMX08457	21,30	DMX08398	11,70
FS 570	2011			DMX08406	7,98			DMX08398	11,70
FE 570	2011			DMX08406	7,98			DMX08398	11,70



Manetas fundición y forjadas Manetas fundición y forjadas



Manetas de fundición a un precio inigualable. Las manetas forjadas son de calidad similar o superior a las originales, y no se rompen con facilidad, pudiendo enderezar la maneta sin llegar a la rotura.

Manetas de fundición a un precio inigualable. Las manetas forjadas son de calidad similar o superior a las originales, y no se rompen con facilidad, pudiendo enderezar la maneta sin llegar a la rotura.

FE 570 S	2011			DMX08406	7,98	DMX08457	21,30	DMX08398	11,70
FE 650	04-06	DMX08318 larga DMX08444 corta	8,20			DMX083181 larga	13,50		
FE 650	07-08	DMX08318 larga DMX08444 corta	8,20	DMX084051	10,30	DMX083181 larga	13,50	DMX08405	14,60
FS 650	04-08	DMX08318 larga DMX08444 corta	8,20			DMX083181 larga	13,50		

HUSQVARNA	Año	Embrague	FUNDICIÓN				FORJADA			
			€	Freno	€		Embrague	€	Freno	€
ALLMODELS	95-00	DMX08407	6,31							
WRE 125	98-07	DMX08407	6,31							
CR 125	98-99	DMX08407	6,31							
CR 125	99-09	DMC08001	5,50	DMX08406	7,98			DMX08398	11,70	
SM 125	98-99	DMX08407	6,31							
SMS 125	00-07	DMX08407	6,31							
WR 125	98-09	DMX08407	6,31							
WR 125	06-10			DMX08406	7,98			DMX08398	11,70	
CR 250	98-04	DMX08407	6,31							
SMR 250	2006	DMX08408	8,39							
SMR 250	2007	DMX08407	6,31							
TC 250	03-10	DMX08408	8,39							
TC 250	2004	DMX08407	6,31							
TC 250	05-06	DMX08407	6,31	DMX08406	7,98			DMX08398	11,70	
TC 250	07-08	DMX08407	6,31							
TC 250	10-11	DMX08397	16,97			DMX083971	11,70			
TE 250	2004	DMX08407	6,31							
TE 250	05-09	DMX08407	6,31	DMX08406	7,98			DMX08398	11,70	
TE 250	10-11	DMX08397	16,97	DMX08406	7,98	DMX083971	11,70	DMX08398	11,70	
TXC 250	10-11	DMX08397	16,97			DMX083971	11,70			
WR 250	98-02	DMX08407	6,31							
WR 250	07-			DMX08406	7,98			DMX08398	11,70	
WR 300	09-11			DMX08406	7,98			DMX08398	11,70	
TE 310	2008	DMX08408	8,39							
TXC 310	2008	DMX08408	8,39							
SMR 310	08-09	DMX08408	8,39							
TE 310	09-10	DMX08407	6,31	DMX08406	7,98			DMX08398	11,70	
TE 310	2011	DMX08397	16,97	DMX08406	7,98			DMX08398	11,70	
WR 360	99-02	DMX08407	6,31							
TE 400	2001	DMX08407	6,31							
SMR 400	04-07	DMX08407	6,31							
SMR 449	2011	DMX08397	16,97			DMX083971	11,70			
TC 449	2011	DMX08397	16,97			DMX083971	11,70			
TE 449	2011	DMX08397	16,97	DMX08406	7,98	DMX083971	11,70	DMX08398	11,70	
TXC 449	2011	DMX08397	16,97	DMX08406	7,98	DMX083971	11,70	DMX08398	11,70	
SMR 450	03-06	DMX08408	8,39							
SMR 450	04-10	DMX08407	6,31							
SMR 450 R	2009	DMX08407	6,31							
SMRR 450	2006	DMX08408	8,39							
TC 450	2004	DMX08407	6,31							
TC 450	05-06	DMX08407	6,31	DMX08406	7,98			DMX08398	11,70	
TC 450	07-10	DMX08407	6,31							
TE 450	2004	DMX08407	6,31							
TE 450	05-10	DMX08407	6,31	DMX08406	7,98			DMX08398	11,70	
SMR 511	2011	DMX08397	16,97	DMX08406	7,98	DMX083971	11,70			
TE 511	2011			DMX08406	7,98			DMX08398	11,70	
TXC 511	2011	DMX08397	16,97	DMX08406	7,98	DMX083971	11,70	DMX08398	11,70	
TE 510	2004	DMX08407	6,31							
TE 510 R	2004	DMX08407	6,31							



Manetas fundición y forjadas Manetas fundición y forjadas

Manetas de fundición a un precio inigualable. Las manetas forjadas son de calidad similar o superior a las originales, y no se rompen con facilidad, pudiendo enderezar la maneta sin llegar a la rotura.

Manetas de fundición a un precio inigualable. Las manetas forjadas son de calidad similar o superior a las originales, y no se rompen con facilidad, pudiendo enderezar la maneta sin llegar a la rotura.



KAWASAKI	FUNDICIÓN				FORJADA				
	Año	Embrague	€	Freno	€	Embrague	€	Freno	€
KX 60	90-03			DMX08610	5,82				
KX 65	00-16	DMC08147	4,80	DMX08384	6,60	DMC081471	8,40	DMX083841	10,80
KX 80	88-93	DMC08144	4,30	DMC08146	5,00	DMC081441	8,40		
KX 80	94-96	DMC08144	4,30	DMC08174	4,90	DMC081441	8,40	DMC081741	8,40
KX 80	1997	DMC08144	4,30			DMC081441	8,40		
KX 80	98-00	DMC08147	4,80	DMC08178	5,00	DMC081471	8,40	DMC081781	8,50
KX 85	01-09	DMC08147	4,80	DMX08384	6,60	DMC081471	8,40	DMX083841	10,80
KX 85	10-16	DMC08147	4,80	DMX08384	6,60	DMC081471	8,40	DMX083841	10,80
KX 100	95-96	DMC08144	4,30	DMC08174	4,90	DMC081441	8,40	DMC081741	8,40
KX 100	01-16	DMC08147	4,80	DMX08384	6,60	DMC081471	8,40	DMX083841	10,80
KLX 110	02-16			DMX08610	5,82				
KLX 110 L	10-16	DMX08611	6,19						
KX 125	90-92	DMC08147	4,80	DMC08146	5,00	DMC081471	8,40	DMC081461	8,50
KX 125	93-96	DMC08147	4,80	DMC08174	4,90	DMC081471	8,40	DMC081741	8,40
KX 125	97-99	DMC08147	4,80	DMC08178	5,00	DMC081471	8,40	DMC081781	8,50
KX 125	00-05	DMC08147	4,80	DMX08384	6,60	DMC081471	8,40	DMX083841	10,80
KLX 125L (Disco)	03-06			DMC08146	5,00			DMC081461	8,50
KLX 140 L	08-16	DMX08611	6,19	DMC08018	5,40				
KDX 200	89-94	DMC08144	4,30	DMC08146	5,00	DMC081441	8,40	DMC081461	8,50
KDX 200	95-06	DMC08144	4,30	DMC08174	4,90	DMC081441	8,40	DMC081741	8,40
KDX 220 R	97-05	DMC08144	4,30	DMC08174	4,90	DMC081441	8,40	DMC081741	8,40
KDX 250	91-94	DMC08144	4,30	DMC08146	5,00	DMC081441	8,40	DMC081461	8,50
KX 250	90-92	DMC08147	4,80	DMC08146	5,00	DMC081471	8,40	DMC081461	8,50
KX 250	93-96	DMC08147	4,80	DMC08174	4,90	DMC081471	8,40	DMC081741	8,40
KX 250	97-99	DMC08147	4,80	DMC08178	5,00	DMC081471	8,40	DMC081781	8,50
KX 250	00-04	DMC08147	4,80			DMC081471	8,40	DMX083841	10,80
KX 250	05-07	DMX08420	4,90			DMX084201	4,91	DMX083841	10,80
KX 250 F	2004	DMC08147	4,80			DMC081471	8,40	DMX083841	10,80
KX 250 F	05-10	DMX08420	4,90			DMX084201	4,91	DMX083841	10,80
KX 250 F	2011	DMX08420	4,90			DMX084201	4,91	DMX083841	10,80
KX 250 F	2012	DMX08420	4,90			DMX084201	4,91	DMX083841	10,80
KX 250 F	13-16	DMX08420	4,90	DMX08373	7,00				
KLX 300 A	97-07	DMC08144	4,30	DMC08174	4,90	DMC081441	8,40	DMC081741	8,40
KX 450 F	06-08	DMX08420	4,90					DMX083841	10,80
KX 450 F	09-12	DMX08420	4,90					DMX083841	10,80
KX 450 F	13-16	DMX08420	4,90	DMX08373	7,00				
KX 500	90-93	DMC08147	4,80	DMC08146	5,00	DMC081471	8,40	DMC081461	8,50
KX 500	94-96	DMC08147	4,80	DMC08174	4,90	DMC081471	8,40	DMC081741	8,40
KX 500	97-03	DMC08147	4,80	DMC08178	5,00	DMC081471	8,40	DMC081781	8,50
KX 500	2004	DMC08147	4,80			DMC081471	8,40	DMX083841	10,80

KTM	FUNDICIÓN				FORJADA				
	Año	Embrague	€	Freno	€	Embrague	€	Freno	€
65 SX	02-03	DMX08318 larga DMX08444 corta	8,20	DMX084051	10,30	DMX083181 larga	13,50	DMX08405	14,60
65 SX	04-11	DMX08318 larga DMX08444 corta	8,20			DMX083181 larga	13,50		
65SX	12-13	DMX08318 larga DMX08444 corta	8,20	DMX08446	16,60	DMX083181 larga	13,50	DMX084461	21,38
65 SX	2014	DMX08602		DMX08602	16,17	DMX086021	24,56	DMX086021	24,56
65 XC	08-09	DMX08318 larga DMX08444 corta	8,20			DMX083181 larga	13,50		
85 SX	03-12	DMX08318 larga DMX08444 corta	8,20			DMX083181 larga	13,50		
85 SX	2013	DMX08318 larga DMX08444 corta	8,20	DMX08456	19,17	DMX083181 larga	13,50	DMX084561	24,56
85 SX	2014	DMX08602	16,17	DMX08602	16,17	DMX086021	24,56	DMX086021	24,56
85 XC	2008	DMX08318 larga DMX08444 corta	8,20	DMX084051	10,30	DMX083181 larga	13,50	DMX08405	14,60
105 SX	03-11	DMX08318 larga DMX08444 corta	8,20	DMX084051	10,30	DMX083181 larga	13,50	DMX08405	14,60
105 XC	08-09	DMX08318 larga DMX08444 corta	8,20	DMX084051	10,30	DMX083181 larga	13,50	DMX08405	14,60
125 EXC	94-97	DMC08001	5,50	DMC08000	5,00				



Manetas fundición y forjadas Manetas fundición y forjadas



Manetas de fundición a un precio inigualable. Las manetas forjadas son de calidad similar o superior a las originales, y no se rompen con facilidad, pudiendo enderezar la maneta sin llegar a la rotura.

Manetas de fundición a un precio inigualable. Las manetas forjadas son de calidad similar o superior a las originales, y no se rompen con facilidad, pudiendo enderezar la maneta sin llegar a la rotura.

KTM	Año	FUNDICIÓN				FORJADA			
		Embrague	€	Freno	€	Embrague	€	Freno	€
125 EXC	98-99	DMX08318 larga DMX08444 corta	8,20	DMC08000	5,00	DMX083181 larga	13,50		
125 EXC	00-04	DMX08318 larga DMX08444 corta	8,20	DMX084051	10,30	DMX083181 larga	13,50	DMX08405	14,60
125 EXC	2005	DMX08318 larga DMX08444 corta	8,20			DMX083181 larga	13,50	DMX08398	11,70
125 EXC	2014			DMX08382	12,80			DMX083821	19,54
125 SX	95-97	DMC08001	5,50	DMC08000	5,00				
125 SX	98-99	DMX08318 larga DMX08444 corta	8,20	DMC08000	5,00	DMX083181 larga	13,50		
125 SX	2000	DMX08318 larga DMX08444 corta	8,20			DMX083181 larga	13,50		
125 SX	01-04	DMX08318 larga DMX08444 corta	8,20	DMX084051	10,30	DMX083181 larga	13,50	DMX08405	14,60
125 SX	05-08	DMX08318 larga DMX08444 corta	8,20			DMX083181 larga	13,50	DMX08398	11,70
125 SX	2009					DMX084571	21,31	DMX08398	11,70
125 SX	11-13					DMX084571	21,31	DMX08398	11,70
125 SX	2014			DMX08382	12,80			DMX083821	19,54
144 SX	07-08	DMX08318 larga DMX08444 corta	8,20			DMX083181 larga	13,50	DMX08398	11,70
150 SX	09-14					DMX08457	21,31	DMX08398	11,70
150 XC	10-14					DMX08457	21,31	DMX08398	11,70
200 EXC	1997			DMC08000	5,00				
200 EXC	98-99	DMX08318 larga DMX08444 corta	8,20	DMC08000	5,00	DMX083181 larga	13,50		
200 EXC	00-04	DMX08318 larga DMX08444 corta	8,20	DMX084051	10,30	DMX083181 larga	13,50	DMX08405	14,60
200 EXC	2005	DMX08318 larga DMX08444 corta	8,20			DMX083181 larga	13,50	DMX08398	11,70
200 SX	03-04	DMX08318 larga DMX08444 corta	8,20	DMX084051	10,30	DMX083181 larga	13,50	DMX08405	14,60
200 XC	06-08	DMX08318 larga DMX08444 corta	8,20			DMX083181 larga	13,50	DMX08398	11,70
200 XC	2009					DMX08457	21,30	DMX08398	11,70
200 XCW	06-08	DMX08318 larga DMX08444 corta	8,20			DMX083181 larga	13,50	DMX08398	11,70
200 XCW	09-14					DMX08457	21,31	DMX08398	11,70
200 EXC	2014			DMX08382	12,80			DMX083821	19,54
250 EXC	94-97	DMC08001	5,50	DMC08000	5,00				
250 EXC	98-99			DMC08000	5,00				
250 EXC	1999	DMX08318 larga DMX08444 corta	8,20	DMC08000	5,00	DMX083181 larga	13,50		
250 EXC	00-04	DMX08318 larga DMX08444 corta	8,20	DMX084051	10,30	DMX083181 larga	13,50	DMX08405	14,60
250 EXC	2005	DMX08318 larga DMX08444 corta	8,20			DMX083181 larga	13,50	DMX08398	11,70
250 EXC	2014			DMX08382	12,80			DMX083821	19,54
250 EXCG	02-04	DMX08318 larga DMX08444 corta	8,20	DMX084051	10,30	DMX083181 larga	13,50	DMX08405	14,60
250 SX	94-97	DMC08001	5,50	DMC08000	5,00				
250 SX	1998			DMC08000	5,00				
250 SX	1999	DMX08318 larga DMX08444 corta	8,20	DMC08000	5,00	DMX083181 larga	13,50		
250 SX	00-04	DMX08318 larga DMX08444 corta	8,20						
250 SX	2005	DMX08318 larga DMX08444 corta	8,20	DMX084051	10,30	DMX083181 larga	13,50	DMX08405	14,60
250 SX	06-13	DMX083971	16,97	DMX083981	6,79	DMX08397	13,50	DMX08398	11,70
250 SX	2014					DMX083971	11,70	DMX08398	11,70
250 SXF	06-13	DMX08397	16,97	DMX08382	12,80			DMX083821	19,54
250 XC	06-13	DMX08397	16,97			DMX083971	11,70	DMX08398	11,70
250 XC	2014					DMX083971	11,70	DMX08398	11,70
250 XCF	07-09	DMX08397	16,97	DMX08382	12,80			DMX083821	19,54
250 XCF (ALL)	11-13	DMX08397	16,97			DMX083971	11,70	DMX08398	11,70
250 XCW	07-13	DMX08397	16,97			DMX083971	11,70	DMX08398	11,70
250 XCF-W	2014					DMX083971	11,70	DMX08398	11,70
FREERIDE 250 R	2014	DMX08602	16,17	DMX08382	12,80			DMX083821	19,54



Manetas fundición y forjadas Manetas fundición y forjadas



Manetas de fundición a un precio inigualable. Las manetas forjadas son de calidad similar o superior a las originales, y no se rompen con facilidad, pudiendo enderezar la maneta sin llegar a la rotura.

Manetas de fundición a un precio inigualable. Las manetas forjadas son de calidad similar o superior a las originales, y no se rompen con facilidad, pudiendo enderezar la maneta sin llegar a la rotura.

KTM	Año	FUNDICIÓN				FORJADA			
		Embrague	€	Freno	€	Embrague	€	Freno	€
300 EXC	1994	DMC08001	5,50	DMX08602	16,17	DMX086021	24,56	DMX086021	24,56
300 EXC	95-97	DMC08001	5,50	DMC08000	5,00				
300 EXC	1999	DMX08318 larga DMX08444 corta	8,20	DMC08000	5,00				
300 EXC	00-04	DMX08318 larga DMX08444 corta	8,20	DMC08000	5,00	DMX083181 larga	13,50		
300 EXC	2005	DMX08318 larga DMX08444 corta	8,20	DMX084051	10,30	DMX083181 larga	13,50	DMX08405	14,60
300 XC	06-13	DMX08397	16,97			DMX083971	11,70	DMX08398	11,70
300 XCW	06-13	DMX08397	16,97			DMX083971	11,70	DMX08398	11,70
300 XC-W	2014					DMX083971	11,70	DMX08398	11,70
350 EXCF	12-13	DMX08397	16,97	DMX08382	12,80			DMX083821	19,54
350 SXF	11-13	DMX08397	16,97			DMX08404	5,57	DMX08398	11,70
350 SX-F	2014	DMX08602	16,17			DMX083971	11,70	DMX08398	11,70
350 XCF	11-13	DMX08397	16,97	DMX08602	16,17	DMX086021	24,56	DMX086021	24,56
FREERIDE 350	12-13					DMX083971	11,70	DMX08398	11,70
FREERIDE 350	2014	DMX08602	16,17	DMX08456	19,17			DMX084561	24,56
360 EXC	96-97	DMC08001	5,50	DMX08602	16,17	DMX086021	24,56	DMX086021	24,56
360 SX	96-97	DMC08001	5,50	DMC08000	5,00				
380 EXC	00-02	DMX08318 larga DMX08444 corta	8,20	DMC08000	5,00				
380 SX 0	00-02	DMX08318 larga DMX08444 corta	8,20	DMX084051	10,30	DMX083181 larga	13,50	DMX08405	14,60
400 EXC	01-02	DMX08318 larga DMX08444 corta	8,20	DMX084051	10,30	DMX083181 larga	13,50	DMX08405	14,60
400 EXCG	2005	DMX08318 larga DMX08444 corta	8,20	DMX084051	10,30	DMX083181 larga	13,50	DMX08405	14,60
400 RXC	95-97			DMX084051	10,30	DMX083181 larga	13,50	DMX08405	14,60
400 SX	1997			DMC08000	5,00				
400 SX	01-02	DMX08318 larga DMX08444 corta	8,20	DMC08000	5,00				
400 XCW	2007	DMX08318 larga DMX08444 corta	8,20	DMX084051	10,30	DMX083181 larga	13,50	DMX08405	14,60
400 XCW	09-10	DMX08397	16,97			DMX083181 larga	13,50	DMX08398	11,70
440 EXC	1994	DMC08001	5,50			DMX083971	11,70	DMX08398	11,70
440 EXC	1995	DMC08001	5,50						
450 EXCG	03-04	DMX08318 larga DMX08444 corta	8,20	DMC08000	5,00				
450 EXCG	05-06	DMX08318 larga DMX08444 corta	8,20	DMX084051	10,30	DMX083181 larga	13,50	DMX08405	14,60
450 EXCR	07-11	DMX08397	16,97			DMX083181 larga	13,50		
450 EXC	2014	DMX08397	16,97			DMX083971	11,70	DMX08398	11,70
450 SMR	04-08	DMX08318 larga DMX08444 corta	8,20			DMX083181 larga	13,50	DMX08398	11,70
450 SMR	2009					DMX083181 larga	13,50		
450 SMR	2012					DMX084571	21,31		
450 SX ATV	09-10					DMX084571	21,31		
450 SXF	03-04	DMX08318 larga DMX08444 corta	8,20			DMX084571	21,31		
450 SXF	05-07	DMX08318 larga DMX08444 corta	8,20	DMX084051	10,30	DMX083181 larga	13,50	DMX08405	14,60
450 SXF	2008	DMX08397	16,97			DMX083181 larga	13,50	DMX08398	11,70
450 SXF	09-13					DMX083971	11,70	DMX08398	11,70
450 SXF	13					DMX084571	21,31	DMX08398	11,70
450 SXF	2014	DMX08397	16,97			DMX083971	11,70	DMX08398	11,70
450 XC ATV	2009			DMX08382	12,80	DMX083971	11,70	DMX083821	19,54
450 XCF	06-07	DMX08318 larga DMX08444 corta	8,20			DMX08457	21,30		
450 XCF	2008					DMX083181 larga	13,50	DMX08398	11,70
450 XCF	2009	DMX08318 larga DMX08444 corta	8,20					DMX08398	11,70
450 XCFWCE	2010	DMX08397	16,97			DMX083181 larga	13,50	DMX08398	11,70
450 XCRW	2008	DMX08397	16,97			DMX083971	11,70	DMX08398	11,70
450 XCW	2007	DMX08318 larga DMX08444 corta	8,20			DMX083971	11,70	DMX08398	11,70
450 XCW	2009	DMX08397	16,97			DMX083181 larga	13,50	DMX08398	11,70

RUEDAS Y NEUMÁTICOS

MOTOR

ADMISIÓN / ESCAPE
REFRIGERACIÓN

ELECTRICO

SUSPENSIÓN / DIRECCIÓN

FRENOS

TRANSMISIÓN

CONTROLES Y MANDOS

CHASIS

ACCESORIOS

CONTROLES Y MANDOS

PSYCHIC
MAX COMPONENTE

Manetas fundición y forjadas Manetas fundición y forjadas



Manetas de fundición a un precio inigualable. Las manetas forjadas son de calidad similar o superior a las originales, y no se rompen con facilidad, pudiendo enderezar la maneta sin llegar a la rotura.

Manetas de fundición a un precio inigualable. Las manetas forjadas son de calidad similar o superior a las originales, y no se rompen con facilidad, pudiendo enderezar la maneta sin llegar a la rotura.

450 XCW	2012	DMX08397	16,97			DMX083971	11,70	DMX08398	11,70
450 XCWSD	10-12	DMX08397	16,97			DMX083971	11,70	DMX08398	11,70
500 EXC	2014	DMX08397	16,97			DMX083971	11,70	DMX08398	11,70
500 XCW	2012	DMX08397	16,97	DMX08382	12,80	DMX083971	11,70	DMX083821	19,54
500 XCW	2013	DMX08397	16,97			DMX083971	11,70		
505 XCF	2009	DMX08318 larga DMX08444 corta	8,20			DMX083971	11,70	DMX08398	11,70
520 EXC/MXC/SX	01-02	DMX08318 larga DMX08444 corta	8,20			DMX083181 larga	13,50	DMX08398	11,70
525 EXC	2003	DMX08318 larga DMX08444 corta	8,20	DMX084051	10,30	DMX083181 larga	13,50	DMX08405	14,60
525 EXC	2007			DMX084051	10,30	DMX083181 larga	13,50	DMX08405	14,60
525 EXCG	2004	DMX08318 larga DMX08444 corta	8,20					DMX08398	11,70
525 EXCG	05-06	DMX08318 larga DMX08444 corta	8,20	DMX084051	10,30	DMX083181 larga	13,50	DMX08405	14,60
525 SMR	2004	DMX08318 larga DMX08444 corta	8,20			DMX083181 larga	13,50	DMX08398	11,70
525 SX	03-04	DMX08318 larga DMX08444 corta	8,20			DMX083181 larga	13,50		
525 SX	05-06	DMX08318 larga DMX08444 corta	8,20	DMX084051	10,30	DMX083181 larga	13,50	DMX08405	14,60
525 XC	2007	DMX08318 larga DMX08444 corta	8,20			DMX083181 larga	13,50	DMX08398	11,70
525 XCW	2007	DMX08318 larga DMX08444 corta	8,20			DMX083181 larga	13,50	DMX08398	11,70
530 EXC	10-11	DMX08397	16,97			DMX083181 larga	13,50	DMX08398	11,70
530 EXCCE	2010	DMX08397	16,97			DMX083971	11,70	DMX08398	11,70
530 EXCR	2008	DMX08397	16,97			DMX083971	11,70	DMX08398	11,70
530 EXCR	2009					DMX083971	11,70	DMX08398	11,70
	2008	DMX08397	16,97					DMX08398	11,70
530 XCW	2009	DMX08397	16,97			DMX083971	11,70	DMX08398	11,70
530 XCW	2010					DMX083971	11,70	DMX08398	11,70
530 XCWSD	10-11	DMX08397	16,97					DMX08398	11,70
620 RXC	95-97			DMC08000	5,00				
620 SX	1997			DMC08000	5,00				
640 LC4 Adventure	04-07			DMC08000	5,00				
660 RFR	2007								
690 Enduro	08-10			DMX084051	10,30				
690 RFR	08-09	DMX083181	13,50	DMC08000	5,00				
950 Adventure	03-06	DMX083181	13,50	DMX08405	14,60			DMX084051	10,30
950 Super EnduroR	07-08			DMC08000	5,00				
950 Super EnduroR	2009	DMX083181	13,50	DMC08000	5,00				
950 Super Moto	2006	DMX083181	13,50	DMC08000	5,00				
990 Adventure	07-08	DMX083181	13,50	DMC08000	5,00				
990 Adventure R	09-12	DMX083181	13,50						
990 SMR	10-11	DMX083181	13,50						
990 SMT	2010	DMX083181	13,50						

SUZUKI	Año	FUNDICIÓN				FORJADA			
		Embrague	€	Freno	€	Embrague	€	Freno	€
RM 65	03-05	DMC08147	4,80	DMX08384	6,60	DMC081471	8,40	DMX083841	10,80
RM 80	86-01	D5255	4,30	D5254	4,90			D52541	6,91
RM 85	02-04	DMC08176	5,20	D5254	4,90	DMC081761	8,50	D52541	6,91
RM 85	05-12	DMC08176	5,20	DMX08384	6,60	DMC081761	8,50	DMX083841	10,80
RM 125	85-91	D5255	4,30	D5254	4,90			D52541	6,91
RM 125	92-95	DMC08176	5,20	D5254	4,90	DMC081761	8,50	D52541	6,91
RM 125	97-03	DMC08176	5,20	DMC08140	5,40	DMC081761	8,50	DMC081401	6,41
RM 125	04-08	DMC08176	5,20	DMX08384	6,60	DMC081761	8,50	DMX083841	10,80
DRZ 250	01-07	DMX08371	5,60	D5254	4,90			D52541	6,91
RM 250	85-91	D5255	4,30	D5254	4,90			D52541	6,91
RM 250	92-95	DMC08176	5,20	D5254	4,90	DMC081761	8,50	D52541	6,91
RM 250	97-03	DMC08176	5,20	DMC08140	5,40	DMC081761	8,50	DMC081401	6,41
RM 250	04-08	DMC08176	5,20	DMX08384	6,60	DMC081761	8,50	DMX083841	10,80
RMZ 250	2004	DMC08147	4,80	DMX08384	6,60	DMC081471	8,40	DMX083841	10,80
RMZ 250	05-06	DMC08198	4,60	DMX08384	6,60	DMC081981	4,60	DMX083841	10,80

PSYCHIC
MAX COMPONENTE

Manetas fundición y forjadas Manetas fundición y forjadas

Manetas de fundición a un precio inigualable. Las manetas forjadas son de calidad similar o superior a las originales, y no se rompen con facilidad, pudiendo enderezar la maneta sin llegar a la rotura.

Manetas de fundición a un precio inigualable. Las manetas forjadas son de calidad similar o superior a las originales, y no se rompen con facilidad, pudiendo enderezar la maneta sin llegar a la rotura.



RMZ 250	07-16	DMC08176	5,20	DMX08384	6,60	DMC081761	8,50	DMX083841	10,80
DR 350	90-00	D5255	4,30	D5254	4,90			D52541	6,91
DR 350 S	90-93	D5255	4,30						
DR 350 SE	94-99	D5255	4,30						
DRZ 400 S	00-12	DMX08371	5,60	DMX08609	6,43				
DRZ 400 E	00-07	DMX08371	5,60	DMC08140	5,40			DMC081401	6,41
DRZ 400 SM	05-09			DMX08609	6,43				
RMZ 450	05-16	DMC08176	5,20	DMX08384	6,60	DMC081421	8,50	DMX083841	10,80
RMX 450	2010	DMC08176	5,20	DMX08384	6,60	DMC081761	8,50	DMX083841	10,80

YAMAHA	Año	FUNDICIÓN			FORJADA				
		Embrague	€	Freno	€	Embrague	€	Freno	€
YZ 80	97-00	DMC08176	5,20	DMC08180	5,00	DMC081761	8,50	DMC081801	8,50
YZ 80	2001	DMC08176	5,20	DMX08384	6,60	DMC081761	8,50	DMX083841	10,80
YZ 85	02-12	DMC08176	5,20	DMX08384	6,60	DMC081761	8,50	DMX083841	10,80
YZ 85	13-16			DMX08384	6,60			DMX083841	10,80
YZ 125	94-95	DMC08176	5,20			DMC081761	8,50		
YZ 125	96-99	DMC08176	5,20	DMC08180	5,00	DMC081761	8,50	DMC081801	8,50
YZ 125	2000			DMC08180	5,00			DMC081801	8,50
YZ 125	01-06	DMX08483	4,70	DMX08384	6,60			DMX083841	10,80
YZ 125	2007	DMX08483	4,70	DMX08384	6,60			DMX083841	10,80
YZ 125	08-14	DMX08483	4,70	DMX084001	7,10	DMX08454	7,30	DMX084001	11,80
YZ 125	2015	DMX08483	4,70	DMX084001	7,10			DMX084001	11,80
TTR 250	99-06	DMC08176	5,20	DMC08133	5,00	DMC081761	8,50	DMC081331	8,50
WR 250	92-96	DMC08176	5,20	DMC08136	5,00	DMC081761	8,50	DMC081361	8,50
WR 250	1997	DMC08176	5,20	DMC08180	5,00	DMC081761	8,50	DMC081801	8,50
WR 250 F	01-02	DMX08483	4,70	DMX08384	6,60	DMC08065	7,30	DMX083841	10,80
WR 250 F	03-05	DMX08404	5,57	DMX08384	6,60	DMX08395	8,40	DMX083841	10,80
WR 250 F	2006	DMX08612	5,57	DMX08384	6,60	DMX08395	8,40	DMX083841	10,80
WR 250 F	2007	DMX08612	5,57	DMX08384	7,10	DMX08395	8,40	DMX083841	10,80
WR 250 F	08-15	DMX08612	5,57	DMX08384	7,10	DMX08395	8,40	DMX083841	10,80
WR 250 R	08-14	DMC08134	4,30	DMC08133	5,00	DMC081341	7,20	DMC081331	8,50
WR 250 X	08-14	DMC08134	4,30	DMC08133	5,00	DMC081341	7,20	DMC081331	8,50
WR 250 Z	1991	DMC08176	5,20	DMC08136	5,00	DMC081761	8,50	DMC081361	8,50
YZ 250	94-95	DMC08176	5,20	DMC08136	5,00	DMC081761	8,50	DMC081361	8,50
YZ 250	96-99	DMC08176	5,20	DMC08180	5,00	DMC081761	8,50	DMC081801	8,50
YZ 250	2000	DMX08483	4,70	DMC08180	5,00			DMC081801	8,50
YZ 250	01-06	DMX08483	4,70	DMX08384	6,60	DMC08065	7,30	DMX083841	10,80
YZ 250	2007	DMX08483	4,70	DMX08384	6,60	DMC08065	7,30	DMX083841	10,80
YZ 250	08-14	DMX08483	4,70	DMX084001	7,10	DMC08065	7,30	DMX084001	11,80
YZ 250	2015	DMX08483	4,70	DMX084001	7,10			DMX084001	11,80
YZ 250 F	01-05	DMX08483	4,70	DMX08384	6,60			DMX083841	10,80
YZ 250 F	2006	DMX08483	4,70	DMX08384	6,60			DMX083841	10,80
YZ 250 F	2007	DMX08483	4,70	DMX084001	7,10			DMX084001	11,80
YZ 250 F	2008	DMX08483	4,70	DMX084001	7,10			DMX084001	11,80
YZ 250 F	09-15	DMX08483	4,70	DMX084001	7,10			DMX084001	11,80
WR 400 F	1998	DMC08176	5,20	DMC08180	5,00	DMC081761	8,50	DMC081801	8,50
WR 400 F	1999	DMC08176	5,20	DMC08180	5,00	DMC081761	8,50	DMC081801	8,50
WR 400 F	2000			DMC08180	5,00			DMC081801	8,50
WR 400 F	01-02	DMX08483	4,70	DMX08384	6,60			DMX083841	10,80
YZ 400 F	98-99	DMC08176	5,20	DMC08180	5,00	DMC081761	8,50	DMC081801	8,50
WR 426 F	01-02	DMX08483	4,70	DMX08384	6,60				10,80
YZ 426 F	2000			DMC08180	5,00			DMC081801	8,50
YZ 426 F	01-02	DMX08483	4,70	DMX08384	6,60			DMX083841	10,80
WR 450 F	03-04	DMX08404	5,57	DMX08384	6,60	DMX084041	8,40	DMX083841	10,80
WR 450 F	2005	DMX08404	5,57	DMX08384	6,60	DMX08395	8,40	DMX083841	10,80
WR 450 F	06-11	DMX08404	5,57	DMX08384	6,60	DMX08395	8,40	DMX083841	10,80
WR 450 F	12-15	DMX08404	5,57			DMX08395	8,40		
YZ 450 F	03-05	DMX08483	4,70	DMX08384	6,60	DMC08065	7,30	DMX083841	10,80
YZ 450 F	06-07	DMX08483	4,70	DMX08384	6,60	DMC08065	7,30	DMX083841	10,80
YZ 450 F	2008	DMX08483	4,70	DMX084001	7,10	DMC08065	7,30	DMX084001	11,80
YZ 450 F	09-15	DMX08483	4,70	DMX084001	7,10	DMX08454	8,80	DMX084001	11,80

CONTROLES Y MANDOS



Pedales de arranque



DMX08955SL

Aluminio
74,58€

GAS GAS

Año

Enducross 250



DMX08951SL DMX08951RD

Aluminio Rojo
74,58€ 79,39€

HONDA

Año

CRF 250 F 12-16



DMX08942SL

Aluminio
74,58€

HONDA

Año

CRF 150 R 07-16



DMX08950SL DMX08950RD

Aluminio Rojo
74,58€ 79,39€

HONDA

Año

CRF 450 F 12-16



DMX08944SL

Aluminio
74,58€

HUSQVARNA

Año

TC 125 14-15
TE 125 14-15



DMX08958SL

Aluminio
74,58€

HUSQVARNA

Año

TC 250 14-15
TE 250 12-15
TE 300 12-15



DMX08953SL DMX08953GN

Aluminio Verde
74,58€ 79,39€

KAWASAKI

Año

KX 250 F 13-16
KLX 450 R 08-09



DMX08945SL DMX08945GN

Aluminio Verde
74,58€ 79,39€

KAWASAKI

Año

KX 450 F 07-16



DMX08960SL DMX08960OR

Aluminio Naranja
74,58€ 79,39€

KTM

Año

SX 85 03-15
SXS 85 12-13
XC 85 08-09
SX 105 04-11
XC 105 08-09



DMX08944SL

Aluminio
74,58€

KTM

Año

EXC 125 13-15
SX 125 13-16
SX 150 13-16
XC 150 13-14
XC-W 200 13-16



DMX08958SL DMX08958OR

Aluminio Naranja
74,58€ 79,39€

KTM

Año

SX 250 11-16
SX-F 250 11-
XC 250 11-16
XC-F 250 11-
XC-W 250 11-16
XCF-W 250 12-16

XC 300 11-16
XC-F 300 11-15
XC-W 300 11-16
XC-F 350 14-16
EXCF-W 350 12-13
XC-F 350 11-12
XCF-W 350 12-16
XC-W 450 12-16
XC-XCW 500 12-16



DMX08959SL DMX08959OR

Aluminio Naranja
74,58€ 79,39€

KTM

Año

SX 150 12-15



Pedales de arranque



DMX08957SL
Aluminio
74,58€

SUZUKI Año
RMZ 250 11-14



DMX08956SL
Aluminio
74,58€

SUZUKI Año
RMZ 450 08-14
RMX 450 10-11



DMX08939SL DMX08939BU
Aluminio Azul
74,58€ 79,39€

YAMAHA Año
YZ 125 86-16



DMX08941SL DMX08941BU
Aluminio Azul
74,58€ 79,39€

YAMAHA Año
YZ 250 07-16



DMX08955SL DMX08955BU
Aluminio Azul
74,58€ 79,39€

YAMAHA Año
YZ 250 F 10-13



DMX08943SL DMX08943BU
Aluminio Azul
74,58€ 79,39€

YAMAHA Año
YZ 250 F 10-16
WR 250 F 11-16



DMX08954SL DMX08954BU
Aluminio Azul
74,58€ 79,39€

YAMAHA Año
YZ 450 F 10-13
WR 450 F 12-15



DMX08940SL DMX08940BU
Aluminio Azul
74,58€ 79,39€

YAMAHA Año
YZ 450 F 14-17
WR 450 F 2016



RUEDAS Y NEUMÁTICOS

MOTOR

ADMISIÓN / ESCAPE
REFRIGERACIÓN

ELÉCTRICO

SUSPENSIÓN / DIRECCIÓN

FRENOS

TRANSMISIÓN

CONTROLES Y MANDOS

CHASIS

ACCESORIOS



Pedales de cambio



DMX08529 28,00€

BETA	
	Año
125 RE	13-15
125 RR	13-15
125 RR LC	10-15



DMX08502 35,00€

BETA	
	Año
250 RR 2t	13-16
300 RR 2t	13-16
300 Xtrainer 2t	15-16
350 RR 4t	11-16
400 RR 4t	10-14
430 RR 4t	15-16
450 RR 4t	10-14
480 RR 4t	15-16
498 RR 4t	12-14
500 RR 4t	2015
520 RS 4t	10-14



DMX08059 28,00€

GAS GAS	
	Año
EC 50	00-05
MC 50	2005
SM 50	02-05
EC 125	99-05
MC 125	02-05
MX 125	03-05
Pampera 125	98-05
SM 125	02-05
EC 200	99-05
Pampera 200	1998

XC 200	2000
EC 250	98-05
MX 250	99-05
SM 250	02-05
XC 250	99-00
Pampera 280	02-05
EC 300	99-05
MX 300	2000
XC 300	2000
EC 400	02-03
EC 450	03-05
SM 400	02-03
SM 450	04-05



DMX061131 28,00€

HONDA	
	Año
CR 125	83-07
CR 250	88-92
CR 500	89-01



DMX061271 28,00€

HONDA	
	Año
CR 250 R	02-07



DMX061331 28,00€

HONDA	
	Año
CRF 250 R	04-09
CRF 250 X	04-16
CRF 450 R	02-07



DMX08097 28,00€

HONDA	
	Año
CRF 250 R	10-17



DMX08081 28,00€

HONDA	
	Año
CRF 450 R	08-10



DMX08098 28,00€

HONDA	
	Año
CRF 450 R	11-16
CRF 450 X	05-16



DMX08069 28,00€

HUSABERG	
	Año
FE 400 E	02-03
FS 400 E	2003
FC 450	04-05
FE 450 E	04-06
FS 450 C	04-06
FS 450 E	05-06
FC 470	2002

FC 470 E	2002
FX 470 E	2002
FE 501 E	02-03
FC 550	02-05
FE 550 E	04-06
FE 650 E	02-06
FS 650 C	05-06
FS 650 E	02-06
FX 650 E	02-03



Pedales de cambio



DMX08070 28,00€

KAWASAKI	
	Año
KX 60	86-01
KX 65	00-07
KX 80	91-00
KX 85	02-17
KX 125	92-93
KX 250	92-93



DMX061051 28,00€

KAWASAKI	
	Año
KX 125	94-02
KX 250	94-07
KX 500	94-04



DMX061151 28,00€

KAWASAKI	
	Año
KX 125	03-09



DMX061251 28,00€

KAWASAKI	
	Año
KX 250 F	04-05



DMX08072 28,00€

KAWASAKI	
	Año
KX 250 F	06-08



DMX08084 28,00€

KAWASAKI	
	Año
KX 250 F	09-16



DMX061191 28,00€

KAWASAKI	
	Año
KX 450 F	06-08
KLX 450 R	08-09



DMX08085 28,00€

KAWASAKI	
	Año
KX 450 F	09-15



DMX08530 28,00€

KAWASAKI	
	Año
KX 450 F	2016



DMX08086 28,00€

KTM	
	Año
65 SX	09-16
65 XC	2009



DMX061371 28,00€

KTM	
	Año
85 SX	03-16
105 SX	03-16



DMX08061 28,00€

KTM	
	Año
85 SX	03-14
105 SX	04-11



DMX08531 28,00€

KTM	
	Año
250 SX-F	2016
350 SX-F	2016
350 XC-F	2016



DMX08532 28,00€

KTM	
	Año
125 SX	2016
450 SX-F	2016
450 XC-F	2016



XPEED

Protector pedal de freno trasero

Referencia	€
DMX05950	5,68

RUEDAS Y NEUMÁTICOS

MOTOR

ADMISIÓN / ESCAPE
REFRIGERACIÓN

ELÉCTRICO

SUSPENSIÓN / DIRECCIÓN

FRENOS

TRANSMISIÓN

CONTROLES Y MANDOS

CHASIS

ACCESORIOS

CONTROLES Y MANDOS



DMX08063 28,00€

KTM

Año	
05-08	250 SX
05-15	250 SX-F
2006	250 SXS
11-15	250 XC-F
06-11	250 XC-W
12-15	250 XCF-W
2005	300 EXC
06-15	300 XC
06-15	300 XC-W



DMX061211 28,00€

KTM

Año	
01-15	125 SX
07-08	144 SX
09-15	150 SX
09-14	150 XC
98-04	200 SX
06-16	200 XC-W
01-03	250 EXC
06-08	250 EXC-F
06-15	250 SX
05-15	250 SX-F
99-06	250 SXS

06-16	250 XC
07-09	250 XC-F
06-15	250 XC-W
07-10	250 XCF-W
98-05	300 EXC
04-06	400 EXC
2008	450 XC-F
07-08	505 SX-F
08-09	505 XCF
06-07	525 EXC
06-07	525 SX
06-07	525 XC
2008	530 EXC
01-06	530 SXS



DMX061221 28,00€

KTM

Año	
07-11	400 XC
2004	450 EXC-G
08-15	450 SX-F
12-15	450 XC-W
05-06	525 EXC
05-06	525 SX



DMX08528 28,00€

SHERCO

Año	
14-16	250 SE-R
14-16	300 SE-R



DMX061341 28,00€

SUZUKI

Año	
89-01	RM 80
02-15	RM 85



DMX061061 28,00€

SUZUKI

Año	
93-08	RM 125
89-93	RM 250



DMX061081 28,00€

SUZUKI

Año	
94-08	RM 250
95-98	RMX 250



DMX061251 28,00€

SUZUKI

Año	
04-06	RMZ 250



DMX08076 28,00€

SUZUKI

Año	
07-16	RMZ 250



DMX061241 28,00€

SUZUKI

Año	
89-98	RMX 250
00-07	DRZ 400 E
00-15	DRZ 400 S
05-15	DRZ 400 SM



DMX08067 28,00€

SUZUKI

Año	
05-07	RMZ 450



DMX08077 28,00€

SUZUKI

Año	
08-16	RMZ 450



DMX08075 28,00€

YAMAHA

Año	
93-01	YZ 80
02-17	YZ 85
96-04	YZ 125
94-98	YZ 250



DMX061171 28,00€

YAMAHA

Año	
05-17	YZ 125
05-17	YZ 250
2016	YZ 250 X



DMX08060 28,00€

YAMAHA

Año	
99-04	YZ 250



DMX08074 28,00€

YAMAHA

Año	
01-13	YZ 250 F
01-13	WR 250 F



DMX061091 28,00€

YAMAHA

Año	
98-99	WR 450 F
98-99	YZ 400
00-02	YZ 426
00-02	WR 426 F
03-04	YZ 450
03-13	WR 450 F
03-13	YZ 450 F



DMX08071 28,00€

YAMAHA

Año	
06-13	YZ 450 F



DMX08518 32,00€

YAMAHA

Año	
14-16	YZ 450 F
14-16	YZ 250 F

CHASIS



XPEED

Protector de aluminio para cárter

Construidos en aluminio de alta calidad, con un espesor de 4,5mm. Cubre totalmente el motor, garantizando la máxima protección contra impactos y proyecciones de piedras.

Artículo bajo pedido, con plazo de entrega de 3 semanas.



€
88,45

AJP	Año	Referencia
PR3 125 Enduro	2010	P59076
PR3 125 Enduro	14-15	P59076
PR3 125 Enduro Pro	2010	P59076
PR3 125 Enduro Pro	14-15	P59076
PR3 125 Supermoto	2010	P59076
PR3 125 Supermoto	14-15	P59076
PR3 125 Supermoto Pro	2010	P59076
PR3 125 Trail	2014	P59076
PR4 125 Enduro	2010	P59076
PR4 125 Enduro	14-15	P59076
PR4 125 Enduro Pro	2010	P59076
PR4 125 Enduro Pro	14-15	P59076
PR4 125 Supermoto	2010	P59076
PR4 125 Supermoto	14-15	P59076
PR4 125 Supermoto Pro	2010	P59076
PR3 200 Enduro	2010	P59076
PR3 200 Enduro Pro	2010	P59076
PR3 200 MX	2010	P59076
PR3 200 MX Pro	2010	P59076
PR3 200 Supermoto	2010	P59076
PR3 200 Supermoto Pro	2010	P59076
PR4 200 Enduro	2010	P59076
PR4 200 Enduro Pro	2010	P59076
PR4 200 Supermoto	2010	P59076
PR4 200 Supermoto Pro	2010	P59076
PR3 240 Enduro	14-15	P59076
PR3 240 Enduro Pro	14-15	P59076
PR3 240 MX Pro	14-15	P59076
PR3 240 Supermoto	14-15	P59076
PR4 240 Enduro	14-15	P59076
PR4 240 Enduro Pro	14-15	P59076
PR4 240 Extreme	14-15	P59076
PR4 240 Supermoto	14-15	P59076
PR5 250 Enduro	14-15	P59118
PR5 250 Extreme	14-15	P59118
PR5 250 Supermoto	2015	P59118

APRILIA	Año	Referencia
RXV 450	09-11	P59082
RXV 550	09-11	P59082

BETA	Año	Referencia
ALP 4.0	10-14	P59136
RE 4T 125	08-14	P59149
RR 4T 125	08-14	P59149
RR 4T 125	2015	P59157
RR 4T 125 LC	10-15	P59127
RR 2T 250	13-15	P59116
RR 4T 250	05-07	P59023
RR 2T 300	13-15	P59116
X-Trainer 300	2015	P59150
RR 4T 350	11-14	P59080
RR 4T 350 Efi	2015	P59080
RR 4T 390	2015	P59080
RR 4T 400	05-09	P59023
RR 4T 400	10-14	P59080
RR 4T 430	2015	P59080
RR 4T 450	05-09	P59023
RR 4T 450	10-14	P59080
RR 4T 480	2015	P59080
RR 4T 498	12-14	P59080

RR 4T 520	10-11	P59080
RR 4T 525	05-09	P59023

BMW	Año	Referencia
G 450 X	09-10	P59081

GAS GAS	Año	Referencia
EC 125	01-09	P59007
EC 125	10-11	P59067
EC 125	12-13	P59123
MC 125	01-07	P59007
EC 200	00-09	P59008
EC 200	2010	P59055
EC 200	2011	P59073
EC 200	12-13	P59088
EC 250	00-09	P59008
EC 250	2010	P59055
EC 250	2011	P59073
EC 250	12-13	P59088
EC 250	14-15	P59129
EC 250F	10-11	P59052
EC 250F	12-13	P59096
MC 250	00-09	P59008
EC 300	00-09	P59008
EC 300	2010	P59055
EC 300	2011	P59073
EC 300	12-13	P59088
EC 300	14-15	P59129
EC 450F	2009	P59105
EC 450F	12-13	P59117

HONDA	Año	Referencia
CRF 150 R	07-09	P59113
CRF 150 R	12-13	P59113
CRF 230 F	07-11	P59006
CR 250 R	02-07	P59091
CRF 250 L	13-14	P59135
CRF 250 M	2014	P59135
CRF 250 R	04-09	P59005
CRF 250 R	2010	P59064
CRF 250 R	11-13	P59075
CRF 250 R	14-15	P59126
CRF 250 X	04-14	P59004
CRF 450 R	02-04	P59044
CRF 450 R	05-08	P59002
CRF 450 R	09-12	P59049
CRF 450 R	13-15	P59114
CRF 450 X	05-14	P59003

HUSABERG	Año	Referencia
TE 125	12-14	P59063
TE 125	12-14	P59063A
FE 250	2013	P59109
FE 250	2014	P59111A
TE 250	2012	P5969A
TE 250	13-14	P59133
TE 300	2012	P5969A
TE 300	13-14	P59133
FE 350	2013	P59084
FE 350	2014	P59111A
FE 390	10-12	P59047
FE 450	06-08	P59021
FE 450	09-12	P59047

FE 450	2013	P59137
FE 501	2013	P59137
FE 550	06-08	P59021
FE 570	09-12	P59047
FE 650	06-08	P59021

HUSQVARNA	Año	Referencia
TC 85	2016	P59154
CR 125	08-12	P59062
TE 125	2014	P59132
WR 125	08-12	P59062
FC 250	14-15	P59111A
FC 250	16-17	P59151
FE 250	14-16	P59111A
FE 250	2017	P59151
TC 250	04-07	P59012
TC 250	2008	P59013
TC 250	2010	P59056
TC 250	11-13	P59078
TE 250	04-07	P59012
TE 250	08-09	P59013
TE 250	2010	P59056
TE 250	11-13	P59078
TE 250	14-15	P59133
TE 250	2016	P59156
TE 250	2017	P59167
WR 250	08-13	P59048
TE 300	14-15	P59133
TE 300	2016	P59156
TE 300	2017	P59167
WR 300	09-13	P59048
TE 310	09-10	P59013
TE 310	11-13	P59078
FC 350	14-15	P59111A
FC 350	16-17	P59151
FE 350	14-16	P59111A
FE 350	2017	P59151
FE 350 S	2016	P59111A
TC 449	11-13	P59077
TE 449	11-13	P59077
FC 450	16-17	P59153
FE 450	2017	P59153
TC 450	04-07	P59012
TC 450	08-10	P59013
TE 450	04-07	P59012
TE 450	08-10	P59013
TC 510	05-07	P59012
TC 510	08-09	P59013
TE 510	04-07	P59012
TE 510	08-10	P59013
TE 510 R	2004	P59012
TE 511	11-13	P59077
TE 610	06-08	P59036

KAWASAKI	Año	Referencia
KX 85	04-13	P59112
KX 250 F	06-08	P59019
KX 250 F	2009	P59051
KX 250 F	10-16	P59065
KX 250 F	10-16	P59065A
KX 250 F	2017	P59173
KLX 450 R	08-15	P59001

XPEED

€
88,45

Protector de aluminio para cárter

Construidos en aluminio de alta calidad, con un espesor de 4,5mm.
Cubre totalmente el motor, garantizando la máxima protección contra impactos y proyecciones de piedras.

Artículo bajo pedido, con plazo de entrega de 3 semanas.

KTM	Año	Referencia
KX 450 F	06-08	P59045
KX 450 F	09-15	P59057
KX 450 F	16-17	P59152
65 SX	2014	P59130
85 SX	04-12	P59104
85 SX	13-15	P59120
85 SX	2016	P59154
125 EXC	04-07	P59040
125 EXC	08-16	P59063
125 EXC Six Days	2016	P59063
125 SX	04-06	P59040
125 SX	07-11	P59063
125 SX	12-15	P59107
125 SX	2016	P59164
150 SX	09-11	P59063
150 SX	12-15	P59107
150 SX	2016	P59164
150 XC	10-11	P59063
150 XC	12-14	P59107
200 EXC	04-07	P59040
200 EXC	08-16	P59063
200 SX	2004	P59040
200 XC-W	2016	P59063
250 EXC	01-07	P59079
250 EXC	04-07	P59035
250 EXC	08-10	P59037
250 EXC	2011	P5969A
250 EXC	12-16	P59133
250 EXC	2017	P59167
250 EXC Six Days	2016	P59133
250 EXC Six Days	2017	P59167
250 EXC-F	01-03	P59032
250 EXC-F	2007	P59027
250 EXC-F	08-11	P59039
250 EXC-F	12-13	P59109
250 EXC-F	14-16	P59122A
250 EXC-F	2017	P59171
250 EXC-F Six Days	2016	P59122A
250 EXC-F Six Days	2017	P59171
250 SX	01-06	P59079
250 SX	04-06	P59035
250 SX	07-10	P59037
250 SX	2011	P5969A
250 SX	12-14	P59100
250 SX-F	2006	P59027
250 SX-F	07-09	P59039
250 SX-F	2010	P59074
250 SX-F	2011	P59072
250 SX-F	2012	P59090
250 SX-F	13-14	P59119
250 SX-F	2015	P59111A
250 SX-F	16-17	P59151
250 XC-W	12-14	P59100
250 XC-W	2016	P59133
250 XC-W	2017	P59167
250 XC-F	2016	P59151
250 XCF-W	2016	P59122A
Freerider 250 R	14-15	P59146
300 EXC	01-07	P59079
300 EXC	04-07	P59035

300 EXC	08-10	P59037
300 EXC	2011	P5969A
300 EXC	12-16	P59133
300 EXC	2017	P59167
300 EXC Six Days	2016	P59133
300 EXC Six Days	2017	P59167
300 XC	12-14	P59100
300 XC-W	2016	P59133
300 XC-W Six Days	2016	P59133
300 XC-W	2017	P59167
350 EXC-F	12-14	P59084
350 EXC-F	15-16	P59122A
350 EXC-F	2017	P59171
350 EXC-F Six Days	2016	P59122A
350 EXC-F Six Days	2017	P59171
350 EXCF-W Six Days	2016	P59122A
350 SX-F	11-15	P59070
350 SX-F	16-17	P59151
350 XC-F	12-14	P59111A
350 XC-F	16-17	P59151
350 XCF-W	2016	P59122A
400 EXC-F	01-02	P59032
400 EXC-F	04-07	P59033
400 EXC-F	09-11	P59030
400 SX-F	00-02	P59032
450 EXC-F	2003	P59032
450 EXC-F	04-07	P59033
450 EXC-F	08-11	P59030
450 EXC-F	12-16	P59137
450 EXC-F	2017	P59168
450 EXC-F Six Days	2016	P59137
450 EXC-F Six Days	2017	P59168
450 SX-F	03-06	P59033
450 SX-F	07-10	P59031
450 SX-F	11-12	P59071
450 SX-F	13-14	P59137
450 SX-F	16-17	P59153
450 XC-F	16-17	P59153
450 XC-W	2016	P59137
500 EXC	12-16	P59137
500 EXC	2017	P59168
500 EXC Six Days	2016	P59137
500 EXC Six Days	2017	P59168
500 XC-W	2016	P59137
505 SX-F	07-08	P59031
525 EXC Racing	2003	P59032
525 EXC Racing	04-07	P59033
525 SX Racing	03-06	P59033
530 EXC-F	08-11	P59030

SHERCO	Año	Referencia
SE 250	14-15	P59099
SE 250R	14-16	P59099
SE 250R	2017	P59175
SE 250R Factory	2016	P59099
SE 250R Six Days	2017	P59175
SEF 250	12-14	P59092
SEF 250	2015	P59134

SEF 250R	12-14	P59092
SEF 250R	15-16	P59134
SEF 250R Factory	2016	P59134
SEF 250R Six Days	2016	P59134
SE 300	14-15	P59099
SE 300R	14-16	P59099
SE 300R	2017	P59175
SE 300R Factory	2016	P59099
SE 300R Six Days	2016	P59099
SE 300R Six Days	2017	P59175
SEF 300	12-14	P59092
SEF 300	2015	P59134
SEF 300R	12-14	P59092
SEF 300R	2015	P59134
SEF 300R Factory	2016	P59134
SEF 300R Six Days	2016	P59134

SUZUKI	Año	Referencia
RM 85	02-12	P59106
RM 85	2015	P59106
RM 85 L	02-12	P59106
RM 85 L	2015	P59106
RM-Z 250	07-09	P59009
RM-Z 250	10-13	P59059
RM-Z 250	10-14	P5959A
RM-Z 250	2015	P59138
RM-Z 250	2016	P59160
RM-Z 250	2017	P59172
DR-Z 400	00-04	P59068
DR-Z 400 E	00-07	P59068
DR-Z 400 S	00-15	P59068
DR-Z 400 SM	05-15	P59068
RM-Z 450	05-07	P59010
RM-Z 450	08-09	P59011
RM-Z 450	10-13	P59058
RM-Z 450	10-15	P5958A
RM-Z 450	16-17	P59161
RMX 450Z	10-11	P59060
RMX 450Z	2017	P59060

TM	Año	Referencia
MX 85	2015	P59166
EN 125	08-15	P59041
EN 125	2016	P59158
MX 125	08-15	P59041
MX 125	2016	P59158
EN 144	09-15	P59041
EN 144	2016	P59158
MX 144	08-15	P59041
MX 144	2016	P59158
EN 250	04-07	P59022
EN 250	08-10	P59038
EN 250	11-14	P59125
EN 250	2015	P59147
EN 250	2016	P59155
EN 250F	08-10	P59050
EN 250 Fi	10-14	P59159
EN 250 Fi	2015	P59148
EN 250 Fi	2016	P59170
MX 250	04-07	P59022
MX 250	08-10	P59038
MX 250	11-14	P59125

RUEDAS Y NEUMÁTICOS

MOTOR

ADMISIÓN / ESCAPE
REFRIGERACIÓN

ELECTRICO

SUSPENSIÓN / DIRECCIÓN

FRENOS

TRANSMISIÓN

CONTROLES Y MANDOS

CHASIS

ACCESORIOS

XPEED

Protector de aluminio para cárter

Construidos en aluminio de alta calidad, con un espesor de 4,5mm. Cubre totalmente el motor, garantizando la máxima protección contra impactos y proyecciones de piedras.

€
88,45

Artículo bajo pedido, con plazo de entrega de 3 semanas.

MX 250	2015	P59147
MX 250 F	08-10	P59050
MX 250 Fi	10-14	P59050
EN 300	04-07	P59022
EN 300	08-10	P59038
EN 300	11-14	P59125
EN 300	2015	P59147
EN 300	2016	P59155
MX 300	04-07	P59022
MX 300	08-10	P59038
MX 300	11-14	P59125
MX 300	2015	P59147
EN 450 F	08-10	P59050
EN 450 Fi	10-14	P59050
MX 450 F	08-10	P59050
MX 450 Fi	10-14	P59050
EN 530 F	08-14	P59050
MX 530 F	08-14	P59050

WR 450 F	07-11	P59015
WR 450 F	12-15	P59098
WR 450 F	2016	P59163
YZ 450 F	06-09	P59018
YZ 450 F	10-13	P59061
YZ 450 F	14-16	P59124

YAMAHA	Año	Referencia
YZ 85	04-15	P59110
WR 250 F	07-14	P59014
WR 250 F	15-16	P59145
YZ 250	05-16	P59017
YZ 250 F	06-09	P59016
YZ 250 F	10-13	P59054
YZ 250 F	14-16	P59128
WR 450 F	03-06	P59066



€
67,45

€
74,20



XPEED Protector radiador

El protector de radiador se ha diseñado especialmente para proteger su sistema de refrigeración. Asegura un perímetro de protección alrededor del radiador. Con este perímetro de seguridad los impactos no afectarán a su radiador. Fabricado en aluminio de alta calidad con un espesor de 3mm

* Protector radiador sin ventilador "P60167"

** Protector radiador con ventilador "P60168"

Artículo bajo pedido, con plazo de entrega de 3 semanas.

Para colores añadir la letra correspondiente detrás de la referencia. Se entregan bajo pedido en un plazo de 3 semanas.

NEGRO	N
AZUL	B
ROJO	R
BLANCO	W
AMARILLO	Y
NARANJA	O
VERDE	G

AJP	Año	Referencia
PR5 250 Enduro	14-15	P60118
PR5 250 Extreme	14-15	P60118
PR5 250 Supermoto	2015	P60118

APRILIA	Año	Referencia
RXV 450	09-11	P60082
RXV 550	09-11	P60082

BETA	Año	Referencia
RR 2T 250	13-15	P60116
RR 4T 250	05-07	P60023
RR 2T 300	13-15	P60116
X-Trainer 300	2015	P60150
RR 4T 350	11-14	P60023
RR 4T 350 EFI	2015	P60023
RR 4T 390	2015	P60023
RR 4T 400	05-14	P60023
RR 4T 430	2015	P60023
RR 4T 450	05-14	P60023
RR 4T 480	2015	P60023
RR 4T 498	12-14	P60023
RR 4T 520	10-11	P60023
RR 4T 525	05-09	P60023

BMW	Año	Referencia
G 450 X	09-10	P60081

GAS GAS	Año	Referencia
EC 125	01-15	P60123
MC 125	02-07	P60123
EC 200	00-15	P60123
EC 250	00-15	P60123
EC 250F	10-15	P60123
MC 250	00-09	P60123
EC 300	00-15	P60123
EC 300F	13-15	P60123
EC 400F	02-03	P60123
EC 450F	03-15	P60123
EC 515F	08-09	P60123

HONDA	Año	Referencia
CRF 150R	07-09	P60113
CRF 150R	12-15	P60113
CR 250R	02-07	P60091
CRF 250L	13-14	P60135
CRF 250M	2014	P60135
CRF 250R	06-09	P60005
CRF 250R	10-13	P60064
CRF 250R	2014	P60126
CRF 250R	2015	P60143
CRF 250X	04-14	P60004

CRF 450R	05-08	P60002
CRF 450R	09-12	P60049
CRF 450R	13-14	P60114
CRF 450R	15-16	P60142
CRF 450X	05-07	P6003A
CRF 450X	08-14	P60003

HUSABERG	Año	Referencia
TE 125	12-14	P60141
FE 250	13-14	P6140A
TE 250	12-14	P60141
TE 300	12-14	P60141
FE 350	13-14	P6140A
FE 450	09-12	P60087
FE 450	13-14	P6140A
FE 501	13-14	P6140A
FE 570	09-12	P60087

HUSQVARNA	Año	Referencia
TC 85	2016	P6120A
CR 125	08-09	P60048
CR 125	10-13	P60056
TC 125	2014	P60141
TC 125	2015	P6140A
TE 125	2014	P60141
TE 125	2015	P6140A
WR 125	08-09	P60048
WR 125	10-13	P60056
FC 250	2014	P60141
FC 250	2015	P6140A
FC 250	16-17	P60151
FE 250	14-16	P6140A
FE 250	2017	P60167*
FE 250 2	2017	P60168**
TC 250	04-07	P60012
TC 250	2008	P60013
TC 250	10-13	P60056
TC 250	2014	P60141
TC 250	2015	P6140A
TE 250	04-07	P60012
TE 250	08-09	P60013
TE 250	10-13	P60056
TE 250	2014	P60141
TE 250	2015	P6140A
TE 250	2016	P60141
TE 250	2017	P60167
WR 250	08-09	P60048
WR 250	10-13	P60056
TE 300	2014	P60141
TE 300	2015	P6140A
TE 300	2016	P60141
TE 300	2017	P60167

WR 300	2009	P60048
WR 300	10-13	P60056
TE 310	2009	P60013
TE 310	11-13	P60078
FC 350	2014	P60141
FC 350	2015	P6140A
FC 350	16-17	P60151
FE 350	14-16	P6140A
FE 350	2017	P60167*
FE 350	2017	P60168**
FE 350 S	2016	P6140A
TC 449	11-13	P60077
TE 449	11-13	P60077
FC 450	2014	P60141
FC 450	2015	P6140A
FC 450	16-17	P60151
FE 450	14-16	P6140A
FE 450	2017	P60167*
FE 450	2017	P60168**
TC 450	04-07	P60012
TC 450	08-09	P60013
TE 450	04-07	P60012
TE 450	08-09	P60013
FE 501	14-16	P6140A
FE 501	2017	P60167*
FE 501	2017	P60168**
FE 501S	2016	P6140A
TC 510	05-07	P60012
TC 510	08-09	P60013
TE 510	04-07	P60012
TE 510	08-09	P60013
TE 510R	2004	P60012
TE 511	11-13	P60077
TE 610	06-08	P60036
TE 610E	2004	P60036

KAWASAKI	Año	Referencia
KX 85	04-14	P60112
KX 250 F	06-08	P60019
KX 250 F	2009	P60051
KX 250 F	10-16	P60065
KX 250 F	2017	P60173
KLX 450 R	08-15	P60045
KX 450 F	06-08	P60045
KX 450 F	2009	P60046
KX 450 F	10-11	P60057
KX 450 F	12-15	P60089
KX 450 F	16-17	P60152

RUEDAS Y NEUMÁTICOS

MOTOR

ADMISIÓN / ESCAPE REFRIGERACIÓN

ELECTRICO

SUSPENSIÓN / DIRECCIÓN

FRENOS

TRANSMISIÓN

CONTROLES Y MANDOS

CHASIS

ACCESORIOS

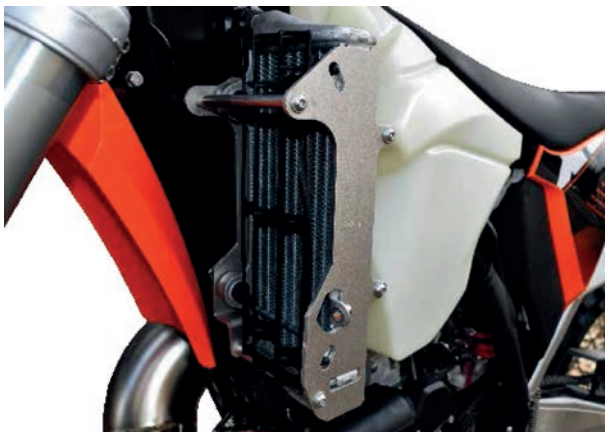

KTM	Año	Referencia
65 SX	2014	P60130
85 SX	03-16	P6120A
125 EXC	03-07	P60024
125 EXC	08-11	P60087
125 EXC	12-16	P60141
125 EXC Six Days	2016	P60141
125 SX	03-06	P60024
125 SX	07-10	P60087
125 SX	11-14	P60141
125 SX	2015	P6140A
125 SX	2016	P60151
144 SX	2008	P60087
150 SX	09-10	P60087
150 SX	11-14	P60141
150 SX	2015	P6140A
150 SX	2016	P60151
150 XC	2010	P60087
150 XC	11-14	P60141
200 EXC	03-07	P60024
200 EXC	08-11	P60087
200 EXC	12-16	P60141
200 SX	03-04	P60024
200 XC-W	15-16	P6140A
250 EXC	03-07	P60024
250 EXC	08-11	P60087
250 EXC	12-16	P60141
250 EXC	2017	P60167
250 EXC Six Days	2016	P60141
250 EXC Six Days	2017	P60167
250 EXC-F	2007	P60024
250 EXC-F	08-11	P60087
250 EXC-F	12-16	P6140A
250 EXC-F	2017	P60167*
250 EXC-F	2017	P60168**
250 EXC-F Six Days	2016	P6140A
250 EXC-F Six Days	2017	P60167*
250 EXC-F Six Days	2017	P60168**
250 SX	03-06	P60024
250 SX	07-10	P60087
250 SX	11-14	P60141
250 SX	2015	P6140A
250 SX Factory Edition	2015	P6140A
250 SX-F	2006	P60024
250 SX-F	07-10	P60087
250 SX-F	11-14	P60141
250 SX-F	2015	P6140A
250 SX-F	16-17	P60151
250 XC	11-14	P60141
250 XC	2015	P6140A
250 XC-F	11-14	P60141

250 XC-F	2015	P6140A
250 XC-F	16-17	P60151
250 XCF-W	15-16	P6140A
250 XC-W	15-16	P6140A
250 XC-W	2017	P60167
250 Freeride R	14-15	P60146
300 EXC	03-07	P60024
300 EXC	08-11	P60087
300 EXC	12-16	P60141
300 EXC	2017	P60167
300 EXC Six Days	2016	P60141
300 EXC Six Days	2017	P60167
300 EXC-W Six Days	2017	P60167
300 XC	11-14	P60141
300 XC	2015	P6140A
300 XC-W	15-16	P6140A
300 XC-W Six Days	15-16	P6140A
300 XC-W Six Days	2017	P60167
350 EXC-F	12-16	P6140A
350 EXC-F	2017	P60167*
350 EXC-F	2017	P60168**
350 SX-F	11-14	P60141
350 SX-F	2015	P6140A
350 SX-F	16-17	P60151
350 XC-F	11-14	P60141
350 XC-F	2015	P6140A
350 XC-F	16-17	P60151
350 XCF-W	15-16	P6140A
350 XCF-W Six Days	15-16	P6140A
350 XCF-W Six Days	2017	P60167*
350 XCF-W Six Days	2017	P60168**
400 EXC-F	05-07	P60033
400 EXC-F	09-11	P60087
450 EXC-F	05-07	P60033
450 EXC-F	08-11	P60087
450 EXC-F	12-16	P6140A
450 EXC-F	2017	P60167*
450 EXC-F	2017	P60168**
450 EXC-F Six Days	2016	P6140A
450 EXC-F Six Days	2017	P60167*
450 EXC-F Six Days	2017	P60168**
450 SX-F	05-06	P60033
450 SX-F	07-10	P60087
450 SX-F	11-14	P60141
450 SX-F	2015	P6140A
450 SX-F Factory Edition	2015	P6140A
450 SX-F	2016	P60151
450 XC-F	13-14	P60141
450 XC-F	2015	P6140A
450 XC-F	2016	P60151
450 XC-W	15-16	P6140A
500 EXC	12-16	P6140A

500 EXC	2017	P60167*
500 EXC	2017	P60168**
500 EXC Six Days	2016	P6140A
500 EXC Six Days	2017	P60167*
500 EXC Six Days	2017	P60168**
500 XC-W	15-16	P6140A
505 SX-F	2008	P60087
525 EXC RACING	05-07	P60033
525 SX RACING	05-06	P60033
530 EXC-F	08-11	P60087

SHERCO	Año	Referencia
SE 250	14-15	P60099
SE 250R	14-16	P60099
SE 250R	2017	P60175
SE 250R Factory	2016	P60099
SE 250R Six Days	2016	P60099
SE 250R Six Days	2017	P60175
SEF 250	12-14	P6092A
SEF 250	2015	P6134A
SEF 250R	12-14	P6092A
SEF 250R	15-16	P6134A
SEF 250R Factory	2016	P6134A
SEF 250R Six Days	2016	P6134A
SE 300	14-15	P60099
SE 300R	14-16	P60099
SE 300R	2017	P60175
SE 300R Factory	2016	P60099
SE 300R Six Days	2016	P60099
SE 300R Six Days	2017	P60175
SEF 300	12-14	P6092A
SEF 300	15-16	P6134A
SEF 300R	12-14	P6092A
SEF 300R	2015	P6134A
SEF 300R Factory	2016	P6134A
SEF 300R Six Days	2016	P6134A

SUZUKI	Año	Referencia
RM 85	02-12	P60106
RM 85	2015	P60106
RM 85L	02-10	P60106
RM 85L	2012	P60106
RM-Z 250	07-09	P60009
RM-Z 250	10-17	P6059A
DR-Z 400	00-04	P60068
DR-Z 400E	00-07	P60068
DR-Z 400S	00-15	P60068
DR-Z 400SM	05-09	P60068
DR-Z 400SM	13-15	P60068
RM-Z 450	05-07	P60010
RM-Z 450	08-09	P60011
RM-Z 450	10-17	P6058A
RMX 450Z	10-11	P6058A
RMX 450Z	2017	P6058A



XPEED Protector radiador

* Protector radiador sin ventilador "P60167**"

** Protector radiador con ventilador "P60168**"

TM	Año	Referencia
MX 85	2015	P60166
EN 125	04-07	P60022
EN 125	08-14	P60041
EN 125	2015	P60147
EN 125	2016	P60158
MX 125	08-14	P60041
MX 125	2015	P60147
MX 125	2016	P60158
EN 144	09-14	P60041
EN 144	2015	P60147
EN 144	2016	P60158
MX 144	08-14	P60041
MX 144	2015	P60147
MX 144	2016	P60158
EN 250	04-07	P60022
EN 250	08-14	P60041
EN 250	2015	P60147
EN 250	2016	P60155
EN 250F	09-10	P60050
EN 250Fi	10-14	P60159
EN 250Fi	15-16	P60148
MX 250	04-07	P60022
MX 250	08-14	P60041
MX 250	2015	P60147
MX 250F	09-10	P60050
MX 250Fi	10-14	P60050
EN 300	04-07	P60022
EN 300	08-14	P60041
EN 300	2015	P60147
MX 300	04-07	P60022
MX 300	08-14	P60041
MX 300	2015	P60147
EN 450F	09-10	P60050
EN 450Fi	10-14	P60050
MX 450F	09-10	P60050
MX 450Fi	10-14	P60050
EN 530F	09-14	P60050
MX 530F	09-14	P60050

YAMAHA	Año	Referencia
YZ 85	02-15	P60110
YZ 125	05-16	P60017
WR 250 F	07-14	P60014
WR 250 F	2015	P60145
WR 250 F	15-16	P6145A
YZ 250	05-16	P60017
YZ 250 F	06-09	P60016
YZ 250 F	10-13	P6054A
YZ 250 F	14-16	P60124
WR 450 F	03-06	P60066
WR 450 F	07-11	P60014
WR 450 F	12-15	P60098
WR 450 F	2016	P60163
YZ 450 F	06-09	P60018
YZ 450 F	10-13	P6061A
YZ 450 F	14-16	P60124

RUEDAS Y NEUMÁTICOS

MOTOR

ADMISIÓN / ESCAPE
REFRIGERACIÓN

ELÉCTRICO

SUSPENSIÓN / DIRECCIÓN

FRENOS

TRANSMISIÓN

CONTROLES Y MANDOS

CHASIS

ACCESORIOS

Asientos completos y sus fundas

Los asientos completos tienen las sujeciones incluidas, la funda de asiento es antideslizante e impermeable. Disponemos de asientos estándar y asientos con 2,5 cm más altos para una mayor comodidad. También disponemos de asientos Racing para supermotard.

HONDA	Año	Descripción	Asiento Normal	Asiento 2,5cm más alto	Asiento Racing
CR 125	00-07	asiento completo funda recambio	DMX04464 DMX04464B	DMX044642 DMX044642B	
CR 250	00-07	asiento completo funda recambio	DMX04464 DMX04464B	DMX044642 DMX044642B	
CRF 250 R	04-09	asiento completo funda recambio	DMX04465 DMX04465B	DMX044652 DMX044652B	
CRF 250 R	10-13	asiento completo funda recambio	DMX04474 DMX04474B	DMX044742 DMX044742B	
CRF 250 R	14-17	asiento completo funda recambio	DMX04477 DMX04477B	DMX044772 DMX044772B	
CRF 450 R	05-08	asiento completo funda recambio	DMX04451 DMX04451B	DMX044512 DMX044512B	DMX044511 DMX044511B
CRF 450 R	09-12	asiento completo funda recambio	DMX04474 DMX04474B	DMX044742 DMX044742B	
CRF 450 R	13-17	asiento completo funda recambio	DMX04477 DMX04477B	DMX044772 DMX044772B	

KAWASAKI	Año	Descripción	Asiento Normal	Asiento 2,5cm más alto	Asiento Racing
KX 125	03-07	asiento completo funda recambio	DMX04462 DMX04462B	DMX044622 DMX044622B	
KX 250 F	04-05	asiento completo funda recambio	DMX04460 DMX04460B	DMX044602 DMX044602B	
KX 250 F	06-08	asiento completo funda recambio	DMX04452 DMX04452B	DMX044522 DMX044522B	
KX 250 F	09-12	asiento completo funda recambio	DMX04463 DMX04463B	DMX044632 DMX044632B	
KX 250 F	13-16	asiento completo funda recambio	DMX04480 DMX04480B		
KX 450 F	09-11	asiento completo funda recambio	DMX04463 DMX04463B	DMX044632 DMX044632B	
KX 450 F	12-15	asiento completo funda recambio	DMX04480 DMX04480B		

KTM	Año	Descripción	Asiento Normal	Asiento 2,5cm más alto	Asiento Racing
125 SX	11-13				
150 SX	11-13				
200 XC-W	12-13				
250 SX	11-13				
250 SX-F	11-13				
250 XC	11-13				
250 XC-F	11-13				
250 XC-W	12-13				
250 XCF-W	12-13				
300 XC	11-13	asiento completo	DMX04466	DMX044662	
300 XC-W	12-13	funda recambio	DMX04466B	DMX044662B	
350 EXC-F	12-13				
350 SX-F	11-13				
350 XC-F	11-13				
350 XCF-W	12-13				
450 SX-F	11-13				
450 XC-W	12-13				
500 EXC	12-13				
500 XC-W	12-13				

SUZUKI	Año	Descripción	Asiento Normal	Asiento 2,5cm más alto	Asiento Racing
RM 125	01-07	asiento completo	DMX04459	DMX044592	
RM 250	01-07	funda recambio	DMX04459B	DMX044592B	
RMZ 250	04-06	asiento completo funda recambio	DMX04460 DMX04460B	DMX044602 DMX044602B	
RMZ 450	05-07	asiento completo funda recambio	DMX04450 DMX04450B	DMX044502 DMX044502B	
RMZ 450	08-16	asiento completo funda recambio	DMX04471 DMX04471B	DMX044712 DMX044712B	

YAMAHA	Año	Descripción	Asiento Normal	Asiento 2,5cm más alto	Asiento Racing
YZ 125	02-14	asiento completo	DMX04454	DMX044542	
YZ 250	02-14	funda recambio	DMX04454B	DMX044542B	
YZ 250 F	03-05	asiento completo funda recambio	DMX04455 DMX04455B	DMX044552 DMX044552B	
YZ 250 F	06-09	asiento completo funda recambio	DMX04456 DMX04456B	DMX044562 DMX044562B	
YZ 250 F	10-13	asiento completo funda recambio	DMX04473 DMX04473B	DMX044732 DMX044732B	
YZ 250 F	14-17	asiento completo funda recambio	DMX04478 DMX04478B	DMX044782 DMX044782B	
WR 250 F	15-16	asiento completo funda recambio	DMX04478 DMX04478B	DMX044782 DMX044782B	
YZ 450 F	06-09	asiento completo funda recambio	DMX04456 DMX04456B	DMX044562 DMX044562B	
YZ 450 F	10-13	asiento completo funda recambio	DMX04472 DMX04472B	DMX044722 DMX044722B	
YZ 450 F	14-17	asiento completo funda recambio	DMX04478 DMX04478B	DMX044782 DMX044782B	

€
111

Asiento

€
41

Funda



RUEDAS Y NEUMÁTICOS



RUEDAS Y NEUMÁTICOS



holeshot



Holeshot MXR 4* / MXR 6**

Medida	Referencia	PR	Límite de carga (kg.)	Peso (kg.)	€
DELANTERO					
19x6-10**	532022	2	109	4,00	72,89
TRASERO					
18x10-8**	532023	2	132	5,60	74,54
19x10-9*	532064	2	132	5,70	74,54



QUAD MX



Quad Cross MX PRO

Medida	Referencia	PR	Límite de carga (kg.)	Peso (kg.)	€
DELANTERO					
20x6-10	560504	2	109	4,50	74,73
TRASERO					
18x10-8	560489	2	132	5,45	79,48



holeshot



Holeshot SX

Medida	Referencia	PR	Límite de carga (kg.)	Peso (kg.)	€
DELANTERO					
20x6-10	532019	2	109	4,20	76,43
TRASERO					
18x10-8	532018	2	132	5,50	78,43



holeshot



Holeshot SR

Medida	Referencia	PR	Límite de carga (kg.)	Peso (kg.)	€
DELANTERO					
21x7R-10	598106	4	30F	5,35	79,44
TRASERO					
20x10R-9	598107	4	39F	6,45	86,94



holeshot



Holeshot XCR

Medida	Referencia	PR	Límite de carga (kg.)	Peso (kg.)	€
DELANTERO					
22x7-10	532008	6	125	6	82,45
TRASERO					
20x11-8	532053	6	160	6,85	79,84
20x11-9	598010	6	160	6,75	92,16



holeshot



Holeshot XCT

Medida	Referencia	PR	Límite de carga (kg.)	Peso (kg.)	€
TRASERO					
22x11-9	532038	6	180	9,00	88,85



QUAD XC



Quad Cross XC

Medida	Referencia	PR	Límite de carga (kg.)	Peso (kg.)	€
DELANTERO					
22x7-10	560546	6	125	6,00	78,27
TRASERO					
20x11-9	560547	6	160	7,35	90,61



GNCC
holeshot



Holeshot GNCC

Medida	Referencia	PR	Límite de carga (kg.)	Peso (kg.)	€
DELANTERO					
21x7-10	532029	6	125	6,30	109,59
22x7-10	598011	6	125	6,60	115,08
TRASERO					
20x10-9	598012	6	160	7,00	132,13
21x11-9	532027	6	160	8,00	132,13

● Homologado ITV

Los neumáticos que no tengan el punto ● no pueden utilizarse para asfalto. Precios validos hasta el 31/04/2018

INNOVA

Power Gear



Medida	Referencia	PR	Límite de carga (kg.)	Peso (kg.)	€
● 18x10-8	A800208	4	38N	5,85	55,88
20x10-8	A8002E1	4		5,85	57,56
● 20x11-8	A8002E2	4	38J	6,10	67,20
● 22x11-8	A800287	4	42J	7,35	73,57
● 20x10-9	A8002A6	4	50N	5,65	62,30
● 20x11-9	A8002A7	4	56N	6,25	65,03
● 22x11-9	A800239	4	62N	7,20	71,33
● 20x11-10	A8002F2	4	37J	6,90	68,85
● 22x10-10	A8002A4	4	55N	6,60	66,37
● 22x11-10	A8002A5	4	60N	8,10	72,98

INNOVA

Speed Gear



Medida	Referencia	PR	Límite de carga (kg.)	Peso (kg.)	€
● 21x7-10	A8003A1	4	42N	4,55	51,67
● 22x7-10	A800309	4	45N	4,80	54,98
● 23x7-10	A800307	4	31J	5,40	68,52

INNOVA

Racer



Medida	Referencia	Límite de carga (kg.)	Peso (kg.)	€
DELANTERO				
● 180/80-8 (19x7-8)	A802278	20N	4,30	47,74
● 180/60-10 (19x7-10)	A802297	27N	4,15	51,99
● 175/70-10 (21x7-10)	A8022A1	42N	4,80	67,39
● 185/80-10 (22x7-10)	A8022A2	45N	5,20	65,77
● 185/88-12 (25x8-12)	A802206	40N	6,90	76,38
TRASERO				
● 240/55-8 (18x9.5-8)	A802246	24N	4,80	62,97
● 255/65-8 (21x10-8)	A802213	50N	6,45	73,56
● 215/50-9 (20x10-9)	A8022A7	50N	6,70	73,57
● 255/65-9 (22x10-9)	A802239	56N	7,90	79,61
● 225/40-10 (18x10-10)	A802279	32N	5,45	62,11
● 255/60-10 (22x10-10)	A802255	55N	6,00	84,80
● 270/60-12 (25x10-12)	A802221	50N	9,25	93,79

INNOVA

Power Gear Enduro



Medida	Referencia	PR	Límite de carga (kg.)	Peso (kg.)	€
● 20x11-9	A8X02A7	4	38J	7,30	75,46
● 22x11-9	A8X0239	4	42J	7,4	83,45

CARLISLE

Turf Tamer



Medida	Referencia	PR	Límite de carga (kg.)	Peso (kg.)	€
TRASERO					
21x12-8	45U3B7	3	279	7,2	52,04
20x11-9	45U3A7	3	284	6,8	55,80

XPEED

X-100



Medida	Referencia	PR	Límite de carga (kg.)	Peso (kg.)	€
TRASERO					
22x10-9	X100238	6	45J	8,60	67,83
TRASERO					
22x10-9	X100238	6	45J	8,60	67,83

● Homologado ITV

Los neumáticos que no tengan el punto ● no pueden utilizarse para asfalto. Precios validos hasta el 31/04/2018

RUEDAS Y NEUMÁTICOS

CARLISLE

Trail Wolf



Medida	Referencia	PR	Límite de carga (kg.)	Peso (kg.)	€
DELANTERO					
19x8-8	537038	4	80	4,00	47,96
20x7-8	537039	2		5,00	55,00

INNOVA

Land Hawk



Medida	Referencia	PR	Límite de carga (kg.)	Peso (kg.)	€
DELANTERO					
18x7-7	A800777	2	6F	3,95	51,98
TRASERO					
● 16x8-7	A800787	2	28J		39,59

INNOVA

Knobby Gear



Medida	Referencia	PR	Límite de carga (kg.)	Peso (kg.)	€
● 145/70-6	A800919	2	1B	2,30	27,22
● 16x8-7	A800915	2	28J	2,80	36,50

XPEED

X-500



Medida	Referencia	PR	Límite de carga (kg.)	Peso (kg.)	€
22x10x8	X500286	2			61,82

ITP

TUNDRA CROSS

Tundra Cross



Medida	Referencia	PR	Límite de carga (kg.)	Peso (kg.)	€
DELANTERO					
25x9-12	560544	6	186	8,9	76,42

CARLISLE

489



Medida	Referencia	PR	Límite de carga (kg.)	Peso (kg.)	€
DELANTERO					
24x9-12	489342	3	120	8,0	68,44
● 25x8-12	560433	3	43F	6,9	82,48
TRASERO					
25x10-12	589339	3		9,0	92,31

ITP

XTR MUDLITE

Mud Lite XTR



Medida	Referencia	PR	Límite de carga (kg.)	Peso (kg.)	€
DELANTERO					
25x8R-12	560398	6	153	10,4	94,62
26x9R-12	560387	6	184	12,5	114,46
TRASERO					
25x10R-12	560399	6	75F	12,7	120,86

ITP

holeshot

Holeshot ATR



Medida	Referencia	PR	Límite de carga (kg.)	Peso (kg.)	€
DELANTERO					
25x8R12	598104	6		8,5	90,25
26x8R12	532072	6		9,0	98,96
TRASERO					
● 25x10R12	598105	6	53F	9,4	101,85
26x10R12	532073	6		10,0	105,54

● Homologado ITV

Los neumáticos que no tengan el punto ● no pueden utilizarse para asfalto. Precios validos hasta el 31/04/2018

ITP Terracross R/T 12" y 14"

Medidas	Referencia	PR	Límite de carga (kg.)	Peso (kg.)	€
DELANTERO					
25x8R-12	5E0423	6	153	11,0	119,41
26x9R-12	560475	6	74F	12,5	146,14
26x8R-14	560420	6	180	13,5	156,57
26x9R-14	560411	6	73F	14,9	161,08
TRASERO					
25x10R-12	5E0424	6	189	13,5	125,34
26x11R-12	560476	6	80F	14,9	158,60
26x11R-14	560412	6	79F	14,4	177,93



INNOVA Xtrem Lite

Medidas	Referencia	PR	Índice	Peso (kg.)	€
DELANTERO					
● 25x8-12	A804406	6	43N	8,6	98,84
● 26x8-14	A804420	6	44N	12,2	101,51
TRASERO					
● 25x10-12	A804421	6	50N	10,2	117,09
● 26x10-14	A804436	6	51N	12,9	122,83



ITP Blackwater Evolution

Medida	Referencia	PR	Límite de carga (kg.)	Peso (kg.)	€
DELANTERO					
26x9R-12	6P0041	8		11,6	164,43
27x9R-12	6P0064	8		11,9	186,91
27x9R-14	6P0062	8		12,5	187,24
28x9R-14	6P0113	8		13,4	196,37
TRASERO					
26x11R-12	6P0040	8		13,5	180,60
27x11R-12	6P0063	8		13,6	205,18
27x11R-14	6P0061	8		14,3	205,48
28x10R-14	6P0102	8		14,4	205,48
28x11R-14	6P0115	8		14,9	214,04
30x10R-14	6P0116	8		15,0	226,01



CARLISLE All Trail*/All Trail**

Medidas	Referencia	PR	Límite de carga (kg.)	Peso (kg.)	€
DELANTERO					
22x9.50-10**	55A3N1	4	320	7,2	115,14
23x8-12*	511506	4	280	8,8	109,72
25x8-12*	511507	4	335	9,2	112,34
TRASERO					
20x10.00-8**	510043	4	297	6,8	65,92
22x10.00-8**	510044	4	337	7,2	77,90
20x10.00-10**	510045	4	290	6,6	72,45
24x10.50-10**	55A3N9	4	372	8,2	155,01
22x11.00-10*	510016	4	368	8,9	72,49
23x10.50-12*	511505	4	345	10,8	113,37
25x10.50-12*	511508	4	410	11,3	115,05



*

**

● Homologado ITV

Los neumáticos que no tengan el punto ● no pueden utilizarse para asfalto. Precios validos hasta el 31/04/2018

RUEDAS Y NEUMÁTICOS

MOTOR

ADMISIÓN / ESCAPE
REFRIGERACIÓN

ELECTRICO

SUSPENSIÓN / DIRECCIÓN

FRENOS

TRANSMISIÓN

CONTROLES Y MANDOS

CHASIS

ACCESORIOS

ITP Mud Lite AT y XL

Medida	Referencia	PR	Límite de carga (kg.)	Peso (kg.)	€
DELANTERO					
AT 23x8-11	56A304	6			72,45
AT 24x8-11	56A332	6			75,64
AT 24x9-11	56A3A9	6	164	8,0	81,64
AT 24x8-12	560430	6	139	7,3	79,53
● AT 25x8-12	560542	6	43F	7,2	73,22
XL 25x8-12	560363	6	206	8,9	89,86
● XL 26x9-12	5EA3P6	6	49F	10,9	107,62
XL 27x9-12	56A380	6	198	11,0	118,03
TRASERO					
AT 22x11-10	56A3A5	6	173	8,0	87,14
AT 24x11-10	56A305	6	198	9,0	87,24
AT 25x11-10	56A308	6	206	8,8	94,69
AT 24x10-11	56A328	6			88,94
AT 25x10-11	56A322	6			96,36
● AT 25x10-12	560522	6	50F	8,9	86,99
XL 25x10-12	560364	6	206	10,6	107,48
● XL 26x10-12	5EA343	6	52F	11,0	106,00
XL 27x10-12	56A345	6	206	13,3	125,53
XL 27x12-12	56A347	6	206	13,9	131,39
XL 28x10-12	56A349	6	223	12	139,03
XL 28x12-12	56A350	6	254	15	148,52

XL AT



MUDLITE

XL AT



INNOVA Mud Gear

Medidas	Referencia	PR	Índice	Peso (kg.)	€
DELANTERO					
● AT 24x8-12	A800460	4	35L	8,7	91,43
● AT 25x8-12	A800406	4	35L	8,0	79,24
XL 26x8-12	A800375	6	46L	11,2	106,60
● XL 26x9-12	A800376	4	48N	12,2	127,20
● XL 27x9-12	A800380	4	51N	13,0	136,19
● XL 26x9-14	A800411	6	49L	13,6	140,68
TRASERO					
● AT 25x10-12	A800421	4	45L	9,0	88,26
● AT 25x11-12	A800422	6	53L	12,2	118,26
● XL 26x10-12	A800343	6	53L	12,9	128,04
● XL 26x12-12	A800361	4	56L	17,0	142,08
● XL 27x12-12	A800347	4	66L	17,8	169,60

● Homologado ITV

Los neumáticos que no tengan el punto ● no pueden utilizarse para asfalto. Precios validos hasta el 31/04/2018



Baja Cross

Medidas	Referencia	PR	Índice	Peso (kg.)	€
DELANTERO					
● 25x8R-12	560505	8	73D	11,0	159,33
● 26x9R-12	560563	8	79D	12,5	171,18
● 26x10R14	560536	8	81D	13,5	180,23
TRASERO					
● 25x10R-12	560506	8	80D	13,5	171,74
● 26x11R-12	560564	8	85D	15,0	181,04
● 26x11R-14	560523	8	84D	15,0	190,58
28x10R-14	560584	8		14,4	202,09



Baja Cross Sport

Medidas	Referencia	PR	Índice	Peso (kg.)	€
DELANTERO					
27x9R-14	6P0209	6		11,4	162,15
29x9R-14	6P0199	6		13,0	174,30
TRASERO					
27x11R-14	6P0210	6		13,3	179,21
29x11R-14	6P0200	6		15,5	184,43
30x10R-14	6P0087	8		15,6	235,30



Ultra Cross

Medidas	Referencia	PR	Índice	Peso (kg.)	€
27x10R-12	6P0251	8		14,3	188,86
27x9R-14	6P0492	8	88F	14,5	193,12
27x10R-14	6P0252	8		14,8	190,25
27x10R-15	560550	6	75F	14,2	200,55
28x10R-14	6P0254	8		15,0	199,76
29x9R-14	6P0317	8		15,2	183,03
29x11R-14	6P0318	8		16,5	193,81
30x10R-14	6P0083	8		16,0	235,30
30x10R-15	6P0255	8		16,0	221,66



● Homologado ITV

Los neumáticos que no tengan el punto ● no pueden utilizarse para asfalto. Precios validos hasta el 31/04/2018



RUEDAS Y NEUMÁTICOS

MOTOR

ADMISIÓN / ESCAPE
REFRIGERACIÓN

ELÉCTRICO

SUSPENSIÓN / DIRECCIÓN

FRENOS

TRANSMISIÓN

CONTROLES Y MANDOS

CHASIS

ACCESORIOS

€
29,74

ITP Complementos llanta

Precio para caja de 16 tuercas



ITP
W00020BX
M10x125



ITP
ALUG15BX
M10x125



ITP
ALUG16BX
M12x125



ITP
ALUG11BX
3/8" - 24



XPEED
DAT06079BX
M10x125



ITP
BLUG11BX
M10x125



XPEED
W00011BX
M10x125



ITP
ALUG14BX
M10x125



ITP
ALUG17BX
M10x150



ITP
ALUG18BX
M12x150



ITP
ALUG19BX
M12x125



ITP
ALUG13BX
3/8" - 24



unidad



1 unidad



1 unidad

Referencia	Descripción	€
C110SS	Ataque 110 y 115	8,20
C137SS	Ataque 137	8,20
C156SS	Ataque 156	8,20

Referencia	Descripción	€
P110SS	Ataque 110 y 115	8,20
P137SS	Ataque 137	8,20
P156SS	Ataque 156	8,20

Referencia	Descripción	€
C110SS	Ataque 110 y 115	8,20
C137SS	Ataque 137	8,20
C156SS	Ataque 156	8,20



4 unidades



Referencia	Descripción	€
P110BX	Ataque 110 y 115	27,00

Referencia	Descripción	€
W00412BX	4 Válvulas cromadas	7,60

Referencia	Descripción	€
DAT06079	4 tuercas M10x125	8,00



Referencia	Descripción	€
ALUG20BX	16 tuercas antirobo M12 x 150	34,92
ALUG21BX	16 tuercas antirobo M12 x 125	34,92



Referencia	Descripción	€
ALOCK110	4 tuercas antirobo M10x125	34,92

● Homologado ITV

Los neumáticos que no tengan el punto ● no pueden utilizarse para asfalto. Precios validos hasta el 31/04/2018

XPEED Llanta de aluminio

Dimensiones	Posición	Modelo	Referencia	Desplazamiento	Ataque
ARCTIC CAT DVX 400 04-08 // Honda 250EX 00-13 / 300EX 93-12 / 400EX 99-13 / 450R 04-13 // Kawasaki KFX 400 03-05 / KFX 450 08-13 // Suzuki LTZ 250 02-12 / LTZ 400 03-12 / LTR 450 06-09 // Gas Gas 50 / 300 / 450 // Can-Am DS 450 07-13 (ALUG17BX)					
10x5.5	Delantera	X-WIND	W10044	3.5+2	4/144
10x8	Trasera	X-WIND	W10110	3.5+4.5	4/110
10x5.5	Delantera	X-FLY	W11044	3.5+2	4/144
9x8	Trasera	X-FLY	W11910	3+5	4/110
10x8	Trasera	X-FLY	W11110	3.5+4.5	4/110
Yamaha 250 Raptor 08-13 / 350 Banshee 91-07 / 350 Warrior 87-04 / 350R 04-14 / 660R 01-05 / YFZ 450 04-14 / YFZ 450 R 09-15 / Raptor 700 06-15					
10x5.5	Delantera	X-WIND	W10056	3.5+2	4/156
10x8	Trasera	X-WIND	W10115	3.5+4.5	4/115
10x5.5	Delantera	X-FLY	W11056	3.5+2	4/156
9x8	Trasera	X-FLY	W11915	3+5	4/115
Aeon 180 / Sporty 200					
10x5.5	Delantera	X-WIND	W10010	3.5+2	4/110
10x5.6	Delantera	X-FLY	W11010	3.5+3	4/156
10x8	Trasera	X-FLY	W11111	3.5+4.5	4/110

€
59,80

NOTA:
Estas llantas deben usar tornillos cónicos.
DAT06079BX - 16 unidades - € 29,74€
DAT06079 - 4 unidades - € 8,00€



X-Wind



X-Fly

ITP Llanta de aluminio SS112

Dimensiones	Desplazamiento	Ataque	SS112 Mecanizada	€	SS112 Cromadas	€	Caja 16 tornillos	€
ARCTIC CAT DVX 400 04-08 // Honda 250EX 00-13 / 300EX 93-12 / 400EX 99-13 / 450R 04-13 // Kawasaki KFX 400 03-05 / KFX 450 08-14 // Suzuki LTZ 250 02-12 / LTZ 400 03-12 / LTR 450 06-09 // Gas Gas 50 / 300 / 450 // Can-Am DS 450 07-13 (ALUG17BX)								
10x5 Del.	3 + 2	4/144	10SS10	90,27	10SC10	110,56	ALUG14BX	29,74
9x8 Tras.	3 + 5	4/110	98SS14	95,09			ALUG14BX	29,74
10x8 Tras.	3 + 5	4/110	10SS11	102,29	10SC11	115,25	ALUG14BX	29,74
Yamaha 250 Raptor 08-13 / 350 Banshee 91-07 / 350 Warrior 87-04 / 350R 04-14 / 660R 01-05 / YFZ 450 04-14 / YFZ 450 R 09-15 / Raptor 700 06-15								
10x5 Del.	3 + 2	4/156	10SS12	90,27	10SC12		ALUG15BX	29,74
9x8 Tras.	3 + 5	4/115	98SS15	95,09			ALUG15BX	29,74
10x8 Tras.	3 + 5	4/115	10SS13	102,29	10SC13	94,72	ALUG15BX	29,74



SS112 (Mecanizadas)

SS112 (Cromadas)

ITP Llanta de aluminio Baja / Track-Lock



X-Baja

Baja

	Dimensiones	Posición	Referencia	Desplazamiento	Ataque	€	Caja 16 tornillos	€
Cannondale 440 01-03 // Honda 250R 86-89 / 250EX 00-14 / 300EX 93-13 / 400EX '99-14 / 450R 04-14 // Kawasaki KFX 400 03-06 // Suzuki LTZ400 03-14 / LTR 450 06-09 // Gas Gas 50 / 300 / 450								
X-Baja	10x5	Delantera	R105144	3+2	4/144	99,23	DAT06079BX	29,74
	9x8	Trasera	R098110	3+5	4/110	86,95	DAT06079BX	29,74
	10x5	Delantera	BR1542	3+2	4/144	151,42	ALUG20BX	29,74
Baja	8x8.5	Trasera	BR8941	3+5.5	4/110	120,38	ALUG20BX	29,74
	9x9	Trasera	BR9141	3+6	4/110	131,34	ALUG20BX	29,74
Kawasaki KFX 700 03-09								
Baja	10x5	Delantera	BR1542	3+2	4/144	152,07	ALUG20BX	29,74
	9x9	Trasera	BR9137	3+6	4/137	131,34	ALUG20BX	29,74
Yamaha 250 Raptor 08-14 / 350 Banshee 91-06 / 350 Warrior 87-04 / 350 Raptor 04-14 / YFZ 450 04-14 / YFZ 450R 09-15 / 660 Raptor 01-05 / Raptor 700 06-15								
X-Baja	10x5	Delantera	R105156	3+2	4/156	99,23	DAT06079BX	29,74
	9x8	Trasera	R098115	3+5	4/115	86,95	DAT06079BX	29,74
	10x5	Delantera	BR1552	3+2	4/156	151,42	ALUG20BX	29,74
Baja	8x8.5	Trasera	BR8942	3+5.5	4/115	120,38	ALUG20BX	29,74
	9x9	Trasera	BR9142	3+6	4/115	131,34	ALUG20BX	29,74
Track-Lock	8x8*	Trasera	TL8842	3+5	4/115	156,06	ALUG20BX	29,74



Llanta de aluminio 12" / 14"

SS106 / SS112 / SS212 / SS312



SS106
12x7" 69,99€
14x6" 69,99€
14x8" 69,99€
(Mecanizadas)



SS112
12x7" 95,91€
14x6" 107,60€
14x8" 116,92€
(Mecanizadas)



SS112C
12x7" 155,66€
14x6" 155,66€
14x8" 155,66€
(Cromadas)



SS212
12x7" 103,58€
14x6" 116,21€
14x8" 126,27€
(Mecanizadas)



SS212B
12x7" 103,58€
14x6" 116,21€
14x8" 126,27€
(Negra)



SS312
12x7" 103,58€
14x6" 116,21€
14x8" 126,27€
(Mecanizadas)



Hurricane
12x7" 106,68€
(Negra)

Dimensiones	Desplazamiento	Ataque	SS106 Mecanizada	SS112 Mecanizada	SS112C Cromada	SS212 Mecanizada	SS212B Negra	SS312 Mecanizada	Hurricane Negra	Tornillos Cromados
BOMBARDIER Traxter / Quest 650 // HONDA 300 4x4 / Rancher 350 S-ES / Rancher 400 -420 4x4 / Foreman 400 / Foreman 450-500 S-ES / Rubicon 500 // KYMCO MXU 500 // SUZUKI Eiger / King Quad 400 / Vinson // YAMAHA Grizzly 350 / Bruin 350 / Wolverine 350 / Big Bear 350 -400 / Kodiak 400-450 / Grizzly 600										
12x7 Del.	5+2	4/110		12SS30	12SS70			12SS700		ALUG14BX
12x7 Tras.	2+5	4/110	12SS11*	12SS31*	12SS71*			12SS701*		ALUG14BX
14x6 Del.	4+2	4/110		14SS30	14SS70	14SS300				ALUG14BX
14x8 Tras.	3+5	4/110		14SS31*	14SS71*	14SS301*				ALUG14BX
HONDA Rincon 650 - 680 // KAWASAKI Brute Force 650i / Brute Force 750 // SUZUKI King Quad 450 -700 - 750 // YAMAHA Kodiak 400 -450 / Grizzly 400 - 450 - 660 / Rhino 450 - 660 - 700 * Si se requiere una mayor anchura (entre 5 y 7 cm por llanta) superior en el eje trasero sobre el delantero, montar las llantas trasera del apartado superior marcadas con asterisco (*)										
12x7 Del.	5+2	4/110		12SS30		12SS300	12SS400	12SS700		ALUG14BX
12x7 Tras.	5+2	4/110		12SS30		12SS300	12SS400	12SS700		ALUG14BX
14x6 Del.	4+2	4/110		14SS30	14SS70	14SS300				ALUG14BX
14x8 Tras.	5+3	4/110	14SS12	14SS32	14SS72	14SS302				ALUG14BX
ARCTIC CAT 300i / 400i / 500i / 650i / 700i / 1000										
12x7 Del.	5+2	4/115				12SS309		12SS709		ALUG14BX
12x7 Tras.	5+2	4/115				12SS309		12SS709		ALUG14BX
14x6 Del.	4+2	4/115								ALUG14BX
14x8 Tras.	5+3	4/115								ALUG14BX
CAN-AM Outlander 330/400/500/650/800/1000 / Renegade 500/800/1000 / Commander 800/1000										
12x7 Del.	4+3	4/137						12SS706		ALUG15BX
12x7 Tras.	4+3	4/137						12SS706		ALUG15BX
12x7 Del./Tras.	5+2	4/137							12RB118	
14x6 Del.	4+2	4/137						14SS706		ALUG15BX
14x7 Del./Tras.	5+2	4/137								
14x8 Tras.	5+3	4/137						14SS711		ALUG15BX
KAWASAKI Prairie 360 / 400 / 650 / 700 / Brute Force 650 / Mule 500/600/610 // SUZUKI Twin Peaks 700										
12x7 Del.	4+3	4/137								ALUG15BX
12x7 Tras.	2+5	4/137	12SS17							ALUG15BX
14x6 Del.	4+2	4/137								ALUG15BX
14x8 Tras.	3+5	4/137	14SS17							ALUG15BX
KAWASAKI Teryk 750										
12x7 Del.	5+2	4/137 12m/m				12SS308				ALUG16BX
12x7 Tras.	5+2	4/137 12m/m				12SS308				ALUG16BX
KAWASAKI Brute Force 750i										
12x7 Del.	5+2	4/110				12SS346				ALUG14BX
12x7 Tras.	5+2	4/110				12SS346				ALUG14BX
POLARIS Sportsman / Sportsman 400-450 / Sportsman 500 / Magnum 500 / Sportsman 600 / Sportsman 700 / Sportsman 800 / Ranger3 / RZR 800 / RZR 800 S / RZR 900 XP / RZR 1000 / Ranger 900 XP (Scrambler 850 / Sportsman 550 XP / Sportsman 850 XP Solo llanta 14")										
12x7 Del.	4+3	4/156				12SS303		12SS703		ALUG13BX
12x7 Tras.	4+3	4/156				12SS303		12SS703		ALUG13BX
14x6 Del.	4+2	4/156		14SS33				14SS703		ALUG13BX
14x8 Tras.	5+3	4/156		14SS35				14SS705		ALUG13BX
14x8 Tras.	3+5	4/156		14SS42						ALUG13BX
POLARIS ACE 570 / 900 (14-16)										
12x7 Del./Tras	4+3	4/156							12RB113	ALUG13BX

* ALUG20BX / ALUG21BX Juego de 16 tornillos, se entrega con herramienta especial. 34,92€



HURRICANE TSUNAMI



HURRICANE



TSUNAMI
TSUNAMI BEADLOCK

14x7"	122,00€	14x7"	136,05€	14x7"	195,74€
15x7"	136,00€	15x7"	140,74€	15x7"	232,63€

Dimensiones	Desplazamiento	Ataque	Hurricane	Tsunami	Tsunami Beadlock	Tornillos Cromados
ARCTIC CAT Prowler 06-17, Wildcat 12-17						
14x7	5+2	4/115	14RB119	14TS119BX	14TSB119BX	ALUG14BX
15x7	5+2	4/115	15RB119	15TS119BX	15TSB119BX	ALUG14BX
CAN AM Commander 800/1000 11-17, Maverick 13-17, Defender 16-17,						
14x7	5+2	4/137	14RB118	14TS118BX	14TSB118BX	ALUG14BX
15x7	5+2	4/137	15RB118	15TS118BX	15TSB118BX	ALUG14BX
CAN AM Maverick X3 2017						
14x7	5+2	4/137	14RB118	14TS118BX	14TSB118BX	ALUG20BX
15x7	5+2	4/137	15RB118	15TS118BX	15TSB118BX	ALUG20BX
POLARIS RZR 800 08-14, RZR 900 XP 10-14						
14x7	4+3	4/156	14RB113	14TS113BX	14TSB113BX	ALUG13BX
15x7	4+3	4/156	15RB113	15TS113BX	15TSB113BX	ALUG13BX
POLARIS General 15-17, Ranger 900 XP 13-17, Ranger 1000 13-17, RZR 900 15-17, RZR 1000 15-17						
14x7	4+3	4/156	14RB113	14TS113BX	14TSB113BX	ALUG20BX
15x7	4+3	4/156	15RB113	15TS113BX	15TSB113BX	ALUG20BX
YAMAHA YXZ 1000R 16-17, YXZ 1000R SS 2017						
14x7	5+2	4/110	14RB110	14TS110BX	14TSB110BX	ALUG19BX
15x7	5+2	4/110	15RB110	15TS110BX	15TSB110BX	ALUG19BX

XPEED X-5 / X-6



T-5 / T-7 / T-7C



X-6
72,90€



X-5
72,90€



T-5
83,90€



T-7 14"
83,90€



T-7C Cromado
83,90€

Dimensiones	Desplazamiento	Ataque	Xpeed Tipo X-6	Xpeed Tipo X-5	ITP Tipo 5	ITP Tipo 7	ITP Tipo 7C	Tapa bujes cromados	Tornillos Cromados
BOMBARDIER Traxter / Quest 650 // HONDA 300 4x4 / Rancher 350 S-ES / Rancher 400 -420 4x4 / Foreman 400 / Foreman 450-500 S-ES / Rubicon 500 // KYMCO MXU 500 // SUZUKI Eiger / King Quad 400 / Vinson // YAMAHA Grizzly 350 / Bruin 350 / Wolverine 350 / Big Bear 350 -400 / Kodiak 400-450 / Grizzly 600									
12x7 Del.	5+2	4/110		W22110	12D110			P110BX	W00011BX
12x7 Tras.	2+5	4/110			12D111*		12D511*	P110BX	W00011BX
12x7,5 Tras.	2,5+5	4/110		W22111*					W00011BX
14x7 Del.	5+2	4/110				14D110		P110BX	W00011BX
14x7 Tras.	2+5	4/110				14D111		P110BX	W00011BX
HONDA Rincon 650 - 680 // KAWASAKI Brute Force 650i / Brute Force 750 // SUZUKI King Quad 450 - 700 - 750 // YAMAHA Kodiak 400 -450 / Grizzly 400 - 450 - 660 / Rhino 450 - 660 * Si se requiere una mayor anchura (entre 5 y 7 cm por llanta) superior en el eje trasero sobre el delantero, montar las llantas trasera del apartado superior marcadas con asterisco (*)									
12x7 Del.	5+2	4/110	W12110	W22110					W00011BX
12x7 Tras.	5+2	4/110	W12110	W22110					W00011BX

Interpretación de las medidas

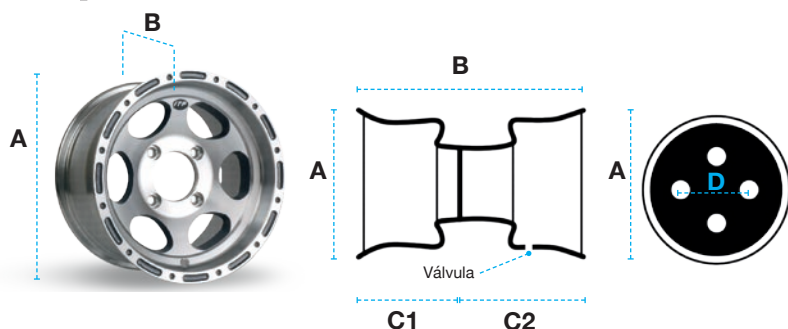

DIMENSIONES
A x B
(12x7)

DESPLAZAMIENTO
C1 + C2
(5+2)

ATAQUE
Nº de agujeros / D
(4 / 110)

Llanta

Dimensiones	Desplazamiento	Ataque	Referencia
12x7	5+2	4/110	12D210
Dimensión en pulgadas	En pulgadas	En pulgadas	Referencia del producto

Neumáticos

Descripción	Referencia	PR	Límite de carga (Kg)	Peso (Kg)
● 21x7-10	A8003A1	4	93	4,55
Dimensión en pulgadas	Referencia del producto	Índice de lonas	Máximo peso que soporta el neumático (recomendable)	Peso aprox. del neumático



DIMENSIONES (Descripción)
A x B - C
(21 x 7 - 10)

Descripción	Referencia	Índice	Peso (Kg)
● 175 / 70-10	A8022A1	42N	4,55
Dimensiones milimétricas	Referencia del producto	42 Índice de carga	Peso aprox. del neumático
Llanta en pulgadas		N Índice de velocidad	



DIMENSIONES (Descripción)
A x B - C
(175/70 R10)

● Indica neumático homologado

Índice de carga

Índice	Kg	Índice	Kg	Índice	Kg	Índice	Kg
20	80	35	121	50	190	65	290
21	82	36	125	51	195	66	300
22	85	37	128	52	200	67	307
23	87	38	132	53	206	68	315
24	90	39	136	54	212	69	325
25	92	40	140	55	218	70	335
26	95	41	145	56	224	71	345
27	97	42	150	57	230	72	355
28	100	43	155	58	236	73	365
29	103	44	160	59	243	74	375
30	106	45	165	60	250	75	387
31	109	46	170	61	257	76	400
32	112	47	175	62	265	77	412
33	115	48	180	63	272	78	425
34	118	49	185	64	280	79	437

Índice Velocidad

Índice	Km / h	Índice	Km / h
A1	5	K	110
A2	10	L	120
A3	15	M	130
A4	20	N	140
A5	25	P	150
A6	30	Q	160
A7	35	R	170
A8	40	S	180
B	50	T	190
C	60	U	200
D	65	H	210
E	70	V	240
F	80	W	270
G	90	Y	300
J	100		

Cantidades



< 75 Km/h

$\emptyset(\text{cm}) \times \text{An} (\text{cm}) \times 0,55 = \text{ml}$

> 75 Km/h

$\emptyset(\text{cm}) \times \text{An} (\text{cm}) \times 0,3 = \text{ml}$



Ejemplo:

Speed Gear Quad

21x7-10

53Ø x 18An x 0,3= 315 ml slime



Sellador

Referencia	Descripción	€
DUP12216	250 ml	4,65
DUP122162	473 ml	8,32



Probado en pinchazos a gran velocidad



Mini compresor de viaje

El kit Slime incluye:

- Un compresor con manómetro y conexiones.
- Mazo de cableado principal con fusible.
- Manguito aire.
- Pinzas de batería.
- Precableado directo a batería.

XPEED 3 Cargas CO2 16gr.

Referencia	Peso (kg)	Dimensiones (cm)	€
S40006	0,95	15X16X6	42,12



Referencia	€
X30501	8,00

BRONCO Kit repara pinchazos con bolsa



4 Tapones aluminio

Referencia	€
DAT12208	26,72
DAT12200	26,72



PLATA

AZUL

Referencia	€	Referencia	€
S1020	5,80	S1018	5,80



Kit repara pinchazos y recambios tiras



Kit profesional

Referencia	Descripción	€
DUP12307A	Recambio 10 mechas	4,13
S21032	Kit repara pinchazos	7,20



Referencia	€
S2510	20,71

RUEDAS Y NEUMÁTICOS

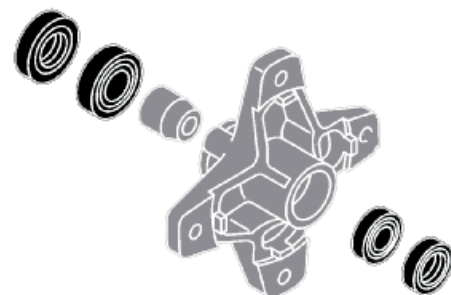
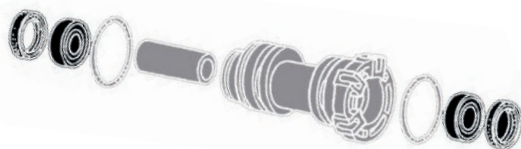

BRONCO Kit cojinetes ruedas o eje trasero

El kit consta de todas las piezas para reparar un buje a excepción del **DAT06612** que es para dos bujes. Los vehículos con eje rígido trasero, el kit incluye el material para todo el buje.

ARCTIC CAT	KIT DELANTERO			KIT TRASERO	
	Año	Referencia	€	Referencia	€
400 DVX	04-08	DAT06636	21,90	DAT06620	23,18
todos	96-04	DAT06623	29,11	DAT06623	29,11
todos	05-14	DAT06624	28,52	DAT06624	28,52

CAN AM	KIT DELANTERO			KIT TRASERO	
	Año	Referencia	€	Referencia	€
400 Outlander	06-14	DAT06631	27,05	DAT06631	27,05
450 DS	08-14	DAT06631	27,05		
500 Traxter	99-01	DAT06628	27,93		
500 Outlander	07-14	DAT06631	27,05	DAT06631	27,05
500 Renegade	08-14	DAT06631	27,05	DAT06631	27,05
650 Outlander	07-14	DAT06631	27,05	DAT06631	27,05
800 Commander	11-15	DAT06631	27,05	DAT06631	27,05
800 Outlander	06-14	DAT06631	27,05	DAT06631	27,05
800 Renegade	07-14	DAT06631	27,05	DAT06631	27,05
1000 Commander	11-15	DAT06631	27,05	DAT06631	27,05
1000 Maverick	14-15	DAT06631	27,05	DAT06631	27,05
1000 Outlander	12-14	DAT06631	27,05	DAT06631	27,05
1000 Renegade	12-14	DAT06631	27,05	DAT06631	27,05

GAS GAS	KIT DELANTERO			KIT TRASERO	
	Año	Referencia	€	Referencia	€
Wild 300 HP	03-06	DAT06654	16,61		
Wild 450 HP	03-08	DAT06654	16,61		

HONDA	KIT DELANTERO			KIT TRASERO	
	Año	Referencia	€	Referencia	€
TRX 250 Sportrax	01-14	DAT06642	16,61	DAT06640	36,75
TRX 250 Recon	97-14	DAT06629	16,86	DAT06640	36,75
TRX 300 Sportrax	93-09	DAT06654	16,61	DAT06617	23,08
TRX 300 Fourtrax 2x4	88-00			DAT06611	19,22
TRX 300 Fourtrax 4x4	88-00	DAT06600	29,40	DAT06611	19,22
TRX 350 Rancher FM/FE	00-06	DAT06630	29,55	DAT06609	35,13
TRX 350 Rancher TE/TM	00-06	DAT06629	16,86	DAT06609	35,13
TRX 400 Sportrax	99-01	DAT06654	16,61	DAT06617	23,08
TRX 400 Sportrax	02-14	DAT06642	16,61	DAT06617	23,08
TRX 400 Foreman	95-03	DAT06602	29,40	DAT06609	35,13
TRX 400 Rancher	04-07	DAT06630	29,55	DAT06609	35,13
TRX 420 Rancher	07-14	DAT06600	29,40	DAT06656	28,22
TRX 450 R	04-14	DAT06642	16,61	DAT06647	27,64
TRX 450 Fourtrax	98-04	DAT06602	29,40	DAT06609	35,13
TRX 500 Rubicon	01-04	DAT06602	29,40	DAT06609	35,13
TRX 500 Rubicon	05-15	DAT06637	29,84	DAT06609	35,13
TRX 650 Rincon	03-05	DAT06602	29,40	DAT06660	26,31
TRX 680 Rincon	06-15	DAT06637	29,84	DAT06660	26,31
TRX 700 XX	08-09			DAT06656	28,22

KAWASAKI	KIT DELANTERO			KIT TRASERO	
	Año	Referencia	€	Referencia	€
KSF 250 Mojave	88-04			DAT06644	22,79
KEF 300 Lakota	95-03			DAT06644	22,79
KVF 300 Brute Force	12-14	DAT06654	16,61		
KVF 300 A Prairie	99-02	DAT06627	28,52		
KVF 300 B Prairie	99-02	DAT06627	28,52		
KLF 300 B Bayou	88-04			DAT06633	21,02
KLF 300 C Bayou	88-04	DAT06627	28,52		
KVF 360 Prairie	03-13	DAT06627	28,52		
KFX 400	03-06	DAT06636	21,90	DAT06620	23,18
KLF 400 Bayou	93-99	DAT06627	28,52		
KVF 400 Prairie	97-02	DAT06627	28,52		
KFX 450 R	08-14	DAT06654	16,61	DAT06652	27,93

KVF 650 Prairie	02-03	DAT06627	28,52		
KVF 650 Brute Force	05-13	DAT06627	28,52		
KVF 650 i Brute Force	06-09			DAT06633	21,02
KFX 700 V-Force	04-09	DAT06654	16,61		
KVF 700 Prairie	04-06	DAT06627	28,52		
KVF 750i Brute Force	05-15			DAT06633	21,02
TERYX 750	2008			DAT06633	21,02

KTM	KIT DELANTERO			KIT TRASERO	
	Año	Referencia	€	Referencia	€
450 SX	09-10			DAT06649	43,94
450 XC	08-09			DAT06649	43,94
505 SX	09-10			DAT06649	43,94
525 XC	08-09			DAT06649	43,94

KYMCO	KIT DELANTERO			KIT TRASERO	
	Año	Referencia	€	Referencia	€
KXR 250		DAT06654	16,61		
Maxxer 250		DAT06654	16,61		
MXU 250	04-05	DAT06654	16,61		
Maxxer 300		DAT06654	16,61		
MXU 300	05-08	DAT06654	16,61		
MXU 400		DAT06624	28,52	DAT06624	28,52
MXU 500		DAT06624	28,52	DAT06624	28,52

POLARIS	KIT DELANTERO			KIT TRASERO	
	Año	Referencia	€	Referencia	€
200 Phoenix	2005	DAT06626	16,70		
250 Trail Boss	88-99	DAT06643	27,78	DAT06618	21,37
250 Trail Blazer	90-98	DAT06643	27,78	DAT06618	21,37
250 Trail Blazer	99-04	DAT06643	27,78	DAT06613	27,20
250 Trail Blazer	05-06	DAT06626	16,70	DAT06613	27,20
250 Xplorer 4X4	00-02	DAT06604	26,15	DAT06613	27,20
300 Hawkeye	06-11	DAT06622	26,31	DAT06622	26,31
300 Sportsman 4X4	08-10	DAT06622	26,31	DAT06622	26,31
325 Magnum 2x4	00-01	DAT06643	27,78		
325 Magnum 2x4	2002	DAT06643	27,78	DAT06622	26,31
325 Magnum 4x4	00-01	DAT06604	26,15		
325 Magnum 4x4	2002	DAT06604	26,15	DAT06622	26,31
325 Magnum 4x4 HDS	01-02	DAT06622	26,31	DAT06622	26,31
325 Trail Boss	00-02	DAT06643	27,78	DAT06613	27,20
330 Magnum 2x4	03-05	DAT06643	27,78	DAT06622	26,31
330 Magnum 4x4	03-05	DAT06622	26,31	DAT06622	26,31
330 Trail Blazer	08-09	DAT06626	16,70	DAT06613	27,20
330 Trail Blazer	10-13	DAT06622	26,31	DAT06613	27,20
330 Trail Boss	03-04	DAT06643	27,78	DAT06613	27,20
330 Trail Boss	05-09	DAT06626	16,70	DAT06613	27,20
330 Trail Boss	10-13	DAT06622	26,31	DAT06613	27,20
335 Sportsman	99-00	DAT06604	26,15	DAT06612	55,13
400 Hawkeye	12-14	DAT06622	26,31	DAT06612	55,13
400 Scrambler 2x4	01-02	DAT06643	27,78	DAT06613	27,20
400 Scrambler 4x4	95-97	DAT06604	26,15	DAT06618	21,37
400 Scrambler 4x4	98-02	DAT06604	26,15	DAT06613	27,20
400 Sport	94-98	DAT06643	27,78	DAT06618	21,37
400 Sport	1999	DAT06643	27,78	DAT06613	27,20
400 Sportsman	94-97	DAT06604	26,15	DAT06618	21,37
400 Sportsman	01-04	DAT06604	26,15	DAT06612	55,13
400 Sportsman	05-06	DAT06622	26,31	DAT06612	55,13
400 Sportsman HO	08-10	DAT06622	26,31	DAT06622	26,31
400 Sportsman HO	11-14	DAT06622	26,31	DAT06612	55,13
400 Trail Blazer	2003	DAT06643	27,78	DAT06613	27,20
425 Xpedition	00-01	DAT06604	26,15		
425 Xpedition	2002	DAT06604	26,15	DAT06622	26,31



DAT06657



DAT06651

BRONCO Kit cojinetes ruedas o eje trasero

450 Outlaw	08-10	DAT06626	16,70	DAT06648	47,11
450 Sportsman	06-07	DAT06622	26,31	DAT06612	55,13
500 ATP 4X4	04-05	DAT06622	26,31	DAT06622	26,31
500 Magnum 4X4	99-01	DAT06604	26,15		
500 Magnum 4X4 HDS	01-03	DAT06622	26,31	DAT06622	26,31
500 Magnum 2X4 HDS	2002	DAT06643	27,78	DAT06622	26,31
500 Magnum 4X4	2002	DAT06622	26,31	DAT06622	26,31
500 Outlaw	06-07	DAT06626	16,70	DAT06622	26,31
500 Predator	2003	DAT06626	16,70	DAT06649	43,94
500 Predator	04-07	DAT06626	16,70	DAT06648	47,11
500 Ranger 2x4	08-09	DAT06622	26,31	DAT06612	55,13
500 Ranger 4x4	05-08	DAT06622	26,31	DAT06612	55,13
500 Ranger	09-10	DAT06657	32,05	DAT06612	55,13
500 Ranger	11-13	DAT06622	26,31	DAT06612	55,13
500 Scrambler 2x4	00-02	DAT06643	27,78	DAT06613	27,20
500 Scrambler 2x4	2008	DAT06626	16,70	DAT06613	27,20
500 Scrambler 4x4	1997	DAT06604	26,15	DAT06618	21,37
500 Scrambler 4x4	98-09	DAT06604	26,15	DAT06613	27,20
500 Scrambler 4x4	10-12	DAT06622	26,31	DAT06613	27,20
500 Sportsman 4x4	96-03	DAT06604	26,15	DAT06612	55,13
500 Sportsman 4x4	04-14	DAT06622	26,31	DAT06612	55,13
525 Outlaw IRS	07-11	DAT06626	16,70	DAT06622	26,31
525 Outlaw S	08-10	DAT06626	16,70	DAT06648	47,11
550 Sportsman	09-14	DAT06657	32,05	DAT06657	32,05
600 Sportsman	03-05	DAT06622	26,31	DAT06612	55,13
700 Sportsman	02-08	DAT06622	26,31	DAT06612	55,13
700 Ranger	05-08	DAT06622	26,31	DAT06612	55,13
700 Ranger	2009	DAT06657	32,05	DAT06612	55,13
800 Sportsman	05-12	DAT06622	26,31	DAT06612	55,13
800 Ranger	10-14	DAT06657	32,05	DAT06612	55,13
800 RZR	08-09	DAT06659	26,31	DAT06612	55,13
800 RZR	11-14	DAT06657	32,05	DAT06612	55,13
800 RZR "S"	2009	DAT06659	26,31	DAT06612	55,13
800 RZR "S"	10-14	DAT06657	32,05	DAT06612	55,13
800 RZR 4	2011	DAT06657	32,05	DAT06612	55,13
850 Sportsman	09-14	DAT06657	32,05	DAT06657	32,05
900 Ranger	11-14	DAT06657	32,05	DAT06612	55,13
900 RZR XP	11-14	DAT06657	32,05	DAT06657	32,05
900 RZR XP "4"	13-14	DAT06657	32,05	DAT06657	32,05

KIT DELANTERO KIT TRASERO

SUZUKI	Año	Referencia	€	Referencia	€
LT-F 250 Quadrunner	99-01	DAT06610	20,14	DAT06614	28,67
LT-Z 250 Quadspport	05-09	DAT06636	21,90		
LT-F 300 King Quad	91-02	DAT06610	20,14	DAT06614	28,67
LT-A 400 Eiger	02-07	DAT06610	20,14	DAT06672	16,76
LT-F 400 Eiger	02-07	DAT06610	20,14	DAT06672	16,76
LT-A 400 King Quad	08-14	DAT06610	20,14	DAT06672	16,76
LT-F 400 King Quad	08-14	DAT06610	20,14	DAT06672	16,76
LT-Z 400 Quadspport	03-08	DAT06636	21,90	DAT06620	23,18
LT-Z 400 Quadspport	2009	DAT06636	21,90	DAT06647	27,64
LT-R 450	06-11	DAT06636	21,90	DAT06651	33,52
LT-A 450 King Quad	07-10	DAT06666	31,75	DAT06667	34,69
LT-F 500 Quad Runner	98-01	DAT06610	20,14	DAT06672	16,76
LT-A 500 Quad Master	00-01	DAT06610	20,14	DAT06672	16,76
LT-A 500 Vinson	02-07	DAT06610	20,14	DAT06672	16,76
LT-F 500 Vinson	03-07	DAT06610	20,14	DAT06672	16,76
LT-A 500	09-14	DAT06666	31,75	DAT06667	34,69
LT-V 700 Twin Peaks	04-06	DAT06627	28,52		
LT-A 700 King Quad	05-07	DAT06666	31,75	DAT06667	34,69
LT-A 750i King Quad	08-14	DAT06666	31,75	DAT06667	34,69

	KIT DELANTERO		KIT TRASERO		
YAMAHA	Año	Referencia	€	Referencia	€
YFM 50 Raptor	04-08	DAT06677	22,26		
YFM 80 Badger	92-01	DAT06677	22,26		
YFM 80 Raptor	02-08	DAT06677	22,26		
YFA 125 Breeze	91-04	DAT06677	22,26		
YFM 125 Grizzly	04-13	DAT06677	22,26		
YFM 125 Raptor	11-13	DAT06635	23,52	DAT06650	22,34
YFS 200 Blaster	88-02	DAT06655	26,02	DAT06615	21,76
YFS 200 Blaster	03-06	DAT06635	23,52	DAT06615	21,76
YFM 250 Raptor	08-13	DAT06635	23,52	DAT06650	22,34
YFB 250 Timberwolf	95-98	DAT06635	23,52		
YFM 250 Beartracker	99-00			DAT06607	34,99
YFM 250 Beartracker	01-04	DAT06635	23,52	DAT06668	34,40
YFM 250 Bruin	05-06	DAT06635	23,52	DAT06668	34,40
YFM 250 Big Bear	07-09	DAT06635	23,52	DAT06668	34,40
YFM 300 Grizzly	12-13				
YFZ 350 Banshee	87-06	DAT06635	23,52	DAT06615	21,76
YFM 350 Warrior	87-04	DAT06635	23,52	DAT06619	23,18
YFM 350 Raptor	04-13	DAT06635	23,52	DAT06650	22,34
YFM 350 Big Bear	87-95	DAT06610	20,14		
YFM 350 Big Bear	96-99	DAT06610	20,14	DAT06607	34,99
YFM 350 Bruin	04-06	DAT06610	20,14	DAT06668	34,40
YFM 350 Grizzly	07-14	DAT06610	20,14	DAT06668	34,40
YFM 350 Grizzly IRS	07-11	DAT06610	20,14	DAT06624	28,52
YFM 350 Wolverine	95-99	DAT06610	20,14	DAT06669	27,78
YFM 350 Wolverine	06-09	DAT06610	20,14	DAT06668	34,40
YFM 400 Big Bear Pro	00-06	DAT06610	20,14	DAT06668	34,40
YFM 400 Grizzly auto. IRS	07-08	DAT06610	20,14	DAT06624	28,52
YFM 400 Kodiak semi.	93-99	DAT06610	20,14	DAT06608	36,75
YFM 400 Kodiak auto.	00-02	DAT06610	20,14	DAT06606	31,16
YFM 400 Kodiak auto.	03-04	DAT06610	20,14	DAT06668	34,40
YFM 400 Kodiak auto. IRS	05-06	DAT06610	20,14	DAT06624	28,52
YFZ 450	04-05	DAT06635	23,52	DAT06645	35,87
YFZ 450	06-09	DAT06635	23,52	DAT06639	57,48
YFZ 450	12-14	DAT06635	23,52	DAT06658	51,13
YFZ 450 R	09-14	DAT06635	23,52	DAT06658	51,13
YFM 450 Grizzly IRS	07-14	DAT06610	20,14	DAT06624	28,52
YFM 450 Kodiak	03-04	DAT06610	20,14	DAT06606	31,16
YFM 450 Kodiak IRS	05-06	DAT06610	20,14	DAT06624	28,52
YFM 450 Wolverine	06-10	DAT06610	20,14		
YXR 450 Rhino	06-09	DAT06610	20,14	DAT06632	21,32
YFM 550 Grizzly	09-14	DAT06624	28,52	DAT06624	28,52
YFM 600 Grizzly	98-01	DAT06610	20,14	DAT06607	34,99
YFM 660 Raptor	01-05	DAT06635	23,52	DAT06615	21,76
YFM 660 Grizzly	2002	DAT06621	19,85	DAT06625	29,40
YFM 660 Grizzly	03-08	DAT06624	28,52	DAT06624	28,52
YXR 660 Rhino	04-07	DAT06610	20,14	DAT06632	21,32
YFM 700 Raptor	06-12	DAT06635	23,52	DAT06639	57,48
YFM 700 Raptor	13-15	DAT06635	23,52		
YFM 700 Grizzly	07-15	DAT06624	28,52	DAT06624	28,52
YXR 700 Rhino FI	08-14	DAT06610	20,14	DAT06632	21,32
YXZ 1000 R	16-17			DAT06676	52,18

RUEDAS Y NEUMÁTICOS

MOTOR

ADMISIÓN / ESCAPE
REFRIGERACIÓN

ELECTRICO

SUSPENSIÓN / DIRECCIÓN

FRENOS

TRANSMISIÓN

CONTROLES Y MANDOS

CHASIS

ACCESORIOS

XPEED Separadores aluminio

€
56,86



Separadores de aluminio 1,60kg. y ancho de 45 mm.
Se sirve para dos ruedas, incluye 8 alargadores.

Fáciles de montar y desmontar.

ARCTIC CAT	DELANTERO		TRASERO		
	Año	Ataque	Referencia	Ataque	Referencia
250	99-03	4/115	P5228	4/115	P5228
300	98-03	4/115	P5228	4/115	P5228
375	2002	4/115	P5228	4/115	P5228
400	98-05	4/115	P5228	4/115	P5228
DVD 400	04-08	4/144	P5231	4/110	P5228
454	96-98	4/115	P5228	4/115	P5228
500 Todos	98-01	4/115	P5228	4/115	P5228
650i	04-06	4/115	P5228	4/115	P5228
Wild Cat 1000	12-16	4/115	P5228	4/115	P5228

CAN AM	DELANTERO		TRASERO		
	Año	Ataque	Referencia	Ataque	Referencia
Outlander 330	03-09	4/137	P5231	4/137	P5231
Outlander 400	03-11	4/137	P5231	4/137	P5231
DS 450	08-11	4/144	P5233	4/110	P5230
Traxter 500	99-05	4/110	P5228	4/110	P5228
Quest 500	00-05	4/110	P5228	4/110	P5228
DS 650	Todos	4/144	P5233	4/144	P5233
Quest 650	00-05	4/110	P5228	4/110	P5228
Outlander 650	2006	4/137	P5231	4/137	P5231
Outlander 800	2006	4/137	P5231	4/137	P5231
Commander 800	Todos	4/137	P5242	4/137	P5242
Commander 1000	Todos	4/137	P5242	4/137	P5242
Maverick 1000	Todos	4/137	P5242	4/137	P5242

GAS GAS	DELANTERO		TRASERO		
	Año	Ataque	Referencia	Ataque	Referencia
Todos los modelos	03-10	4/144	P5231	4/110	P5228

HONDA	DELANTERO		TRASERO		
	Año	Ataque	Referencia	Ataque	Referencia
TRX 200	90-97	4/110	P5228	4/110	P5228
TRX 250 D & ES Recon	97-06	4/110	P5228	4/110	P5228
TRX 250 EX	00-10	4/144	P5231	4/110	P5228
TRX 300	88-00	4/110	P5228	4/110	P5228
TRX 300 EX	93-10	4/144	P5231	4/110	P5228
Rancher 350 ES	00-04	4/110	P5228	4/110	P5228
Rancher AT 400	2004	4/110	P5228	4/110	P5228
TRX 400 D Foreman	96-06	4/110	P5228	4/110	P5228
TRX 400 EX	99-10	4/144	P5231	4/110	P5228
TRX 450 S & ES Foreman	98-05	4/110	P5228	4/110	P5228
TRX 450 R	04-10	4/144	P5231	4/110	P5228
TRX 500 Foreman	98-11	4/110	P5228	4/110	P5228
TRX 650 Rincon	03-06	4/110	P5228	4/110	P5228

KAWASAKI	DELANTERO		TRASERO		
	Año	Ataque	Referencia	Ataque	Referencia
TRX 680 Rincon	06-12	4/110	P5228	4/110	P5228

KLF 220 Bayou	88-02	4/137	P5231	4/110	P5228
KSF 250 Mojave	87-06	4/156	P5231	4/156	P5231
KLF 300 2X4 Bayou	85-05	4/137	P5231	4/137	P5231
KLF 300 4X4 Bayou	89-05	4/137	P5231	4/137	P5231
KLF 300 B Lakota	95-00	4/156	P5231	4/156	P5231
KVF 300 Prairie	99-05	4/137	P5231	4/137	P5231
Prairie 350	03-10	4/137	P5231	4/137	P5231
KFX 400	03-09	4/144	P5231	4/110	P5228
KLF 400 Bayou	93-05	4/137	P5231	4/137	P5231
Prairie 400	97-05	4/137	P5231	4/137	P5231
KFX 450	08-10	4/144	P5231	4/110	P5228
KVF 650 Prairie	03-06	4/137	P5231	4/137	P5231
Brute Force 650i	2006	4/110	P5228	4/110	P5228
Brute Force 650	05-10	4/137	P5231	4/137	P5231
KFX 700 V-Force	03-06	4/144	P5231	4/137	P5231
KVF 700 Prairie	03-06	4/137	P5231	4/137	P5231
Brute Force 750	05-12	4/110	P5228	4/110	P5228
Mule 500/600	Todos	4/137	P5231	4/137	P5231

KTM	DELANTERO		TRASERO		
	Año	Ataque	Referencia	Ataque	Referencia
450 XC	08-10	4/156	P5231	4/110	P5228
525 XC	08-10	4/156	P5231	4/110	P5228

POLARIS	DELANTERO		TRASERO		
	Año	Ataque	Referencia	Ataque	Referencia
Xplorer 250	00-02	4/156	P5232		
Trail Blazer 250	86-11	4/156	P5232	4/110	P5234
Trail Boss 250	86-11	4/156	P5232	4/110	P5234
Trail Boss 2X4 250	87-99	4/156	P5232	4/110	P5234
Xpress 300	96-99	4/156	P5232		
Xplorer 300	90-99	4/156	P5232		
Magnum 300L	96-99	4/156	P5232		
Magnum 325	02-06	4/156	P5232	4/156	P5232
Trail Boss 325	00-02	4/156	P5232		
Trail Boss 330	2003	4/156	P5232	4/110	P5234
Trail Boss 350L	90-99	4/156	P5232	4/156	P5232
Trail Boss 350	90-99	4/156	P5232		
Trail Boss 400L	90-99	4/156	P5232		
Xpedition 325	00-06	4/156	P5232		
Sportsman 335	99-06	4/156	P5232	4/156	P5232
Magnum 400L 2 WD	96-99	4/156	P5232		
Scrambler 400L	95-08	4/156	P5232	4/100	P5234
Sport 400L	94-99	4/156	P5232		
Sportsman 400L	01-06	4/156	P5232	4/156	P5232
Sportsman 400	95-98	4/156	P5232		
Xplorer 400L	95-03	4/156	P5232		
Xpedition 425	99-06	4/156	P5232		

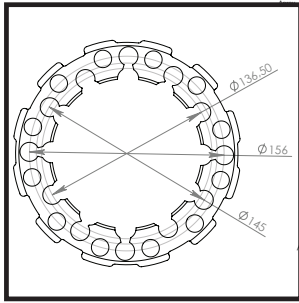

P5231
P5232
P5233

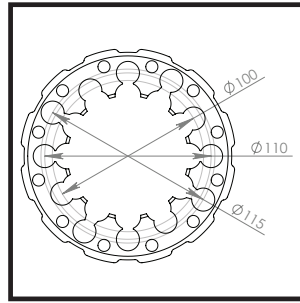

P5228
P5229
P5230

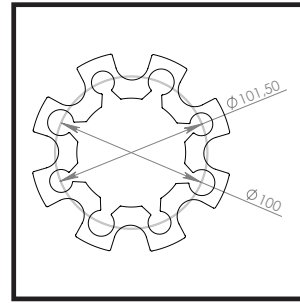

P5234
P5243

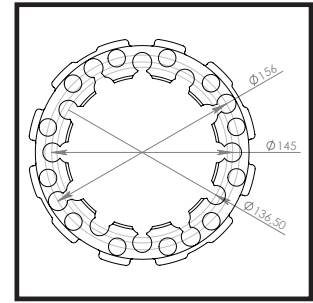

P5242

Modelo	Año	Ataque	Referencia	Ataque	Referencia
Diesel 455	99-06	4/156	P5232		
Xplorer 500	96-06	4/156	P5232	4/156	P5232
Magnum 500	02-05	4/156	P5232	4/156	P5232
Outlaw 500	Todos	4/156	P5232	4/110	P5229
Predator 500	2003	4/156	P5232	4/156	P5232
Predator 500	04-07	4/156	P5232	4/110	P5229
Scrambler 500L	97-11	4/156	P5232	4/100	P5234
Sportsman 500	96-06	4/156	P5232	4/156	P5232
Sportsman 600	03-06	4/156	P5232	4/156	P5232
Sportsman 700	02-06	4/156	P5232	4/156	P5232
Sportsman 800	04-06	4/156	P5232	4/156	P5232
Ranger Todos	Todos	4/156	P5232	4/156	P5232
RZR	08-16	4/156	P5232	4/156	P5232

DELANTERO | **TRASERO**

SUZUKI					
Año	Ataque	Referencia	Ataque	Referencia	
LTX 250 Ozark	02-05	4/144	P5231	4/110	P5228
Eiger 400	02-07	4/110	P5228	4/110	P5228
LTX 400	03-11	4/144	P5231	4/110	P5228
LTR 450	06-11	4/144	P5231	4/110	P5228
Vinson 500	02-06	4/110	P5228	4/110	P5228
Twin Peaks 700	04-06	4/137	P5231	4/137	P5231
King Quad 700	05-07	4/110	P5228	4/110	P5228
King Quad 750	08-13	4/110	P5228	4/110	P5228

DELANTERO | **TRASERO**

YAMAHA					
Año	Ataque	Referencia	Ataque	Referencia	
YFS 200 Blaster	88-07	4/156	P5231	4/100	P5243
YFM 250 Raptor	08-11	4/156	P5231	4/115	P5228
YFB 250 Bear Tracker	99-05	4/110	P5228	4/110	P5228
YFM 250 Bruin	05-06	4/110	P5228	4/110	P5228
YFZ 350 Banshee	91-06	4/156	P5231	4/115	P5228
YFM 350 Bruin	04-06	4/110	P5228	4/110	P5228
YFM 350 Warrior	87-04	4/156	P5231	4/115	P5228
YFM 350 Raptor	04-11	4/156	P5231	4/115	P5228
YFM 350 Wolverine	95-06	4/110	P5228	4/110	P5228
YFM 350 Big Bear	87-06	4/110	P5228	4/110	P5228
YFM 400 Big Bear	87-06	4/110	P5228	4/110	P5228
YFM 400 Kodiak	93-96	4/110	P5228	4/110	P5228
YFM 450 Kodiak	93-96	4/110	P5228	4/110	P5228
YFM 450 Wolverine	06-08	4/110	P5228	4/110	P5228
YFZ 450	04-13	4/156	P5231	4/115	P5228
YFZ 450 R	09-16	4/156	P5231	4/115	P5228
YXR 450 Rhino	06-09	4/110	P5228	4/110	P5228
YFM 600 Grizzly	98-01	4/110	P5228	4/110	P5228
YFM 660 Grizzly	02-08	4/110	P5228	4/110	P5228
YFM 660 Raptor	01-05	4/156	P5231	4/115	P5228
YXR 700 Rhino	04-07	4/110	P5228	4/110	P5228
YFM 700 Grizzly	07-17	4/110	P5228	4/110	P5228
YFM 700 Kodiak	16-17	4/110	P5228	4/110	P5228
YFM 700 Raptor	06-17	4/156	P5231	4/115	P5228
YXE 700 Wolverine	16-17	4/110	P5228	4/110	P5228
YXM 700 Viking	14-17	4/110	P5228	4/110	P5228
YXR 700 Rhino	08-13	4/110	P5228	4/110	P5228

Kit 2 tornillos de recambio

Referencia Kit	Para montar en los separadores de referencia
P5315	P5228
P5316	P5229
P5317	P5230
P5315	P5231
P5316	P5232
P5317	P5233
P5321	P5234
P5315	P5242
P5315	P5243

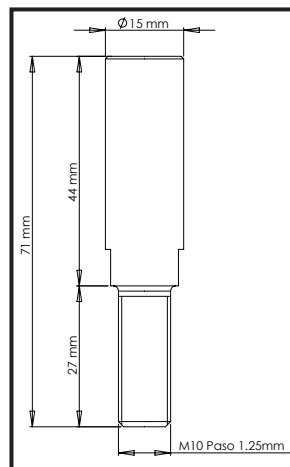

P5315

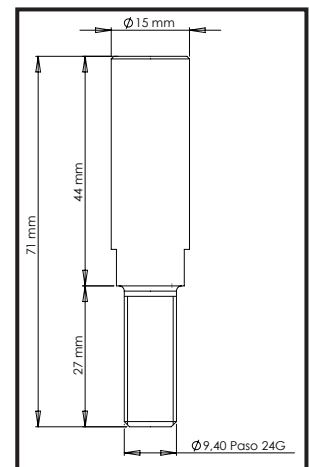

P5316

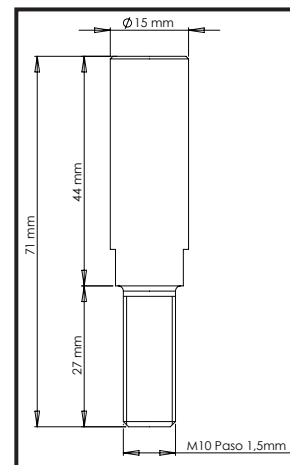

P5317

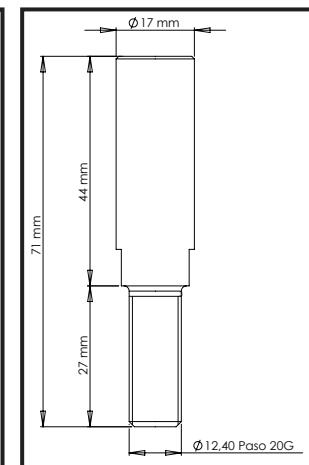

P5321

HONDA	Año	DELANTERO		TRASERO		
		Ataque	Referencia 45 mm	Ataque	Referencia 45 mm	Referencia 65 mm
TRX 250 Recon	97-06	4/110	Q045110	4/110	Q045110	Q065110
TRX 250 EX Sportrax	00-10	4/144		4/110	Q045110	Q065110
TRX 300 EX Sportrax	93-10	4/144		4/110	Q045110	Q065110
TRX 350 Rancher	00-04	4/110	Q045110	4/110	Q045110	Q065110
TRX 400 Rancher	2004	4/110	Q045110	4/110	Q045110	Q065110
TRX 400 Foreman	96-06	4/110	Q045110	4/110	Q045110	Q065110
TRX 400 EX Sportrax	99-10	4/144		4/110	Q045110	Q065110
TRX 450 Foreman	98-05	4/110	Q045110	4/110	Q045110	Q065110
TRX 450 R	04-10	4/144		4/110	Q045110	Q065110
TRX 500 Foreman	98-11	4/110	Q045110	4/110	Q045110	Q065110
TRX 650 Rincon	03-06	4/110	Q045110	4/110	Q045110	Q065110
TRX 680 Rincon	06-12	4/110	Q045110	4/110	Q045110	Q065110

KAWASAKI	Año	DELANTERO		TRASERO		
		Ataque	Referencia 45 mm	Ataque	Referencia 45 mm	Referencia 65 mm
KFX 400	03-06			4/110	Q045110	Q065110
KFX 450	08-10			4/110	Q045110	Q065110
KVF 650i Brute Force	2006	4/110	Q045110	4/110	Q045110	Q065110
KVF 750 Brute Force	05-12	4/110	Q045110	4/110	Q045110	Q065110

KTM	Año	DELANTERO		TRASERO		
		Ataque	Referencia 45 mm	Ataque	Referencia 45 mm	Referencia 65 mm
450 XC	08-10			4/110	Q045110	Q065110
525 XC	08-10			4/110	Q045110	Q065110

POLARIS	Año	DELANTERO		TRASERO		
		Ataque	Referencia 45 mm	Ataque	Referencia 45 mm	Referencia 65 mm
Trail Blazer 250	86-11			4/110		Q965100
Trail Boss 250	86-11			4/110		Q965100
Trail Boss 330	2003			4/110		Q965100
Scrambler 400L	95-08			4/100		Q965100
Outlaw 500	Todos			4/110	Q945110	
Predator 500	04-07			4/110	Q945110	
Scrambler 500L	97-11			4/100		Q965100

SUZUKI	Año	DELANTERO		TRASERO		
		Ataque	Referencia 45 mm	Ataque	Referencia 45 mm	Referencia 65 mm
LT-Z 250	02-05			4/110	Q045110	Q065110
LT-A 400 Eiger	02-07	4/110	Q045110	4/110	Q045110	Q065110
LTZ 400	03-11			4/110	Q045110	Q065110
LTR 450	06-11			4/110	Q045110	Q065110
LT-A 500 Vinson	02-07	4/110	Q045110	4/110	Q045110	Q065110
LT-A 700 King Quad	05-07	4/110	Q045110	4/110	Q045110	Q065110
LT-A 750 King Quad	08-13	4/110	Q045110	4/110	Q045110	Q065110

YAMAHA	Año	DELANTERO		TRASERO		
		Ataque	Referencia 45 mm	Ataque	Referencia 45 mm	Referencia 65 mm
YFM 250 Raptor	08-11			4/115	Q045115	Q065115
YFB 250 Bear Tracker	99-05	4/110	Q045110	4/110	Q045110	Q065110
YFM 250 Bruin	05-06	4/110	Q045110	4/110	Q045110	Q065110
YFM 350 Big Bear	87-06	4/110	Q045110	4/110	Q045110	Q065110
YFM 350 Bruin	04-06	4/110	Q045110	4/110	Q045110	Q065110
YFM 350 Grizzly	07-15	4/110	Q045110	4/110	Q045110	Q065110
YFM 350 Raptor	04-13			4/115	Q045115	Q065115
YFM 350 Warrior	87-04			4/115	Q045115	Q065115
YFM 350 Wolverine	95-06	4/110	Q045110	4/110	Q045110	Q065110
YFZ 350 Banshee	91-06			4/115	Q045115	Q065115
YFM 400 Kodiak	93-06	4/110	Q045110	4/110	Q045110	Q065110
YFM 450 Grizzly	07-15	4/110	Q045110	4/110	Q045110	Q065110
YFM 450 Kodiak	03-06	4/110	Q045110	4/110	Q045110	Q065110
YFM 450 Wolverine	06-10	4/110	Q045110	4/110	Q045110	Q065110
YFZ 450	04-13			4/115	Q045115	Q065115
YFZ 450 R	09-15			4/115	Q045115	Q065115
YXR 450 Rhino	04-11	4/110	Q045110	4/110	Q045110	Q065110
YFM 550 Grizzly	09-15	4/110	Q045110	4/110	Q045110	Q065110
YFM 600 Grizzly	98-01	4/110	Q045110	4/110	Q045110	Q065110
YFM 660 Grizzly	02-08	4/110	Q045110	4/110	Q045110	Q065110
YFM 660 Raptor	01-05			4/115	Q045115	Q065115
YXR 660 Rhino	04-07	4/110	Q045110	4/110	Q045110	Q065110
YFM 700 Grizzly	07-17	4/110	Q045110	4/110	Q045110	Q065110
YFM 700 Kodiak	16-17	4/110	Q045110	4/110	Q045110	Q065110
YFM 700 Raptor	06-17			4/115	Q045115	Q065115
YXE 700 Wolverine	16-17	4/110	Q045110	4/110	Q045110	Q065110
YXM 700 Viking	14-17	4/110	Q045110	4/110	Q045110	Q065110
YXR 700 Rhino	08-13	4/110	Q045110	4/110	Q045110	Q065110

XPEED

Separadores de nilón

Fáciles de montar y desmontar; entre 1,55 y 2,25kg. de peso.



4PLAY

Separadores universales

Pueden usarse para las ruedas delanteras y traseras. Se adapta a todos los Quads / ATV / UTV o Buggies de todas las marcas, a excepción de POLARIS. Fabricado en acero y galvanizado. Peso sólo 1,05kg.

Referencia: DAT06510



DAT06510

MOTOR

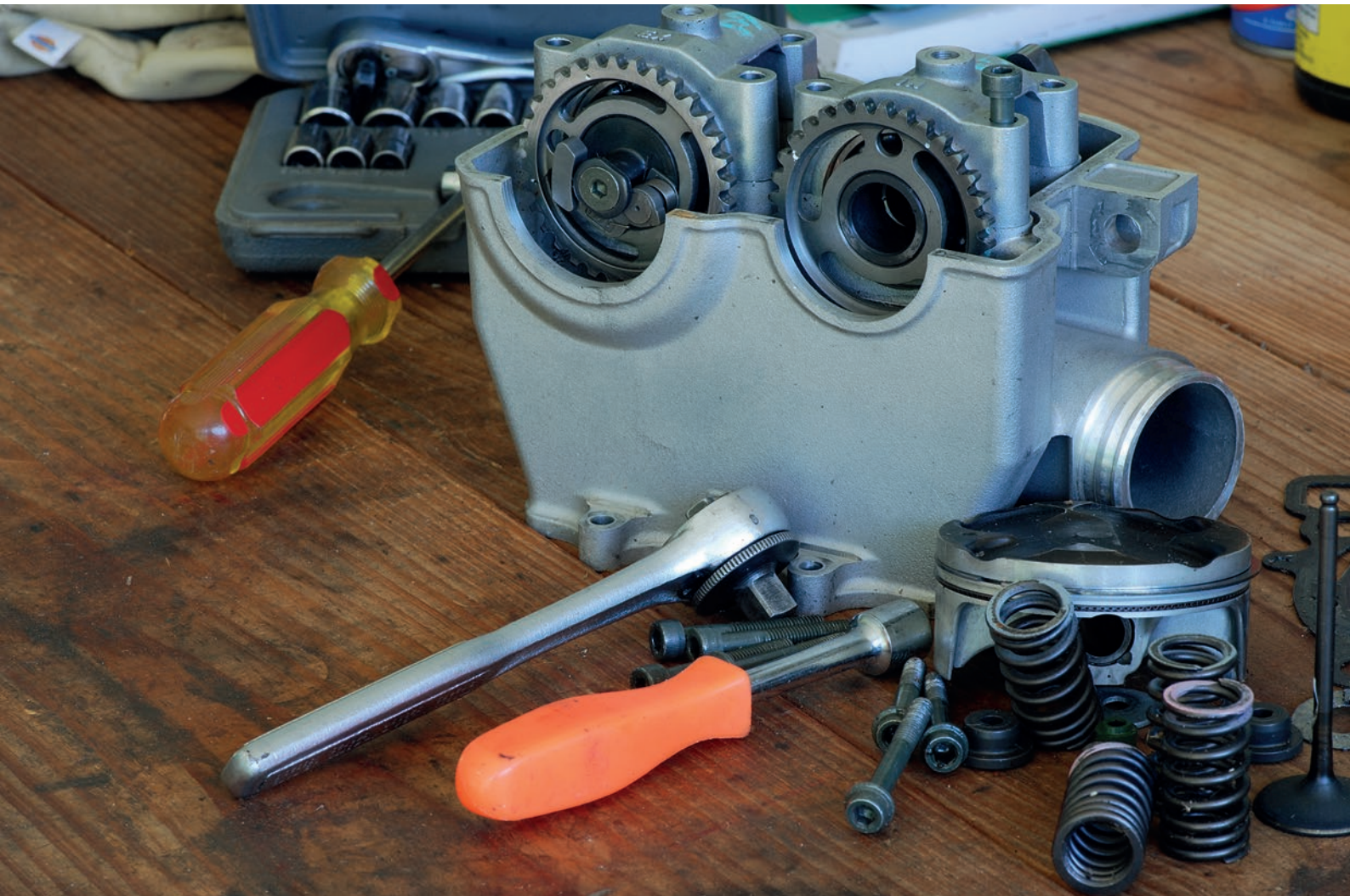



Kit Pistón incluye: Pistón, Segmentos, Bulón, Circlips

HONDA		Cilindro	Kit Pistón	€	Juntas Cilindro COMETIC	€
• TRX 400 EX 96-09	Diámetro: 85 mm Carrera: 70 mm					
86 mm. Sobremedida (407 cc)	12.5:1	Rectificar	M2006	185,40		
• TRX 450R 04-05	Diámetro: 94 mm Carrera: 64.8 mm					
94 mm. Calibre STD. (450 cc)	13.0:1	Original	M2017	185,40		
KTM		Cilindro	Kit Pistón	€	Juntas Cilindro COMETIC	€
• 450 XC 08-09	Diámetro: 89 mm Carrera: 72 mm					
89 mm. Calibre STD. (450 cc)	13.0:1	Original	M9009	185,40		
• 450 XC 08-09 FULL RACE PISTONS	Diámetro: 89 mm Carrera: 72 mm					
89 mm. Calibre STD. (450 cc)	13.5:1	Original	M9010	185,40		
• 525 XC 08-09	Diámetro: 95 mm Carrera: 72 mm					
95 mm. Calibre STD. (525 cc)	13.0:1	Original	M9012	185,40		
POLARIS		Cilindro	Kit Pistón	€	Juntas Cilindro COMETIC	€
• RZR 08-09	* Se sirven en kits de dos pistones. Diámetro: 80 mm Carrera: 75.6 mm					
80 mm. Calibre STD. (760 cc)	12.0:1	Original	M9017	370,80		
80 mm. Calibre STD. (760 cc)	12.5:1	Original	M9018	370,80		
YAMAHA		Cilindro	Kit Pistón	€	Juntas Cilindro COMETIC	€
• YFZ 450 03-05 / 06-10*	Diámetro: 95 mm Carrera: 2.440 (63.4 mm) / 2.496 (63.4 mm)					
95 mm. Calbr STD. (439cc / 449cc) / 13.25:1	13.0:1	Original			MC3066	48,66
95 mm. Calbr STD. (439cc / 449cc) / 13.75:1	13.5:1	Original			MC3066	48,66
• YFM 660 R RAPTOR 02-05 / RHINO 660	Diámetro: 100 mm Carrera: 84 mm					
102 mm. Sobremedida. (686 cc)	12.0:1	Rectificar	M1017A	185,40		
• YFM 700 R RAPTOR 06-10 / RHINO 700FI	Diámetro: 102 mm Carrera: 84 mm					
105 mm. Sobremedida. (727 cc)	10.75	Rectificar y nicasilar	M1041	185,40		

€
281,25



Modelo X-PROJECT

Más ligero, faldas de pistón recubiertas para limitar la fricción, reduce el balanceo del pistón y ranuras anti-detonación, ranura acumuladora, lubricadores de doble salida, forjado, cúpulas sostenidas.

€
231,75



Modelo CP

Ranuras anti-detonación, ranura acumuladora, lubricadores de doble salida, forjado, cúpulas sostenidas.

Kit Pistón incluye: Pistón, Segmentos, Bulón, Circlips



Pistones NAMURA

Pistones de aluminio fundido de anodizado duro, de modo que se optimiza la resistencia mecánica del aluminio al calor. Las faldas tienen revestimiento de Molibdeno (MOS2) y teflón, esto reduce la fricción, extiende la vida útil de los motores; evita que se rayen, ayuda a prevenir daños por la lubricación inadecuada y mejora el sellado. Adicionalmente, en la fabricación de los pistones Namura utilizamos un mayor porcentaje de silicio para obtener una expansión molecular uniforme de los elementos utilizados en su composición.



Segmentos NAMURA

Los segmentos (aros) Namura poseen los mayores estándares de calidad de la industria.

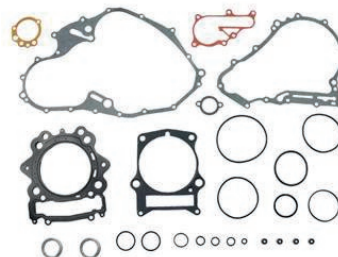

Juntas NAMURA

El kit de juntas de motor Namura dispone, en la gran mayoría de modelos, de todas las juntas, tóricas y retenes del motor entero. El kit de juntas de cilindro dispone de todas las juntas necesarias, para sustituir un pistón.

ARCTIC CAT	Año	Medidas (mm)	KIT PISTÓN		SEGMENTOS		JUNTAS CILINDRO		JUNTAS MOTOR	
			Referencia	€	Referencia	€	Referencia	€	Referencia	€
400 DVX cilindro nikasil	04-08	89.96	NA30002	135,63	NA30002R	25,58	NA30002T	48,76	NA30002F	116,87
		89.97	NA30002-B		NA30002R					
		89.98	NA30002-C		NA30002R					
		90.46	NA30002-2		NA30002-2R					
		90.96	NA30002-4		NA30002-4R					
		91.46	NA30002-6		NA30002-6R					
400	03-08	81,96	NA30010	128,39	NA30010R	22,93	NA30010T	37,19	NA30010F	139,44
		82,46	NA30010-2		NA30010-2R				Manual	96,09
		82,96	NA30010-4		NA30010-4R				Automatico	
500**	03-09	87.45	NA30050	160	NA30050R	24,15	NA30050T	33,02	NA30050F	107,33
		87.46	NA30050-B		NA30050R					
		87.47	NA30050-C		NA30050R					
			NA30050-2		NA30050-2R					
		NA30050-4	NA30050-4R							
650 V-TWIN	04-07	79.96	NA20065	108,86	NA20065R	22,93	NA20065T	68,74	NA20065F	100,84
		80.46	NA20065-2		NA20065-2R					
		80.96	NA20065-4		NA20065-4R					
700	06-08	101.96	NA30014	206,17	NA30014R	32,74	NA30015T	98,68	NA30015F	137,56
		101.97	NA30014-B							
		101.98	NA30014-C							

CAN AM	Año	Medidas (mm)	KIT PISTÓN		SEGMENTOS		JUNTAS CILINDRO		JUNTAS MOTOR	
			Referencia	€	Referencia	€	Referencia	€	Referencia	€
Outlander 400	03-15	90.958	NA80001	165,33	NA80001R	27,10	NA80002T	73,44		
		91.458	NA80001-2		NA80001-2R					
		91.958	NA80001-4		NA80001-4R					
		92.458	NA80001-6		NA80001-6R					
Outlander 500 Renegade 500	07-15 08-15	81.958	NA80000	125,46	NA80000R	24,15	NA80004T	125,54		
		82.458	NA80000-2		NA80000-2R					
		82.958	NA80000-4		NA80000-4R					
Outlander	16-17						NA80004T	125,54	NA80004F	
Commander 800 Defender 800	11-16 2016	90.958 91.458	NA80001 NA80001-2	165,33	NA80001R NA80001-2R	27,10	NA80005T	127,12		
Outlander 800 Renegade 800	06-15 07-15	91.958 92.458	NA80001-4 NA80001-6		NA80001-4R NA80001-6R					
Commander 1000 Defender 1000 Outlander 1000 Renegade 1000	11-17 2016 12-17 12-17									

** Pistón o aros Namura no son intercambiables por aros o pistones originales. / [En Azul pistones Hyperdryve.](#)

Kit Pistón incluye: Pistón, Segmentos, Bulón, Circlips

HONDA	Año	Medidas (mm)	KIT PISTÓN		SEGMENTOS		JUNTAS CILINDRO		JUNTAS MOTOR	
			Referencia	€	Referencia	€	Referencia	€	Referencia	€
TRX 90 Fourtrax	93-16	46.97 47.47 47.97	NA10090 NA10090-2 NA10090-4	74,93	NA10090R NA10090-2R NA10090-4R	16,69	NA10090T (99-05)	20,33	NA10090F (99-05)	44,37
TRX 250 Recon	97-01	68.45 68.70 68.95 69.20 69.45	NA10026 NA10026-1 NA10026-2 NA10026-3 NA10026-4	98,3	NA10025R NA10025-1R NA10025-2R NA10025-3R NA10025-4R	20,72	NA10025T	36,94	NA10025F	73,82
TRX 250 EX Sportrax TRX 250 Recon	01-17 02-17	68.45 68.70 68.95 69.20 69.45	NA10025 NA10025-1 NA10025-2 NA10025-3 NA10025-4	109,24	NA10025R NA10025-1R NA10025-2R NA10025-3R NA10025-4R	20,72	NA10026T	41,64	NA10026F	71,36
TRX 300 12" Fourtrax	88-00	73.95 74.45 74.95 75.45	NA10002 NA10002-2 NA10002-4 NA10002-6	89,05	NA10002R NA10002-2R NA10002-4R NA10002-6R	20,44	NA10002T	30,58	NA10002F	70,23
TRX 300 EX Sportrax**	93-09	73.95 74.45 74.95 75.45	NA10005 NA10005-2 NA10005-4 NA10005-6	110,26	NA10002R NA10002-2R NA10002-4R NA10002-6R	20,44	NA10005T	39,54	NA10005F	78,96
TRX 350 Rancher	99-06	78.46 78.71 78.96 79.21 79.46 79.96	NA10007 NA10007-1 NA10007-2 NA10007-3 NA10007-4 NA10007-6	98,77	NA10007R NA10007-1R NA10007-2R NA10007-3R NA10007-4R NA10007-6R	23,18	NA10007T	37,19	NA10007F	56,89
TRX 400 EX Sportrax 11:1 alta compres.**	99-14	84.97 85.47 85.97 86.47	NA10003 NA10003-2 NA10003-4 NA10003-6	102,64	NA10003R NA10003-2R NA10003-4R NA10003-6R	22,93	NA10003T	60,04	NA10003F (99-04) NA10011F (05-14)	88,16 72,94
TRX 400 Foreman	95-03	85.97 86.22 86.47 86.72 86.97	NA10001 NA10001-1 NA10001-2 NA10001-3 NA10001-4	111,31	NA10001R NA10001-1R NA10001-2R NA10001-3R NA10001-4R	24,37	NA10001T	40,42	NA10001F	69,13
TRX 400 Rancher	04-07	84.97 85.47 85.97	NA10040 NA10040-2 NA10040-4	118,69	NA10040R NA10040-2R NA10040-4R	22,93	NA10040T	49,59	NA10040F	61,31
TRX 420 Rancher	07-17	86.48 86.73 86.98 87.23 87.48 87.73 87.98 88.48	NA10042 NA10042-1 NA10042-2 NA10042-3 NA10042-4 NA10042-5 NA10042-6 NA10042-8	102,59	NA10001-2R NA10001-3R NA10001-4R NA10001-5R NA10001-6R NA10001-7R NA10001-8R NA1000110R	24,37	NA10042T (07-08) NA10043T (09-17)	90,70 88,66	NA10042F (07-08) NA10043F Atomatic (09-14)	93,63 107,89
TRX 450 Foreman	98-04	89.96 90.21 90.46 90.71 90.96 91.46	NA10000 NA10000-1 NA10000-2 NA10000-3 NA10000-4 NA10000-6	118,64	NA10000R NA10000-1R NA10000-2R NA10000-3R NA10000-4R NA10000-6R	25,58	NA10000T	40,42	NA10000F	74,26
TRX 450 R Sportrax 10.2:1 compres.	04-05	93.97 94.47 94.97 95.47	NA10045 NA10045-2 NA10045-4 NA10045-6	112,31	NA10045R NA10045-2R NA10045-4R NA10045-6R	28,07	NA10045T	65,51	NA10045F	109,88
TRX 450 R Sportrax	06-14	95.96 95.97 95.98	NA10046 NA10046-B NA10046-C	185,67	NA10046R	26,63	NA10047T	73,13	NA10047F	107,31
TRX 500 Foreman	05-11	91.96 92.46 92.96 93.46	NA10008 NA10008-2 NA10008-4 NA10008-6	107,50	NA10008R NA10008-2R NA10008-4R NA10008-6R	24,64	NA10050T	73,52	NA10050F	113,41
TRX 500 Rubicon	01-14	91.96 92.46 92.96 93.46	NA10008 NA10008-2 NA10008-4 NA10008-6	107,50	NA10008R NA10008-2R NA10008-4R NA10008-6R	24,64	NA10008T	58,93	NA10008F	114,74
TRX 650 Rincon**	03-05	99.97 100.47 100.97 101.47	NA10009 NA10009-2 NA10009-4 NA10009-6	120,24	NA10009R NA10009-2R NA10009-4R NA10009-6R	28,07	NA10009T	95,12	NA10009F	126,56
TRX 680 Rincon	06-17	101.97 102.47 102.97 103.47	NA10012 NA10012-2 NA10012-4 NA10012-6	132,7	NA10012R NA10012-2R NA10012-4R NA10012-6R	31,50	NA10012T	117,48	NA10012F	164,89

** Pistón o aros Namura no son intercambiables por aros o pistones originales. / En Azul pistones Hyperdryve.

Kit Pistón incluye: Pistón, Segmentos, Bulón, Circlips



Juntas NAMURA

Las juntas de Namura son fabricadas con Klingersil, que es tecnológicamente el mejor material para juntas.

KAWASAKI	Año	Medidas (mm)	KIT PISTÓN		SEGMENTOS		JUNTAS CILINDRO		JUNTAS MOTOR	
			Referencia	€	Referencia	€	Referencia	€	Referencia	€
KLF 220 Bayou	88-02	66.97	NA20001	83,44	NA20001R	19,48	NA20001T	30,83	NA20001F	58,82
		67.47	NA20001-2		NA20001-2R					
		67.97	NA20001-4		NA20001-4R					
		68.47	NA20001-6		NA20001-6R					
KSF 250 Mojave	87-04	73.95	NA20002	114,69	NA20002R	23,68	NA20002T	65,62	NA20002F	85,56
		74.45	NA20002-2		NA20002-2R					
		74.95	NA20002-4		NA20002-4R					
		75.45	NA20002-6		NA20002-6R					
KLF 250 Bayou	03-11	68.97	NA20003	64,62	NA20003R	15,58	NA20003T	26,16	NA20003F	45,45
		69.47	NA20003-2		NA20003-2R					
		69.97	NA20003-4		NA20003-4R					
KLF 300 Bayou KEF 300 Lakota KVF 300 Prairie	86-04 95-03 99-03	75.95	NA20000	92,56	NA20000R	20,72	NA20000T	30,17	NA20000F	56,55
		76.45	NA20000-2		NA20000-2R					
		76.95	NA20000-4		NA20000-4R					
		77.45	NA20000-6		NA20000-6R					
KVF 360 Prairie	03-12	79.98	NA20036	125,77	NA20036R	24,64	NA20036T	32,24	NA20036F	46,75
		80.48	NA20036-2		NA20036-2R					
		80.98	NA20036-4		NA20036-4R					
		81.48	NA20036-6		NA20036-6R					
KFX 400 cilindro nikasil	03-06	89.96	NA30002	135,63	NA30002R	25,58	NA30002T	48,76	NA30002F	116,87
		89.97	NA30002-B		NA30002R					
		89.98	NA30002-C		NA30002R					
		90.46	NA30002-2		NA30002-2R					
		90.96	NA30002-4		NA30002-4R					
		91.46	NA30002-6		NA30002-6R					
KXF 450 R	08-14	95.95				NA20004T	70,48	NA20004F	110,71	
KVF 650 Prairie KVF 650 Brute Force **se requieren 2 unid.	02-03	79.96	NA20065	108,86	NA20065R	22,93	NA20065T	68,74	NA20065F (05-12)	100,84
	05-13	80.46	NA20065-2		NA20065-2R					
KVF 650i Brute Force	06-13	79.96	NA20065	108,86	NA20065R	22,93	NA20075T	87,06	NA20075F	109,55
		80.46	NA20065-2		NA20065-2R					
		80.96	NA20065-4		NA20065-4R					
KVF 700 Prairie KFX 700 V-Force	04-06 04-10	81.96	NA20070	112,73	NA20070R	25,39	NA20070T	76,03	NA20070F	100,84
		82.46	NA20070-2		NA20070-2R					
		82.96	NA20070-4		NA20070-4R					
KVF 750i Brute Force** KRF 750 Tryx** Cilindro Nikasil	05-14	84.95	NA20075	116,68	NA20075R	25,58	NA20075T	87,06	NA20075F	109,55
	08-13	84.96	NA20075-B		NA20075R					
		84.97	NA20075-C		NA20075R					

KTM	Año	Medidas (mm)	KIT PISTÓN		SEGMENTOS		JUNTAS CILINDRO		JUNTAS MOTOR	
			Referencia	€	Referencia	€	Referencia	€	Referencia	€
450 SX	09-10	96.93	NX70070	191,74	NX70070R	19,98	NX70070T	64,43	NA70070F	81,86
		96.94	NX70070-B		NX70070R					
		96.95	NX70070-C		NX70070R					
450 XC ATV	08-09	88.95				NA70067T	45,86	NA70067F	90,98	
505 SX ATV	09-10	99.94				NX70080T	62,72	NX70080F	89,85	

Pistón Hyperdryve

La nueva línea de pistones Hyperdryve está compuesta de un nuevo aluminio hyper-eutectico desarrollado por la Nasa y manipulado para mantener su alta fuerza de tensión hasta 370°C, un 50% más resistente que un pistón de fundición convencional. Esto da Hyperdryve, la fuerza para funcionar bajo condiciones de funcionamiento normalmente reservadas para pistones forjados. Los resultados del porque Namura Hyperdryve es el próximo paso en la evolución de pistones de deportes de motor son claros. Comparacion de Namura Hyperdryve con un típico pistón forjado de aluminio 4032

	Clasificación HRB Temperatura ambiente (Dureza)	Límite de fluencia Temp.perm.a 370° (MPa)	Fuerza de tensión máxima Temp.perm.a 370° (MPa)
Hyperdryve	72	76	97
4032 Forjado	70	31	44

Este aluminio evolutivo combinado con nuestras características ya existentes de cabezas anodizadas* lisas y maquinadas (para mejor reflejo de calor), y faldas recubiertas de MOS2 (dándote arrancadas y frenadas más suaves), concentra las demandas actuales de motores de 4 tiempos 450cc y de 2 tiempos 250cc de altas revoluciones (motores de cross y enduro), a un precio competitivo por debajo de la competencia.

Además de las características y ventajas del pistón habrá una nueva presentación exclusiva para los pistones Hyperdryve Namura. En bote cilíndrico ofreciendo una fácil apertura, de rosca en la parte superior. Dentro están los compartimientos de espuma de protección individuales sosteniendo el pistón, bulón, clips y aros junto con un folleto informativo que enumera las características y ventajas de los pistones Hyperdryve.

Kit Pistón incluye:



Pistón, Segmentos, Bulón, Circlips

POLARIS	KIT PISTÓN				SEGMENTOS		JUNTAS CILINDRO		JUNTAS MOTOR	
	Año	Medidas (mm)	Referencia	€	Referencia	€	Referencia	€	Referencia	€
Trail Boss 250	85-99	71.96	NA50000	86,51	NA50000R	16,55	NA50000T	17,49	NA50000F	21,27
Trail Blazer 250	90-06	72.46	NA50000-2		NA50000-2R					
Xplorer 250	00-02	72.96	NA50000-4		NA50000-4R					
rodamiento pistón		73.46	NA50000-6		NA50000-6R					
		18X23X22	N095051							
300 L	94-00	74.47	NA50003	98,66	NA50003R	16,33	NA50003T	19,06	NA50003F	26,99
Xplorer 300	96-99	74.97	NA50003-2		NA50003-2R					
Xpress 300	96-99	75.47	NA50003-4		NA50003-4R					
rodamiento pistón		75.97	NA50003-6		NA50003-6R					
		18X23X22	N095051							
Hawkeye 300	06-11	77.70	NA50013	112,34	NA50013R	21,69	NA50013T	53,35	NA50013F	79,13
Soprtzman 300	08-10	78.20	NA50013-2		NA50013-2R					
		78.70	NA50013-4		NA50013-4R					
		79.20	NA50013-6		NA50013-6R					
Magnum 325	00-02	77.95	NA50024	98,55	NA50024R	21,69	NA50025T	30,34	NA50025F	77,19
Trail Boss 325	00-02	78.45	NA50024-2		NA50024-2R					
Xpedition 325	00-02	78.95	NA50024-4		NA50024-4R					
		79.45	NA50024-6		NA50024-6R					
Magnum 330	03-06	78.45	NA50025	102,34	NA50024-2R	21,69	NA50025T	30,34	NA50025F	77,19
Trail Blazer 330	08-13	78.95	NA50025-2		NA50024-4R					
Trail Boss 330	03-13	79.45	NA50025-4		NA50024-6R					
Sportsman 335	99-00									
Trail Boss 350	90-94	79.95	NA50001	104,71	NA50001R	18,72	NA50001T	22,07	NA50001F	51,17
		80.45	NA50001-2		NA50001-2R					
		80.95	NA50001-4		NA50001-4R					
rodamiento pistón		81.45	NA50001-6		NA50001-6R					
		18X23X23.8	N09B0021	8,56						
400 L	94-03	82.94	NA50002	90,37	NA50002R	18,72	NA50002T	22,43	NA50002F	65,12
Sport 400	93-02	83.44	NA50002-2		NA50002-2R					
Scrambler 400	95-02	83.94	NA50002-4		NA50002-4R					
rodamiento pistón		84.44	NA50002-6		NA50002-6R					
		18X23X23.8	N09B0021	8,56						
Sportsman 400	01-05			123,25	NA50026R	22,93	NA50026T	77,94	NA50026F	98,94
Sportsman 400 HO	08-14	87.89	NA50026		NA50026-2R					
Hawkeye 400 HO	11-14	88.39	NA50026-2		NA50026-4R					
Ranger 400	03-14	88.89	NA50026-4							
Sportsman 450	06-07									
Sportsman 450	2016	98.94	NA50019	127,56	NA50019R	25,39	NA50019T	98,36		
		99.44	NA50019-2		NA50019R					
		99.94	NA50019-4		NA50019R					
		100.44	NA50019-6		NA50019R					
Xplorer 500	96-03	91.97	NA50004	118,83	NA50004R	24,15	NA50004T	86,70	NA50004F	102,67
Magnum 500	96-03	92.47	NA50004-2		NA50004-2R					
Sportsman 500	96-13	92.97	NA50004-4		NA50004-4R					
Scrambler 500	96-13	93.47	NA50004-6		NA50004-6R					
Predator 500	03-07	99.15	NA50005	121,07	NA50005R	26,63	NA50005T	74,13	NA50005F	99,68
Outlaw 500	06-07	99.65	NA50005-2		NA50005-2R					
		100.15	NA50005-4		NA50005-4R					
		100.65	NA50005-6		NA50005-6R					
									NA50006F	99,68
									NA50006F	(2005-2007)
Sportsman 550	09-14	96.57	NA50011	131,57	NA50011R	25,39	NA50011T	86,23	NA50011F	156,96
		97.07	NA50011-2		NA50011-2R					
		97.57	NA50011-4		NA50011-4R					
		98.07	NA50011-6		NA50011-6R					
Sportsman 570	14-17	98.94	NA50019	127,56	NA50019R	25,39	NA50019T	98,36	NA50019F	145,32
Ranger 570	14-17	99.44	NA50019-2		NA50019R					
RZR 570	12-17	99.94	NA50019-4		NA50019R					
		100.44	NA50019-6		NA50019R					
									NA50020F	145,32
									NA50020F	Sport. (14-16)
Sportsman 700**	02-08	79.96	NA50070	103,14	NA50080R	26,83	NA50070T	68,77	NA50070F	97,11
Ranger 700**	05-09	79.97	NA50070-B		NA50080R					
		79.98	NA50070-C		NA50080R					
					NA50080R					
							NA50080T	122,86	NA50080F	150,02
							Ranger(05-09)		Ranger(05-09)	
Sportsman 800	05-10	79.95	NA50080	101,86	NA50080R	26,83	NA50080T	122,86	NA50080F	150,02
Ranger 800	2010	79.96	NA50080-B		NA50080R					
RZR 800	08-10	79.97	NA50080-C		NA50080R					
RZR 800 S	08-10									
Sportsman 800 HO	08-09	79.95	NA50081	101,87	NA50080R	26,83	NA50080T	122,86	NA50080F	150,02
RZR 800	11-13	79.96	NA50081-B		NA50080R					
RZR 800 S HO	09-13	79.97	NA50081-C		NA50080R					
RZR 800 4 HO	09-10									
Sportsman 850	09-17	86.93	NA50012	109,22	NA50012R	24,15	NA50012T	118,94	NA50012F	219,73
Scrambler 850	13-17	86.94	NA50012-B		NA50012-2R					
		86.95	NA50012-C		NA50012-4R					
		87.43	NA50012-2		NA50012-4R					
		87.93	NA50012-4		NA50012-6R					
		88.43	NA50012-6							

Kit Pistón incluye: Pistón, Segmentos, Bulón, Circlips



			KIT PISTÓN		SEGMENTOS		JUNTAS CILINDRO		JUNTAS MOTOR	
RZR 900 XP EFI Todos	11-14	93,00	NA50090							
RZR 4 XP 900 Todos compre. 10.6:1	12-14	93,01 93,02	NA50090-B NA50090-C	142,92	NA50090R	26,14	NA50090T	147,78	NA50090F	207,15
Ace 900	16-17									
Ranger 900 XP	13-17									
Ranger XP 900 Crew	14-17									
RZR 900	15-17									
RZR 900 *4*	14-17	93,00	NA50091							
General 1000	16-17	93,01	NA50091-B	130,46	NA50091R	26,14	NA50092T	134,27	NA50092F	194,31
General 1000 *4*	2017	93,02	NA50091-C							
Ranger XP 1000	2017									
Ranger XP 1000 Crew	2017									
RZR XP 1000	14-17									
RZR XP 1000 *4*	14-17									

SUZUKI		Año	Medidas (mm)	Referencia	€	Referencia	€	Referencia	€	Referencia	€
LT 80 QuadSport	87-06			NA30080 NA30080-2 NA30080-4 N09B0001	44,43 7,29	NA30080R NA30080-2R NA30080-4R	9,53	NA30080T	7,98	NA30080F	33,24
rodamiento pistón			12X16X15.8								
LT-F 160 Quadrunner	89-04			NA30160 NA30160-2 NA30160-4	81,95	NA30160R NA30160-2R NA30160-4R	16,74	NA30160T	25,97	NA30160F	49,95
LT-F 250 Quadrunner	88-02			NA30000		NA30000R					
LT-Z 250 QuadSport	04-09			NA30000-2	81,73	NA30000-2R	21,88	NA30008T LT-Z 250	24,70	NA30008F LT-Z 250	43,35
LT-F 250 Ozark	02-12			NA30000-4 NA30000-6		NA30000-4R NA30000-6R					
LT-F 300 King Quad	99-02			NA30001		NA30001R					
LT 4 WD King Quad	91-98			NA30001-2 NA30001-4	91,56	NA30001-2R NA30001-4R	19,48	NA30001T	23,29	NA30001F	40,97
LT-Z 400	03-14			NA30002 NA30002-B NA30002-C NA30002-2 NA30002-4 NA30002-6	135,63	NA30002R NA30002R NA30002R NA30002-2R NA30002-4R NA30002-6R	25,58	NA30002T	48,76	NA30002F (03-08) NA30013F (09-13)	116,87 97,23
LT-A 400 Eiger**	02-07			NA30010		NA30010R				NA30010F (02-14)	139,44
LT-F 400 Eiger**	02-07			NA30010-2		NA30010-2R				NA30011F (02-07)	96,09
LT-A 400 King Quad**	08-16			NA30010-4	128,39	NA30010-4R	22,93	NA30010T	37,19	NA30012F (08-14) LT-A 400	139,44
LT-F 400 King Quad**	08-16										
LT-A 450 King Quad								NA30016T	99,78	NA30016F	
LT-R 450	06-08			NA30005 NA30005-B NA30005-C	177,88	NA30005R	33,46	NA30005T	64,37	NA30005F	112,25
LT-F 500 Quadrunner**	98-02			NA30051		NA30050R				NA30049F	90,43
LT-A 500 Quadmaster**	00-01			NA30051-B NA30051-C NA30051-2 NA30051-4	160,58	NA30050R NA30050R NA30050-2R NA30050-4R	24,15	NA30050T	33,02	NA30050F LT-F NA30050F LT-A	107,37
LT-A 500 Vinson**	02-07			NA30050		NA30050R				NA30049F	90,43
LT-F 500 Vinson**	02-07			NA30050-B NA30050-C NA30050-2 NA30050-4	160	NA30050R NA30050R NA30050-2R NA30050-4R	24,15	NA30050T	33,02	NA30050F LT-A	107,37
LT-A 500 King Quad cilindro SCEM	09-16			NA30053 NA30053-B NA30053-C NA30053-2 NA30053-4	157,43	NA30050R NA30050R NA30050R NA30050-2R NA30050-4R	24,15	NA30053T	101,97	NA30053F	162,01
LT-A 700 King Quad	05-07			NA30014		NA30014R				NA30015F	137,56
LT-A 700 King Quad Sobremedida a 750cc	05-07			NA30014-B NA30014-C	206,17	NA30014R NA30014R NA30014R	32,74	NA30015T	98,69	NA30015F	137,56
LT-V 700 Twin Peaks	04-05			NA30015		NA30015R				NA30015R	
				NA30015-B NA30015-C	207,66	NA30015R NA30015R NA30015R	32,74	NA30015T	98,69	NA30015F	137,56
				NA20070		NA20070R				NA20070F	
				NA20070-2 NA20070-4	112,73	NA20070-2R NA20070-4R	25,39	NA20070T	76,03	NA20070F	100,84
LT-A 750 King Quad	08-17			NA30015		NA30015R				NA30015F (08-13)	137,56
				NA30015-B NA30015-C	207,66	NA30015R NA30015R NA30015R	32,74	NA30015T (08-13)	98,69	NA30015F (08-13)	137,56

** Pistón o aros Namura no son intercambiables por aros o pistones originales. / En Azul pistones Hyperdryve.

Kit Pistón incluye: Pistón, Segmentos, Bulón, Circlips

YAMAHA	Año	Medidas (mm)	KIT PISTÓN		SEGMENTOS		JUNTAS CILINDRO		JUNTAS MOTOR	
			Referencia	€	Referencia	€	Referencia	€	Referencia	€
YFA 1 125 Breeze	91-04		NA40019		NA40019R		NA40019T		NA40019F	
YFM 125 Grizzly	04-13		NA40019-2	78,91	NA40019-2R	17,85				57,27
			NA40019-4		NA40019-4R					
YFS 200 Blaster alta compres.	88-06	65.94 66.44 66.94 67.44 67.94	NA40002 NA40002-2 NA40002-4 NA40002-6 NA40002-8	90,57	NA40002R NA40002-2R NA40002-4R NA40002-6R NA40002-8R	15,58	NA40002T	25,00	NA40002F	32,02
rodamiento pistón		16x21x22.5	N09B0051	8,87						
YFS 200 Blaster original	88-06	65.92 66.42 66.92 67.42 67.92	NA40003 NA40003-2 NA40003-4 NA40003-6 NA40003-8	82,36	NA40002R NA40002-2R NA40002-4R NA40002-6R NA40002-8R	15,58	NA40002T	25,00	NA40002F	32,02
rodamiento pistón		16x21x22.5	N09B0051	8,87						
YFS 200 Blaster original EMIGO	88-06	66.25 66.50 66.75	E1834651 E1834652 E1834653	52,08			NA40002T	25,00	NA40002F	32,02
rodamiento pistón		16x21x22.5	N09B0051	8,87						
YFB 250 Timberwolf	92-98	70.95	NA40015		NA40015R					
YFM 250 Bear Tracker	99-04	71.45	NA40015-2	82,28	NA40015-2R	20,45	NA40015T	37,38	NA40015F	60,04
YFM 250 Bruin	05-06	71.95	NA40015-4		NA40015-4R					
YFM 250 Big Bear	07-09	72.95	NA40015-6		NA40015-6R					
YFZ 350 Banshee** alta compres.	87-06	63.94 64.19 64.44 64.69 64.94 65.19 65.44 65.69 65.94 66.19 66.44	NA40000 NA40000-1 NA40000-2 NA40000-3 NA40000-4 NA40000-5 NA40000-6 NA40000-7 NA40000-8 NA40000-9 NA40000-10	89,63	NA40000RN NA400001RN NA400002RN NA400003RN NA400004RN NA400005RN NA400006RN NA400007RN NA400008RN NA400009RN NA4000010RN	15,58	NA40001T	23,35	NA40001F	42,57
rodamiento pistón		16x21x22.5	N09B0051	8,87						
YFZ 350 Banshee original falda 20% más de grosor	87-06	63.95 64.45 64.70 64.95 65.45	NA40001 NA40001-2 NA40001-3 NA40001-4 NA40001-6	98,58	NA40000R NA40000-2R NA40000-3R NA40000-4R NA40000-6R	16,69	NA40001T	23,35	NA40001F	42,57
rodamiento pistón		16x21x22.5	N09B0051	8,87						
YFM 350 Big Bear	87-99	82.95 83.45 83.95 84.45	NA40005 NA40005-2 NA40005-4 NA40005-6	104,71	NA40005R NA40005-2R NA40005-4R NA40005-6R	23,18	NA40005T	38,79	NA40005F 2x4 (87-98) NA40006F 4x4 (97-99)	57,69 81,92
YFM 350 Bruin	04-06	82.95	NA40005		NA40005R				NA40006F	81,92
YFM 350 Grizzly	07-14	83.45	NA40005-2	104,71	NA40005-2R	23,18	NA40005T	38,79	Wolverine(95-05)	
YFM 350 Wolverine	95-09	83.95 84.45	NA40005-4 NA40005-6		NA40005-4R NA40005-6R				NA40017F resto	51,64
YFM 350 Raptor	04-13	82.95	NA40005		NA40005R					
YFM 350 Warrior	87-04	83.45 83.95 84.45	NA40005-2 NA40005-4 NA40005-6	104,71	NA40005-2R NA40005-4R NA40005-6R	23,18	NA40005T	38,79	NA40005F	57,69
YFM 400 Big Bear "semi."	00-12	83.00	NA40006		NA40005R				NA40005F	57,69
YFM 400 Kodiak "semi."	93-99	83.25 83.50 84.00 84.50	NA40006-1 NA40006-2 NA40006-4 NA40006-6	103,47	NA40005-1R NA40005-2R NA40005-4R NA40005-6R	23,18	NA40005T	38,79	(93-98) NA40006F (99-10)	81,92
YFM 400 Grizzly	07-08	84.42	NA40008		NA40008R					
YFM 400 Kodiak "autom."	00-06	84.92 85.42	NA40008-2 NA40008-4	117,81	NA40008-2R NA40008-4R	23,18	NA40008T	60,62	NA40008F	92,94
YFM 450 Kodiak	03-06	84.45	NA40011		NA40011R					
YFM 450 Grizzly	07-14	84.95	NA40011-2	123	NA40011-2R	22,93	NA40008T	60,62	NA40008F	92,94
YXR 450 Rhino	06-10	85.45	NA40011-4		NA40011-4R					
YFZ 450	04-13	94.95	NA40009H	171,29			NA40009T	55,23	NA40009F	76,97
YFZ 450 R	09-17	94.96	NA40009-B	112,31	NA40009R	25,39	YFZ 450 NA40014T (09-14) YFZ450R	48,51	YFZ 450 NA40014F (09-14)YFZ450R	96,26
YFZ 450 nikasil		94.97	NA40009-BH NA40009-CH	171,29 171,29	NA40009R NA40009R					
YFM 550 Grizzly	09-14						NA40021T	82,77	NA40021F	116,42
YFM 600 Grizzly	98-01	95.00 95.50 96.00	NA40007 NA40007-2 NA40007-4	128,33	NA40007R NA40007-2R NA40007-4R	25,58	NA40007T	59,07	NA40007F	110,24
YFM 660 Raptor	01-05	99.97	NA40004		NA40004R		NA40004T	78,80	NA40004F	127,89
YFM 660 Grizzly	02-08	100.47	NA40004-2	123,94	NA40004-2R	27,79	(Raptor)		(Raptor)	
YXR 660 Rhino	04-07	100.97 101.47	NA40004-4 NA40004-6		NA40004-4R NA40004-6R		NA40010T	91,95	NA40010F	125,43
YFM 700 Raptor	06-14	101.97	NA40012						NA40012F	119,91
YFM 700 Grizzly	07-13	101.98	NA40012-B	172,87	NA40012R	31,36	NA40012T	84,98	(Raptor)	
YXR 700 Rhino	08-13	101.99	NA40012-C						NA40013F (Grizzly-Rhino)	123,14

** Pistón o aros Namura no son intercambiables por aros o pistones originales. / En Azul pistones Hyperdryve.

		KIT PISTÓN	SEGMENTOS	JUNTAS CILINDRO	JUNTAS MOTOR
YFM 700 Grizzly	14-15	NA40013	179,72	NA40012T	84,98
YFM 700 Raptor	15-17	NA40013-B			
YXC 700 Vicking	14-17	NA40013-C			
YFM 700 Grizzly	16-17			NA40025T	84,98
YFM 700 Kodiak	16-17				NA40025F
YXE 700 Wolverine	16-17				144,11



DAT094621K

PSYCHIC 4PLAY Cilindros Kits de cilindro

Lo más rápido, fiable y económico, sustituir el cilindro y pistón por el kit de cilindrada, ahorrarás tiempo y dinero, pero también aumentarás cilindrada, convirtiendo tu vieja moto en un vehículo con nuevas prestaciones. El pistón Namura supera ampliamente las características y calidades originales.

El Kit se entrega con cilindro, pistón, segmentos, bulón, circlips y kit de juntas.

* DAT09463K Es necesario mandrinar 0,8mm el cárter para poder alojar la camisa.

** DAT094621K Usar junta de culata gruesa (la delgada sólo para moto).

		KIT DE CILINDRO	CILINDRO DE RECAMBIO	KIT PISTÓN RECAMBIO	JUNTAS DE CILINDRO			
HONDA	Año	Descripción	Referencia	€	Referencia	€	Referencia	€
TRX 300 EX	93-09	dimensionado 80 mm	DAT094511K	308,12	NA10010	106,59	NA10010T	18,48
TRX 400 Sportrax	99-09	89 mm (de 400 a 440cc)	DAT09463K	333,60	NA10004	123,25	NA10004T	50,50
KAWASAKI	Año	Descripción	Referencia	€	Referencia	€	Referencia	€
KFX 400	03-06	94 mm (de 400 a 435cc)	**DAT094621K	396,92	NA30002-16	138,06	NA3000216T	81,59
					NA3000216B	138,06		
					NA3000216C	138,06		
SUZUKI	Año	Descripción	Referencia	€	Referencia	€	Referencia	€
LT-Z 400	03-12	94 mm (de 400 a 435cc)	**DAT094621K	396,92	NA30002-16	138,06	NA3000216T	81,59
					NA3000216B	138,06		
					NA3000216C	138,06		
YAMAHA	Año	Descripción	Referencia	€	Referencia	€	Referencia	€
YFZ 450	04-05	Std. 95 mm (439cc)	DAT09470K	394,98	DMX09151	209,62	NA40009H	171,29
							NA40009-BH	171,29
							NA40009-CH	171,29
YFZ 450	04-05	98 mm (de 439cc a 468cc)			DMX091511	233,03		
YFZ 450	06-13	Std. 95 mm (449cc)	DAT09470K	394,98	DMX09151	209,62	NA40009H	171,29
							NA40009-BH	171,29
							NA40009-CH	171,29
YFZ 450	06-13	98 mm (de 449cc a 478cc)			DMX091511	233,03		
YFZ 450 R	09-13	Std. 95 mm (449cc)	DAT09472K	394,98	DMX09159	220,86	NA40009H	171,29
							NA40009-BH	171,29
							NA40009-CH	171,29
YFZ 450 R	09-13	98 mm (de 449cc a 478cc)			DMX091591	233,03		
YFM 700 Grizzly	07-13	Std. 102 mm	DAT09474K	564,13	DAT09474	338,98	NA40012	172,87
YXR 700 Rhino	08-13						NA40012-B	172,87
							NA40012-C	172,87
YFM 700 Grizzly	14-15	Std. 102 mm	DAT09476K	564,13	DAT09474	338,98	NA40013	172,87
YXC 700 Viking	14-17						NA40013-B	172,87
							NA40013-C	172,87
YFM 700 Raptor	06-14	Std. 102 mm	DAT09473K	564,13	DAT09473	338,98	NA40012	172,87
							NA40012-B	172,87
							NA40012-C	172,87
YFM 700 Raptor	15-17	Std. 102 mm	DAT09475K	564,13	DAT09473	338,98	NA40013	172,87
							NA40013-B	179,72
							NA40013-C	179,72

VÁLVULAS DE ADMISIÓN VÁLVULAS DE ESCAPE

CAN AM	Año	Referencia	€	Referencia	€
330 Outlander	04-05	DAU09017I	22,32	DAU09017E	26,78
400 Outlander	03-15	DAU09017I	22,32	DAU09017E	26,78
500 Renegade	09-15	DAU09017I	22,32	DAU09017E	26,78
650 Outlander	06-15	DAU09017I	22,32	DAU09017E	26,78
800 Outlander	06-15	DAU09017I	22,32	DAU09017E	26,78
800 Commander	11-15	DAU09017I	22,32	DAU09017E	26,78
800 Renegade	07-15	DAU09017I	22,32	DAU09017E	26,78
1000 Outlander	2014	DAU09017I	22,32	DAU09017E	26,78
1000 Renegade	2014	DAU09017I	22,32	DAU09017E	26,78
1000 Commander	2014	DAU09017I	22,32	DAU09017E	26,78

VÁLVULAS DE ADMISIÓN VÁLVULAS DE ESCAPE

HONDA	Año	Referencia	€	Referencia	€
TRX 250 X Fourtrax	87-92	DAU09003I	19,22	DAU09003E	20,70
TRX 250 Recon	97-01	DAU09004I	17,55	DAU09004E	20,16
TRX 250 Recon	02-14	DAU09005I	18,50	DAU09005E	21,35
TRX 250 EX Sportrax	01-14	DAU09006I	19,50	DAU09006E	22,40
TRX 300 EX Sportrax	93-09	DAU09003I	19,22	DAU09003E	20,70
TRX 350 Rancher	00-06	DAU09009I	18,90	DAU09009E	22,00
TRX 400 Sportrax	99-14	DAU09011I	19,30	DAU09011E	22,95
TRX 420 Rancher	09-13	DAU09014I	20,10	DAU09014E	22,15
TRX 450 Foreman	98-02	DAU09012I	20,30	DAU09012E	22,80
TRX 450 R	04-05	DAU09013I	20,16	DAU09013E	25,45
TRX 450 R	06-14	DXU09502I	24,61	DXU09503E	24,29
TRX 500 Rubicon	01-14	DAU09011I	19,30	DAU09011E	22,95
TRX 650 Rincon	03-05	DAU09015I	19,90	DAU09015E	22,00
TRX 680 Rincon	06-14	DAU09015I	19,90	DAU09015E	22,00

VÁLVULAS DE ADMISIÓN VÁLVULAS DE ESCAPE

KAWASAKI	Año	Referencia	€	Referencia	€
KLF 220 Bayou	88-02	DAU09021I	18,90	DAU09021E	24,25
KLF 250 Bayou	03-11	DAU09021I	18,90	DAU09021E	24,25
KSF 250 Mojave	87-04	DAU09022I	18,50	DAU09022E	21,35
KVF 300 Brute Force	12-14	DAU09020I	20,55	DAU09020E	22,15
KVF 300 Prairie	99-02	DAU09020I	20,55	DAU09020E	22,15
KVF 360 Prairie	03-12	DAU09026I	19,90	DAU09026E	22,80
KLF 400 Bayou	93-99	DAU09024I	18,50	DAU09024E	21,35
KVF 400 Prairie	98-02	DAU09024I	18,50	DAU09024E	21,35
KFX 400	03-06	DAU09025I	18,90	DAU09025E	23,75
KFX 450 R	08-13	DXU09164I	21,16	DXU09164E	20,53
KVF 650 Brute Force	05-13	DAU09027I	20,55	DAU09027E	22,00
KVF 650i Brute Force	06-14	DAU09027I	20,55	DAU09027E	22,00
KVF 650 Prairie	02-03	DAU09027I	20,55	DAU09027E	22,00
KFX 700 V-Force	04-09	DAU09027I	20,55	DAU09027E	22,00
KVF 700 Prairie	04-06	DAU09027I	20,55	DAU09027E	22,00
KRF 750 Teryx	08-12	DAU09027I	20,55	DAU09027E	22,00
KVF 750i Brute Force	05-14	DAU09027I	20,55	DAU09027E	22,00

VÁLVULAS DE ADMISIÓN VÁLVULAS DE ESCAPE

POLARIS	Año	Referencia	€	Referencia	€
300 Sportsman	08-10	DAU09194I	21,04	DAU09194E	22,68
325 Magnum	2002	DAU09194I	21,04	DAU09194E	22,68
330 ATP	04-05	DAU09194I	21,04	DAU09194E	22,68
330 Hawkeye	06-10	DAU09194I	21,04	DAU09194E	22,68
330 Magnum	03-05	DAU09194I	21,04	DAU09194E	22,68
330 Trail Blazer	08-13	DAU09194I	21,04	DAU09194E	22,68
330 Trail Boss	02-13	DAU09194I	21,04	DAU09194E	22,68
400 Hawkeye	11-14	DAU09193I	21,04	DAU09193E	22,68
400 Ranger	10-14	DAU09193I	21,04	DAU09193E	22,68
400 Sportsman	01-04	DAU09193I	21,04	DAU09193E	22,68
400 Sportsman	08-14	DAU09193I	21,04	DAU09193E	22,68
425 Xpedition	00-02	DAU09193I	21,04	DAU09193E	22,68
450 Sportsman	06-07	DAU09193I	21,04	DAU09193E	22,68
500 ATP	04-05	DAU09193I	21,04	DAU09193E	22,68
500 Magnum	96-03	DAU09193I	21,04	DAU09193E	22,68
500 Ranger	06-13	DAU09193I	21,04	DAU09193E	22,68
500 Scrambler	97-12	DAU09193I	21,04	DAU09193E	22,68
500 Sportsman	00-08	DAU09193I	21,04	DAU09193E	22,68
500 Worker	99-01	DAU09193I	21,04	DAU09193E	22,68
500 Xplorer	1997	DAU09193I	21,04	DAU09193E	22,68
550 Sportsman	09-14	DAU09191I	21,04	DAU09191E	22,68
570 RZR	12-15	DAU09190I	20,80	DAU09190E	23,20
570 Ranger	14-16	DAU09190I	20,80	DAU09190E	23,20
570 Sportsman	14-16	DAU09190I	20,80	DAU09190E	23,20
570 Sportsman ACE	2015	DAU09190I	20,80	DAU09190E	23,20
700 Ranger	2009	DAU09195I	20,30	DAU09195E	23,68
700 Sportsman X2 EFI	2008	DAU09195I	20,30	DAU09195E	23,68
800 Ranger	10-15	DAU09195I	20,30	DAU09195E	23,68
800 RZR	09-14	DAU09195I	20,30	DAU09195E	23,68
800 RZR "S"	09-14	DAU09195I	20,30	DAU09195E	23,68



Válvulas de admisión y escape



- Válvulas de escape:
- Exceden la calidad original
 - Fabricadas en acero inoxidable (SUH35HT)

- Válvulas de admisión:
- Especificaciones originales
 - Fabricadas en acero (SUH3)

Válvulas forjadas, construidas de una pieza, pulidas con radio modificado, "nitride coating" que reduce la fricción y alarga la vida.

ESPECIFICACIONES

Tolerancia (mm)	+/-0.10	+/-0.01	+/-0.20
Referencia	Diámetro cabeza	Diámetro tija	altura total
DAU09000E	20	5	65,4
DAU09000I	23	5	65,8
DAU09002E	28	5,5	89,95
DAU09002I	32	5,5	91,3
DAU09003E	22,5	5,45	93
DAU09003I	25,5	5,45	93,6
DAU09004E	27	5,5	82,2
DAU09004I	31	5,5	81,8
DAU09005E	27	5,5	88,5
DAU09005I	31,5	5,5	89
DAU09006E	26,8	5,5	89,4
DAU09006I	31,4	5,5	89,8
DAU09007I	32	5,45	91,3
DAU09008E	27,5	5,5	90,52
DAU09008I	31	5,5	93,07
DAU09009E	28	5,46	81,88
DAU09009I	34	5,45	81,4
DAU09010E	28	5,5	82
DAU09010I	34	5,5	81,4
DAU09011E	29	5,45	101,2
DAU09011I	33	5,45	102,7
DAU09012E	30	5,5	82
DAU09012I	35	5,5	81,4
DAU09013E	30	5,5	84,3
DAU09013I	36	5,48	84,6
DAU09014E	33	6	91,15
DAU09014I	38	6	94,4
DAU09015E	30,5	5,45	101
DAU09015I	34,5	5,5	102,6
DAU09016E	34	7	100,5
DAU09016I	40	7	102,7
DAU09017E	27	5	89,3
DAU09017I	31	5	90,9
DAU09020E	31	7	99
DAU09020I	37	7	100,7
DAU09021E	28	5,5	85,5
DAU09021I	32	5,5	86,7
DAU09022E	24,7	5,5	87,16
DAU09022I	29	5,5	89,09
DAU09024E	27	5,5	96,8
DAU09024I	30	5,5	96,9
DAU09025E	29	5	81,32
DAU09025I	36	5	82,47
DAU09026E	36	7	99,1
DAU09026I	41	7	100,6
DAU09027E	26	5	92,8
DAU09027I	30	5	91,4
DAU09028E	28,9	5,45	81

Válvulas de admisión y escape



ESPECIFICACIONES

Tolerancia (mm)	+/-0.10	+/-0.01	+/-0.20
Referencia	Diámetro cabeza	Diámetro tija	altura total
DAU09028I	36	5,45	81,95
DAU09031E	22	5,5	93,38
DAU09031I	26	5,5	97,61
DAU09032E	28	5,46	87,8
DAU09032I	33	5,5	88,66
DAU09033E	27	5	92,55
DAU09033I	30,6	5	93,05
DAU09151E	32	6	96,2
DAU09151I	38	6	102,3
DAU09152E	20	5,6	64,8
DAU09152I	23	5	65,3
DAU09156E	34	7	100,5
DAU09156I	40	7	102,6
DAU09157E	32	7	91,7
DAU09157I	37	7	97
DAU09158E	32	6	92,7
DAU09158I	30	6	100,6
DAU09159E	27,97	4,91	73,14
DAU09159I	26,98	4,41	74,25
DAU09160I	27	4,4	75,07
DAU09163E	21,48	4,9	64,63
DAU09163I	22,99	4,9	54,04
DAU09164E	31	5,36	82
DAU09164I	35,94	5,39	83,29
DAU09166E	32,96	5,37	94,17
DAU09166I	35,93	5,41	94,28
DAU09189I	23,8	5,45	64,5
DAU09190I	37,60	5,47	95,90
DAU09190E	32,40	5,45	96,50
DAU09191I	35,97	5,95	95,75
DAU09191E	30,96	5,94	89,30
DAU09192I	30,00	5,49	118,60
DAU09192E	25,99	5,48	115,99
DAU09193I	31,00	5,95	100,99
DAU09193E	26,99	5,94	101,20
DAU09194I	35,95	5,95	101,03
DAU09194E	32,00	5,95	101,23
DAU09195I	35,00	5,97	114,65
DAU09195E	30,02	5,96	115,57
DAU09197I	34,46	5,48	95,80
DAU09197E	29,10	5,44	96,58
DXU09500E2	25	5,5	91,5
DXU09500I2	30	5,5	92
DXU09518E2	28,50	6	92,5
DXU09518I2	34	6	93,8
DXU09521E	28	5	75
DXU09521I	27	4,5	76,3
DXU09524I	27	4,7	77,2

Año	Referencia	€	Referencia	€	
800 RZR "4"	10-14	DAU09195I	20,30	DAU09195E	23,68
800 Sportsman EFI	08-14	DAU09195I	20,30	DAU09195E	23,68
850 Scrambler	13-15	DAU09192I	19,10	DAU09192E	21,15
850 Sportsman	09-15	DAU09192I	19,10	DAU09192E	21,15
900 Ranger	13-15	DAU09197I	20,72	DAU09197E	22,36
900 RZR XP	11-14	DAU09190I	20,30	DAU09190E	23,68
900 RZR XP "4"	12-14	DAU09190I	20,30	DAU09190E	23,68
900 RZR 50/60"	2015	DAU09197I	20,72	DAU09197E	22,36
1000 RZR XP	14-16	DAU09190I	20,30	DAU09197E	22,36
1000 RZR XP "4"	14-16	DAU09190I	20,30	DAU09197E	22,36

VÁLVULAS DE ADMISIÓN VÁLVULAS DE ESCAPE

SUZUKI		Año	Referencia	€	Referencia	€
LT-F 250 Ozark	02-14	DAU09032I	18,50	DAU09032E	22,05	
LT-F 250 Quadrunner	89-02	DAU09032I	18,50	DAU09032E	22,05	
LT-Z 250 QuadSport	04-09	DAU09032I	18,50	DAU09032E	22,05	
LT-F 300 King Quad	99-02	DAU09032I	18,50	DAU09032E	22,05	
LT-A 400 Eiger	02-11	DAU09033I	19,10	DAU09033E	20,08	
LT-A 400 King Quad	08-14	DAU09033I	19,10	DAU09033E	20,08	
LT-F 400 Eiger	02-11	DAU09033I	19,10	DAU09033E	20,08	
LT-F 400 King Quad	08-14	DAU09033I	19,10	DAU09033E	20,08	
LT-Z 400	03-14	DAU09025I	18,90	DAU09025E	23,75	
LT-R 450	06-09	DAU09028I	24,97	DAU09028E	22,41	
LT-A 450 King Quad	07-14	DAU09033I	19,10	DAU09033E	20,08	
LT-A 500 King Quad	09-14	DAU09033I	19,10	DAU09033E	20,08	
LT-A 500 Quadmaster	00-02	DAU09033I	19,10	DAU09033E	20,08	
LT-A 500 Vinson	02-07	DAU09033I	19,10	DAU09033E	20,08	
LT-F 500 Vinson	02-07	DAU09033I	19,10	DAU09033E	20,08	
LT-F 500 Quadrunner	98-05	DAU09033I	19,10	DAU09033E	20,08	
LT-V 700 Twin Peaks	04-05	DAU09027I	20,55	DAU09027E	22,00	
LT-A 750 King Quad	08-13	DAU09166I	22,55	DAU09166E	24,55	

VÁLVULAS DE ADMISIÓN VÁLVULAS DE ESCAPE

YAMAHA		Año	Referencia	€	Referencia	€
YFM 80 Badger	92-01	DAU09152I	18,63	DAU09152E	19,22	
YFM 80 Grizzly	05-08	DAU09152I	18,63	DAU09152E	19,22	
YFM 80 Raptor	02-08	DAU09152I	18,63	DAU09152E	19,22	
YFM 100 Champ	87-91	DAU09152I	18,63	DAU09152E	19,22	
YFM 125 Grizzly	04-13	DAU09152I	18,63	DAU09152E	19,22	
YFM 125 Raptor	11-13	DAU09152I	18,63	DAU09152E	19,22	
YFB 250 Timberwolf	92-00	DXU09518I	22,89	DXU09518E	22,89	
YFM 250 Bear Tracker	99-04	DXU09518I	22,89	DXU09518E	22,89	
YFM 250 Bruin	05-06	DXU09518I	22,89	DXU09518E	22,89	
YFM 250 Big Bear	07-08	DXU09518I	22,89	DXU09518E	22,89	
YFM 250 Raptor	08-14	DXU09518I	22,89	DXU09518E	22,89	
YFM 350 Bruin	04-06	DAU09156I	22,30	DAU09156E	21,74	
YFM 350 Grizzly	07-14	DAU09156I	22,30	DAU09156E	21,74	
YFM 350 Grizzly IRS	07-14	DAU09156I	22,30	DAU09156E	21,74	
YFM 350 Raptor	04-13	DAU09156I	22,30	DAU09156E	21,74	
YFM 350 Warrior	87-04	DAU09156I	22,30	DAU09156E	21,74	
YFM 350 Wolverine "semi"	95-05	DAU09156I	22,30	DAU09156E	21,74	
YFM 350 Wolverine	06-09	DAU09156I	22,30	DAU09156E	21,74	
YFM 400 Big Bear PRO	00-06	DAU09156I	22,30	DAU09156E	21,74	
YFM 400 Big Bear IRS	07-12	DAU09156I	22,30	DAU09156E	21,74	
YFM 400 Grizzly IRS	2007	DAU09156I	22,30	DAU09156E	21,74	
YFM 400 Kodiak "semi"	93-99	DAU09156I	22,30	DAU09156E	21,74	
YFM 400 Kodiak	00-02	DAU09156I	22,30	DAU09156E	21,74	
YFM 450 Grizzly	07-14	DAU09016I	24,17	DAU09016E	21,72	
YFM 450 Kodiak	2003	DAU09016I	24,17	DAU09016E	21,72	
YFM 450 Kodiak IRS	04-06	DAU09016I	24,17	DAU09016E	21,72	
YFM 450 Wolverine	06-11	DAU09016I	24,17	DAU09016E	21,72	
YFZ 450	04-11	DXU09524I DXU09521I (CENTRO)	25,40 24,61	DXU09521E	25,08	
YFZ 450	12-13	DAU09160I DAU09159I (CENTRO)	21,50 21,50	DAU09159E	23,10	
YFZ 450 R	09-16	DXU09524I DXU09521I (CENTRO)	25,40 24,61	DXU09521E	25,08	
YFM 660 Grizzly	02-06	DAU09158I	20,55	DAU09158E	21,75	
YFM 660 Raptor	01-05	DAU09158I	20,55	DAU09158E	21,75	
YXR 660 Rhino	03-07	DAU09158I	20,55	DAU09158E	21,75	
YFM 700 Raptor	06-16	DAU09151I	19,50	DAU09151E	23,60	
YFM 700 Grizzly	07-15	DAU09151I	19,50	DAU09151E	23,60	
YXR 700 Rhino	08-12	DAU09151I	19,50	DAU09151E	23,60	
YXM 700 Viking	14-17	DAU09151I	19,50	DAU09151E	23,60	

RUEDAS Y NEUMÁTICOS

MOTOR

ADMISIÓN / ESCAPE
REFRIGERACIÓN

ELECTRICO

SUSPENSIÓN / DIRECCIÓN

FRENOS

TRANSMISIÓN

CONTROLES Y MANDOS

CHASIS

ACCESORIOS

4PLAY Retenes de válvula

Se entregan en paquetes de 10 unidades.

€
14,90

Referencia	Ø Interior (mm)	Ø Exterior (mm)	Altura (mm)	Material	Ref. Origen
DAT09090	4,5 / 5,4	9,1	2,7	Teflón	14730-028-013
DAT09092	4,5 / 7,35	10,46	8,33	Vitón	12209-GB4-671
DAT09093	4,9 / 7,6	10,7	8,4	NBR	12209-107-760
DAT09094	5 / 7,5	10,8	7,9	Vitón	12208-413-003 12209-KL4-005
DAT09159	6,2 / 10,2				
DAT09175	5 / 8,5	10,7	8,3	NBR	92049-1062
DAT09176	6,2 / 10,1	13,6	9,3	Vitón	92049-016
DAT09177	4,5 / 8,4	11	7,8	Vitón	92049-1218
DAT09178	4,8 / 7,88	11	8,3	Vitón	09289-05003 09289-05015
DAT09180	4,3 / 7,55	10,1	8,8	Vitón	09289-05011 92049-S006
DAT09181	4,4 / 8,3	10,9	8	Vitón	2HX-12119-00
DAT09183	5,1 / 9,5				
DAT09184	6,1 / 10,2				



HONDA	Año	Ref. Original	Referencia	Descripción
TRX 90 Fourtrax	93-14	12209-GB4-671	DAT09092	VITON
TRX 200 Fourtrax	90-96	12209-KL4-005	DAT09094	VITON
TRX 250 Recon	97-01	12208-413-003	DAT09094	VITON
TRX 250 EX Sportrax	01-14	12209-KL4-005	DAT09094	VITON
TRX 250 X Fourtrax	87-92	12209-KL4-005	DAT09094	VITON
TRX 300 EX Sportrax	93-09	12209-KL4-005	DAT09094	VITON
TRX 300 Fourtrax	89-00	12209-KL4-005	DAT09094	VITON
TRX 350 Rancher	00-06	12209-KL4-005	DAT09094	VITON
TRX 400 Sportrax	99-14	12209-KL4-005	DAT09094	VITON
*TRX 400 Rancher	04-07	12209-KL4-005	DAT09094	VITON
TRX 400 Foreman	95-03	12209-KL4-005	DAT09094	VITON
TRX 450 Foreman	98-03	12209-KL4-005	DAT09094	VITON
TRX 450 R	04-14	12209-KL4-005	DAT09094	VITON
TRX 500 Rubicon	01-14	12209-KL4-005	DAT09094	VITON
TRX 650 Rincon	03-05	12209-KL4-005	DAT09094	VITON
TRX 680 Rincon	06-14	12209-KL4-005	DAT09094	VITON

KAWASAKI	Año	Ref. Original	Referencia	Descripción
KLF 220 Bayou	88-02	92049-1062	DAT09175	NBR
KLF 250 Bayou	03-11	92049-1062	DAT09175	NBR
KSF 250 Mojave	88-04	92049-1062	DAT09175	VITON
KEF 300 Lakota	95-03	92049-016	DAT09176	VITON
KLF 300 Bayou	88-04	92049-016	DAT09176	VITON
KVF 300 Prairie	99-02	92049-016	DAT09176	VITON
KVF 360 Prairie	02-13	92049-016	DAT09176	VITON
KLF 400 Bayou	93-99	92049-016	DAT09176	VITON
KFX 400	03-06	92049-S006	DAT09180	VITON
KVF 400 Prairie	98-02	92049-1062	DAT09175	VITON
KFX 450 R	10-12	92049-1062	DAT09175	NBR
KVF 650 Brute Force	05-13	92049-1218	DAT09177	VITON
KVF 650 Prairie	02-03	92049-1218	DAT09177	VITON
KFX 700 V-Force	04-09	92049-1218	DAT09177	VITON
KVF 700 Prairie	04-06	92049-1218	DAT09177	VITON
KRF 750 Terryx	08-12	92049-1218	DAT09177	VITON
KVF 750 Brute Force	06-12	92049-1218	DAT09177	VITON

SUZUKI	Año	Ref. Original	Referencia	Descripción
LT-Z 90 QuadSport	07-09	09289-05003	DAT09178	VITON
LT-F 160 Quadrunner	89-04	09289-05015	DAT09178	VITON
LT-F 250 Ozark	02-14	09289-05015	DAT09178	VITON
LT-F 250 Quadrunner	88-02	09289-05003	DAT09178	VITON
LT-Z 250 QuadSport	04-09	09289-05015	DAT09178	VITON
LT-F 300 King Quad	99-02	09289-05003	DAT09178	VITON
LT-A 400 Eiger	02-07	09289-05011	DAT09180	VITON
LT-A 400 King Quad	08-09	09289-05011	DAT09180	VITON
LT-F 400 Eiger	02-07	09289-05011	DAT09180	VITON
LT-Z 400 QuadSport	03-08	09289-05011	DAT09180	VITON
LT-A 450 King Quad	07-09	09289-05011	DAT09180	VITON
LT-R 450	06-09	09289-05015	DAT09178	VITON

LT-A 500 Quadrunner	00-01	09289-05011	DAT09180	VITON
LT-A 500 King Quad	2009	09289-05011	DAT09180	VITON
LT-A 500 Vinson	02-07	09289-05011	DAT09180	VITON
LT-F 500 Quadrunner	98-02	09289-05011	DAT09180	VITON
LT-A 700 King Quad	05-07	09289-05015	DAT09178	VITON
LT-V 700 Twin Peaks	04-05	09289-05015	DAT09178	VITON
LT-A 750 King Quad	08-11	09289-05015	DAT09178	VITON

YAMAHA	Año	Ref. Original	Referencia	Descripción
YFM 50 Raptor	04-08	2HX-12119-00	DAT09181	VITON
YFM 80 Badger	92-01	2HX-12119-00	DAT09181	VITON
YFM 80 Grizzly	05-08	2HX-12119-00	DAT09181	VITON
YFM 80 Raptor	02-08	2HX-12119-00	DAT09181	VITON
YFM 100 Champ	87-91	2HX-12119-00	DAT09181	VITON
YFM 125 Grizzly	04-13	2HX-12119-00	DAT09181	VITON
YFA1 125 Brezze	89-04	2HX-12119-00	DAT09181	VITON
YFB 250 Timberwolf	92-00	5H0-12119-00	DAT09183	VITON
YFM 250 Bear Tracker	99-04	5H0-12119-00	DAT09183	VITON
YFM 250 Big Bear	07-08	5H0-12119-00	DAT09183	VITON
YFM 250 Bruin	05-06	5H0-12119-00	DAT09183	VITON
YFM 350 Big Bear	87-99	1J7-12119-01-00	DAT09184	VITON
YFM 350 Big Bear	96-99	M01-12129-00	DAT09159	VITON
YFM 350 Bruin 2x4	04-06	M01-12129-00	DAT09159	VITON
YFM 350 Bruin 4x4	04-06	M01-12129-00	DAT09159	VITON
YFM 350 Grizzly 2x4	07-11	M01-12129-00	DAT09159	VITON
YFM 350 Grizzly 4x4	07-12	M01-12129-00	DAT09159	VITON
YFM 350 Grizzly 4x4 IRS	07-11	M01-12129-00	DAT09159	VITON
YFM 350 R	04-14	M01-12129-00	DAT09159	VITON
YFM 350 Warrior	87-04	1J7-12119-01-00	DAT09184	VITON
YFM 350 Wolverine semi.	95-05	M01-12129-00	DAT09159	VITON
YFM 400 Big Bear IRS	07-12	M01-12129-00	DAT09159	VITON
YFM 400 Big Bear PRO	07-12	M01-12129-00	DAT09159	VITON
YFM 400 Grizzly IRS	2007	M01-12129-00	DAT09159	VITON
YFM 400 Kodiak	00-06	M01-12129-00	DAT09159	VITON
YFM 400 Kodiak semi.	93-99	M01-12129-00	DAT09159	VITON
YFM 450 Kodiak	03-06	M01-12129-00	DAT09159	VITON
YFM 450 Grizzly	07-14	M01-12129-00	DAT09159	VITON
YFM 450 Wolverine	06-11	M01-12129-00	DAT09159	VITON
YXR 450 Rhino	06-09	M01-12129-00	DAT09159	VITON
YFM 600 Grizzly	98-01	1J7-12119-01-00	DAT09184	VITON
YFM 660 Grizzly	02-08	5H0-12119-00	DAT09183	VITON
YFM 660 Raptor	01-05	5H0-12119-00	DAT09183	VITON
YFM 700 Grizzly	07-14	5H0-12119-00	DAT09183	VITON
YFM 700 Raptor	06-14	5H0-12119-00	DAT09183	VITON
TT 600	1986	1J7-12119-01-00	DAT09184	VITON
XT 600	86-95	1J7-12119-01-00	DAT09184	VITON
XV 535 Virago	87-99	1J7-12119-01-00	DAT09184	VITON
SRX 600	1986	1J7-12119-01-00	DAT09184	VITON
XVS 650 V-Star	98-11	1J7-12119-01-00	DAT09184	VITON



Caja de pastillas de reglaje



Referencia	Descripción	€
DMX0943100	Diámetro 7,48mm - Grosor de 120 a 350 - 141 unidades	145,95
DMX0943300	Diámetro 8,90mm - Grosor de 172 a 260 - 69 unidades	87,95
DMX0943200	Diámetro 9,48mm - Grosor de 120 a 350 - 141 unidades	155,95

Pastillas de reglaje (bolsa con 3 unidades)

€
10,95

Set de 3 unidades
Pastilla de 7,48mm



€
10,95

Set de 3 unidades
Pastilla de 9,48mm



Referencia	Medida
DMX0943101	120
DMX0943102	125
DMX0943103	130
DMX0943104	135
DMX0943105	140
DMX0943106	145
DMX0943107	150
DMX0943108	155
DMX0943109	160
DMX0943110	165
DMX0943111	170
DMX0943112	175
DMX0943113	180
DMX0943114	185
DMX0943115	190
DMX0943116	195
DMX0943117	200
DMX0943118	205
DMX0943119	210
DMX0943120	215
DMX0943121	220
DMX0943122	225
DMX0943123	230
DMX0943124	235

Referencia	Medida
DMX0943125	240
DMX0943126	245
DMX0943127	250
DMX0943128	255
DMX0943129	260
DMX0943130	265
DMX0943131	270
DMX0943132	275
DMX0943133	280
DMX0943134	285
DMX0943135	290
DMX0943136	295
DMX0943137	300
DMX0943138	305
DMX0943139	310
DMX0943140	315
DMX0943141	320
DMX0943142	325
DMX0943143	330
DMX0943144	335
DMX0943145	340
DMX0943146	345
DMX0943147	350

Referencia	Medida
DMX0943201	120
DMX0943202	125
DMX0943203	130
DMX0943204	135
DMX0943205	140
DMX0943206	145
DMX0943207	150
DMX0943208	155
DMX0943209	160
DMX0943210	165
DMX0943211	170
DMX0943212	175
DMX0943213	180
DMX0943214	185
DMX0943215	190
DMX0943216	195
DMX0943217	200
DMX0943218	205
DMX0943219	210
DMX0943220	215
DMX0943221	220
DMX0943222	225
DMX0943223	230
DMX0943224	235

Referencia	Medida
DMX0943225	240
DMX0943226	245
DMX0943227	250
DMX0943228	255
DMX0943229	260
DMX0943230	265
DMX0943231	270
DMX0943232	275
DMX0943233	280
DMX0943234	285
DMX0943235	290
DMX0943236	295
DMX0943237	300
DMX0943238	305
DMX0943239	310
DMX0943240	315
DMX0943241	320
DMX0943242	325
DMX0943243	330
DMX0943244	335
DMX0943245	340
DMX0943246	345
DMX0943247	350

€
10,95

Set de 3 unidades
Pastilla de 8,90mm

Referencia	Medida
DMX0943301	172
DMX0943302	176
DMX0943303	180
DMX0943304	184
DMX0943305	188
DMX0943306	192
DMX0943307	196
DMX0943308	200

Referencia	Medida
DMX0943309	204
DMX0943310	208
DMX0943311	212
DMX0943312	216
DMX0943313	220
DMX0943314	224
DMX0943315	228
DMX0943316	232

Referencia	Medida
DMX0943317	236
DMX0943318	240
DMX0943319	244
DMX0943320	248
DMX0943321	252
DMX0943322	256
DMX0943323	260

Bielas completas

Bielas completas con bulón de cigüeñal, separadores y rodamientos.



		BIELA							BULÓN	RODAMIENTO BIELA	ARANDELA	
ARCTIC CAT	Año	Referencia	€	A	B	C	D	E	Ø	Largo	Medidas	Medidas
DVX 400	04-08	DAT09165	105,96	107	20	43	20	22	35	61,85	35x43x21.75	
		BIELA							BULÓN	RODAMIENTO BIELA	ARANDELA	
HONDA	Año	Referencia	€	A	B	C	D	E	Ø	Largo	Medidas	Medidas
TRX 250 EX Sportrax	01-08	DAT09196	106,39	105,5	15	38	18	18	30	54	30x38x17.8	35X45X1.0
TRX 250 Recon	97-13	DAT09196	106,39	105,5	15	38	18	18	30	54	30x38x17.8	35X45X1.0
TRX 300 EX Sportrax	93-09	DAT09453	58,04	122	17	41	20	20	33	59,8	33x40.7x19.75	33.2 X 50.9 X 1.0
TRX 300 FW	88-00	DAT09453	58,04	122	17	41	20	20	33	59,8	33x40.7x19.75	33.2 X 50.9 X 1.0
TRX 350 Rancher	00-06	DAT09172	70,47	116	20	41	20	17	33	60		33 X 51X 1.0
TRX 400 EX Sportrax	99-09	DAT09250	100,00	122,6	20	43	17	21	34	66	34x43x20	
TRX 400 Foteman	95-03	DAT09212	61,98	122,4	19	41	20	20	33	62,9	33x41x19.5	33.1 X 50.94 X 1.0
TRX 450 Foreman	98-04	DAT09212	61,98	122,4	19	41	20	20	33	62,9	33x41x19.5	33.1 X 50.94 X 1.0
TRX 450 R	04-05	DAT09194	131,24	111,5	21	46	19	23,5	35	62,9		35 X 54.8 X 1
TRX 450 R	06-12	DAT09193	131,24	105,5	19	42	18	20	34	65		34.2 X 52.9 X 2
		BIELA							BULÓN	RODAMIENTO BIELA	ARANDELA	
KAWASAKI	Año	Referencia	€	A	B	C	D	E	Ø	Largo	Medidas	Medidas
KLF 300 Bayou	86-05	DAT09164	76,54	117	18	43	18	22,6	32	58,1	32x42.85x22.3	32,2x51,7x1,2
KEF 300 Lakota	95-03	DAT09164	76,54	117	18	43	18	22,6	32	58,1	32x42.85x22.3	32,2x51,7x1,2
KVF 300 Prairie	99-02	DAT09164	76,54	117	18	43	18	22,6	32	58,1	32x42.85x22.3	32,2x51,7x1,2
KFX 400	03-06	DAT09165	105,96	107	20	43	20	22	35	61,85	35x43x21.75	
		BIELA							BULÓN	RODAMIENTO BIELA	ARANDELA	
KTM	Año	Referencia	€	A	B	C	D	E	Ø	Largo	Medidas	Medidas
450 XC		DMX09024	120,54	129	20	43	21,9	21,9	35	64,7	35x43x21.8	35,5x55x1,0
525 XC		DMX09024	120,54	129	20	43	21,9	21,9	35	64,7	35x43x21.8	35,5x55x1,0
		BIELA							BULÓN	RODAMIENTO BIELA	ARANDELA	
POLARIS	Año	Referencia	€	A	B	C	D	E	Ø	Largo	Medidas	Medidas
250 Trail Blazer	90-06	DAT09166	79,40	120	23	33	18	18	25	56	25x32.75x17.6	25x42x0,8
250 Trail Boss	87-99	DAT09166	79,40	120	23	33	18	18	25	56	25x32.75x17.6	25x42x0,8
250 Xplorer	00-01	DAT09166	79,40	120	23	33	18	18	25	56	25x32.75x17.6	25x42x0,8
300	94-95	DAT09166	79,40	120	23	33	18	18	25	56	25x32.75x17.6	25x42x0,8
300 Xplorer	96-99	DAT09166	79,40	120	23	33	18	18	25	56	25x32.75x17.6	25x42x0,8
300 Xpress	96-99	DAT09166	79,40	120	23	33	18	18	25	56	25x32.75x17.6	25x42x0,8
335 Sportsman	99-00	DAT09167	86,54	130	23	43	22	22	34	71	34x42.8x21.6	34,15x51,7x1
350 Sportsman	1993	DAT09169	67,12	130	23	34	20	20	26	61	27x33.8x19.7	26,2x44x1
350 Trail Boss	90-93	DAT09169	67,12	130	23	34	20	20	26	61	27x33.8x19.7	26,2x44x1
400 Hawkeye	11-13	DAT09191	116,28	127,5	23	43	22	22	34	71		
400 L	94-95	DAT09169	67,12	130	23	34	20	20	26	61	27x33.8x19.7	26,2x44x1
400 Ranger	10-13	DAT09191	116,28	127,5	23	43	22	22	34	71		
400 Scrambler	2000	DAT09169	67,12	130	23	34	20	20	26	61	27x33.8x19.7	26,2x44x1
400 Sportsman	94-97	DAT09169	67,12	130	23	34	20	20	26	61	27x33.8x19.7	26,2x44x1
400 Sportsman	2001	DAT09167	86,54	130	23	43	22	22	34	71	34x42.8x21.6	34,15x51,7x1
400 Sportsman HO	08-13	DAT09191	116,28	127,5	23	43	22	22	34	71		
400 Sport	94-99	DAT09169	67,12	130	23	34	20	20	26	61	27x33.8x19.7	26,2x44x1
400 Trail Boss	94-95	DAT09169	67,12	130	23	34	20	20	26	61	27x33.8x19.7	26,2x44x1
400 Xplorer	95-01	DAT09169	67,12	130	23	34	20	20	26	61	27x33.8x19.7	26,2x44x1
400 Xpress	95-01	DAT09169	67,12	130	23	34	20	20	26	61	27x33.8x19.7	26,2x44x1
425 Magnum	95-98	DAT09167	86,54	130	23	43	22	22	34	71	34x42.8x21.6	34,15x51,7x1
450 Outlaw	08-10	DMX09024	120,54	129	20	43	21,9	21,9	35	64,7	35x43x21.8	35,5x55x1,0
450 Sportsman	06-07	DAT09191	116,28	127,5	23	43	22	22	34	71		
500 ATP	04-05	DAT09191	116,28	127,5	23	43	22	22	34	71		
500 Magnum	99-00	DAT09168	82,90	127,5	23	43	22	22			36.15x42.8x21.6	
500 Rancher	98-00	DAT09168	82,90	127,5	23	43	22	22			36.15x42.8x21.6	
500 Ranger EFI	06-07	DAT09191	116,28	127,5	23	43	22	22	34	71		
500 Scrambler	97-12	DAT09168	82,90	127,5	23	43	22	22			36.15x42.8x21.6	
500 Sportsman	96-00	DAT09168	82,90	127,5	23	43	22	22			36.15x42.8x21.6	
500 Sportsman	01-13	DAT09191	116,28	127,5	23	43	22	22	34	71		
500 Worker	2001	DAT09191	116,28	127,5	23	43	22	22	34	71		
500 Xplorer	1997	DAT09168	82,90	127,5	23	43	22	22			36.15x42.8x21.6	

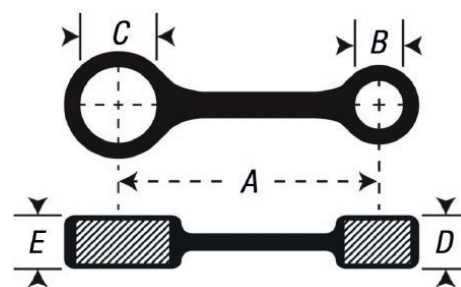

525 Outlaw	07-11	DMX09024	120,54	129	20	43	21,9	21,9	35	64,7	35x43x21.8	35,5x55x1,0
700 Ranger	06-09	DAT09406	59,83	132	20	42	24	24			39x19x1.5	
700 Sportsman	02-10	DAT09406	59,83	132	20	42	24	24			39x19x1.5	
800 Ranger	08-12	DAT09408	62,12	135	18	39	18	24.2			39x19x1.5	
800 Sportsman	05-12	DAT09408	62,12	135	18	39	18	24.2			39x19x1.5	

				BIELA				BULÓN		RODAMIENTO BIELA		ARANDELA	
SUZUKI	Año	Referencia	€	A	B	C	D	E	Ø	Largo	Medidas	Medidas	
LTF 250 Ozark	02-09	DAT09171	58,04	115,5	16	39	14	18	30	53	30x38.8x17.7	24,3x38x1,5	
LT-F 250 Quad Runner	88-02	DAT09171	58,04	115,5	16	39	14	18	30	53	30x38.8x17.7		
LT-Z 400	03-12	DAT09165	105,96	107	20	43	20	22	35	61,85	35x43x21.75		
LT-R 450	06-09	DAT09190	96,82	107	19	42	19	22	34	61			
LT-A 400 Eiger	02-07	DAT09197	126,66	105,5	20	38	22	18	34	59,75	36x43x21.7	34x52x1	
LT-A 400 King Quad	08-13	DAT09197	126,66	105,5	20	38	22	18	34	59,75	36x43x21.7	34x52x1	
LT-A 500 King Quad	07-14	DAT09251	132,52										

				BIELA				BULÓN		RODAMIENTO BIELA		ARANDELA	
YAMAHA	Año	Referencia	€	A	B	C	D	E	Ø	Largo	Medidas	Medidas	
YFS 200 Blaster	88-07	DAT97307	96,02	110	21	29	18	17	22	56,6	22x28.9x16.8	22,3x36,5x1	
YFZ 350 Banshee	87-06	DAT97306	79,56	110	21	29	18	17	22	52,9	22x28.9x16.8	22,2x36,6x1	
YFZ 350 Banshee "biela 5mm más larga"	87-06	DAT09134	89,25	115	21	29	18	17	22	52,7	22x28.9x16.8	22,2x36,9x1	
YFM 350 Warrior	87-04	DAT09173	64,12	112,5	19	41	20	20	33	58	34x40.8x19.9		
YFM 350 Big Bear	96-99	DAT09173	64,12	112,5	19	41	20	20	33	58	34x40.8x19.9		
YFM 350 Wolverine	95-05	DAT09173	64,12	112,5	19	41	20	20	33	58	34x40.8x19.9		
YFM 350 Raptor	04-12	DAT09173	64,12	112,5	19	41	20	20	33	28	34x40.8x19.9		
YFM 660 Raptor	2001	DAT09174	106,81	136,5	22	45	22	22	37	73,8			
YFM 660 Raptor	02-05	DAT091742	106,81	136,5	22	45	22	22	37	73,8			
YFM 660 Grizzly	02-08	DAT091742	106,81	136,5	22	45	22	22	37	73,8			
YXR 660 Rhino	04-07	DAT091742	106,81	136,5	22	45	22	22	37	73,8			

4PLAY Cigüeñal completo reforzado

YAMAHA	Año	Referencia	€
YFZ 350 Banshee	89-06	DAT09400	390,00

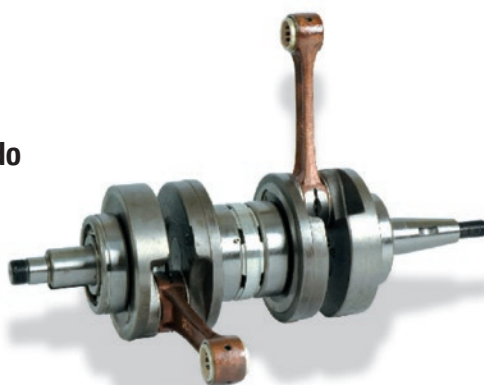

4PLAY Retenes motor

HONDA	Año	Referencia	€
TRX 400 EX Sportrax	99-09	DAT09606	10,36

YAMAHA	Año	Referencia	€
YFS 200 Blaster	88-07	DAT09641	17,08
YFZ 350 Banshee	87-06	DAT09223	13,86
YFM 350 Warrior	87-04	DAT09643	12,67
YFM 350 Raptor	04-14	DAT09643	12,67
YFM 660 Raptor	01-05	DAT09645	9,80



4PLAY Kit discos de embrague / Kit placas de fricción

El Kit de Embrague reforzado consta de los discos de fricción más los discos metálicos o de separación y los muelles. La calidad es superior a los discos originales, en algunos casos puede ser como mínimo igual al original.

* Kit solo placas de fricción

** Kit sin muelles



ARCTIC CAT	Año	Referencia	€
DVX 400	04-06	DAT03915H	65,37
DVX 400	07-08	DAT03652H	71,49

HONDA	Año	Referencia	€
TRX 250 R Fourtrax	89-92	DAT03903H	39,12
TRX 250 EX Sportrax	01-14	DAT03651H	28,78
TRX 250 Recon	97-14	DAT03651H	28,78
TRX 300 EX Sportrax	93-14	DAT03903H	39,12
TRX 400 EX Sportrax "kit Emgo"	99-14	E8859203	33,65
TRX 400 EX Sportrax	99-14	DAT03900H	55,32
TRX 450 R Sportrax	04-14	DAT03918H	63,45

KAWASAKI	Año	Referencia	€
KFX 400	03-04	DAT03915H	65,37
KFX 400	03-04	DMC03883C*	32,52
KFX 400	05-06	DAT03652H	71,49
KFX 400	05-06	DAT03434C*	32,64
KFX 450 R	08-14	DAT03658H	71,52

KTM	Año	Referencia	€
400 SX	09-12	DMX03209H	73,14
450 XC	08-12	DMX03208H	94,30
505 SX	09-12	DMX03209H	73,14
525 XC	08-12	DMX03208H	94,30

POLARIS	Año	Referencia	€
PREDATOR 500	03-07	DAT03917H	68,96

SUZUKI	Año	Referencia	€
LT-Z 250 QuadSport	04-11	DAT03672H	41,60
LT-F 250 Ozark	2003	DAT03671H	45,28
LT-F 250 Ozark	2004	DAT03672H	41,60
LT-F 250 Ozark	05-14	DAT03671H	45,28
LTZ 400	03-04	DAT03915H	65,37
LTZ 400	03-04	DMC03883C*	32,52
LTZ 400	05-14	DAT03652H	71,49
LTZ 400	05-14	DAT03434C*	32,64
LT-F 400 Eiger	02-07	DAT03684H	58,39
LT-F 400 King Quad	08-11	DAT03684H	58,39
LT-R 450	06-11	DAT03653H	74,45

YAMAHA	Año	Referencia	€
YFS 200 Blaster	88-06	DAT03901H	38,41
YFS 200 Blaster	88-06	DMC05807C*	21,84
YFM 250 Timberwolf	89-98	DAT05214**	24,66
YFM 250 Bear Tracker	99-03	DAT05214**	24,66
YFM 250 Bruin	04-06	DAT05214**	24,66
YFM 250 Big Bear	07-08	DAT05214**	24,66
YFM 250 Raptor	08-13	DAT03656H	45,78
YFZ 350 Banshee	87-06	DAT03902H	51,22
YFM 350 X Warrior "kit Emgo"	87-04	E8816753**	36,06
YFM 350 X Warrior	87-04	DAT03905H	53,54
YFM 350 Raptor "kit Emgo"	04-13	E8816753**	36,06
YFM 350 Raptor	04-13	DAT03905H	53,54
YFZ 450	04-05	DAT03916	74,34
YFZ 450	06-11	DAT03662H	66,59
YFM 660 Raptor	01-05	DAT03904H	59,66
YFM 700 Raptor	06-15	DAT03916H	68,34



NA8000CG



NA-10003CG



NA30002CG

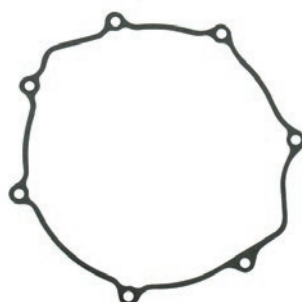

NA30005CG



NA30053CG

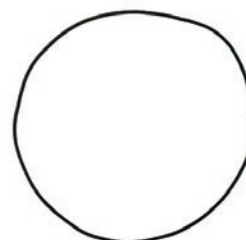

NA50011CG*



Juntas embrague o variador



*Junta embrague interior

ARCTIC CAT	Año	Referencia	Referencia Original	€
400 DVX	04-08	NA30002CG	11061-S071 11482-07G00 3446-357	13,32
400 FIS Manual	03-08	NA30010CG	11482-38F10	20,39
500 H1 TRV 500 XT 500 TRV Core	09-10	NA-11010CG	0830-174 0831-096	21,45
550 todos	09-16	NA-11010CG	0830-012 0830-174 0831-096	21,45
650 H1 650 H1 TRV 650 Mud Pro H1	2008-11	NA-11010CG	0830-012 0830-174 0831-096	21,45
700 Auto FIS/TRV	06-08	NA30015CG	11482-31G00-00	11,56
700 (resto)	09-16	NA-11010CG	0830-012 0830-174 0831-096	21,45
1000 Thundercat	08-10	NA11009CG	0830-137	21,45
1000 TRV	09-16	NA11009CG	0830-137	21,45
1000S	2011	NA11009CG	0830-137	21,45
1000 GT	2012	NA11009CG	0830-137	21,45
1000 LTD	2011	NA11009CG	0830-137	21,45
1000 XT	13-16	NA11009CG	0830-137	21,45
1000 Prowler	09-16	NA11009CG	0830-137	21,45
1000 Wildcat	12-16	NA11009CG	0830-137	21,45

CAN AM	Año	Referencia	Referencia Original	€
Outlander 500 Outlander Max 500 Renegade 500 EFI	07-15 07-15 08-15	NA80000CG	420430120 420430123 420430124 420430126	23,68
Outlander 570 Outlander Max 570 Outlander 570 L Renegade 570 EFI	16-17 16-17 16-17 16-17	NA80000CG	420430120 420430123 420430124 420430126	23,68
Outlander 650 Outlander Max 650	06-16 09-16	NA80000CG	420430120 420430123 420430124 420430126	23,68
Outlander 800 Outlander 800 R Outlander 800 HO Outlander 800 EFI	06-15 06-15 06-15 06-15	NA80000CG	420430120 420430123 420430124 420430126	23,68
Outlander Max 800 Outlander Max 800 R Outlander Max 800 HO Outlander Max 800 EFI	06-15 06-15 06-15 06-15	NA80000CG	420430120 420430123 420430124 420430126	23,68
Renegade 800 Renegade 800 R	07-15 07-15	NA80000CG	420430120 420430123 420430124 420430126	23,68
Commander 800 EFI Commander 800 R Commander 800 STD Commander 800 XT	11-16 11-16 11-16 11-16	NA80000CG	420430120 420430123 420430124 420430126	23,68
Defender HDB Outlander 850 Outlander Max 850 Renegade 850	2016 16-17 16-17 16-17	NA80000CG	420430120 420430123 420430124 420430126	23,68
Outlander 1000 Outlander Max 1000 Renegade 1000 Commander 1000 Commander Max 1000	12-17 12-17 12-17 11-17 11-17	NA80000CG	420430120 420430123 420430124 420430126	23,68
Defender HD 10 Maverick 1000 Maverick Max 10000	2016 14-17 14-17	NA80000CG	420430120 420430123 420430124 420430126	23,68

HONDA	Año	Referencia	Referencia Original	€
TRX 90 EX	07-16	NX10070CG	11394-035-010 11394-GW8-681	5,77
TRX 90	93-06	NX10070CG	11394-035-010 11394-GW8-681	5,77
TRX 250 X Fourtrax	85-87	NA10002CG	11394-HC4-840 11394-HM5-A10	13,01
TRX 300 Fourtrax	88-00	NA10002CG	11394-HC4-840 11394-HM5-A10	13,01
TRX 300 FW	88-00	NA10002CG	11394-HC4-840 11394-HM5-A10	13,01
TRX 400 Sportrax	99-04	NA10003CG	11394-KCY-670 11394-KCY-671	11,88

KAWASAKI	Año	Referencia	Referencia Original	€
KLF 300 Bayou	96-05	NA20000CG	11060-1715	12,05
KFX 400	03-06	NA30002CG	11061-S071 11482-07G00 3446-357	13,32

POLARIS	Año	Referencia	Referencia Original	€
Sportsman Ace 325 EFI	14-16	NA50090CG	5521831	11,58
Sportsman 550	09-14	NA50011CG*	5521783 5521802	
Sportsman Ace 570 EFI Ranger ETX Ranger 570 Ranger 570 EFI Crew RZR 570	15-16 15-16 14-16 15-16 12-16	NA50090CG	5521831	11,58
Scrambler 850 Sportsman 850 Sportsman Forest 850 Sportsman Touring 850	13-14 09-16 2015 15-16	NA50011CG*	5521783 5521802	
Ranger 900 Diesel ACE 900 EFI Ranger 900 XP Ranger Crew 900 RZR 900 RZR 4 900	11-14 2016 13-16 14-16 15-16 15-16	NA50090CG	5521831	11,58
General 1000 EPS Ranger 1000 Diesel RZR 1000 RZR XP 1000 RZR XP 1000 "4"	2016 15-16 2016 14-16 14-16	NA50090CG	5521831	11,58
Forest 1000 Scrambler 1000 Sportsman XP 1000 Sportsman Touring 1000	2015 14-16 15-16 15-16	NA50011CG* NA50011CG* NA50011CG*	5521783 5521802 5521783 5521802	

SUZUKI	Año	Referencia	Referencia Original	€
LT-Z 400 QuadSport	03-08	NA30002CG	11061-S071 11482-07G00 3446-357	13,32
LT-Z 400 QuadSport	09-14	NA30013CG	11482-07G10	11,19
LT-F 400 Eiger	02-07	NA30010CG	11482-38F10	20,39
LT-F 400 King Quad	08-15	NA30010CG	11482-38F10	20,39
LT-R 450 Quadracer	06-11	NA30005CG	11484-45G00	9,92
LT-A 450 King Quad	07-10	NA30053CG	11482-11H00	8,9
LT-A 500 King Quad	07-08	NA30053CG	11482-11H00	8,9
LT-A 500 King Quad	09-15	NA30053CG	11482-11H00	8,9
LT-A 700 King Quad	05-07	NA30015CG	11482-31G00-00	11,56
LT-A 750 King Quad	08-16	NA30015CG	11482-31G00-00	11,56

YAMAHA	Año	Referencia	Referencia Original	€
YFA 125 Breeze	89-04	NA40019CG	3FA-15451-11-00	15,71
YFM 125 Grizzly	04-13		10V-15451-01-00 3JM-15451-00-00 3JM-15451-01-00 3JM-15451-10-00 3JM-15451-11-00	10,25
YFS 200 Blaster	88-06	NA40002CG	4BD-15463-01-00	10,67
YFB 250 Timberwolf YFM 250 Bear Tracker YFM 250 Bruin YFM 250 Big Bear	92-00 99-04 05-06 07-09	NA40015CG	3GG-15461-00-00 3GG-15461-01-00 3GG-15461-02-00	13,79
YFZ 350 Banshee	87-06	NA40001CG	3GD-15461-00-00	19,23
YFM 350 Big Bear YFM 350 Warrior YFM 350 Raptor	87-98 87-04 04-13	NA40005CG	3GD-15461-00-00	19,23
YFM 400 Kodiak	93-98	NA40005CG	3GD-15461-00-00	19,23
YFZ 450	04-13	NA40009CG	5TA-15462-00-00	11,21
YFM 660 R Raptor	01-05	NA40004CG	5LP-15462-00-00	14,01
YFM 700 R Raptor	06-17	NA40012CG	1S3-15462-00-00	11,21
YFM 700 Grizzly YFM 700 Kodiak YXE 700 Wolverine	16-18 16-18 16-18	NA40025CG2	2MB-E5451-00-00	9,63

RUEDAS Y NEUMÁTICOS
MOTOR
ADMISIÓN / ESCAPE REFRIGERACIÓN
ELECTRICO
SUSPENSIÓN / DIRECCIÓN
FRENS
TRANSMISIÓN
CONTROLES Y MANDOS
CHASIS
ACCESORIOS



Filtros de aceite



A



C

ADLY	Año	Hiflo filtro	Referencia	€
200 ATV		HF185	DMP07605	2,88
220 Sentinal	07	HF185	DMP07605	2,88
300 Crossover		HF112	E10-99200	3,27
300 Crosroad		HF112	E10-99200	3,27
300 Sport		HF112	E10-99200	3,27
300 Interceptor		HF112	E10-99200	3,27
300 Sentinel		HF112	E10-99200	3,27
300 Assault		HF112	E10-99200	3,27
300 Hurricane		HF112	E10-99200	3,27
300 Utility		HF112	E10-99200	3,27
500 Hurricane		HF112	E10-99200	3,27
500 Flat LOF		HF112	E10-99200	3,27

AEON	Año	Hiflo filtro	Referencia	€
200 Quad	02-08	HF197	DMC07073	9,19
350 Cobra		HF197	DMC07073	9,19
350 Crossland		HF197	DMC07073	9,19
350 Cube		HF197	DMC07073	9,19

ARCTIC CAT	Año	Hiflo filtro	Referencia	€
250	99-05	HF132	E10-55500	3,27
300	98-05	HF132	E10-55500	3,27
350 CR	11-12	HF621	DAT07184	7,98
366	08-11	HF621	DAT07184	7,98
400	98-08	HF138	E10-55660	6,14
400 ACT	2004	HF138	E10-55660	6,14
400 Alterra	2016	HF621	DAT07184	7,98
400 CR	03-15	HF621	DAT07184	7,98
400 DVX	04-08	HF139	E10-55510	3,27
400 LE	05-07	HF138	E10-55660	6,14
400 TBX	04-06	HF138	E10-55660	6,14
400 TRV	06-07	HF138	E10-55660	6,14
400 TRV Core	13	HF621	DAT07184	7,98
400 TRV H1	09-10	HF621	DAT07184	7,98
400 VP	05-06	HF138	E10-55660	6,14
425 CR	11-12	HF621	DAT07184	7,98
450 todos	11-16	HF621	DAT07184	7,98
454	96-98	HF138	E10-55660	6,14
500	98-08	HF138	E10-55660	6,14
500	08-09	HF621	DAT07184	7,98
500	15-16	HF621	DAT07184	7,98
500 Core	13-14	HF621	DAT07184	7,98
500 LE	05-06	HF138	E10-55660	6,14
500 M4	08	HF621	DAT07184	7,98
500 TBX	04-06	HF138	E10-55660	6,14
500 TRV	04-06	HF138	E10-55660	6,14

Tipo	Equivalencia Hiflo Filtro	Ref. EMGO	Ref. BRONCO	€
A	HF112	E10-99200		2,58
A	HF113		DAT070052	2,58
A	HF116		DAT07066	3,24
A	HF123	E10-30000		2,58
A	HF132	E10-55500		2,58
C	HF138	E10-55660		5,52
A	HF139	E10-55510		2,58
A	HF141	E10-79130	DMP07611	2,58
A	HF142	E10-79120		2,58
A	HF143	E10-79110		2,58
A	HF145	E10-79100		2,58
C	HF147	E10-82250		5,52
A	HF151		DMC07200	2,58
A	HF152	E10-26966		2,58
A	HF155		DMX07010	3,57
A	HF157		DMX07013	3,64
C	HF198		DAT070631	5,52
C	HF199		DAT07087	5,52
C	HF204	E10-82240		5,52
C	HF303	E10-82230		5,52
C	HF557		DAT07180	5,52
C	HF621		DAT07184	5,52
A	HF111		DAT070131	3,48

500 TRV	08	HF621	DAT07184	7,98
500 TRV	13-15	HF621	DAT07184	7,98
500 XT	13	HF621	DAT07184	7,98
500 XR	15	HF621	DAT07184	7,98
550 todos	09-15	HF621	DAT07184	7,98
600 todos	04	HF204	E10-82240	6,62
650 H1	07-11	HF621	DAT07184	7,98
650 V-2	04-06	HF204	E10-82240	6,62
700 todos	08-15	HF621	DAT07184	7,98
1000 todos los quad	10-11	HF621	DAT07184	7,98
500 Prowler	15	HF621	DAT07184	7,98
550 Prowler	10-13	HF621	DAT07184	7,98
650 Prowler	07-09	HF621	DAT07184	7,98
700 Prowler	09-16	HF621	DAT07184	7,98
700 Wildcat	15-16	HF621	DAT07184	7,98
1000 Wildcat	13-16	HF621	DAT07184	7,98
1000 Prowler	09-13	HF621	DAT07184	7,98

CAN AM	Año	Hiflo filtro	Referencia	€
200 Rally	03-07	HF559	DMC07347	3,27
330 Outlander	04-06	HF152	E10-26966	3,82
400 Outlander	04-14	HF152	E10-26966	3,82
400 Outlander Max	07-15	HF152	E10-26966	3,82
DS450	08-15	HF560	DAT07185	3,82
450 Outlander	15-16	HF152	E10-26966	3,82
450 Outlander Max	15-16	HF152	E10-26966	3,82
500 Outlander	07-15	HF152	E10-26966	3,82
500 Outlander Max	07-15	HF152	E10-26966	3,82
500 Quest	03-04	HF556	DAT07061	6,2
500 Renegade	08-15	HF152	E10-26966	3,82
500 Traxter	99-05	HF557	DAT07180	8,09
570 Outlander	16	HF152	E10-26966	3,82
570 Outlander Max	16	HF152	E10-26966	3,82
570 Renegade	16	HF152	E10-26966	3,82
DS 650	01-06	HF152	E10-26966	3,82
650 Outlander	06-16	HF152	E10-26966	3,82
650 Outlander Max	06-15	HF152	E10-26966	3,82
650 Quest	02-04	HF556	DAT07061	6,2
650 Quest Max	04	HF556	DAT07061	6,2
650 Traxter	05	HF556	DAT07061	6,2
650 Traxter Max	05	HF556	DAT07061	6,2
800 Commander	11-16	HF152	E10-26966	3,82
800 Outlander	06-15	HF152	E10-26966	3,82
800 Outlander Max	06-15	HF152	E10-26966	3,82
800 Renegade	08-15	HF152	E10-26966	3,82
850 Outlander	16	HF152	E10-26966	3,82
850 Outlander Max	16	HF152	E10-26966	3,82



Filtros de aceite

850 Renegade	16	HF152	E10-26966	3,82
1000 Outlander	12-16	HF152	E10-26966	3,82
1000 Outlander Max	13-16	HF152	E10-26966	3,82
1000 Renegade	12-16	HF152	E10-26966	3,82
1000 Commander	11-16	HF152	E10-26966	3,82
1000 Commander Max	14-16	HF152	E10-26966	3,82
1000 Maverick	14-16	HF152	E10-26966	3,82
1000 Maverick X	14-16	HF152	E10-26966	3,82
1000 Maverick X Turbo	16	HF152	E10-26966	3,82
1000 Maverick Max X	14-16	HF152	E10-26966	3,82
1000 Maverick Max X Turbo	16	HF152	E10-26966	3,82

CF MOTO	Año	Hiflo filtro	Referencia	€
CF 500		HF682	DAT07309	6,83
700 X - Lander		HF682	DAT07309	6,83

DINLI	Año	Hiflo filtro	Referencia	€
450 DL 901	05-06	HF112	E10-99200	3,27
450 DL 901 DMX	07-08	HF112	E10-99200	3,27
450 DL 902		HF112	E10-99200	3,27
460 DL 904 DMX	08	HF112	E10-99200	3,27

GAS GAS	Año	Hiflo filtro	Referencia	€
450 Wild HP	03-07	E10-99200	HF112	

GOES	Año	Hiflo filtro	Referencia	€
450 X		HF682	DAT07309	6,83
520		HF682	DAT07309	6,83
520 Max		HF682	DAT07309	6,83
520 CUV UTX		HF682	DAT07309	6,83
625i X6 Max		HF682	DAT07309	6,83
725i S		HF682	DAT07309	6,83

HONDA	Año	Hiflo filtro	Referencia	€
TRX 250	85-92	HF112	E10-99200	3,27
TRX 300	87-01	HF112	E10-99200	3,27
TRX 300 Sportrax	93-09	HF112	E10-99200	3,27
TRX 350 Rancher	00-06	HF113	DAT070052	3,27
TRX 400 Foreman	95-02	HF113	DAT070052	3,27
TRX 400 Sportrax	99-08	HF113	DAT070052	3,27
TRX 400 Rancher	04-07	HF111	DAT070131	4,33
TRX 420 Rancher DTC	09-16	HF114	DAT07181	3,82
TRX 420 Rancher	07-16	HF113	DAT070052	3,27
TRX 450 Foreman	98-04	HF113	DAT070052	3,27
TRX 450 R	04-14	HF116	E10-99210	3,82
TRX 500 Rubicon	00-14	HF111	DAT070131	4,33
TRX 500 Rubicon	15-16	HF114	DAT07181	3,82
TRX 500 Foreman	05-16	HF113	DAT070052	3,27
TRX 650 Rincon	03-05	HF111	DAT070131	4,33
TRX 680 Rincon	06-16	HF111	DAT070131	4,33
TRX 700 XX	08-11	HF112	E10-99200	3,27

KAWASAKI	Año	Hiflo filtro	Referencia	€
KLF 220 Bayou	88-02	HF123	E10-30000	3,27
KLF 250 Bayou	03-11	HF123	E10-30000	3,27
KSF 250 Mojave	87-04	HF123	E10-30000	3,27
KEF 300 Lakota	95-03	HF123	E10-30000	3,27
KLF 300 Bayou	86-04	HF123	E10-30000	3,27
KVF 300 Prairie	99-02	HF303	E10-82230	6,41
KVF 360 Prairie	03-15	HF204	E10-82240	6,62
KFX 400	03-06	HF139	E10-55510	3,27
KLF 400 Bayou	93-98	HF303	E10-82230	6,41
KVF 400 Prairie	97-02	HF303	E10-82230	6,41
KFX 450 R	08-14	HF112	E10-99200	3,27
KVF 650 Prairie	02-03	HF204	E10-82240	6,62
KVF 650 Bute Force	05-13	HF204	E10-82240	6,62
KVF 650 Brute Force i	06-15	HF204	E10-82240	6,62
KFX 700	04-09	HF204	E10-82240	6,62

KTM - POLARIS

** DMX07010	Largo
*DMX07013	Corto

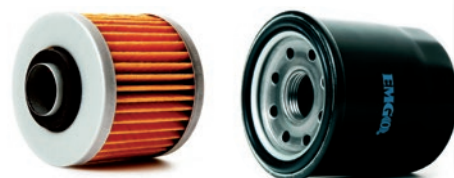

KVF 750 Brute Force	05-16	HF204	E10-82240	6,62
KAF 300 Mule 500		HF128	E10-24410	6,41
KAF 300 Mule 520		HF128	E10-24410	6,41
KAF 300 Mule 550		HF128	E10-24410	6,41
KAF 400 Mule 610	05-16	HF128	E10-24410	6,41
KAF 400 Mule 600	05-16	HF128	E10-24410	6,41
KAF 450 Mule 1000		HF303	E10-82230	6,41
KAF 540 2010		HF303	E10-82230	6,41
KAF 540 2020		HF303	E10-82230	6,41
KAF 540 2030		HF303	E10-82230	6,41
KAF 620 Mule 2500		HF128	E10-24410	6,41
KAF 620 Mule 2510		HF128	E10-24410	6,41
KAF 620 Mule 2520		HF128	E10-24410	6,41
KAF 620 Mule 3000		HF128	E10-24410	6,41
KAF 620 Mule 3010		HF128	E10-24410	6,41
KAF 620 Mule 3020		HF128	E10-24410	6,41
KAF 620 Mule 4000		HF128	E10-24410	6,41
KAF 620 Mule 4010		HF128	E10-24410	6,41
KRF 750 Teryx	08-13	HF204	E10-82240	6,62
KRT 800 Teryx 4	14-16	HF204	E10-82240	6,62
KAF 820 Mule	15-16	HF129	DAT07088	6,62
KAF 950 Mule 2510 Diesel	00-03	HF129	DAT07088	6,62
KAF 950 Mule 3010 Diesel	04-08	HF129	DAT07088	6,62
KAF 950 Mule 3010 Trans Diesel	07-11	HF129	DAT07088	6,62
KAF 950 Mule 4010 Diesel	09-15	HF129	DAT07088	6,62
KAF 950 Mule 4010 Trans Diesel	09-15	HF129	DAT07088	6,62

KTM	Año	Hiflo filtro	Referencia	€
450 SX	09-11	HF650	DMX07168	3,82
450 XC (1r Filtro de Aceite) (2n Filtro de Aceite)	08-11	HF155 HF157	DMX07010** DMX07013*	3,82 3,82
505 SX	09-12	HF650	DMX07168	3,82
525 XC (1r Filtro de Aceite) (2n Filtro de Aceite)	08-11	HF155 HF157	DMX07010** DMX07013*	3,82 3,82

KYMCO	Año	Hiflo filtro	Referencia	€
375 Maxxer	08-12	HF138	E10-55660	6,14
375 MXU	08-12	HF138	E10-55660	6,14
400 MXU	08-12	HF138	E10-55660	6,14
450 Maxxer	11-15	HF138	E10-55660	6,14
450 MXU	11-15	HF138	E10-55660	6,14
500 MXU	06-15	HF147	E10-82250	6,51
500 UXV	08-15	HF147	E10-82250	6,51
550 MXU	11-12	HF147	E10-82250	6,51
700 MXU	13	HF147	E10-82250	6,51

POLARIS	Año	Hiflo filtro	Referencia	€
200 Phoenix	05-15	HF197	DMC07073	9,19
200 Sawtooth	06-07	HF197	DMC07073	9,19
300 Hawkeye	07-11	HF303	E10-82230	6,41
300 Sportsman	08-10	HF303	E10-82230	6,41
325 Ace	15-16	HF116	E10-99210	3,82
325 Hawkeye	15	HF303	E10-82230	6,41
325 Magnum	00-02	HF303	E10-82230	6,41
325 Ranger	15	HF116	E10-99210	3,82
325 Sportsman	14-15	HF116	E10-99210	3,82
325 Trail Boss	00-02	HF303	E10-82230	6,41
325 Xpedition	00-02	HF303	E10-82230	6,41
330 ATP	04-05	HF303	E10-82230	6,41
330 Hawkeye	06	HF303	E10-82230	6,41
330 Magnum	03-06	HF303	E10-82230	6,41
330 Trail Blazer	08-11	HF303	E10-82230	6,41
330 Trail Blazer	12-13	HF199	DAT07087	6,83
330 Trail Boss	03-11	HF303	E10-82230	6,41
330 Trail Boss	12-13	HF199	DAT07087	6,83
335 Sportsman	99-01	HF303	E10-82230	6,41
335 Worker	99	HF303	E10-82230	6,41
400 Hawkeye	11	HF303	E10-82230	6,41

RUEDAS Y NEUMÁTICOS

MOTOR

ADMISIÓN / ESCAPE
REFRIGERACIÓN

ELECTRICO

SUSPENSIÓN / DIRECCIÓN

FRENOS

TRANSMISIÓN

CONTROLES Y MANDOS

CHASIS

ACCESORIOS

KTM - POLARIS

** DMX07010	Largo
*DMX07013	Corto

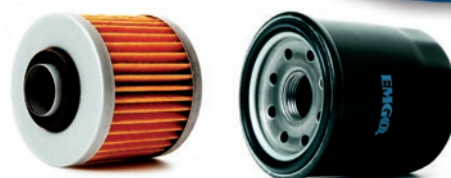

400 Hawkeye	12-14	HF199	DAT07087	6,83
400 Sportsman	01-05	HF303	E10-82230	6,41
400 Sportsman	08-11	HF303	E10-82230	6,41
400 Sportsman	12-14	HF199	DAT07087	6,83
400 Xplorer	96-01	HF303	E10-82230	6,41
425 Magnum	95-98	HF303	E10-82230	6,41
425 Xpedition	00-02	HF303	E10-82230	6,41
450 Outlaw (1r Filtro) (2n Filtro)	08-11	HF155 HF157	DMX07010** DMX07013*	3,82 3,82
450 Sportsman	06-07	HF303	E10-82230	6,41
500 ATP	04-05	HF303	E10-82230	6,41
500 Big Boss	98-99	HF303	E10-82230	6,41
500 Magnum	00-02	HF303	E10-82230	6,41
500 Outlaw	06-07	HF112	E10-99200	3,27
500 Predator	03-07	HF112	E10-99200	3,27
500 Ranger	06-13	HF303	E10-82230	6,41
500 Scrambler	96-11	HF303	E10-82230	6,41
500 Scrambler	12	HF199	DAT07087	6,83
500 Sportsman	00-11	HF303	E10-82230	6,41
500 Sportsman	12-14	HF199	DAT07087	6,83
500 Worker	99-01	HF303	E10-82230	6,41
500 Xplorer	97	HF303	E10-82230	6,41
525 Outlaw (1r Filtro) (2n Filtro)	07-11	HF155 HF157	DMX07010** DMX07013*	3,82 3,82
550 Sportsman	09-14	HF199	DAT07087	6,83
570 Ace	16	HF198	DAT07062	7,88
570 RZR	12-16	HF198	DAT07062	7,88
570 Sportsman	14-16	HF199	DAT07087	6,83
600 Sportsman	03	HF196	DAT07063	8,33
600 Sportsman	04-06	HF198	DAT07062	7,88
700 Ranger	07-09	HF198	DAT07062	7,88
700 Sportsman Twin	02-03	HF196	DAT07063	8,33
700 Sportsman Twin	04-08	HF198	DAT07062	7,88
800 Ranger	10-13	HF198	DAT07062	7,88
800 RZR	08-16	HF198	DAT07062	7,88
800 RZR S	09-15	HF198	DAT07062	7,88
800 RZR 4	12-13	HF198	DAT07062	7,88
800 Sportsman	05-14	HF198	DAT07062	7,88
850 Scrambler	16	HF199	DAT07087	6,83
850 Sportsman	09-16	HF199	DAT07087	6,83
900 Ace	16	HF198	DAT07062	7,88
900 Ranger XP	13	HF198	DAT07062	7,88
900 RZR XP	11-16	HF199	DAT07087	6,83
900 RZR XP 4	13	HF198	DAT07062	7,88
1000 General	16-17	HF198	DAT07062	7,88
1000 RZR	14-17	HF198	DAT07062	7,88
1000 RZR Turbo	16-17	HF198	DAT07062	7,88
1000 RZR 4	14-17	HF198	DAT07062	7,88
1000 Scrambler	14-17	HF199	DAT07087	6,83
1000 Sportsman	15-17	HF199	DAT07087	6,83

SUZUKI

Año	Hiflo filtro	Referencia	€	
LT-Z 90 QuadSport	07-09	HF131	DMP07520	3,82
LT-F 160 Quadrunner	91-04	HF132	E10-55500	3,27
LT-F 250 Ozark	03-16	HF132	E10-55500	3,27
LT-F 250 Quadrunner	88-02	HF132	E10-55500	3,27
LT-Z 250 QuadSport	04-09	HF132	E10-55500	3,27
LT-F 300 King Quad	00-02	HF132	E10-55500	3,27
LT-A 400 King Quad	09-16	HF138	E10-55660	6,14
LT-F 400 King Quad	09-16	HF138	E10-55660	6,14
LT-A 400 Eiger	02-07	HF138	E10-55660	6,14
LT-F 400 Eiger	02-07	HF138	E10-55660	6,14
LT-Z 400 QuadSport	03-16	HF139	E10-55510	3,27
LT-A 450 King Quad	07-10	HF138	E10-55660	6,14
LT-R 450 QuadRacer	06-09	HF139	E10-55510	3,27
LT-A 500 F Quadrunner	98-02	HF138	E10-55660	6,14
LT-F 500 F Quadrunner	98-02	HF138	E10-55660	6,14
LT-A 500 King Quad	09-16	HF138	E10-55660	6,14
LT-F 500 Vinson	02-06	HF138	E10-55660	6,14
LT-A 500 Vinson	03-07	HF138	E10-55660	6,14
LT-A 700 King Quad	05-08	HF138	E10-55660	6,14
LT-V 700 Twin Peaks	04-06	HF204	E10-82240	6,62
LT-A 750 King Quad	08-16	HF138	E10-55660	6,14

YAMAHA

Año	Hiflo filtro	Referencia	€	
YFM 250 Bear Tracker	99-04	HF143	E10-79110	3,27
YFM 250 Big Bear	07-08	HF143	E10-79110	3,27
YFM 250 Bruin	05-06	HF143	E10-79110	3,27
YFM 250 Raptor	08-13	HF140	DAT07132	3,27
YFB 250 Timberwolf	92-00	HF143	E10-79110	3,27
YFM 350 Big Bear	87-99	HF142	E10-79120	3,27
YFM 350 Bruin	04-06	HF303	E10-82230	6,41
YFM 350 Grizzly	07-17	HF204	E10-82240	6,62
YFM 350 Grizzly IRS	07-11	HF204	E10-82240	6,62
YFM 350 Raptor	04-13	HF142	E10-79120	3,27
YFM 350 Warrior	87-04	HF142	E10-79120	3,27
YFM 350 Wolverine semi	96-05	HF142	E10-79120	3,27
YFM 350 Wolverine	06-09	HF204	E10-82240	6,62
YFM 400 Big Bear	93-06	HF142	E10-79120	3,27
YFM 400 Big Bear IRS	07-12	HF142	E10-79120	3,27
YFM 400 Grizzly	07	HF204	E10-82240	6,62
YFM 400 Kodiak	94-99	HF142	E10-79120	3,27
YFM 400 Kodiak Automatic	00-06	HF303	E10-82230	6,41
YFM 450 Grizzly	07-17	HF204	E10-82240	6,62
YFM 450 Kodiak	03-06	HF303	E10-82230	6,41
YFM 450 Wolverine	06	HF303	E10-82230	6,41
YFM 450 Wolverine	07-10	HF 204	E10-82240	6,62
YFZ 450	04-06	HF141	DAT07132	3,27
YFZ 450	07-13	HF140	DAT07132	3,27
YFZ 450 R	09-17	HF140	DAT07132	3,27
YXR 450 Rhino	06-09	HF303	E10-82230	6,41
YFM 550 Grizzly	09-14	HF204	E10-82240	6,62
YFM 600 Grizzly	98-01	HF145	E10-79100	3,82
YFM 660 Raptor	01-05	HF147	E10-82250	6,51
YFM 660 Grizzly	02-06	HF303	E10-82230	6,41
YFM 660 Grizzly	07-08	HF204	E10-82240	6,62
YXR 660 Rhino	04-06	HF303	E10-82230	6,41
YFM 700 Grizzly	07-15	HF204	E10-82240	6,62
YFM 700 Grizzly	16-17	HF147	E10-82250	6,51
YFM 700 Kodiak	16-17	HF147	E10-82250	6,51
YFM 700 Raptor	06-17	HF145	E10-79100	3,82
YXE 700 Wolverine	16-17	HF204	E10-82240	6,62
YXM 700 Viking	15-17	HF204	E10-82240	6,62
YXR 700 Rhino	08-13	HF204	E10-82240	6,62
YXZ 1000 R	16-17	HF204	E10-82240	6,62

ADMISIÓN / ESCAPE ***REFRIGERACIÓN***

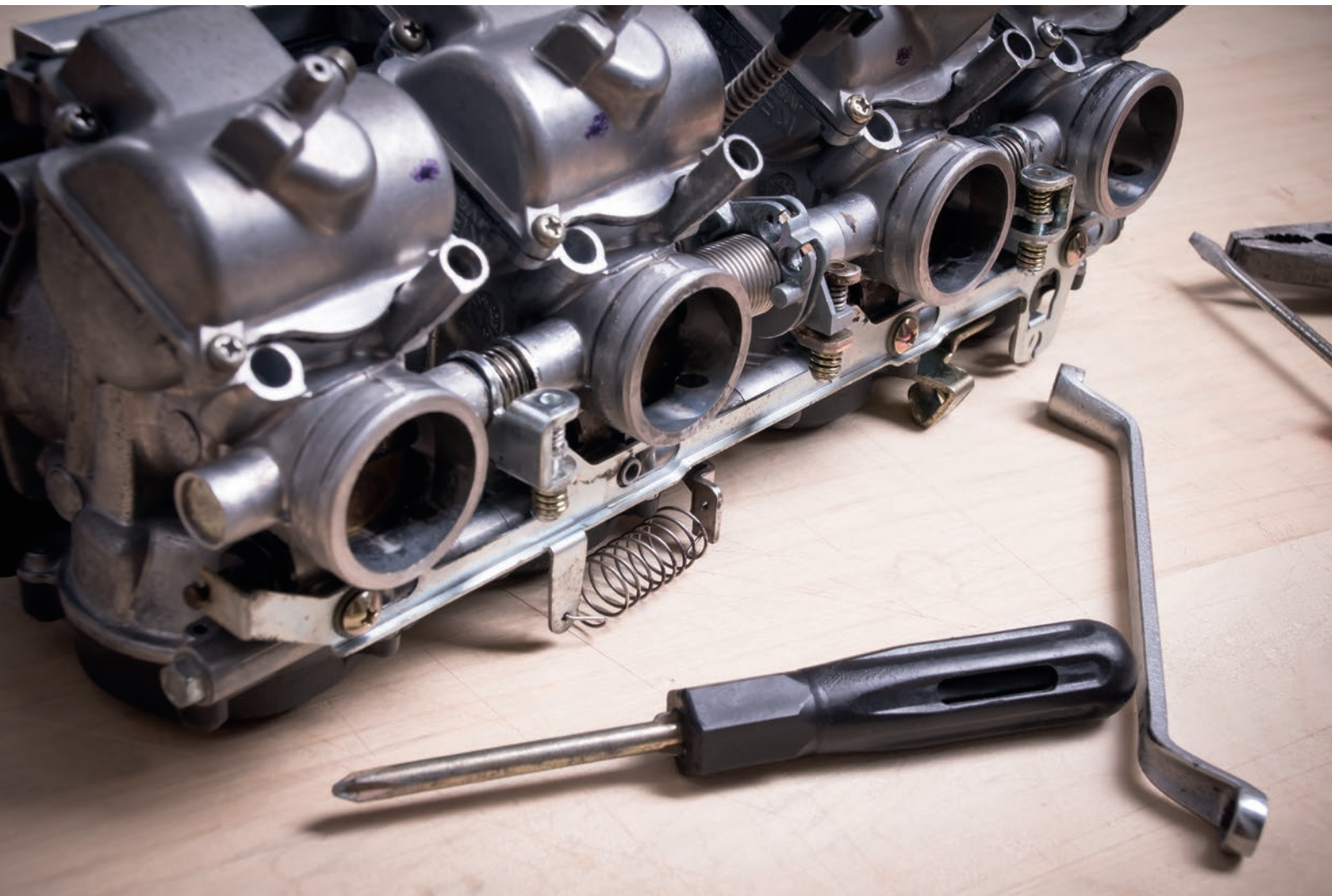

ADMISIÓN / ESCAPE / REFRIGERACIÓN



Chiclés carburador

€
5

Modelo Mikuni SJ

Referencia	Medida	Referencia	Medida	Referencia	Medida	Referencia	Medida
DSJ0725	72,5	DSJ0975	97,5	DSJ1225	122,5	DSJ1475	147,5
DSJ0750	75	DSJ1000	100	DSJ1250	125	DSJ1500	150
DSJ0775	77,5	DSJ1025	102,5	DSJ1275	127,5	DSJ1525	152,5
DSJ0800	80	DSJ1050	105	DSJ1300	130	DSJ1550	155
DSJ0825	82,5	DSJ1075	107,5	DSJ1325	132,5	DSJ1575	157,5
DSJ0850	85	DSJ1100	110	DSJ1350	135	DSJ1600	160
DSJ0875	87,5	DSJ1125	112,5	DSJ1375	137,5	DSJ1700	170
DSJ0900	90	DSJ1150	115	DSJ1400	140		
DSJ0925	92,5	DSJ1175	117,5	DSJ1425	142,5		
DSJ0950	95	DSJ1200	120	DSJ1450	145		

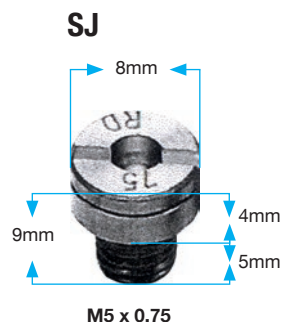

Modelo Mikuni HJ

Referencia	Medida	Referencia	Medida	Referencia	Medida	Referencia	Medida
DHJ0700	70	DHJ1750	175	DHJ3300	330	DHJ5100	510
DHJ0800	80	DHJ1800	180	DHJ3400	340	DHJ5200	520
DHJ0900	90	DHJ1850	185	DHJ3500	350	DHJ5300	530
DHJ1000	100	DHJ1900	190	DHJ3600	360	DHJ5400	540
DHJ1050	105	DHJ1950	195	DHJ3700	370	DHJ5500	550
DHJ1100	110	DHJ2000	200	DHJ3800	380	DHJ5600	560
DHJ1150	115	DHJ2100	210	DHJ3900	390	DHJ5700	570
DHJ1200	120	DHJ2200	220	DHJ4000	400	DHJ5800	580
DHJ1250	125	DHJ2300	230	DHJ4100	410	DHJ5900	590
DHJ1300	130	DHJ2400	240	DHJ4200	420	DHJ6000	600
DHJ1350	135	DHJ2500	250	DHJ4300	430	DHJ6100	610
DHJ1400	140	DHJ2600	260	DHJ4400	440	DHJ6200	620
DHJ1450	145	DHJ2700	270	DHJ4500	450	DHJ6300	630
DHJ1500	150	DHJ2800	280	DHJ4600	460	DHJ6400	640
DHJ1550	155	DHJ2900	290	DHJ4700	470	DHJ6500	650
DHJ1600	160	DHJ3000	300	DHJ4800	480	DHJ6600	660
DHJ1650	165	DHJ3100	310	DHJ4900	490	DHJ6700	670
DHJ1700	170	DHJ3200	320	DHJ5000	500	DHJ6800	680

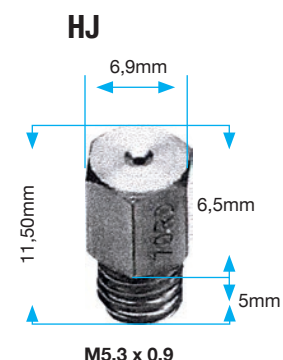

Modelo Keihin KJ

Referencia	Medida	Referencia	Medida	Referencia	Medida	Referencia	Medida
DKJ0725	72,5	DKJ0975	97,5	DKJ1225	122,5	DKJ1475	147,5
DKJ0750	75	DKJ1000	100	DKJ1250	125	DKJ1500	150
DKJ0775	77,5	DKJ1025	102,5	DKJ1275	127,5	DKJ1525	152,5
DKJ0800	80	DKJ1050	105	DKJ1300	130	DKJ1550	155
DKJ0825	82,5	DKJ1075	107,5	DKJ1325	132,5	DKJ1575	157,5
DKJ0850	85	DKJ1100	110	DKJ1350	135	DKJ1600	160
DKJ0875	87,5	DKJ1125	112,5	DKJ1375	137,5	DKJ1650	165
DKJ0900	90	DKJ1150	115	DKJ1400	140	DKJ1700	170
DKJ0925	92,5	DKJ1175	117,5	DKJ1425	142,5	DKJ1900	190
DKJ0950	95	DKJ1200	120	DKJ1450	145		

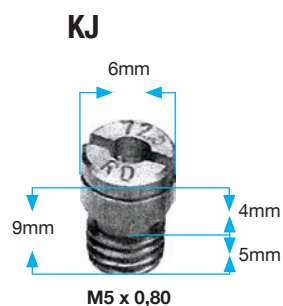

Modelo Keihin CR

Referencia	Medida	Referencia	Medida	Referencia	Medida	Referencia	Medida
DCR0800	80	DCR1200	120	DCR1600	160	DCR2000	200
DCR0820	82	DCR1220	122	DCR1620	162	DCR2020	202
DCR0850	85	DCR1250	125	DCR1650	165	DCR2050	205
DCR0880	88	DCR1280	128	DCR1680	168	DCR2080	208
DCR0900	90	DCR1300	130	DCR1700	170	DCR2100	210
DCR0920	92	DCR1320	132	DCR1720	172	DCR2120	212
DCR0950	95	DCR1350	135	DCR1750	175	DCR2150	215
DCR0980	98	DCR1380	138	DCR1780	178	DCR2180	218
DCR1000	100	DCR1400	140	DCR1800	180	DCR2200	220
DCR1020	102	DCR1420	142	DCR1820	182	DCR2220	222
DCR1050	105	DCR1450	145	DCR1850	185	DCR2250	225
DCR1080	108	DCR1480	148	DCR1880	188	DCR2280	228
DCR1100	110	DCR1500	150	DCR1900	190	DCR2300	230
DCR1120	112	DCR1520	152	DCR1920	192	DCR2320	232
DCR1150	115	DCR1550	155	DCR1950	195	DCR2350	235
DCR1180	118	DCR1580	158	DCR1980	198		

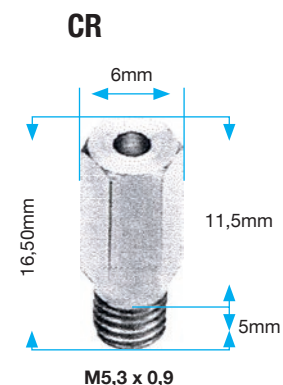



Válvulas aguja de carburador

Las fotografías son a tamaño real.



Referencia	€	Referencia	€	Referencia	€	Referencia	€
DAT07117	16,20	DAT07118	16,20	DAT07138	16,20	DAT07139	16,20



Referencia	€	Referencia	€	Referencia	€
DAT07140	16,20	DAT07141	16,20	DAT07164	16,20

4PLAY Kit de reparación carburador

HONDA	Año	Referencia	€
TRX 250 Sportrax	01-05	DAU07161	23,81
TRX 250 Rencon	97-05	DAU07161	23,81
TRX 250 Recon	06-14	DAU07403	23,62
TRX 300 Sportrax	93-08	DAU07412	25,48
TRX 350 Rancher	00-03	DAU07208	26,04
TRX 350 Rancher	04-06	DAU07144	23,81
TRX 400 Sportrax	99-04	DAU07457	26,64
TRX 400 Sportrax	05-14	DAU07458	26,64
TRX 400 Rancher	04-07	DAU07401	25,48
TRX 450 Foreman	98-03	DAU07148	23,25
TRX 450 Sportrax	04-05	DAU07452	26,64
TRX 450 Sportrax	06-12	DAU07453	28,92
TRX 500 Rubicon	01-04	DAU07400	25,48
TRX 500 Foreman	05-12	DAU07402	25,48
TRX 650 Rincon	03-05	DAU07442	26,64

KAWASAKI	Año	Referencia	€
KLF 220 Bayou	88-98	DAU07209	18,60
KLF 300 Bayou	89-95	DAU07217	18,85
KVF 300 Prairie	99-02	DAU07418	18,85
KVF 360 Prairie	03-07	DAU07406	25,48
KFX 400	03-06	DAU07462	28,92
KVF 650 Prairie	02-04	DAU07422	49,85
KVF 650 Brute Force	04-13	DAU07422	49,85
KFX 700	04-09	DAU07446	47,28
KVF 700 Prairie	04-06	DAU07422	49,85
KVF 750 Brute force	05-07	DAU07425	37,62
MULE 3010	todos	DAU07149	23,81

POLARIS	Año	Referencia	€
250 Trail Blazer	90-95	DAU07415	25,48
250 Trail Blazer	96-00	DAU07420	25,48
250 Trail Boss	88-99	DAU07415	25,48
250 Xplorer	2000	DAU07420	25,48
300	94-95	DAU07416	25,48
300 Xplorer	96-99	DAU07416	25,48
300 Xpress	96-99	DAU07416	25,48
325 Magnum	00-02	DAU07428	
325 Trail Boss	00-01	DAU07428	
330 Magnum	03-05	DAU07441	
330 Trail Boss	03-05	DAU07441	
330 Trail Boss	06-13	DAU07427	19,40
330 Trail Blazer	08-13	DAU07427	19,40
330 Magnum	2006	DAU07427	19,40
400 Hawkeye	11-14	DAU07427	19,40
400 Scramler	97-01	DAU07433	
400 Sportsman	01-02	DAU07432	
400 Sportsman	03-04	DAU07440	
400 Sportsman HO	08-14	DAU07427	
400 L Sport	94-95	DAU07417	25,48
400 Xplorer	94-95	DAU07417	25,48
400 Xplorer	97-02	DAU07421	25,48

DAU07409



450 Sportsman	06-07	DAU07427	19,40
500 Predator	03-07		
500 Scrambler	98-02	DAU07410	25,48
500 Scrambler	03-09	DAU07411	25,48
500 Sportsman	03-11	DAU07411	25,48
700 Sportsman	02-06	DAU07436	28,92

SUZUKI	Año	Referencia	€
LT-F 250 Quadrunner	90-96	DAU07223	18,85
LT-A 250 Ozark	02-14	DAU07409	25,48
LT-Z 250	04-09	DAU07445	28,50
LT-A 400 Eiger	03-07	DAU07408	26,04
LT-Z 400	03-08	DAU07462	28,92
LT-F 500 Quadrunner	98-02	DAU07419	28,46
LT-A 500 Vinson	02-07	DAU07434	24,17
LT-F 500 Vinson	03-07	DAU07434	24,17

YAMAHA	Año	Referencia	€
YFM 80 Badger	92-01	DAU07147	23,25
YFM 80 Raptor	02-04	DAU07147	23,25
YFS 200 Blaster	88-06	DAU07461	24,06
YFB 250 Timberwolf	92-98	DAU07222	18,18
YFM 250 Bear Tracker	99-04	DAU07146	23,25
YFM 350 Grizzly	07-11	DAU07429	24,06
YFM 350 Big Bear	89-92	DAU072071	18,23
YFM 350 Big Bear	93-98	DAU07413	25,48
YFM 350 Raptor	04-13	DAU07443	28,92
YFM 350 Warrior	88-04	DAU07413	25,48
YFM 350 Wolverine	1995	DAU07413	25,48
YFM 350 Wolverine	06-09	DAU07429	24,06
YFZ 350 Banshee	98-06	DAU07463	24,06
YFM 400 Kodiak (semi)	93-98	DAU07413	25,48
YFM 400 Kodiak	00-04	DAU07145	23,81
YFM 400 Big Bear PRO	00-06	DAU07404	25,48
YFM 450 Grizzly	07-14	DAU07426	26,64
YFM 450 Kodiak	03-06	DAU07431	26,64
YFM 450 Wolverine	2006	DAU07431	26,64
YFM 450 Wolverine	07-10	DAU07426	26,64
YFZ 450	04-09	DAU07451	26,62
YFM 600 Grizzly	98-01	DAU07162	23,81
YFM 660 Grizzly	02-08	DAU07405	26,60
YFM 660 Raptor	01-05	DAU07466	49,98
YXR 660 Rhino	04-07	DAU07465	26,62

ADMISIÓN / ESCAPE / REFRIGERACIÓN



Tornillo regulación aire de aluminio

Tornillo para la mezcla de aire y gasolina, de rápido acceso.
Para carburadores KEIHIN modelo FCR.
Fabricado en aluminio AL6061 T6.

€
14,84



Referencia	Descripción	€
DMX07014RD	Rojo	14,84
DMX07014GN	Verde	14,84
DMX07014GL	Oro	14,84
DMX07014BU	Azul	14,84
DMX07014BK	Negro	14,84
DMX07014TI	Titanio	14,84
DMX07014OR	Naranja	14,84

BRONCO Tornillo regulación aire de latón

Referencia	Descripción	€
DAT07700	1 und. YFZ 450 04-09	11,55
DAT07701	2 und. YFM 660 Raptor 01-05	18,96



BRONCO Grifos gasolina

SUZUKI	Año	Referencia	€
LT-Z 400	03-07	DAT07580	30,49
LT-A 400 Eiger	02-07	DAT07581	30,49
LT-F 400 Eiger	02-07	DAT07581	30,49
LT-A 500 Vinson	02-07	DAT07583	30,49
LT-F 500 Vinson	03-07	DAT07583	30,49

YAMAHA	Año	Referencia	€
YFM 660 Raptor	01-05	DAT07582	21,56



BRONCO Tobera admisión

Referencia	Descripción	€
DAT07094	Sportsman 600	35,79
DAT07094	Sportsman 700	35,79
DAT07122	Warrior / Raptor 350	39,41



Referencia	Descripción	€
DAT07574	YAMAHA - A: Ø 7mm, B: Anclaje Ø 6,6mm a 34mm, C: Tubo 38/29,5mm / 66mm	14,40
DAT07575	YAMAHA - A: Ø 8mm, B: Anclaje Ø 6,6mm a 34mm, C: Tubo 35,8/30mm / 66mm	14,40



Extractor de chiclés

Referencia	€
DUP12069	12,32



Destornillador curvo

Referencia	€
DUP12840	85,82



Galgas Chiclés

Referencia	Medidas (mm)	€
DUP12171	Desde 0,45 - 1,5	10,80
DUP121711	Desde 1,5 a 3,0	10,80



XPEED Tapón gasolina de aluminio

Tapón de aluminio con válvula.
Embellce tu Quad.



Referencia	Descripción	€
R1762011	* Todos los HONDA (excepto Rincón), SUZUKI , KAWASAKY (excepto KFX 450 R) y los YAMAHA (excepto Breeze y Raptor 700)	24,29
R1762071	** Todos los HONDA (excepto Rincón), SUZUKI , KAWASAKY (excepto KFX 450 R) y los YAMAHA (excepto Breeze y Raptor 700)	28,52
R1762012	* YAMAHA Raptor 700 / POLARIS	21,84
R1762072	* YAMAHA Raptor 700 / POLARIS	24,29



€
6,09

XPEED Válvula tapón gasolina

Referencia	Descripción
R250BK	Tubo desvaporador Negro
DMC07371BL	Tubo desvaporador Azul
DMC07371R	Tubo desvaporador Rojo
R250GR	Tubo desvaporador Dorado
DMC07371TI	Tubo desvaporador Titanio

XPEED Tapón gasolina con llave

Protege tu depósito de hurtos y gamberradas.



Referencia	Descripción	€
GM9531	* YAMAHA Raptor 700 / POLARIS	18,04



Conector rápido gasolina

Referencia	Descripción	€
DAT07040	Tubo Ø 6mm	8,23
DAT070401	Tubo Ø 8mm	9,17



Filtro de gasolina

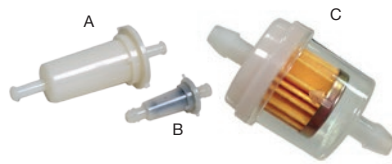

Referencia	Imagen	Descripción	€
E14-34441	A	F. Gasolina Grande Ø 6 mm.	1,12
E14-34421	B	F. Gasolina Pequeño Ø 6 mm.	0,79
DUP07101	C	F. Gasolina para tubo Ø 6 mm.	1,20
DUP071011	C	F. Gasolina para tubo Ø 8 mm.	1,50

Tubo gasolina NBR 5m

Referencia	Descripción	€
DMC07043	Tubo Ø 4,8 mm	11,90
DMC070431	Tubo Ø 6,3 mm	11,90
DMC070432	Tubo Ø 8 mm	22,20



Brida tubo gasolina 10 und.

Referencia	Descripción	€
DSM07046	Ø 8,5 mm	2,40
DSM07045	Ø 9,8 mm	3,10
DSM07049	Ø 11,6 mm	3,60
D07238A	Ø 18 mm	4,40



Limpiador de chiclés

Referencia	€
DMP12327	7,20



ADMISIÓN / ESCAPE / REFRIGERACIÓN

EMIGO
BRONCO

Filtros de aire



ARCTIC CAT	Año	Referencia	€
650	08-10	DAT07310	13,80
700	09-14	DAT07310	13,80
1000	09-13	DAT07311	19,70
Prowler	09-14	DAT07310	13,80

CAN AM	Año	Referencia	€
Outlander 330	04-05	DAT07284	24,10
Outlander 400 Carburador	03-08	DAT07284	24,10
Outlander 400 Inyección	08-14	DAT07296	22,30
DS 450	08-12	DAT07285	26,60
Outlander 500	07-09	DAT07283	35,60
Outlander 500	13-14	DAT07298	32,30
Renegade 500	13-14	DAT07298	32,30
DS 650	00-07	DAT07285	26,60
Outlander 650	06-09	DAT07283	35,60
Outlander 650	13-14	DAT07298	32,30
Commander 800	11-17	DAT07322	23,70
Outlander 800	06-08	DAT07283	35,60
Outlander 800	13-14	DAT07298	32,30
Renegade 800	07-08	DAT07283	35,60
Renegade 800	12-14	DAT07298	32,30
Commander 1000	11-17	DAT07322	23,70
Maverick 1000	13-17	DAT07322	23,70
Outlander 1000	13-14	DAT07298	32,30
Renegade 1000	12-14	DAT07298	32,30

HONDA	Año	Referencia	€
TRX 250 EX Sportrax	01-11	DAT07074	22,30
TRX 250 Recon	97-12	DAT07074	22,30
TRX 300 FW	89-00	E12-90620	14,80
TRX 300 EX Sportrax	93-12	DAT07251	19,20
TRX 350 Rancher	00-06	E12-90620	14,80
TRX 400 Sportrax	99-11	DAT07077	27,25
TRX 400 Foreman	95-03	DAT07252	22,92
TRX 400 Rancher	04-07	DAT07252	22,92
TRX 420 Rancher	07-14	DAT07089	15,60
TRX 450 Foreman	98-03	DAT07252	22,92
TRX 450 R	06-14	DAT07254	26,40
TRX 500 Rubicon	01-15	DAT07077	27,25
TRX 650 Rincon	03-05	DAT07077	27,25
TRX 680 Rincon	06-16	DAT07077	27,25

KAWASAKI	Año	Referencia	€
KLF 220 Bayou	88-98	DAT07009	7,50
KLF 220 Bayou	99-02	DAT07009	7,50
KLF 250 Bayou	03-11	DAT07009	7,50
KSF 250 Mojave	88-04	DAT07258	8,10
KEF 300 Lakota	95-03	DAT07258	8,10
KLF 300 Bayou	88-04	DAT07009	7,50
KVF 300 Prairie	99-02	DAT07009	7,50
KFX 400	03-06	DAT07270	12,60
KLF 400 Bayou	93-99	DAT07009	7,50
KVF 400 Prairie	98-02	DAT07009	7,50
KVF 650 Brute Force	05-13	DAT07262	16,80
KVF 650i Brute Force	06-13	DAT07263	11,70
KVF 650 Prairie	2003	DAT07262	16,80
KFX 700 V-Force	04-09	DAT07262	16,80
KVF 700 Prairie	04-06	DAT07262	16,80
KVF 750i Brute Force	05-16	DAT07263	11,70

POLARIS	Año	Referencia	€
200 Phoenix	05-14	DAT07264	28,30
200 Sawtooth	06-07	DAT07264	28,30
250 Trail Blazer	90-06	DAT07264	28,30
250 Trail Boss	88-02	DAT07264	28,30
300	94-95	DAT07264	28,30
300 Hawkeye	06-11	DAT07264	28,30
300 Sportsman	08-10	DAT07264	28,30
325 Magnum	00-01	DAT07043	22,80
325 Magnum	2002	DAT07265	38,80
325 Trail Boss	2001	DAT07265	38,80
325 Xpedition	00-02	DAT07043	22,80
330 Magnum	03-06	DAT07265	38,80
330 Trail Blazer	08-13	DAT07043	22,80
330 Trail Boss	03-09	DAT07265	38,80
330 Trail Boss	10-13	DAT07043	22,80
335 Sportsman	99-00	DAT07043	22,80
335 Worker	1999	DAT07043	22,80
400 Hawkeye	11-12	DAT07043	22,80
400 Scrambler	95-02	DAT07007	12,56
400 L Sport	94-99	DAT07007	12,56
400 Sportsman	01-14	DAT07043	22,80
400 Trail Blazer	2003	DAT07007	12,56
400 Xplorer	99-00	DAT07007	12,56
400 Xplorer	01-02	DAT07264	28,30
400 Xpress	96-97	DAT07007	12,56
425 Xpedition	00-02	DAT07043	22,80
450 Sportsman	06-07	DAT07043	22,80
500 Magnum	99-03	DAT07043	22,80
500 Ranger	06-12	DAT07293	33,40
500 Scrambler	97-12	DAT07043	22,80
500 Sportsman	96-14	DAT07043	22,80
500 Worker	2001	DAT07043	22,80
500 Xplorer	1997	DAT07043	22,80
550 Sportsman	09-14	DAT07043	22,80
600 Sportsman	03-05	DAT07043	22,80
700 Ranger	06-09	DAT07293	33,40
700 Sportsman	03-07	DAT07043	22,80
800 Ranger	11-14	DAT07312	25,50
800 RZR	08-14	DAT07312	25,50
800 Sportsman	05-14	DAT07043	22,80
850 Sportsman	09-14	DAT07043	22,80
900 Ranger XP	13-16	DAT07315	26,40
1000 Ranger Diesel	15-16	DAT07315	26,40

SUZUKI	Año	Referencia	€
LT-F 160 Quadrunner	89-04	DAT07268	12,90
LT-F 250 Ozark	02-12	DAT07269	11,10
LT-Z 250 Quadsport	04-09	DAT07269	11,10
LT-A 400 Eiger	02-07	DAT07270	13,80
LT-A 400 King Quad	08-12	DAT07270	13,80
LT-F 400 Eiger	02-07	DAT07270	13,80
LT-F 400 King Quad	08-12	DAT07270	13,80
LT-Z 400 Quadsport	03-14	DAT07270	13,80
LT-A 450i King Quad	07-11	DAT072721	38,70
LT-A 500 King Quad	09-15	DAT072721	38,70
LT-A 500 Quadrunner	00-01	DAT07271	16,10
LT-A 500 Vinson	02-07	DAT07270	13,80
LT-F 500 Vinson	04-07	DAT07270	13,80
LT-F 500 Quadrunner	98-02	DAT07271	16,10
LT-A 700 King Quad	05-07	DAT072721	38,70
LT-V 700 Twin Peaks	04-05	DAT07262	17,80
LT-A 750i King Quad	08-15	DAT072721	38,70



Filtros de aire



YAMAHA	Año	Referencia	€
YFM 50 Raptor	06-08	DAT07274	7,20
YFM 80 Badged	92-01	DAT07274	7,20
YFM 80 Grizzly	05-08	DAT07274	7,20
YFM 80 Raptor	02-08	DAT07274	7,20
YFM 90 Raptor	09-12	DAT07274	7,20
YFM 100 Champ	87-91	DAT07274	7,20
YFB 250 Timberwolf	92-00	DAT07030	10,30
YFM 250 Bear Tracker	99-04	DAT07275	25,40
YFM 250 Big Bear	07-08	DAT07275	25,40
YFM 250 Bruin	05-06	DAT07275	25,40
YFM 350 Big Bear	87-99	DAT07008	11,89
YFM 350 Bruin	04-06	DAT07276	10,90
YFM 350 Grizzly	07-15	DAT07276	10,90
YFM 350 Grizzly IRS	07-11	DAT07276	10,90
YFM 350 Raptor	04-13	DAT07008	11,89
YFM 350 Warrior	87-04	DAT07008	11,89
YFM 350 Wolverine semi.	95-05	DAT07008	11,89
YFM 350 Wolverine	06-09	DAT07276	10,90

YFZ 350 Banshee	87-06	DAT07042	10,15
YFM 400 Big Bear PRO	00-06	DAT07275	25,40
YFM 400 Big Bear IRS	07-12	DAT07276	10,90
YFM 400 Grizzly IRS	2007	DAT07276	10,90
YFM 400 Kodiak auto.	00-06	DAT07276	10,90
YFM 400 Kodiak semi.	93-99	DAT07030	10,30
YFM 450 Grizzly	07-15	DAT07276	10,90
YFM 450 Kodiak	04-06	DAT07276	10,90
YXR 450 Rhino	06-09	E12-95824	10,52
YFM 450 Wolverine	06-11	DAT07276	10,90
YFZ 450 (utilizar adaptador R1734030)	04-09	DAT07254	26,40
YFZ 450 R (utilizar adaptador R1734030)	09-15	DAT07254	26,40
YFM 550 Grizzly	09-15	DAT07159	11,90
YFM 600 Grizzly	98-01	DAT07008	11,89
YFM 660 Grizzly	02-08	DAT07008	11,89
YFM 660 Raptor	01-05	DAT07324	12,86
YXR 660 Rhino	03-07	E12-95824	10,52
YFM 700 Grizzly	07-15	DAT07159	11,90
YFM 700 Grizzly	16-17	DAT07323	11,80
YFM 700 Kodiak	16-17	DAT07323	11,80
YFM 700 Raptor	06-17	DAT07093	12,31



Filtro algodón



Filtro de espuma

XPEED Filtros de potencia

Mejora el rendimiento del vehículo y aumenta la protección del carburador y del motor.

* Kit completo consta de filtro algodón, adaptador, pantalla.

** Filtro de aire de algodón con pantalla protectora de regalo.

	*KIT COMPLETO		**FILTRO ALGODÓN		ADAPTADOR		FILTRO ESPUMA		
	Año	Referencia	€	Referencia	€	Referencia	€	Referencia	€
HONDA									
TRX 450R	04-05	R1730010	75,90	R1732010	60,39	R1734010	5,40	R1736010	12,48
TRX 450R	06-09	R1730011	75,90	R1732030	58,50	R1734011	10,15	R1736030	12,48
POLARIS									
RZR	08-10	R1730040	93,00	R1732010	60,39	R1734010	5,40	R1736010	12,48
SUZUKI									
LTX 400	03-08	R1730020	67,50	R1732020	46,80	R1734020	17,45	R1736020	12,48
LTR 450	06-08	R1730021	71,40	R1732021	49,83	R1734021	15,45	R1736021	12,48
YAMAHA									
YFZ 450	04-09	R1730030	79,50	R1732030	58,50	R1734030	16,90	R1736030	12,48
YFM 700 Raptor	06-10	R1730031	69,00	R1732031	49,50	R1734031	17,10		
YXR 700 Rhino	07-10	R1730033	96,00	R1732010	60,39	R1734010	5,40	R1736010	12,48



Ghisa

Artículo bajo pedido, con plazo de entrega de 3 semanas.



ES

Línea GHISA es nuestra nueva oferta para el mercado! Forma ovalada y pintura con tratamiento cerámico dando más resistencia en altas temperaturas fabricado en material ergal. Ahora está disponible también en versión GHISA EVO fabricados con material de ergal, con copa final en carbono. Este silencioso es la mejor relación calidad-precio de nuestro catálogo, con más de 300 opciones en colección. Se sirven en versión homologada y está provisto de db killer.

FR

Collection GHISA est notre nouvelle offre pour le marché!! Silencieux oval en acier inoxydable avec coloration noire réalisé avec traitement céramique pour hautes températures. Il est également disponible en version GHISA EVO, avec une sortie en carbone. Excellente qualité à des prix compétitifs. La version homologuée est munie d'un dB-killer amovible pour usage sur piste.

EN

GHISA line is our newest offering for the market! The word "Ghisa" is used as a slang term in Milan to mean traffic cop and when someone wants to warn another rider shouts "Ghisa! Close the gas!". So we have created Ghisa to be quiet with low rpm but to still have a great sound and good power when the revs climb and the gas is fully open. Made of stainless steel 304, the black colour finish is created with a ceramic treatment which improves heat resistance. GHISA EVO is provided of a carbon end cap. Homologated version is provided of a removable dbkiller for racing use.



Ghisa Evo

Artículo bajo pedido, con plazo de entrega de 3 semanas.



Fast Powercone



ES

La colección POWERCONE representa la línea más artesanal de nuestro catálogo. Disponible en acero inoxidable, la línea FAST CAN es especialmente indicada para motocicletas Super-Sport Naked, POWERCROSS. Es nuestra línea derivada para el mundo OFF-ROAD. Se puede adquirir en kit silencioso o línea completa. Fabricados en acero inoxidable, hecho a mano y con soldaduras TIG (Tungsten Inert Gas). Todos los escapes están disponibles en versión homologado para uso en carretera dispone de doble db killer extraíble.

FR

Collection POWERCONE représentent la production plus agressive dans notre catalogue 2016. Elle est disponible comme ligne FAST CAN, réservé uniquement à les principales motos supersport et naked, ou la ligne POWERCROSS dédié principalement au monde enduro et cross, tous deux faits en acier inoxydable et fabriquées à la main avec soudures TIG. Option homologué pour un usage routier avec double db killer amovible pour usage sur piste.

EN

FAST CAN line represent the best Italian quality production in GPR catalogue, availableas POWERCONE or POWERCROSS options. This range is dedicated to main supersport and naked motorbikes, products are stainless steel made with amazing tig welding and thanks to a thickness of 0,8mm only it remain really light and powerful. Both types available in racing or homologated version. Homologated and catalytic options are offered with a dual removable dbkiller system unique on market.

Inox Tondo



Deeptone ATV



Trioval



Artículos bajo pedido, con plazo de entrega de 3 semanas.



Tubos de escape

Para listado de aplicaciones entra en gpr.impnesa.com



Albus Ceramic

Artículo bajo pedido, con plazo de entrega de 3 semanas.



Furore aluminio

Artículo bajo pedido, con plazo de entrega de 3 semanas.



Furore negro

Artículo bajo pedido, con plazo de entrega de 3 semanas.



ES

La gamma con más demanda de la colección GPR es la línea Furore, disponible en colores negro, aluminio, look de carbono o Albus, totalmente en color blanco. Esta línea es compacta, ligera y potente. Las partes inferiores y las entradas se fabrican en material CNC. La novedad consiste en el diferente procesamiento para la versión Albus, ésta versión tiene un tratamiento cerámico. Con el fin de mejorar la calidad y dar una mayor resistencia al calor. Ayudando a no envejecer su aspecto. La Línea Furore está disponible en opción racing y homologado. Las versiones homologadas y catalíticas se ofrecen con un sistema dual DB Killer extraíble.

FR

Le plus aimé parmi les collections GPR est la famille Furore, disponible en aluminium, noir et look carbone ou en version Albus, complètement blanche. Compact, léger, puissant et pas cher! Qu'est-ce que vous pourriez demander plus? Endcaps et entrée fabriqués en ergal avec CNC centre, ce genre de production accorder l'assemblage parfait et son incroyable! La nouveauté est le renouvellement de l'usinage pour la finition noir et Albus: pas plus dans la peinture simple, mais avec un nouveau traitement en céramique, afin d'accroître encore la qualité, avec traitement effectué sur la pièce finie et non sur les composants, avec une plus grande résistance à la chaleur et de l'impact. Les versions homologués et catalytiques sont équipées de double dbkiller amovible pour une utilisation sur piste.

EN

Furore and Albus line! Looking to these pipes you can understand why "style" in exhausts word means "GPR"! Compact, light, powerful and not expensive! What could you ask more? Endcaps and entrance made in ergal with CNC center, this kind of production grant perfect assembling and incredible sound! Albus and black finish are now realized with new ceramic treatment to improve heat resistance and durability. Furore line is available in homologated and racing options. Homologated and catalytic versions are offered with a dual removable dbkiller system unique on the market.

ADMISIÓN / ESCAPE / REFRIGERACIÓN

BRONCO Juntas colector y escape



Referencia	Exterior	Interior	Ancho
DAT02206	46,4	42	25
DAT02207	34,7	28,7	25,2
DAT02208	56,1 / 48,3	41,7	10,2
DAT02209	37,5	31,7	26,7
DAT02210	50	40,2	5
DAT02211	32,7	22,4	4,1
DAT02212	42,4	31,9	3,4
DAT02213	44,7	38,6	5,3
DAT02214	45	37,1	4,1
DAT02215	39,5	30,8	2,5
DAT02216	40,5	32,7	3,7
DAT02217	42	35,3	5,5
DAT02218	43	34,5	5
DAT02219	43	35	4
DAT02220	40	31,7	4,2
DAT02221	54,3 / 44,2	38,6	10,4
DAT02222	41,2	35	26

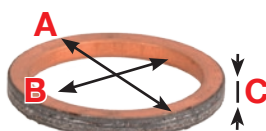

Referencia	Exterior	Interior	Ancho
DAT02223	58,1	42,6 / 43	14
DAT02224	36	32	32
DAT02225	34,6	28,7	28,2
DAT02227	44,3	38,3	24,5
DAT02228	41	35	25
DAT02229	37	32,2	26,2
DAT02230	41,2	35,2	31,3
DAT02231	36,3	31,7	30,7
DAT02234	46,8	42,2	25,5
DAT02235	32,7	28,7	30,5
DMC02205	44,5	38,4	25
DMC02208	31,4	25,5	27,7
DMC02211	37,2	32	25
DMC02213	34,6	28,8	25,5
DMC02218	38,6	35	25,3
DMC02221	38,7	31,7	25
DMC02227	37,4	31,6	30,8

CULATA - COLECTOR					COLECTOR - SILENCIOSO		
HONDA	Año	Ref. Original	Referencia	€	Ref. Original	Referencia	€
TRX 90	93-05	18391-HB7-000	DMC02208	9,00			
TRX 125	87-88	18291-MN5-650	DAT02220	2,50			
TRX 250	85-87	18291-MN4-920	DAT02219	2,50	18391-ML8-000	DMC02211	9,00
TRX 250	97-01	18291-MN4-920	DAT02219	2,50	18391-HM8-000	DMC02213	9,00
TRX 250 Recon	01-11	18291-MN5-650	DAT02220	2,50			
TRX 250 TE/TM	02-16	18291-MN5-650	DAT02220	2,50	18391-HM8-000	DAT02207	9,00
TRX 250 Sportrax	01-16	18291-MN4-920	DAT02219	2,50	18391-HM8-000	DAT02207	9,00
TRX 300 FW	88-00	18291-MN4-920	DAT02219	2,50			
TRX 300 Sportrax	93-09	18291-MV9-000	DAT02219	2,50	18391-MN5-650	DAT02222	9,00
TRX 350 Rancher	00-06	18291-MN4-920	DAT02219	2,50	18391-ML8-000	DMC02211	9,00
TRX 400	95-97				18391-MN5-650	DAT02222	9,00
TRX 400 Rancher	2007	18291-MN4-920	DAT02219	2,50	18391-MN5-650	DAT02222	9,00
TRX 400 FW	98-03	18291-MN4-920	DAT02219	2,50	18391-MN5-650	DAT02222	9,00
TRX 400 Sportrax	99-02		DAT02220	2,50	18392-MK4-000	DMC02205	9,00
TRX 420 Rancher	07-16	18291-MN4-920	DAT02219	2,50	18391-MN5-650	DAT02222	9,00
TRX 450 Foreman	02-04	18291-MN4-920	DAT02219	2,50	18391-MN5-650	DAT02222	9,00
TRX 450 R	04-05				18392-MK4-000	DMC02205	9,00
TRX 500 Foreman	01-13	18291-MM5-860	DAT02219	2,50	18392-MBH-000	DAT02222	9,00
TRX 500 Rubicon	01-13	18291-MM5-860	DAT02219	2,50	18392-MBH-000	DAT02222	9,00
TRX 650 Rincon	03-05	18291-MM5-860	DAT02214	2,50	18392-MBH-000	DAT02227	9,00
TRX 680 Rincon	06-16	18291-MM5-860	DAT02214	2,50	18392-MBH-000	DAT02227	9,00
TRX 700 XX	08-09				18392-MK4-000	DMC02205	9,00

CULATA - COLECTOR					COLECTOR - SILENCIOSO		
KAWASAKI	Año	Ref. Original	Referencia	€	Ref. Original	Referencia	€
KLF 220 Bayou	88-02	11009-1866	DAT02215	2,50	11009-1718	DAT02209	9,00
KLF 250 Bayou	03-11	11009-1866	DAT02215	2,50	11009-1718	DAT02209	9,00
KLF 300 Bayou	86-87	11009-1866	DAT02215	2,50	11009-1667	DAT02228	9,00
KLF 300 Bayou	88-05	11009-1866	DAT02215	2,50	11009-1718	DAT02209	9,00
KEF 300 Lakota	95-03	11009-1866	DAT02215	2,50	11009-1718	DAT02209	9,00
KVF 300 Brute Force	12-15	11061-Y032	DAT02256	2,50	11061-Y033	DAT02240	
KVF 300 Prairie	99-02	11009-1866	DAT02215	2,50	11009-1667	DAT02228	9,00
KVF 360 Prairie	03-12				11009-1667	DAT02228	9,00
KLF 400 Bayou	93-99	11009-1866	DAT02215	2,50	11009-1667	DAT02228	9,00
KVF 400 Prairie	97-02	11009-1866	DAT02215	2,50	11009-1667	DAT02228	9,00
KFX 450 R	08-14	11061-0226	DAT02239		11061-0298	DAT02241	
KFX 450 R Colector medio	08-14				11061-0082	DAT02254	2,50
KVF 650 Prairie	02-03	11009-1894	DAT02216	2,50	11061-0360	DAT02229	9,00
KVF 650 Brute Force	05-13	11009-1894	DAT02216	2,50	11061-0360	DAT02229	9,00
KVF 700 Prairie	2004	11009-1894	DAT02216	2,50			
KFX 700	04-09	11009-1894	DAT02216	2,50	11061-0360	DAT02229	9,00
KVF 750 Brute Force	05-14	11009-1894	DAT02216	2,50	11061-0360	DAT02229	9,00
KRF 750 Teryx	08-13	11009-1894	DAT02216	2,50	11061-0360	DAT02229	9,00

ADMISIÓN / ESCAPE / REFRIGERACIÓN

BRONCO Juntas colector y escape



RUEDAS Y NEUMÁTICOS
MOTOR
ADMISIÓN / ESCAPE REFRIGERACIÓN
ELÉCTRICO
SUSPENSIÓN / DIRECCIÓN
FRENS
TRANSMISIÓN
CONTROLES Y MANDOS
CHASIS
ACCESORIOS

POLARIS	CULATA - COLECTOR				COLECTOR - SILENCIOSO		
	Año	Ref. Original	Referencia	€	Ref. Original	Referencia	€
300 Hawkeye	2006				5249951	DAT02230	9,00
300 Hawkeye	07-11	5243518	DAT02208	10,50	5243518	DAT02208	10,50
300 Sportsman	08-10	5243518	DAT02208	10,50	5243518	DAT02208	10,50
325 Xpedition	00-02	5243517	DAT02221	10,50	5243517	DAT02221	10,50
325 Magnum	00-02	5243517	DAT02221	10,50	5243517	DAT02221	10,50
325 Trail Boss	00-02	5243517	DAT02221	10,50	5243517	DAT02221	10,50
330 Magnum	03-06	5243517	DAT02221	10,50	5243517	DAT02221	10,50
330 Trail Boss	04-12	5243517	DAT02221	10,50	5243517	DAT02221	10,50
330 Trail Blazer	08-13	5243517	DAT02221	10,50	5243517	DAT02221	10,50
400 Ranger	10-12	5243518	DAT02208	10,50	5243518	DAT02208	10,50
400 Sportsman	01-05	5243518	DAT02208	10,50	5243518	DAT02208	10,50
400 Sportsman HO	08-12	5243518	DAT02208	10,50	5243518	DAT02208	10,50
400 Hawkeye HO	11-13	5243518	DAT02208	10,50	5243518	DAT02208	10,50
425 Xpedition	00-02	5243517	DAT02221	10,50	5243517	DAT02221	10,50
450 Sportsman	06-07	5243518	DAT02208	10,50	5243518	DAT02208	10,50
500 Magnum	00-03	5243517	DAT02221	10,50	5243517	DAT02221	10,50
500 Ranger	06-08	5243518	DAT02208	10,50	5243518	DAT02208	10,50
500 Scrambler	00-12	5243518	DAT02208	10,50	5243518	DAT02208	10,50
500 Sportsman	01-13	5243518	DAT02208	10,50	5243518	DAT02208	10,50
570 RZR	12-13	3610181	DAT02236	10,50			
600 Sportsman	03-05	3610047	DSM02038	10,50	3610047	DSM02038	10,50
700 Ranger	07-09	5243518	DAT02208	10,50	5243518	DAT02208	10,50
700 Sportsman	02-06	3610047	DSM02038	10,50	3610047	DSM02038	10,50
700 Sportsman	07-08	3610047	DSM02038	10,50	3610119	DAT02260	12,00
800 Ranger	10-11	5243518	DAT02208	10,50	5243518	DAT02208	10,50
800 Sportsman	05-06	3610047	DSM02038	10,50			
800 Sportsman	07-13	3610047	DSM02038	10,50	3610119	DAT02260	12,00
800 Sportsman	14-15	3610181	DAT02236	10,50	3610119	DAT02260	12,00
800 RZR	08-11	3610047	DSM02038	10,50			
800 RZR	2012	3610181	DAT02236	10,50			

SUZUKI	CULATA - COLECTOR				COLECTOR - SILENCIOSO		
	Año	Ref. Original	Referencia	€	Ref. Original	Referencia	€
LT-F 250 Quadrunner	88-02	14181-42A00	DAT02218	7,00	14773-14202	DAT02231	10,50
LT-F 250 Ozark	03-12	14181-42A00	DAT02218	7,00	14771-19B00	DAT02231	10,50
LT-Z 250 QuadSport	02-09	14181-42A00	DAT02218	7,00	14771-19B00	DAT02231	10,50
LT-F 300 Kingquad	99-02	14181-42A00	DAT02218	7,00	14771-19B00	DAT02231	10,50
LT-A 400 Eiger	02-07	14181-18C00	DAT02217	7,00	14771-38F00	DMC02221	9,00
LT-F 400 Eiger	02-07	14181-18C00	DAT02217	7,00	14771-38F00	DMC02221	9,00
LT-A 400 King Quad	09-12	14181-18C00	DAT02217	7,00	14771-38F00	DMC02221	9,00
LT-A 450 King quad	07-10	14181-18C00	DAT02217	7,00	14771-13E00	DMC02218	7,50
LT-R 450 Quadracer	06-07	14181-35G00	DAT02252	2,50			
LT-R 450 Quadracer	08-09	14181-35G00	DAT02252	2,50	14771-45G00	DAT02206	13,60
LT-F 500 Quadrunner	98-01	14181-18C00	DAT02217	7,00	14771-13E00	DMC02218	7,50
LT-A 500 Vinson	02-03	14181-18C00	DAT02217	7,00	14771-13E00	DMC02218	7,50
LT-F 500 Vinson	02-03	14181-18C00	DAT02217	7,00	14771-13E00	DMC02218	7,50
LT-A 500 King quad	04-12	14181-18C00	DAT02217	7,00	14771-13E00	DMC02218	7,50
LT-A 550 King Quad	2012	14181-18C00	DAT02217	7,00	14771-13E00	DMC02218	7,50
LT-V 700 Twin Peaks	05-07	14181-29E02	DAT02210	5,00	14771-45G00	DAT02206	13,60
LT-A 750 King Quad	08-12	14181-29E02	DAT02210	5,00	14771-45G00	DAT02206	13,60

YAMAHA	CULATA - COLECTOR				COLECTOR - SILENCIOSO		
	Año	Ref. Original	Referencia	€	Ref. Original	Referencia	€
YFM 80 Raptor	02-08	3DM-14613-00-00	DAT02211	6,00			
YFM 80 Badger	92-01	3DM-14613-00-00	DAT02211	6,00			
YFA 125 Breeze	91-04	3DM-14613-00-00	DAT02211	6,00			
YFM 125 Grizzly	04-12	3DM-14613-00-00	DAT02211	6,00			
YFM 250 Beartracker	99-04	4BE-14613-00-00	DAT02213	2,50	3YF-14714-00-00	DMC02227	9,00
YFB 250 Timberwolf	94-98	4BE-14613-00-00	DAT02213	2,50	3YF-14714-00-00	DMC02227	9,00
YFM 250 Big Bear	07-09	4BE-14613-00-00	DAT02213	2,50	3YF-14714-00-00	DMC02227	9,00
YFM 350 Bruin	04-06	3GD-14613-00-00	DAT02210	5,00	3YF-14714-00-00	DMC02227	9,00
YFM 350 Grizzly	07-15	3GD-14613-00-00	DAT02210	5,00	3YF-14714-00-00	DMC02227	9,00
YFM 350 Raptor	04-13	3GD-14613-00-00	DAT02210	5,00	4WM-14755-00-00	DAT02206	13,60
YFM 350 Warrior	87-04	3GD-14613-00-00	DAT02210	5,00	3YF-14755-00-00	DAT02234	12,00
YFM 400 Kodiak	00-06	3GD-14613-00-00	DAT02210	5,00	3YF-14714-00-00	DMC02227	9,00
YFM 450 Grizzly	07-15	3GD-14613-00-00	DAT02210	5,00	3YF-14714-00-00	DMC02227	9,00
YFM 450 Kodiak	04-06	3GD-14613-00-00	DAT02210	5,00	3YF-14714-00-00	DMC02227	9,00
YFZ 450	04-13	3VD-14613-00-00	DMX02201	2,50	3FA-14714-01-00	DSM02035	18,61
YFZ 450 R	09-16	3VD-14613-00-00	DMX02201	2,50			
YFM 550 Grizzly	09-15	3YF-14613-01-00	DAT02212	6,00	1HP-E4714-00-00	DAT02223	11,00
YFM 600 Grizzly	98-01	3YF-14613-01-00	DAT02212	6,00	3YF-14755-00-00	DAT02234	12,00
YFM 660 Grizzly	02-08	3YF-14613-01-00	DAT02212	6,00	3YF-14755-00-00	DAT02234	12,00
YFM 660 Raptor	01-05	3YF-14613-01-00	DAT02212	6,00	5LP-14714-00-00	DAT02206	13,60
YFM 660 R(colector medio)	01-05	3YF-14714-00-00	DMC02227	9,00			
YFM 700 Grizzly	07-15	3YF-14613-01-00	DAT02212	6,00	1HP-E4714-00-00	DAT02223	11,00
YFM 700 Raptor	06-15	3YF-14613-01-00	DAT02212	6,00	5LP-14714-00-00	DAT02206	13,60
YFM 700 R(colector medio)	06-15	3YF-14714-00-00	DMC02227	9,00			
YXR 700 Rhino	08-13	3YF-14613-01-00	DAT02212	6,00	3B4-14714-00-00	DAT02223	11,00
YXR 700 Rhino(col. Medio)	08-13	3B4-14714-00-00	DAT02223	11,00			

Saca muelles



Referencia	€
DUP12351	6,98

Fibra silencioso 1100°C

Referencia	Largo	Ancho	Grosor	€
DMC021111	1000 mm	330 mm	6 mm	23,35



XPEED

Tapón silencioso



Referencia	Descripción	€
DMX02004	Pequeño Ø10 a 30mm	6,60
DMX02005	Grande Ø27 a 49mm	6,60

Codos unión manguitos radiador

Fabricados en aluminio 6062. Se entregan con 2 bridas de sujeción.



Referencia	Descripción	€
DUP10000	Tubo recto aluminio, diámetro 16 mm / largo 43 mm	13,51
DUP10001	Tubo recto aluminio, diámetro 19 mm / largo 43 mm	13,51
DUP10002	Tubo recto aluminio, diámetro 21 mm / largo 43 mm	13,51
DUP10003	Tubo recto aluminio, diámetro 25 mm / largo 43 mm	13,51
DUP10004	Tubo recto aluminio, diámetro 28 mm / largo 43 mm	13,51
DUP10005	Tubo recto aluminio, diámetro 30 mm / largo 43 mm	13,51
DUP10006	Codo de aluminio, grados 45° / diámetro 16 mm / largo 80 mm	15,82
DUP10007	Codo de aluminio, grados 45° / diámetro 19 mm / largo 80 mm	15,82
DUP10008	Codo de aluminio, grados 45° / diámetro 21 mm / largo 80 mm	15,82
DUP10009	Codo de aluminio, grados 45° / diámetro 25 mm / largo 80 mm	15,82
DUP10010	Codo de aluminio, grados 45° / diámetro 28 mm / largo 80 mm	15,82
DUP10011	Codo de aluminio, grados 45° / diámetro 30 mm / largo 80 mm	15,82
DUP10012	Codo de aluminio, grados 90° / diámetro 16 mm / largo 115 mm	18,13
DUP10013	Codo de aluminio, grados 90° / diámetro 19 mm / largo 115 mm	18,13
DUP10014	Codo de aluminio, grados 90° / diámetro 21 mm / largo 115 mm	18,13
DUP10015	Codo de aluminio, grados 90° / diámetro 25 mm / largo 115 mm	18,13
DUP10016	Codo de aluminio, grados 90° / diámetro 28 mm / largo 115 mm	18,13
DUP10017	Codo de aluminio, grados 90° / diámetro 30 mm / largo 115 mm	18,13

BRONCO Radiadores

Con su grosor de 40mm, incrementa entre un 20% y un 30% la cantidad de anticongelante, para mejorar la refrigeración. Aluminio de alta calidad soldado con TIG.

No es necesario modificaciones, se utiliza anclajes y tornillería original.

HONDA	Año	Referencia	Descripción	€
TRX 450 R	04-09	DAC10001	Radiador sobredimensionado	140
KAWASAKI	Año	Referencia	Descripción	€
KFX 450	08-12	DAC10003	Radiador sobredimensionado	140
POLARIS	Año	Referencia	Descripción	€
Outlaw 450 S	08-10	DAC10011	Radiador sobredimensionado	160
Outlaw 500	03-07	DAC10011	Radiador sobredimensionado	160
Predator 500	03-07	DAC10005	Radiador sobredimensionado	140
Outlaw 525	07-11	DAC10011	Radiador sobredimensionado	160
RZR 800	07-12	DAC10010	Radiador sobredimensionado	160
SUZUKI	Año	Referencia	Descripción	€
LT-R 450	06-09	DAC10004	Radiador sobredimensionado	140
LT-Z 400	03-08	DAC10012	Radiador sobredimensionado	140
YAMAHA	Año	Referencia	Descripción	€
YFZ 350 Banshee	87-07	DAC10000	Radiador sobredimensionado	140
YFZ 450	04-13	DAC10002	Radiador sobredimensionado	140
YXR 450 Rhino	04-09	DAC10007	Radiador sobredimensionado	140
YFM 550 Grizzly	07-14	DAC10014	Radiador sobredimensionado	160
YFM 660 Raptor	01-05	DAC10006	Radiador sobredimensionado	140
YXR 660 Rhino	04-09	DAC10007	Radiador sobredimensionado	140
YFM 700 Grizzly	07-14	DAC10014	Radiador sobredimensionado	160
YFM 700 Raptor	06-13	DAC10008	Radiador sobredimensionado	160



4PLAY Sensor temperatura

KAWASAKI	Año	Referencia
KLF 400 Bayou	93-99	DAT01366
KVF 400 Prairie	97-02	DAT01366
KVF 650 Brute Force	05-13	DAT01366
KVF 650i Brute Force	06-13	DAT01366
KVF 650 Prairie	02-03	DAT01366
KFX 700 V-Force	04-09	DAT01366
KVF 700 Prairie	04-06	DAT01366
KVF 750 Brute Force	05-07	DAT01366
KRF 750 Teryx	2008	DAT01366
POLARIS	Año	Referencia
400 Hawkeye	12-14	DAT01369
400 Hawkeye HO	11-14	DAT01372
400 Scrambler	01-02	DAT01373
400 Sportsman	01-04	DAT01373
400 Sportsman HO	11-14	DAT01372
500 Magnum	00-02	DAT01373
500 Scrambler	01-03	DAT01373
500 Sportsman	00-04	DAT01373
500 Sportsman	03-04	DAT01369
500 Sportsman HO	08-14	DAT01369
500 Outlaw	06-07	DAT01369
500 Predator	04-07	DAT01369
500 Scrambler	2003	DAT01369
500 Sportsman	03-04	DAT01369

500 Sportsman	06-14	DAT01362
500 Sportsman HO	09-13	DAT01369
500 Sportsman HO	09-13	DAT01372
500 Sportsman Forest	11-13	DAT01369
500 Sportsman Forest	11-13	DAT01372
500 Sportsman Touring	10-13	DAT01362
500 Sportsman Touring	10-13	DAT01372
550 Sportsman	10-14	DAT01362
570 Sportsman	2014	DAT01364
600 Sportsman	03-04	DAT01373
700 Sportsman	02-04	DAT01373
700 Sportsman	04-08	DAT01364
800 Sportsman	05-14	DAT01364
850 Sportsman	09-14	DAT01364
850 Scrambler	13-14	DAT01364
1000 Scrambler	2014	DAT01364
YAMAHA	Año	Referencia
YFZ 450 R	09-14	DAT01363
YFM 550 Grizzly	09-14	DAT01363
YFM 700 Grizzly	07-13	DAT01363
YXR 700 Rhino	08-13	DAT01363



DAT01363



DAT01364

€
25

RUEDAS Y NEUMÁTICOS

MOTOR

ADMISIÓN / ESCAPE
REFRIGERACIÓN

ELECTRICO

SUSPENSIÓN / DIRECCIÓN

FRENOS

TRANSMISIÓN

CONTROLES Y MANDOS

CHASIS

ACCESORIOS

4PLAY Termocontactos ventilador

El termocontacto conecta a partir de la temperatura marcada

HONDA	Año	Referencia	Descripción	€
TRX 350 Rancher	00-06	DAT01382		24,68
TRX 400 Rancher	04-07	DAT01382		24,68
TRX 500 Rubicon	05-14	DAT01382		24,68
TRX 650 Rincon	03-05	DAT01382		24,68

KAWASAKI	Año	Referencia	Descripción	€
KLF 400 Bayou	98-99	DAT01386	100 °C	25,61
KVF 400 Prairie	97-02	DAT01386	100 °C	25,61
KVF 650 Brute Force	05-10	DAT01386	100 °C	25,61
KVF 650 Brute Force	11-13	DAT01379	95 °C	25,61
KVF 650i Brute Force	06-10	DAT01386	100 °C	25,61
KVF 650 Prairie	02-03	DAT01386	100 °C	25,61
KFX 700 V-Force	04-09	DAT01386	100 °C	25,61
KVF 700 Prairie	04-06	DAT01386	100 °C	25,61

POLARIS	Año	Referencia	Descripción	€
250 Trail Blazer	1998	DAT01377	85 °C	23,89
300 Xpress	96-97	DAT01377	85 °C	23,89
325 Trail Boss	2001	DAT01377	85 °C	23,89
335 Sportsman	2000	DAT01377	85 °C	23,89
400 Scrambler	1999	DAT01377	85 °C	23,89
400 Sportsman	1997	DAT01377	85 °C	23,89
400 Xplorer	97-00	DAT01377	85 °C	23,89
400 Xpress	96-97	DAT01377	85 °C	23,89
400 L	1996	DAT01377	85 °C	23,89
500 Scrambler	97-01	DAT01377	85 °C	23,89
500 Sportsman	96-99	DAT01377	85 °C	23,89
500 Worker	1999	DAT01377	85 °C	23,89
500 Xplorer	1997	DAT01377	85 °C	23,89

SUZUKI	Año	Referencia	Descripción	€
LT-Z 400	03-08	DAT01375	85 °C	25,61
LT-A 450 King Quad	07-10	DAT01374	90 °C	25,61
LT-A 450 King Quad	07-10	DAT01375	85 °C	25,61
LT-A 500 King Quad	09-14	DAT01374	85 °C	25,61
LT-A 500 King Quad	09-14	DAT01375	90 °C	25,61
LT-A 500 Vinson	02-07	DAT01375	85 °C	25,61
LT-F 500 Vinson	02-06	DAT01375	85 °C	25,61
LT-F 500 Quad Master	98-01	DAT01375	85 °C	25,61
LT-F 500 Quad Runner	98-02	DAT01375	85 °C	25,61
LT-A 700 King Quad	05-07	DAT01374	90 °C	25,61
LT-A 700 King Quad	05-07	DAT01375	85 °C	25,61
LT-A 750 King Quad	08-13	DAT01374	90 °C	25,61
LT-A 750 King Quad	08-13	DAT01375	85 °C	25,61

YAMAHA	Año	Referencia	Descripción	€
YXR 450 Rhino	06-09	DAT01378	75 °C	25,61
YFM 660 Grizzly	02-08	DAT01378	75 °C	25,61
YXR 660 Rhino	04-07	DAT01378	75 °C	25,61
YFM 700 Raptor	2015	DSM01260	25 °C = 1987 ohms 100 °C = 186 ohms	20,33



DAT01386



DAT01377



DAT01375



DAT01378



Difusor temperatura radiador

Ø Interior 13,5mm Ø Exterior 18,8mm

Referencia	€
R160010	11,85



Rejas protección radiador

Dimensiones 20x30cm.
Fabricadas en aluminio.

Referencia	€
PLATEADA DMP12081S	6,44
NEGRA DMP12081	6,44

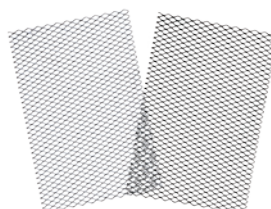

ELÉCTRICO



BRONCO Baterías

Todas las baterías Bronco llevan el ácido incluido. Las baterías sin mantenimiento o las baterías secas sólo se pueden recargar con cargadores de impulsos o de baja intensidad de carga. Todas las baterías llevan el ácido incluido, menos las referencias en azul son baterías Xpeed con mantenimiento y no llevan el ácido incluido.

Las referencias en color azul indican las baterías con mantenimiento, se entregan sin ácido. / * Batería con mantenimiento, ácido incluido

ARCTIC CAT	Año	Referencia	€
550 Todos	09-13	YTX20-BS	73,20
700 Todos	09-13	YTX20-BS	73,20
1000 Todos	09-13	YTX20-BS	73,20

CAN AM	Año	Referencia	€
Rally 200	02-06	YTX14AH-BS	50,50
Outlander 330	04-05	YTX15L-BS	54,79
Outlander 400	03-04	YTX15L-BS	54,79
Outlander 400 XT	04-12	YTX20L-BS	73,20
Outlander 400 Max	04-12	YTX20L-BS	73,20
DS 450	09-12	YT7B-BS	37,99
DS 650	00-06	YTX15L-BS	54,79
Outlander 650	09-12	YTX20L-BS	73,20
Outlander 650 Max	09-12	YTX20L-BS	73,20
Commander 800	11-13	YTX20L-BS	73,20
Outlander 800	06-12	YTX20L-BS	73,20
Renegade 800	06-12	YTX20L-BS	73,20
Commander 1000	11-13	YTX20L-BS	73,20
Outlander 1000	12-13	YTX20L-BS	73,20
Renegade 1000	12-13	YTX20L-BS	73,20

GAS GAS	Año	Referencia	€
Wild 450 HP	todos	YTX9-BS	36,10

GOES	Año	Referencia	€
220	todos	YTX12-BS	45,26
300	todos	YTX12-BS	45,26
320	todos	YTX12-BS	45,26
450	todos	YTX9-BS	36,10
520	todos	YTX20L-BS	73,20

HONDA	Año	Referencia	€
TRX 250 Recon	97-11	YTX12-BS	45,26
TRX 250 Sportrax	01-12	YTX9-BS	36,10
TRX 300 Sportrax	93-12	YTX9-BS	36,10
TRX 350 Rancher	00-06	YTX14-BS	50,50
TRX 400 Foreman	95-03	YTX14-BS	50,50
TRX 400 Rancher	04-06	YTX14-BS	50,50
TRX 400 Sportrax	99-12	YTX9-BS	36,10
TRX 450 Foreman	98-04	YTX14-BS	50,50
TRX 450 R	06-12	YTZ7S-BS	35,62
TRX 500 Rubicon	01-11	YTX14-BS	50,50
TRX 500 Foreman	05-11	YTX14-BS	50,50
TRX 650 Rincon	03-05	YTX20L-BS	73,20
TRX 680 Rincon	06-12	YTX20L-BS	73,20
TRX 700 xx	08-10	YTX9-BS	36,10

KAWASAKI	Año	Referencia	€
KLF 250 Bayou	03-12		
KEF 300 Lakota	95-03	YTX14AH-BS	50,50
KLF 300 Bayou	88-04	YTX14AH-BS	50,50
KVF 300 Prairie	99-02	YTX14AH-BS	50,50
KVF 360 Prairie	09-11	YTX14AH-BS	50,50
KFX 400	03-06	YTX9-BS	36,10
KLF 400 Bayou	93-00	X01163	43,00
KVF 400 Prairie	97-02	YTX14AH-BS	50,50
KFX 450 R	08-12	YTX7L-BS	29,14
KVF 650 Brute Force	05-11	YTX14-BS	50,50
KVF 650i Brute Force	06-12	YTX14-BS	50,50
KVF 650 Prairie	02-03	YTX14-BS	50,50
KFX 700 V-Force	04-09	YTX14-BS	50,50
KVF 700 Prairie	04-06	YTX14-BS	50,50
KVF 750 Brute Force	05-12	YTX14-BS	50,50

KTM	Año	Referencia	€
450 SX	08-11	YTZ7S-BS	35,62
450 XC	08-11	YTZ7S-BS	35,62
505 SX	08-11	YTZ7S-BS	35,62
525 XC	10-11	YTZ7S-BS	35,62

KYMCO	Año	Referencia	€
Mongoose 50	todos	YTX5L-BS	22,87
MXU 50	todos	YTX9-BS	36,10
MXU 150	todos	YTX9-BS	36,10
MXU 250	todos	YTX12-BS	45,26
KXR 250	todos	YTX12-BS	45,26
Maxxer 300	todos	YTX12-BS	45,26
MXU 300	todos	YTX12-BS	45,26
MXU 500	todos	YTX20L-BS	73,20
UXV 500	todos	YTX20L-BS	73,20

POLARIS	Año	Referencia	€
Phoenix 200	05-12	YTX12-BS	45,26
Sawtooth 200	05-12	YTX12-BS	45,26
todos 250	85-05	YTX14AH-BS	50,50
todos 325	87-02	YTX14AH-BS	50,50
Magnum 330	03-12	YTX14AH-BS	50,50
Sportsman 330	03-12	YTX14AH-BS	50,50
Trail Boss 330	03-12	YTX14AH-BS	50,50
Sportsman 335	98-01	YTX14AH-BS	50,50
todos 400	94-08	YTX14AH-BS	50,50
Sportsman 400	09-11	YTX14AH-BS	50,50
todos 425	95-02	YTX14AH-BS	50,50
Sportsman 500	96-12	YTX14AH-BS	50,50
Sportsman 500 EFI	06-10	YB30L-B*	85,46
Outlaw 525	08-11	YTX9-BS	36,10
Sportsman 550	09-10	YTX20HL-BS	75,75
Sportsman 550 EPS	10-12	YTX14AH-BS	50,50
Sportsman 550 XP	10-12	YTX14AH-BS	50,50
Sportsman 600	04-05	YB30L-B*	85,46
Sportsman 700	09-10	YB30L-B*	85,46
RZR 800	09-12	YTX20L-BS	73,20
RZR 800 4	10-12	YTX20L-BS	73,20
Sportsman 800	05-12	YB30L-B*	85,46
Sportsman 850		YB30L-B*	85,46

SUZUKI	Año	Referencia	€
LT-Z 50 Quad Sport	06-11	YTX5L-BS	22,87
LT 80 Quad Sport	87-06	YTX5L-BS	22,87
LT-Z 90 Quad Sport	07-11	YTX7A-BS	29,14
LT-F 250 Ozark	02-12	YTX12-BS	45,26
LT-Z 250 Quad Sport	04-11	YTX9-BS	36,10
LT-A 400 Eiger	02-07	YTX14-BS	50,50
LT-F 400 Eiger	02-07	YTX14-BS	50,50
LT-Z 400 Quad Sport	03-12	YTX9-BS	36,10
LT-A 400 King Quad	09-12	YTX14-BS	50,50
LT-A 450 King Quad	07-11	YTX14-BS	50,50
LT-R 450 Quad Racer	06-11	YTX7A-BS	29,14
LT-A 500 Quad Master	00-01	YTX16-BS-1	58,70
LT-A 500 Vinson	02-03	YTX16-BS-1	58,70
LT-F 500 Vinson	02-03	YTX16-BS-1	58,70
LT-A 700 King Quad	05-07	YTX16-BS-1	58,70
LT-A 700 King Quad	05-07	YTX20CH-BS	75,75
LT-V 700 Twin Peaks	04-06	YTX14-BS	50,50
LT-A 750 King Quad	07-12	YTX20CH-BS	75,75

YAMAHA	Año	Referencia	€
YFM 90 Raptor	09-13	YTZ7S-BS	35,62
YFA1 125 Brezze	89-04	X01123	25,20
YFM 125 Grizzly	04-13	X01123	25,20
YFB 250 Timberwolf	92-00	X01123	25,20
YFM 250 Bear Tracker	99-04	YTX14AH-BS	50,50
YFM 250 Big Bear	07-10	YTX14AH-BS	50,50
YFM 250 Bruin	05-06	YTX14AH-BS	50,50
YFM 250 Raptor	08-13	YTZ7S-BS	35,62
YFM 350 Big Bear	87-99	YTX14AH-BS	50,50
YFM 350 Bruin	04-06	YTX14AH-BS	50,50
YFM 350 Grizzly	07-15	YTX14AH-BS	50,50
YFM 350 Wolverine	95-05	X01123	25,20
YFM 350 Wolverine	06-10	YTX14AH-BS	50,50
YFM 350 Raptor	04-13	YTZ10S-BS	43,83
YFM 350 Warrior	87-04	X01123	25,20
YFM 400 Big Bear	00-12	YTX20L-BS	73,20
YFM 400 Grizzly	07-08	YTX14AH-BS	50,50
YFM 400 Kodiak	93-95	YTX14AH-BS	50,50
YFM 400 Kodiak autom.	00-02	YTX14AH-BS	50,50
YFM 400 Kodiak autom.	03-06	YTX20L-BS	73,20
YFM 450 Grizzly	07-15	YTX20L-BS	73,20
YFM 450 Kodiak	04-06	YTX20L-BS	73,20
YFM 450 Wolverine	03-10	YTX20L-BS	73,20
YFZ 450	04-13	YT7B-BS	37,99
YFZ 450 R	09-15	YTZ7S-BS	35,62
YFM 550 Grizzly	09-15	YTX20L-BS	73,20
YFM 600 Grizzly	98-01	YTX20L-BS	73,20
YFM 660 Grizzly	02-08	YTX20L-BS	73,20
YFM 660 Raptor	01-06	YTX14-BS	50,50
YFM 700 Grizzly	07-15	YTX20L-BS	73,20
YFM 700 Raptor	06-15	YT9B-BS	42,76

Tabla de equivalencias



Modelo	BRONCO		XPEED		BC Litio	
	Referencia	€	Referencia	€	Referencia	€
YB3L-A			X01030	12,35		
YB3L-B			X01031	12,35		
YB4L-B			X01040	12,90		
YTR4A-BS			X02040	20,30		
YT4B-BS			X03040	20,30		
YTX4L-BS	YTX4L-BS	18,59			BCTX5L	64,95
YTZ5S					BCTX5L	64,95
YB5L-B			X01050	20,45		
YT5L-BS			X02050	20,45		
YTX5L-BS	YTX5L-BS	22,87			BCTX5L	64,95
YB7-A			X01070	21,50		
YTX7A-BS	YTX7A-BS	29,14			BCTX9	89,95
YTX7L-BS	YTX7L-BS	29,14	X02070	26,90	BCTX7L	84,95
YT7B-BS	YT7B-BS	37,99	X02072	33,92	BCTX12B	139,95
YTZ7S-BS	YTZ7S-BS	35,62			BCTX7L	84,95
YB9A-A			X01090	26,40		
YB9-B			X01091	23,10		
YT9B-BS	YT9B-BS	42,76				
YTR9-BS					BCTX9	89,95
YTX9-BS	YTX9-BS	36,10			BCTX9	89,95
YB10L-A2			X01000	26,90		
YB10L-B			X01101	26,09		
YB10L-B2			X01102	26,90		
YTZ10S-BS	YTZ10S-BS	43,83			BCTZ10S	129,95
YB12A-A			X01120	32,25		
YB12A-B			X01121	32,25		
YB12B-B2					BCTZ10S	129,95
YB12C-A			X01123	25,20		
YT12B-BS			X02121	40,80	BCT12B	139,95
YTZ12S					BCTZ14S	149,95
YTX12-BS	YTX12-BS	45,26			BCTZ10S	129,95
YTX12A-BS					BCTZ10S	129,95
KMX14-BS					BCTX14H	129,95
YB14L-A2			X01142	36,55		
YB14L-B2			X01143	36,55		
YT14B-BS					BCT12B	139,95
YTZ14S					BCTZ14S	149,95
YTX14-BS	YTX14-BS	50,50			BCTX14H	129,95
YTX14AH-BS	YTX14AH-BS	50,50				
YTX14H-BS					BCTX14H	129,95
YTX15L-BS	YTX15L-BS	54,79			BCTZ20HL	229,95
YB16-B			X01160	43,00		
YB16L-A2					BCTZ20HL	229,95
YB16L-B					BCTZ20HL	229,95
YB16AL-A2			X01161	39,80	BCT12B	139,95
YB16B-A1			X01162	39,80		
YB16CL-B			X01163	43,00		
YB16HL-A-CX					BCTZ20HL	229,95
YTX16-BS	YTX16-BS	58,70				
YTX16-BS-1	YTX16-BS-1	58,70				
YB18L-A			X01180	49,45	BCTZ20HL	229,95
YB18L-A2					BCTZ20HL	229,95
YTX18L-BS					BCTZ20HL	229,95
YTX20-BS	YTX20-BS	73,50				
YTX20CH-BS	YTX20CH-BS	75,75				
YTX20HL-BS	YTX20HL-BS	75,75			BCTZ20HL	229,95
YTX20L-BS	YTX20L-BS	73,50			BCTZ20HL	229,95
YTX24HL-BS					BCTZ20HL	229,95
YB30L-B					BCTX30	249,95
YB30CL-B					BCTX30	249,95
YIX30L					BCTX30	249,95
Y50-N18L-A-CX					BCTZ20HL	229,95
Y50-N18L-A			X01181	51,60	BCTZ20HL	229,95
Y50-N18L-A3			X01182	51,60		
Y60-N24L-B			X01240	61,85	BCTX30	249,95
Y60-N30L-A			X01300	69,90		

RUEDAS Y NEUMÁTICOS

MOTOR

ADMISIÓN / ESCAPE
REFRIGERACIÓN

ELÉCTRICO

SUSPENSIÓN / DIRECCIÓN

FRENOS

TRANSMISIÓN

CONTROLES Y MANDOS

CHASIS

ACCESORIOS

BCTM Baterías Lítio LiFeP04

Baterías Ultra Ligeras, equivale a un 80% mes peso de una batería de ácido-plomo Alta Potencia, alta corriente en arrancada, hasta 50 intentos a máxima potencia (5 en ácido-plomo) Larga Vida, aproximadamente 2000 ciclos de carga (400 las de ácido-plomo) Descarga lenta y rápida carga, con la batería almacenada la descarga es 2% mensual (un 12% ácido-plomo) Garantía de peligrosidad, no es inflamable, no es explosiva, sin riesgos de acidos. Respeta el medio ambiente, no utiliza ácidos, metales pesados, mercurio, cadmio ...

Referencia	Equivalencia	Dimensiones	Peso	CCA	€
BCTX5L	YTX4L-BS YTX5L-BS YTZ5S	113x70x85	0,5 Kg.	105	64,95 €
BCTX7L	YTX7L-BS YTZ7S	113x70x85	0,6 Kg.	160	84,95 €
BCTX9	YTX7A-BS YTX9-BS YTR9-BS	150x87x105	0,8 Kg.	180	89,95 €
BCTZ10S	YTZ10S YTX12-BS YTX12A-BS YB12B-B2	150x87x93	0,8 Kg.	240	129,95 €
BCT12B	YT7B-BS YT9B-BS YT12B-BS YT14B-BS YB16AL-A2	150x65x92	0,8 Kg.	290	139,95 €
BCTX14H	YTX14H-BS KMX14-BS YTX14-BS HVT-B	150x87x93	0,9 Kg.	240	129,95 €
BCTZ14S	YTZ12S YTZ14S YTX14H-BS KMX14-BS YTX14-BS HVT-8	150x87x93	0,9 Kg.	290	149,95 €
BCTZ20HL	YTX20HL-BS YTX24HL-BS YTX15L-BS YTX18L-BS YTX20L-BS YB16HL-A-CX Y50-N18L-A-CX YB16L-B YB16L-A2 YB16VL-B YB18L-A YB18L-A2 Y50-N18L-A Y50N18L-A2	175x87x130	1,2 Kg.	420	229,95 €
BC51913	51814 51913 52015 HG-18-12	181x77x170	1,7 Kg.	450	209,95 €
BCTX30	YIX30L YIX30L-BS Y60N24-A Y60N24AL-B YB30L-B YB30CL-B 52515 53030 53034 YHD-12H HVT-2 HVT-7	167x124x168	2,0 Kg.	540	249,95 €





Booster K1200

€
119,50

Ref. BCK1200



BC BOOSTER K1200

Arrancador para coche y moto.
Potente, ligero y de bolsillo.
Batería portátil de emergencia para SmartPhone y Tablets.
Tecnología LiFePO4 100% segura.
Se puede usar para recargar / alimentar dispositivos electrónicos por USB.
Puerto USB incorporado (5V, 2A).
Linterna de emergencia con luz fija o intermitente, con programa de socorro SOS.
El paquete incluye un juego de adaptadores para los principales modelos y marcas de SmartPhones.

FICHA TÉCNICA

DIMENSIONES	160 x 75 x 28 mm
PESO	380 gr
SALIDA	5V.....2A / 12V.....10A
ENTRADA	12V.....1A
CORRIENTE DE ARRANQUE (CA)	200A
CORRIENTE DE PICO (CP)	400A

RUEDAS Y NEUMÁTICOS

MOTOR

ADMISIÓN / ESCAPE
REFRIGERACIÓN

ELÉCTRICO

SUSPENSIÓN / DIRECCIÓN

FRENOS

TRANSMISIÓN

CONTROLES Y MANDOS

CHASIS

ACCESORIOS

Tabla de medidas de baterías

Referencia	Posición	Ah.	largo x ancho x alto	Kg.	Referencia	Posición	Ah.	largo x ancho x alto	Kg.
12N7D-3B		7	135*75*150	1,78	Y50-N18L-A3		20	205*90*162	5,19
YB3L-A		3	98*56*110	0,97	C60-N24AL-B		28	184*124*175	6,09
YB3L-B		3	98*56*110	0,97	C60-N30L-A		30	184*128*169	6,77
YB4L-B		4	120*70*92	1,18	YB30L-B-1		30	168*132*176	7,47
YB5L-B		5	120*60*130	1,40	YTX5L-BS		4	114*71*106	1,38
YB7-A		7	135*75*133	1,77	YT5L-BS		4	114*71*106	1,38
YB9A-A		9	135*75*155	2,21	YTX7A-BS		6	150*87*94	1,86
YB9-B		9	135*75*139	2,18	YTX7L-BS		6	114*71*131	1,80
YB10A-A2		11	135*90*155	2,98	YTX9-BS		8	150*87*105	2,23
YB10L-A2		11	135*90*145	2,96	YTX12-BS		10	150*87*130	2,85
YB10L-B		11	135*90*145	2,96	YTX14-BS		12	150*87*145	3,37
YB10L-B2		11	135*90*145	2,96	YTX15L-BS		13	175*87*130	3,61
YB12A-A		12	134*80*160	3,10	YTX16-BS-1		14	150*87*161	3,72
YB12A-B		12	134*80*160	3,10	YTX20L-BS		18	175*87*155	4,39
YB12C-A		12	134*80*175	3,12	YTX14AH-BS		12	134*89*166	3,36
YB14-A2		14	134*89*166	3,56	YTX20CH-BS		18	150*87*161	4,20
YB14A-A2		14	134*89*176	3,58	YTX20HL-BS		18	175*87*155	4,39
YB14L-A2		14	134*89*166	3,56	YTR4A-BS		2,3	114*49*86	1,04
YB14L-B2		14	134*89*166	3,56	YT4B-BS		2,5	114*49*86.5	0,98
CB16AL-A2		16	207*71.5*164	3,75	YT7B-BS		6,5	150*65*93	2,27
YB16-B		19	175*100*155	4,51	YTZ7S		6	113*70*105	1,96
YB16B-A1		16	160*90*161	3,71	YT9B-4		8	150*70*105	2,82
YB16CL-B		19	175*100*175	4,72	YTZ10S		8,6	150*87*93	3,12
YB18L-A		18	180*90*162	4,51	YT12B-BS		10	150*69*130	4,05
Y50-N18L-A		20	205*90*162	5,19					



BC Cargadores baterías



Referencia	€
BC900	48,25

BC JUNIOR 900

BC Junior 900 es el cargador de baterías ideal para la recuperación, la carga, la desulfatación y el mantenimiento de todas las baterías de 12V de motocicletas y quads. El dispositivo está diseñado para permanecer siempre conectado a la batería y sin necesidad de desconectarla del vehículo. Recupera baterías profundamente descargadas a partir de una tensión de 1,25 Voltios.

FICHA TÉCNICA	BC JUNIOR 900
Tensión de carga	13,8 V / 14,4 V -nominal 12 V
Corriente de carga	0,9 A máx
Capacidad de batería	1,2 Ah a 100 Ah
Temperatura de funcionamiento	-20° a +50°C



Referencia	€
BCK900	63,25

BC K900 Edge 6V/12V/12V CAN-BUS

BC K900 edge es el cargador, mantenedor y recuperador de baterías más moderno e innovador del mercado. El cargador es ideal para todas las baterías 6/12V (tradicionales con electrolito líquido y tapones removibles, MF, GEL, AGM, VRLA), con función de recarga directa a través de las salidas de 12 V instaladas en vehículos equipados con CAN-Bus (por ejemplo: motos BMW). Recuperación a partir de 1,25 Voltios. Con BC K900 edge se puede elegir entre tres programas específicos : para baterías de 6 voltios, para baterías de 12 voltios y para recargar la batería directamente a través de la toma de 12 voltios de motos equipadas con sistema CAN-Bus. El revolucionario sistema de conexión directa BC KEY-LESS le permite conectarse directamente a la toma de 12V DIN 4165 (instalada en las motocicletas BMW), sin tener que girar la llave y encender el panel de instrumentos.

FICHA TÉCNICA	BC K900 edge
Tensión de carga	6,9V / 7,2 V -nominal 6 V - 13,8 V / 14,4 V -nominal 12 V
Corriente de carga	1 A máx.
Tipos de baterías	6/12 V de plomo-ácido (de gel, húmedas, MF, AGM, VRLA, Ca/Ca)
Capacidad de batería	De 1,2 Ah a 100 Ah
Temperatura de funcionamiento	-20° a +50°C



Referencia	€
BCDUE	70,86

BC DUETTO

BC DUETTO es el cargador inteligente universal para baterías desarrollado para proveer un único dispositivo multi-uso para todas las baterías de moto de 12V. El cargador tiene dos programas de carga diferentes para baterías plomo-ácido y LiFePO4. Su corriente de carga (máx. 1,5 Amp) lo hace ideal no solo para la recuperación, la carga y el mantenimiento de todas las baterías de 12V de motocicletas, ciclomotores y quads, sino también para el mantenimiento de las baterías de coche. Recupera baterías profundamente descargadas a partir de una tensión de 1,25 Voltios. La seguridad está garantizada en todas las etapas de la carga: en caso de bajas temperaturas detectadas por el sensor integrado, se activa el modo POLAR. BC DUETTO no produce chispas y está protegido contra cortocircuitos, inversiones de polaridad, sobrecarga y sobrecalentamiento.

FICHA TÉCNICA	BC DUETTO
Tensión de carga	13,8 V / 14,4 V - nominal 12 V -
Corriente de carga	1,5 A máx.
Tipos de baterías	12 V de plomo-ácido (de gel, abiertas, MF, AGM, VRLA, Ca/Ca...) & 12V LiFePO4
Capacidad de batería - Plomo-ácido	3 Ah a 70 Ah (Carga), hasta 100 Ah (Mantenimiento)
Capacidad de batería -LiFePO4	1 Ah a 100 Ah
Temperatura de funcionamiento	-20° a +50°C



Referencia	€
BC3500	82,23

BC 3500 EVO

BC 3500 EVO es el nuevo producto de la gama BC, con dos programas de carga para coche y moto, con pantalla LCD, voltímetro digital y doble función de cargador y tester de la batería y del sistema de carga del vehículo. BC 3500 EVO es ideal para la recuperación, la carga, la desulfatación, el mantenimiento y el análisis de baterías de 12V, y puede permanecer siempre conectado a la batería sin riesgo y sin necesidad de desconectarla del vehículo. El cargador dispone de dos programas de cargas específicos: CAR MODE con una corriente máxima de 3,5 Amperios, y BIKE MODE con una corriente máxima de 0,9 Amperios. Recupera baterías profundamente descargadas (a partir de una tensión de 1,5 Voltios) El procedimiento automático de test, guiado por las instrucciones en la pantalla LCD, incluye un análisis del estado de la batería en reposo, una prueba en esfuerzo al arranque del motor y una prueba del sistema de carga del vehículo (alternador y regulador).

FICHA TÉCNICA	BC 3500 EVO
Tensión de carga	13,8 V / 14,4 V - nominal 12 V
Corriente de carga	3,5 A máx. (CAR MODE), 0,9 A máx. (BIKE MODE)
Tipos de baterías	12 V de plomo-ácido (de gel , abiertas, MF, AGM, VRLA, Ca/Ca...)
Capacidad de batería -CAR MODE	15 Ah a 80 Ah (Carga), hasta 150 Ah (Mantenimiento)
Capacidad de la batería -BIKE MODE	3 Ah a 60 Ah (Carga), hasta 100 Ah (Mantenimiento)
Temperatura de funcionamiento	-20° a +50° C

BRONCO Motor arranque



BRONCO Kit de reparación escobillas



€
168

€
38

€
18

		MOTOR COMPLETO		REPARACIÓN
ARCTIC CAT	Año	Ref. Original	Referencia	Referencia
250	99-05	3545-003	DAT01116	DAT01162
300	98-05	3545-003	DAT01116	DAT01162
400	03-13	3545-016	DAT01117	
550	09-15	0825-011/13/14	DAT01814	
650	08-11	0825-011/13/14	DAT01814	
700	09-15	0825-011/13/14	DAT01814	
1000	08-12	0825-011/13/14	DAT01814	

		MOTOR COMPLETO		REPARACIÓN
CAN AM	Año	Ref. Original	Referencia	Referencia
Outlander 500	07-14	420-684-560	DSM01305	
Renegade 500	08-09	420-684-560	DSM01305	
Outlander 650	06-13	420-684-560	DSM01305	
Commander 800	11-14	420-684-560	DSM01305	
Outlander 800	06-14	420-684-560	DSM01305	
Renegade 800	07-14	420-684-560	DSM01305	
Commander 1000	11-14	420-684-560	DSM01305	
Outlander 1000	2013	420-684-560	DSM01305	
Renegade 1000	12-14	420-684-560	DSM01305	

		MOTOR COMPLETO		REPARACIÓN
HONDA	Año	Ref. Original	Referencia	Referencia
TRX 250 Recon	97-07	31200-HN8-003		DAT01145
TRX 250 Sportrax	01-14	31200-HN8-A41		DAT01145
TRX 300	88-00	31200-HC4-033	DAT01069	DAT01145
TRX 300 Sportrax	93-09			DAT01153
TRX 350 Rancher	00-06	31200-HN5-671	DAT01127	DAT01164
TRX 400 Sportrax	99-14	31200-HN1-000	DAT01121	DAT01163
TRX 400 Foreman	95-01			DAT01145
TRX 400 Foreman	02-03			DAT01164
TRX 450 Foreman	98-01			DAT01145
TRX 450 Foreman	02-04			DAT01164
TRX 450 R Sportrax	06-14	31201-MBE-008		DMX01254
TRX 500 Rubicon	04-14	31200-HN2-A01	DAT01102	DAT01145
TRX 500 Foreman	05-11	31200-HMY-A41	DAT01102	DAT01164
TRX 650 Rubicon	03-05	31200-HN8-003	DAT01112	DAT01167
TRX 680 Rincon	06-16	31200-HN8-003	DAT01112	DAT01167

		MOTOR COMPLETO		REPARACIÓN
KAWASAKI	Año	Ref. Original	Referencia	Referencia
KFX 80	03-06	21163-S003	DAT01077	
KLF 400 Bayou	93-99	21163-1208	DAT01108	DAT01145
KVF 400 Prairie	97-02	21163-1208	DAT01108	DAT01145
KVF 650 Prairie	02-03	21163-0037	DAT01120	
KVF 650 Brute Force	05-13	21163-0037	DAT01120	
KVF 650i Brute Force	06-13	21163-0037	DAT01120	
KVF 700 Prairie	04-06	21163-0037	DAT01120	
KFX 700	04-09	21163-1320	DAT01120	
KVF 750 Brute Force	05-15	21163-1320	DAT01120	
KRF 750 Teryx	08-15	21163-1320	DAT01120	

		MOTOR COMPLETO		REPARACIÓN
KTM	Año	Ref. Original	Referencia	Referencia
450 SX	09-10	77340001000	DMX01304	
505 SX	2010	77340001000	DMX01304	

		MOTOR COMPLETO		REPARACIÓN
POLARIS	Año	Ref. Original	Referencia	Referencia
Trail Blazer 250	03-06	3085393	DAT01067	DAT01142
300	94-95	3084403	DAT01067	DAT01142
XPlorer 300	96-99	3085393	DAT01067	DAT01142
XPress 300	96-99	3085393	DAT01067	DAT01142
Magnum 325	00-02	3084981	DAT01106	DAT01156
Trail Boss 325	00-02	3084981	DAT01106	DAT01156

Magnum 330	03-06	3084981	DAT01106	DAT01156
Trail Blazer 330	08-11	3084981	DAT01106	DAT01156
Trail Boss 330	03-11	3084981	DAT01106	DAT01156
Sportsman 335	99-00	3084981	DAT01106	DAT01156
Worker 335	1999	3084981	DAT01106	DAT01156
Trail Blazer 350	08-09	3084981	DAT01106	DAT01143
400 L	94-95	3084403	DAT01067	
Scrambler 400	95-02	3084403	DAT01067	DAT01142
Sport 400	94-99	3084403	DAT01067	DAT01142
Sportsman 400	94-97	3084403	DAT01067	DAT01142
Sportsman 400	01-05	3084981	DAT01106	DAT01156
Trail Blazer 400	2003	3085393	DAT01067	DAT01142
XPlorer 400	95-02	3084403	DAT01067	DAT01142
XPress 400	96-97	3084403	DAT01067	DAT01142
Sportsman 450	06-07	3084981	DAT01106	DAT01156
Magnum 500	99-03	3084981	DAT01106	DAT01156
Outlaw 500	06-07			DAT01156
Scrambler 500	97-12	3084981	DAT01106	DAT01156
Sportsman 500	96-12	3084981	DAT01106	DAT01156
Predator 500	03-07			DAT01143
Worker 500	1999	3084981	DAT01106	DAT01156
XPlorer 500	1997	3084981	DAT01106	DAT01156
Sportsman 600	03-05		DAT01103	DAT01167
Ranger 700	07-09		DAT01103	DAT01167
Sportsman 700	04-08		DAT01103	DAT01167
Sportsman 800	05-14		DAT01103	DAT01167
RZR 800	08-09		DAT01103	DAT01167
RZR 900	11-12	4013059	DAT01807	

		MOTOR COMPLETO		REPARACIÓN
SUZUKI	Año	Ref. Original	Referencia	Referencia
LT 80	87-06	31100-40B01	DAT01077	DAT01139
LT-F 160 Quadrunner	91-99	31100-02C02	DAT01128	DAT01145
LT-F 160 Quadrunner	00-04			DAT01145
LT-F 250 Ozark	02-14	31100-19B11	DAT01116	DAT01145
LT-F 250 Quadrunner	88-09	31100-19B11	DAT01116	DAT01145
LT-Z 250	04-09			DAT01145
LT-F 300 King Quad	99-02	31100-19B20	DAT01116	DAT01145
LT-A 400 Eiger	02-07	31100-38F00	DAT01117	DAT01179
LT-A 400 King Quad	08-10	31100-38F00	DAT01117	DAT01179
LT-F 400 King Quad	08-10	31100-38F00	DAT01117	DAT01179
LT-F 400 Ozark	02-09			DAT01145
LT-A 450 King Quad	07-10		DAT01104	
LT-A 500	98-06			DAT01162
LT-A 500 King Quad	09-14		DAT01104	
LT-V 700 Twin Peaks	04-05	K2116-31320	DAT01120	DAT01162
LT-A 700 King Quad	05-07			DAT01162
LT-A 750 King Quad	08-09			DAT01162

		MOTOR COMPLETO		REPARACIÓN
YAMAHA	Año	Ref. Original	Referencia	Referencia
YFM 50 Raptor	04-09	55X-81800-51	DAT01075	DAT01172
YFM 80 Badger	86-01	55X-81800-51	DAT01075	DAT01172
YFM 80 Grizzly	05-08	55X-81800-51	DAT01075	DAT01172
YFM 80 Raptor	02-08	55X-81800-51	DAT01075	DAT01172
YFM 100 Champ	90-91	55X-81800-51	DAT01075	DAT01172
YFA 125 Breeze	95-04	3FA-81800-01	DAT01114	DAT011351
YFM 125 Grizzly	04-13	3FA-81800-01	DAT01114	DAT011351
YFM 250 Bear Tracker	99-04	4XE-81890-00	DAT01107	DAT01133
YFM 250 Big Bear	07-11	5XG-H1800-00	DAT01076	
YFM 250 Bruin	05-06	5XG-H1800-00	DAT01076	
YFB 250 Timberwolf	92-98	4BD-81800-00	DAT01107	DAT01133
YFM 350 Big Bear	89-99	2HR-81800-52	DAT01122	DAT01141
YFM 350 R Raptor	04-13	1UY-81890-00	DAT01066	DAT01056
YFM 350 Warrior	90-01	1UY-81800-51	DAT01066	DAT01056
YFM 350 Warrior	02-04	1UY-81890-00	DAT01066	DAT01056
YFM 350 Wolverine	96-05	4KB-81800-00	DAT01122	DAT01141
YFM 350 Wolverine	06-09	3HE-81890-00		
YFM 400 Big Bear Pro	02-03	1UY-81890-00	DAT01066	DAT01130
YFM 400 Kodiak	93-98	2HR-81800-52	DAT01066	DAT01130
YFM 400 Kodiak	1999	4KB-81800-00	DAT01122	DAT01141
YFM 400 Kodiak Autom.	00-02	4WV-81890-00	DAT01113	

YFM 400 Kodiak Autom.	03-06	5KM-81890-00	DAT01113	DAT01054
YFM 450 Grizzly	07-10	5KM-81890-00	DAT01113	DAT01054
YFM 450 Kodiak	03-06	5KM-81890-00	DAT01113	DAT01054
YFM 450 Wolverine	06-10	5KM-81890-00	DAT01113	DAT01054
YXR 450 Rhino	06-08	5KM-81890-00	DAT01113	DAT01054
YFM 550 Grizzly	09-10	1S3-81890-00		DAT01054
YFM 600 Grizzly	98-01	4VV-81890-00	DAT01113	DAT01054
YFM 660 Grizzly	02-08	5KM-81890-00	DAT01113	DAT01054
YFM 660 Raptor	01-05	3SX-81890-00	DAT01109	DAT01167

YXR 660 Rhino	04-07	5KM-81890-00	DAT01113	DAT01155
YFM 700 Grizzly	07-08	1S3-81890-00		DAT01054
YFM 700 Grizzly	09-14	28P-81890-00	DAT01086	DAT01054
YFM 700 Raptor	06-14	1S3-81890-00		DAT01054
YXR 700 Rhino	08-13	1S3-81890-00	DAT01113	DAT01054

RUEDAS Y NEUMÁTICOS

MOTOR

ADMISIÓN / ESCAPE REFRIGERACIÓN

ELÉCTRICO

SUSPENSIÓN / DIRECCIÓN

FRENOS

TRANSMISIÓN

CONTROLES Y MANDOS

CHASIS

ACCESORIOS

BRONCO Kit escobillas STD

Kit estándar de dos escobillas para motor de arranque.

Referencia	Descripción	€
DAT01171	9,7mm de ancho x 5,8mm de grosor x 12,1mm de largo	12,98

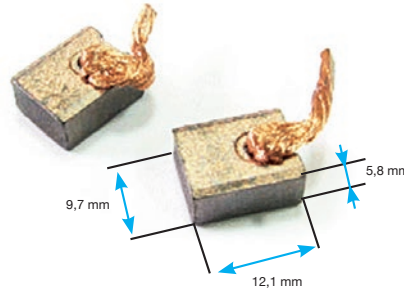

BRONCO Bendix Polaris

Referencia	Descripción	€
DAT01068	Hasta 500cc 2 y 4t.	61,56
DAT01150		98,00



Pipas de bujía



Referencia	Descripción	€
E28-47800	Silicona	1,25



Referencia	Descripción	€
D0110904	Tipo NGK	2,22



Referencia	Descripción	€
D01110B	Con cable 50cm	3,90



Referencia	Descripción	€
D0110924	Silicona con resistencia	5,99



Referencia	Descripción	€
D0110923	Silicona con resistencia	5,99



Referencia	Descripción	€
XMC12227	Funda de bujía	2,95

BRONCO Bobina encendido



CAN AM	Año	Referencia	€
Traxter	03-10	DSM01149	118,80
Outlander 500	09-15	DSM01149	118,80
Renegade 500	09-15	DSM01149	118,80
Outlander 650	09-15	DSM01149	118,80
Commander 800	11-15	DSM01149	118,80
Outlander 800	09-10	DSM01149	118,80
Renegade 800	09-13	DSM01149	118,80
Commander 1000	11-15	DSM01149	118,80
Maverick 1000	14-15	DSM01149	118,80
Outlander 1000	12-15	DSM01149	118,80
Renegade 1000	12-15	DSM01149	118,80

HONDA	Año	Referencia	€
TRX 250 R	86-89	DAT01300	27,89
TRX 250 D Recon	97-01	DAT01300	27,89
TRX300EX	93-06	DAT01300	27,89
TRX350 FE / FM / TE / TM Rancher	00-06	DAT01300	27,89
TRX400EX	99-06	DAT01311	42,90
TRX400FW	95-03	DAT01300	27,89
TRX450FE/FM	98-04	DAT01300	27,89

KAWASAKI	Año	Referencia	€
KLF 300 Bayou 2X4	86-04	DAT01314	47,61
KLF 300 Bayou 4X4	89-96	DAT01314	47,61
KLF 300 Bayou 4X4	97-04	DAT01315	46,12
KVF 360 Prairie	03-12	DAT01316	31,96
KVF 650 Prairie 4X4	02-03	DAT01316	31,96
KVF 650 Brute Force 4x4	05-13	DAT01316	31,96
KVF 700 Prairie 4x4	04-06	DAT01316	31,96

POLARIS	Año	Referencia	€
250 Trail Blazer	99-03	DAT01319	33,03
250 Trail Boss	88-98	DAT01319	33,03
330 ATP	03-06	DAT01344	23,60
330 Magnum	03-05	DAT01344	23,60
330 Trail Blazer	08-13	DAT01344	23,60
330 Trail Boss	02-13	DAT01344	23,60
335 Sportsman	1999	DAT01319	33,03
335 Worker	1999	DAT01319	33,03
350 L	1993	DAT01319	33,03
400 L	94-95	DAT01319	33,03
400 Hawkeye	11-14	DAT01319	33,03
400 Scrambler	97-02	DAT01319	33,03
400 L Sport	94-99	DAT01319	33,03
400 Ranger	10-14	DAT01319	33,03
400 Sportsman	97-14	DAT01319	33,03
400 Trail Blazer	2003	DAT01319	33,03
425 Xpedition	00-02	DAT01319	33,03
500 Magnum	00-03	DAT01319	33,03
ATP 500	2004	DAT01319	33,03
500 Magnum	95-02	DAT01319	33,03
500 Predator	03-07	DAT01305	33,03
500 Ranger	04-11	DAT01319	33,03
500 Scrambler	95-11	DAT01319	33,03
500 Sportsman	96-13	DAT01319	33,03
700 Ranger	05-09	DSM01149	118,80
700 Sportsman	04-08	DSM01149	118,80
800 Ranger	10-15	DSM01149	118,80
800 RZR	08-14	DSM01149	118,80
800 RZR S	12-14	DSM01149	118,80

800 RZR 4	12-14	DSM01149	118,80
800 Sportsman	07-13	DSM01149	118,80
850 Sportsman	09-15	DSM01149	118,80
900 Ranger	12,15	DSM01149	118,80
900 RZR	11-15	DSM01149	118,80
900 RZR 4	14-15	DSM01149	118,80
1000 RZR XP	14-15	DSM01149	118,80
1000 RZR XP 4	14-15	DSM01149	118,80
1000 Sportsman	14-15	DSM01149	118,80
1000 Scrambler	14-15	DSM01149	118,80

SUZUKI	Año	Referencia	€
LT 160	89-04	DAT01318	30,46
LT 250 R Quad Racer	87-91	DAT01318	30,46
LT 500 R Quad Racer	87-89	DAT01318	30,46
LT-Z 400 Quad Sport	03-08	DAT01318	30,46
LT-A 450 King Quad	07-10	DAT01318	30,46
LT-F 500 Quad Runner	98-02	DAT01318	30,46
LT-A 500 King Quad	09-14	DAT01318	30,46
LT-A 500 Vinson	02-07	DAT01318	30,46
LT-F 500 Vinson	04-07	DAT01318	30,46
LT-A 700 King Quad	05-07	DAT01318	30,46
LT-F 750 King Quad	08-13	DAT01318	30,46

YAMAHA	Año	Referencia	€
YFM 50 R Raptor	04-06	DAT01318	30,46
YFM 80 Badged	00-01	DAT01318	30,46
YFM 80 Grizzly	2006	DAT01318	30,46
YFM 80 Raptor	02-06	DAT01318	30,46
YFA1 125 Breeze	99-04	DAT01318	30,46
YFM 125 Grizzly	05-06	DAT01318	30,46
YFS 200 Blaster	95-96	DAT01307	31,96
YFS 200 Blaster	97-06	DAT01308	30,46
YFM 250 Beartracker	99-04	DAT01318	30,46
YFM 250 Bruin	05-06	DAT01318	30,46
YFM 250 Big Bear	07-09	DAT01318	30,46
YFB 250 Timberwolf	95-00	DAT01308	30,46
YFM 350 Big Bear	95-98	DAT01308	30,46
YFM 350 Big Bear	1999	DAT01318	30,46
YFM 350 Banshee	95-06	DAT01309	88,90
YFM 350 Raptor	04-13	DAT01318	30,46
YFM 350 Warrior	89-01	DAT01308	30,46
YFM 350 Warrior	02-04	DMX01002	23,89
YFM 350 Wolverine	96-01	DAT01308	30,46
YFM 400 Kodiak semiauto.	97-98	DAT01308	30,46
YFM 400 Kodiak	99-06	DAT01318	30,46
YFM 400 Grizzly	07-08	DAT01318	30,46
YFM 450 Grizzly	07-14	DAT01318	30,46
YFM 450 Kodiak	03-06	DAT01318	30,46
YFM 450 Wolverine	06-10	DAT01318	30,46
YFM 550 Grizzly	08-15	DAT01346	29,92
YFM 600 Grizzly	98-00	DAT01318	30,46
YFM 660 Grizzly	01-06	DAT01318	30,46
YFM 660 Raptor	01-05	DAT01318	30,46
YXR 660 Rhino	04-07	DAT01347	30,80
YFM 700 Grizzly	2007	DAT01343	31,96
YFM 700 Grizzly	08-15	DAT01346	29,92
YFM 700 Raptor	06-15	DAT01343	31,96
YXR 700 Rhino	08-13	DAT01347	30,80
YXM 700 Viking	14-17	DAT01347	30,80



Bujías NGK

El modelo de bujía puede tener opcionales según año y versión del vehículo.



ARCTIC CAT	Referencia	€
1000 ATV	CPR8E	10,14
CAN AM	Referencia	€
Rally 200	BR9ECS	10,14
DS 250	CR8E	10,14
Outlander 330	DCPR8E	8,38
Outlander 330 (Rotax)	BR9ECS	10,14
Outlander 400	BR9ECS	10,14
Outlander 400 (Rotax)	DCPR8E	8,38
DS 450	DCPR9E	8,38
Outlander 450	LMAR8D-J	
Outlander 500	DCPR8E	8,38
Renegade 500	DCPR8E	8,38
Traxter 500	DR8EA	4,84
Traxter 500 (Rotax)	BR9ECS	10,14
Renegade 570	DCPR8E	8,38
DS 650	DR8EA	4,84
Outlander 650	DCPR8E	8,38
Traxter 650	DR8EA	4,84
Quest 650	BR9ECS	10,14
Outlander 800	DCPR8E	8,38
Renegade 800	DCPR8E	8,38
Commander 800	DCPR8E	8,38
Outlander 850	LMAR8D-J	
Renegade 850	LMAR8D-J	
Outlander 1000	DCPR8E	8,38
Renegade 1000	DCPR8E	8,38
Commander 1000	DCPR8E	8,38
Maverick 1000 Xrs Xcc	LMAR8C-9	10,67
Maverick 1000 Turbo	LMAR9D-J	16,86
GAS GAS	Referencia	€
Wild 300	BR8EG	10,14
Wild 450	CR8E	10,14
HONDA	Referencia	€
TRX 250 EX Sportrax	DPR8EA-9	4,84
TRX 250 Recon	DPR8EA-9	4,84
TRX 300 EX Sportrax	DR8ESL	4,84
TRX 350 Rancher	DPR7EA-9	4,84
TRX 400 Sportrax	DPR8Z	10,14
TRX 400 Foreman / Rancher	DPR7EA-9	4,84
TRX 400 Rancher	DPR8EA-9	4,84
TRX 450 Foreman	DPR7EA-9	4,84
TRX 450 R	DPR7EA-9	4,84
KAWASAKI	Referencia	€
KLF 220 Bayou	DR8ES	4,84
KLF 250 Bayou	DR8ES	4,84
KSF 250 Mojave	DPR8EA-9	4,84
KEF 300 Lakota	DR7EA	4,71
KLF 300 Bayou	DR7EA	4,71
KVF 300 Brute Force	DR8EA	4,84
KVF 300 Prairie	DR8EA	4,84
KVF 360 Prairie	DPR8EA-9	4,84
KFX 400	CR7E	10,14
KLF 400 Bayou	DPR8EA-9	4,84
KVF 400 Prairie	DPR8EA-9	4,84
KVF 650 Brute Force	CR7E	10,14
KVF 650i Brute Force	CR7E	10,14
KVF 650 Prairie	CR7E	10,14
KFX 700 V-Force	CR7E	10,14
KVF 700 Prairie	CR7E	10,14
KVF 750i Brute Force	CR7E	10,14

KYMCO	Referencia	€
Mxer 50	BR8HSA	4,71
Mxer 150	DR8EA	4,84
KXR 250	DPR7EA-9	4,84
MXU 250	DPR7EA-9	4,84
Maxxer 300	DPR7EA-9	4,84
MXU 400	CR8E	10,14
MXU 500	CR8E	10,14

KTM	Referencia	€
SX 450	CR9EKB	14,83
XC 450	CR9EKB	14,83
SX 505	CR9EKB	14,83
XC 525	DCPR8E	8,38

POLARIS	Referencia	€
200 Phoenix	CR7HSA	4,71
250 Trail Blazer	BR8ES	4,84
250 Trail Boss	BR8ES	4,84
300 Hawkeye	BR8ES	4,84
300 Sportsman	BR8ES	4,84
300 Trail Boss	BR8ES	4,84
330 Trail Boss	BKR6ES	
335 Sportsman	BKR7E	5,31
400 Hawkeye	BR8ES	4,84
400 Scrambler	BR8ES	4,84
400 Sportsman	BKR5ES	4,63
400 Trail Blazer	BR8ES	4,84
400 Xplorer	BR8ES	4,84
400 Xpree	BR8ES	4,84
425 Xpedition	BKR5ES	4,63
450 Sportsman Eps	MR7F	
500 Magnum	BKR5ES	4,63
500 Outlaw	DCPR8E	8,38
500 Predator	DCPR8E	8,38
500 Ranger	BKR5ES	4,63
500 Scrambler	BKR5ES	4,63
500 Sportsman	BKR5ES	4,63
500 Xplorer	BKR5ES	4,63
525 Outlaw	DCPR8E	8,38
570 Sportsman Xp	CPR8E	10,14
800 RZR	BKR7E	5,31
800 Sportsman	CPR8E	10,14
850 Scrambler	CPR8E	10,14
850 Sportsman Xp	CPR8E	10,14
900 RZR	CPR8E	10,14
900 Sportsman	CPR8E	10,14
1000 RZR	CPR8E	10,14
1000 RZR Turbo	CPR8E	10,14
1000 Scrambler	CPR8E	10,14

SUZUKI	Referencia	€
LTF 160 Quadrunner	DPR7EA-9	4,84
LT 230 Quadrunner	DR7EA	4,71
LT-F 250 Ozark	DR7EA	4,71
LT-Z 250 Quadsport	DR8EA	4,84
LT 300 Quadrunner	DR8EA	4,84
LT-F 300 King Quad	DR7EA	4,71
LT-A 400 Eiger	CR7E	10,14
LT-A 400 King Quad	CR7E	10,14
LT-Z 400 Quadsport	CR7E	10,14
LT-A 450i King Quad	CR7E	10,14
LT-R 450	CR8EB	10,14
LT-A 500 King Quad	CR7E	10,14
LT-A 500 Quadrunner	CR7E	10,14
LT-A 500 Vinson	CR7E	10,14
LT-F 500 Quadrunner	CR7E	10,14
LT-A 550 King Quad	CR7E	10,14
LT-A 700 King Quad	CR8E	10,14
LT-V 700 Twin Peaks	CR7E	10,14
LT-A 750i King Quad	CR7E	10,14

YAMAHA	Referencia	€
YFA 125 Breeze	CR7HSA	4,71
YFM 125 Grizzly	CR7HSA	4,71
YFS 200 Blaster	BR8ES	4,84
YFM 250 Bear Tracker	DR7EA	4,71
YFM 250 Big Bear	DR7EA	4,71
YFM 250 Bruin	DR7EA	4,71
YFM 250 Raptor	DR7EA	4,71
YFM 300 Grizzly	DPR7EA-9	4,84
YFM 350 Big Bear	DR8EA	4,84
YFM 350 Bruin	DR8EA	4,84
YFM 350 Grizzly	DR8EA	4,84
YFM 350 Raptor	DR8EA	4,84
YFM 350 Warrior	DR8EA	4,84
YFM 350 Wolverine	DR8EA	4,84
YFZ 350 Banshee	BR8ES	4,84
YFM 400 Big Bear	DR8EA	4,84
YFM 400 Grizzly	DR8EA	4,84
YFM 400 Kodiak	DR8EA	4,84
YFM 450 Grizzly	DR8EA	4,84
YFM 450 Kodiak	DR8EA	4,84
YXR 450 Rhino	DR8EA	4,84
YFM 450 Wolverine	DR8EA	4,84
YFZ 450	CR8E	10,14
YFZ 450 R	CR8E	10,14
YFM 550 Grizzly	LMAR6A-9	24,53
YFM 600 Grizzly	DPR8EA-9	4,84
YFM 660 Grizzly	DPR8EA-9	4,84
YFM 660 Raptor	DPR8EA-9	4,84
YXR 660 Rhino	DPR8EA-9	4,84
YFM 700 Grizzly	CPR7EA-9	10,14
YFM 700 Kodiak	CPR7EA-9	10,14
YFM 700 Raptor	CR8E	10,14
YXE 700 Wolverine	CPR7EA-9	10,14
YXR 700 Rhino	CPR7EA-9	10,14
YXM 700 Viking	CPR7EA-9	10,14
YXZ 1000	CR9EB	

RUEDAS Y NEUMÁTICOS

MOTOR

ADMISIÓN / ESCAPE
REFRIGERACIÓN

ELÉCTRICO

SUSPENSIÓN / DIRECCIÓN

FRENOS

TRANSMISIÓN

CONTROLES Y MANDOS

CHASIS

ACCESORIOS

BRONCO Regulador de corriente

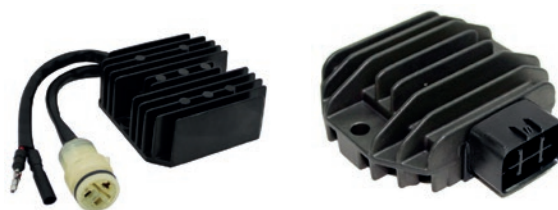

ARCTIC CAT					
Año	Referencia	Tipo	Ref. Original	€	
375 auto	2002	DAT01219	ORIGINAL	3530-028/3530-059/3402-682 (SUZUKI#32800-44D31)	98,63
400 todos	02-08	DAT01219	ORIGINAL	3530-028/3530-059/3402-682 (SUZUKI#32800-44D31)	98,63
400 DVX	04-06	DAT01215	ORIGINAL	3530-028/3530-059/3402-682 (SUZUKI#32800-44D31)	90,75
500 todos	02-09	DAT01219	ORIGINAL	3530-028/3530-059/3402-682 (SUZUKI#32800-44D31)	98,63
CAN AM					
Año	Referencia	Tipo	Ref. Original	€	
Outlander 330	05-10	DSM01120	ORIGINAL	710000908/ 710000261/ 710001103	171,20
Outlander 400	03-15	DSM01120	ORIGINAL	710000908/ 710000261/ 710001103	171,20
Outlander 450	2015	DSM01120	ORIGINAL	710000908/ 710000261/ 710001103	171,20
Outlander 500	08-14	DSM01120	ORIGINAL	710000908/ 710000261/ 710001103	171,20
Renegade 500	08-15	DSM01120	ORIGINAL	710000908/ 710000261/ 710001103	171,20
Outlander 650	08-15	DSM01120	ORIGINAL	710000908/ 710000261/ 710001103	171,20
Outlander 800	08-15	DSM01120	ORIGINAL	710000908/ 710000261/ 710001103	171,20
Renegade 800	08-15	DSM01120	ORIGINAL	710000908/ 710000261/ 710001103	171,20
Outlander 1000	12-14	DSM01120	ORIGINAL	710000908/ 710000261/ 710001103	171,20
Renegade 1000	12-15	DSM01120	ORIGINAL	710000908/ 710000261/ 710001103	171,20
HONDA					
Año	Referencia	Tipo	Ref. Original	€	
TRX 250 EX Sportrax	99-05	DAT01212	ALTO RENDIMIENTO	31600-HM8-013 (00-05)	93,75
TRX 250 Recon	97-06	DAT01212	ALTO RENDIMIENTO	31600-HM8-013 (97-04)	93,75
TRX 300 EX Sportrax	93-06	DAT01213	ALTO RENDIMIENTO	31600-HM3-003, 31600-HM3-901	98,63
TRX 350 Rancher	00-06	DAT01226	ORIGINAL	31600-HN5-671	128,25
TRX 400 EX Sportrax	99-04	DAT01212	ALTO RENDIMIENTO	31600-HM8-013 (99-04),	93,75
TRX 400 EX Sportrax	05-14	DAT01212	ALTO RENDIMIENTO	31600-HN1-A41 (05-09)	93,75
TRX 400 Foreman	95-03	DAT01226	ORIGINAL	31600-HN5-671	128,25
TRX 420 Rancher	07-14	DAT01211	ORIGINAL	31600-HP5-601	90,16
TRX 450 Foreman	98-01	DAT01226	ORIGINAL	31600-HN5-671	128,25
TRX 450 R	04-05	DAT01226	ORIGINAL	31600-HN5-671	128,25
TRX 500 Foreman	05-11	DAT01227	ORIGINAL	31600-HP0-A01	158,24
TRX 500 Rubicon	05-09	DAT01227	ORIGINAL	31600-HP0-A01	158,24
TRX 650 Rincon	03-05	DAT01227	ORIGINAL	31600-HP0-A01	158,24
TRX 680 Rincon	06-14	DAT01227	ORIGINAL	31600-HP0-A01	158,24
E-TON					
Año	Referencia	Tipo	Ref. Original	€	
Lightning 50	00-01	DAT01079	ORIGINAL	N/A	31,32
Viper 50	02-04	DAT01079	ORIGINAL	N/A	31,32
Viper 70 todos	04-07	DAT01079	ORIGINAL	N/A	31,32
Sierra 90	00-05	DAT01079	ORIGINAL	N/A	31,32
Thunder 90	00-01	DAT01079	ORIGINAL	N/A	31,32
Viper 90 todos	02-07	DAT01079	ORIGINAL	N/A	31,32
KAWASAKI					
Año	Referencia	Tipo	Ref. Original	€	
KLF 300 Bayou	98-04	DAT01214	ALTO RENDIMIENTO	21066-1112	68,25
KVF 360 Prairie	03-12	DAT01214	ALTO RENDIMIENTO	21066-1112	68,25
KVF 400 Prairie	99-02	DAT01214	ALTO RENDIMIENTO	21066-1112	68,25
KFX 400	03-07	DAT01215	ALTO RENDIMIENTO	21066-S004, 21066-S011	90,75
KFX 450 R	08-14	DAT01215	ALTO RENDIMIENTO	21066-S004, 21066-S011	90,75
KVF 650 Brute Force	05-13	DAT01214	ALTO RENDIMIENTO	21066-1112	68,25
KVF 650 Prairie	02-03	DAT01214	ALTO RENDIMIENTO	21066-1112	68,25
KFX 700	04-09	DAT01214	ALTO RENDIMIENTO	21066-1112	68,25
KVF 700 Prairie	04-06	DAT01214	ALTO RENDIMIENTO	21066-1112	68,25
KAF 620 Mule 3000	01-08	DSM01118	ORIGINAL	21066-1127	96,15
KAF 620 Mule 3010	01-08	DSM01118	ORIGINAL	21066-1127	96,15
KAF 620 Mule 3020	01-03	DSM01118	ORIGINAL	21066-1127	96,15
KYMCO					
Año	Referencia	Tipo	Ref. Original	€	
Mongoose 250	03-07	DAT01214	ORIGINAL	N/A	68,25
Mongoose 300	06-07	DAT01214	ORIGINAL	N/A	68,25
MXU 150	04-07	DAT01214	ORIGINAL	N/A	68,25
MXU 250	05-07	DAT01214	ORIGINAL	N/A	68,25
MXU 300	06-07	DAT01214	ORIGINAL	N/A	68,25

BRONCO Regulador de corriente

POLARIS	Año	Referencia	Tipo	Ref. Original	€
Outlaw 50	08-15	DAT01079	ORIGINAL	0453479	31,32
Predator 50	04-07	DAT01079	ORIGINAL	0453479	31,32
Scrambler 50	01-03	DAT01079	ORIGINAL	0453479	31,32
Predator 90	03-07	DAT01079	ORIGINAL	0453479	31,32
Scrambler 90	01-03	DAT01079	ORIGINAL	0453479	31,32
Sportsman 90	01-14	DAT01079	ORIGINAL	0453479	31,32
Phoenix 200	04-07	DAT01203	ORIGINAL	0453025	73,80
Trail Blazer 250	90-01	DAT01228	ORIGINAL	4060208	60,75
Xpress 300	96-97	DAT01229	ORIGINAL	4060133	63,75
Magnum 325	98-02	DAT01229	ORIGINAL	4060191	63,75
Sportsman 335	99-00	DAT01229	ORIGINAL	4060191	63,75
Xpedition 325	00-02	DAT01229	ORIGINAL	4060191	63,75
Scrambler 400	95-99	DAT01228	ORIGINAL	4060208	60,75
Sportsman 400	96-97	DAT01229	ORIGINAL	4060133	63,75
Sportsman 400	01-02	DAT01229	ORIGINAL	4060191	63,75
Xplorer 400	96-02	DAT01229	ORIGINAL	4060191	63,75
Xpress 400	96-97	DAT01229	ORIGINAL	4060133	63,75
Magnum 425	96-97	DAT01229	ORIGINAL	4060133	63,75
Xpedition 425	00-02	DAT01229	ORIGINAL	4060191	63,75
Magnum 500	99-01	DAT01231	ORIGINAL	4060173 (Supersede: 2203636)	64,05
Scrambler 500	97-02	DAT01231	ORIGINAL	4060173 (Supersede: 2203636)	64,05
Sportsman 500	96-97	DAT01229	ORIGINAL	4060133	63,75
Sportsman 500	00-01	DAT01231	ORIGINAL	4060173 (Supersede: 2203636)	64,05
Worker 500	98-02	DAT01231	ORIGINAL	4060173 (Supersede: 2203636)	64,05
Sportsman 700	02-03	DAT01231	ORIGINAL	4060173 (Supersede: 2203636)	64,05
RZR 800	11-14	DAT01227	ORIGINAL	4012941	

SUZUKI	Año	Referencia	Tipo	Ref. Original	€
LT-F 160	91-04	DAT01232	ORIGINAL	32800-19B11	80,55
LT-F 250 Quadrunner	88-02	DAT01232	ORIGINAL	32800-19B11	80,55
LT-F 250 Ozark	02-15	DAT01215	ALTO RENDIMIENTO	32800-05F10/20, Kawasaki 21066-S004, 21066-S011	90,75
LT-Z 250	04-09	DAT01215	ALTO RENDIMIENTO	32800-05F10/20, Kawasaki 21066-S004, 21066-S011	90,75
LT-F 300 King Quad	99-02	DAT01232	ORIGINAL	32800-19B11	80,55
LT-A 400 Eiger	02-07	DAT01216		32800-38F10	90,75
LT-A 400 King Quad	08-09	DAT01216		32800-38F10	90,75
LT-Z 400	03-09	DAT01215	ORIGINAL	32800-05F10/20, Kawasaki 21066-S004, 21066-S011	72,25
LT-A 450 King Quad	07-09	DSM01118	ALTO RENDIMIENTO	32800-42F00	96,15
LT-A 500 King Quad	09-14	DSM01118	ALTO RENDIMIENTO	32800-42F00	96,15
LT-A 500 Vinson	02-09	DSM01118	ALTO RENDIMIENTO	32800-42F00	96,15
LT-A 500 King Quad	98-01	DAT01217	ORIGINAL	32800-33E00	94,05
LT-F 500 Y/K1/K2	98-02	DAT01219	ORIGINAL	32800-44D20/21, 32800-44D30/31	98,63
LT-A 700 King Quad	06-07	DSM01118	ALTO RENDIMIENTO	32800-42F00	96,15
LT-V 700 Twin Peaks	04-05	DAT01214			68,25
LT-A 750 King Quad	08-13	DSM01118	ALTO RENDIMIENTO	32800-42F00	96,15

YAMAHA	Año	Referencia	Tipo	Ref. Original	€
YFM 125 Grizzly	04-13	DAT01216	ALTO RENDIMIENTO	5GT-81960-00-00	90,75
YFS 200 Blaster	86-06	D0115432	ORIGINAL	82F-81910-A0-00	28,98
YFM 250 BearTracker	01-04	DAT01216	ALTO RENDIMIENTO	5GT-81960-00-00	90,75
YFM 250 Big Bear	07-09	DAT01216	ALTO RENDIMIENTO	5GT-81960-00-00	90,75
YFM 250 Bruin	05-06	DAT01216	ALTO RENDIMIENTO	5GT-81960-00-00	90,75
YFM 250 Raptor	08-13	DAT01216	ALTO RENDIMIENTO	5GT-81960-00-00	90,75
YFM 350 Big Bear	87-94	DAT01234	ORIGINAL	59V-81960-A0-00	95,55
YFM 350 Bruin	04-06	DAT01216	ALTO RENDIMIENTO	5GT-81960-00-00	90,75
YFM 350 Grizzly	07-14	DAT01216	ALTO RENDIMIENTO	5GT-81960-00-00	90,75
YFM 350 Moto-4	90-94	DAT01234	ORIGINAL	59V-81960-A0-00	95,55
YFM 350 Raptor	04-13	DAT01216	ALTO RENDIMIENTO	5GT-81960-00-00	90,75
YFM 350 Warrior	87-95	DAT01234	ORIGINAL	59V-81960-A0-00	95,55
YFM 350 Wolverine	06-09	DAT01216	ALTO RENDIMIENTO	5GT-81960-00-00	90,75
YFZ 350 Banshee	87-06	D0115432	ORIGINAL	82F-81910-A0-00	28,98
YFM 400 Big Bear	02-12	DAT01216	ALTO RENDIMIENTO	5GT-81960-00-00	90,75
YFM 400 Grizzly	07-08	DAT01216	ALTO RENDIMIENTO	5GT-81960-00-00	90,75
YFM 400 Kodiak	00-06	DAT01216	ALTO RENDIMIENTO	5GT-81960-00-00	90,75
YFM 450 Grizzly	07-14	DSM01118	ALTO RENDIMIENTO	5BN-81960-00-00	96,15
YFM 450 Kodiak	03-06	DAT01216	ALTO RENDIMIENTO	5GT-81960-00-00	90,75
YFM 450 Wolverine	06-09	DAT01216	ALTO RENDIMIENTO	5GT-81960-00-00	90,75
YFZ 450 R	09-16	DSM01118	ALTO RENDIMIENTO	5BN-81960-00-00	96,15
YXR 450 Rhino	06-09	DSM01118	ALTO RENDIMIENTO	5BN-81960-00-00	96,15
YFM 550 Grizzly	09-14	DAT01227	ORIGINAL	1D7-81960-00-00	158,24
YFM 600 Grizzly	99-01	DAT01216	ALTO RENDIMIENTO	5GT-81960-00-00	90,75
YFM 660 Grizzly	02-08	DSM01118	ALTO RENDIMIENTO	5BN-81960-00-00	96,15
YFM 660 Raptor	01-05	DAT01216	ALTO RENDIMIENTO	5GT-81960-00-00	90,75
YXR 660 Rhino	04-07	DSM01118	ALTO RENDIMIENTO	5BN-81960-00-00	96,15
YFM 700 Grizzly	06-14	DAT01227	ORIGINAL	1D7-81960-00-00	158,24
YFM 700 Raptor	06-16	DSM01118	ALTO RENDIMIENTO	5BN-81960-00-00	96,15
YXE 700 Wolverine	2016	DAT01227	ORIGINAL	1D7-81960-00-00	158,24
YXM 700 Viking	14-15	DAT01227	ORIGINAL	1D7-81960-00-00	158,24
YXR 700 Rhino	08-14	DAT01227	ORIGINAL	1D7-81960-00-00	158,24

RUEDAS Y NEUMÁTICOS

MOTOR

ADMISIÓN / ESCAPE
REFRIGERACIÓN

ELÉCTRICO

SUSPENSIÓN / DIRECCIÓN

FRENOS

TRANSMISIÓN

CONTROLES Y MANDOS

CHASIS

ACCESORIOS

BRONCO Regulador de corriente universal

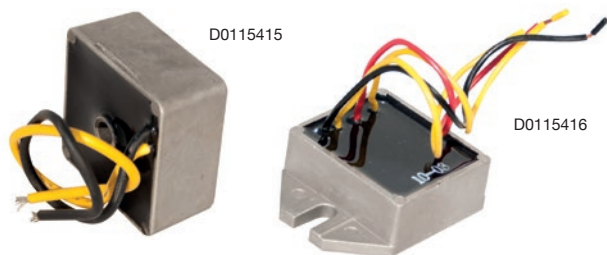

Referencia	Descripción	€
D0115415	Regulador 12V	18,10
D0115416	Regulador 12V	23,84

Adaptador regulador CAN AM

Referencia	Descripción	€
DAT01223	330 Outlander 03-04 400 Outlander 03-04	28,87



BRONCO Pickup

€
22



HONDA	Año	Cable	Referencia
TRX 200 Fourtrax	90-96		DAT01094
TRX 250 R Fourtrax	89-92		DAT01094
TRX 250 Recon	97-16		DAT01094
TRX 250 Sportrax	01-16		DAT01094
TRX 300 EX Sportrax	93-09		DAT01094
TRX 300 FW	89-95		DAT01094
TRX 350 Rancher	00-06		DAT01094
TRX 400 Foreman	95-03		DAT01094
TRX 400 Rancher	04-07		DAT01094
TRX 450 Foreman	98-04		DAT01094
TRX 500 Rubicon	01-16		DAT01094
TRX 650 Rincon	03-05		DAT01094
TRX 680 Rincon	06-14		DAT01619

KAWASAKI	Año	Cable	Referencia
KLF 220 Bayou	88-95	1170 mm	DAT01608
KLF 220 Bayou	96-02	310 mm	DAT01607
KLF 250 Bayou	03-11	310 mm	DAT01607
KLF 300 Bayou	88-04	570 mm	DAT01606
KEF 300 Lakota	95-02	570 mm	DAT01606
KVF 300 Prairie	99-02	580 mm	DAT01604
KVF 360 Prairie	03-13	110 mm	DAT01612
KVF 400 Prairie	98-02	110 mm	DAT01612
KVF 650 Brute Force	05-13	970 mm	DAT01605
KVF 650i Brute Force	06-13	970 mm	DAT01605
KVF 650 Prairie	02-03	970 mm	DAT01605
KFX 700 V-Force	04-09	970 mm	DAT01605
KVF 700 Prairie	04-09	970 mm	DAT01605
KRF 750 Teryx	08-13	970 mm	DAT01605

POLARIS	Año	Cable	Referencia
250 Trail Boss	92-99		DAT01617
250 Trail Blazer	91-06		DAT01617
335 Sportsman	99-00	50 mm	DAT01609
400 Trail Blazer	2003		DAT01617
400 Sportsman	01-04	50 mm	DAT01609
425 Magnum	95-98	50 mm	DAT01609
500 Magnum	99-03	50 mm	DAT01609
500 Ranger	06-09	50 mm	DAT01609
500 Scrambler	97-03	50 mm	DAT01609
500 Sportsman	96-04	50 mm	DAT01609
500 Xplorer	1997	50 mm	DAT01609

SUZUKI	Año	Cable	Referencia
LT-A 400 Eiger	02-07	110 mm	DAT01612
LT-A 400 King Quad	08-09	110 mm	DAT01612
LT-Z 400 QuadSport	03-09	110 mm	DAT01612
LT-R 450 Quadracer	06-09	110 mm	DAT01612

YAMAHA	Año	Cable	Referencia
YFS 200 Blaster	88-06	110 mm	DAT01611
YFM 350 Warrior	87-04	110 mm	DAT016121
YFM 350 Raptor	04-13	110 mm	DAT016121
YFM 350 Bruin	04-06	110 mm	DAT016121
YFM 350 Wolverine	06-08	110 mm	DAT016121
YFM 350 Big Bear	87-99	110 mm	DAT016121
YFM 350 Grizzly	07-14	110 mm	DAT016121
YFM 400 Grizzly	07-08	110 mm	DAT016121
YFM 400 Kodiak	03-06	110 mm	DAT016121
YFM 450 Grizzly	07-14	110 mm	DAT016121
YFM 450 Kodiak	03-06	110 mm	DAT016121
YFM 450 Wolverine	06-10	110 mm	DAT016121
YFM 660 Raptor	01-05	110 mm	DAT016121
YFM 660 Grizzly	02-08	110 mm	DAT016121
YFM 700 Raptor	06-16	110 mm	DAT016121
YXR 660 Rhino	03-07	110 mm	DAT016121



Juntas estátor



ARCTIC CAT	Año	Referencia	Referencia Original	€
400 Manual	98-02	NA30049CG	11483-44D01	5,98
400 Manual	03-08	NA30010CG2	11483-38F10	22,99
400 Auto	03-08	NA30011CG	11483-38F00	24,25
454	96-98	NA30049CG	11483-44D01	5,98
500 Manual	98-09	NA30049CG	11483-44D01	5,98
700 Auto FIS/TRV	06-08	NA30015CG5	11483-31G00-00	15,29

CAN AM	Año	Referencia	Referencia Original	€
Outlander 500	07-15		420651200	
Outlander Max 500	07-15	NA80000CG2	420651201	9,66
Renegade 500 EFI	08-15			
Outlander Max 570	2016	NA80000CG2	420651200	9,66
Renegade 570 EFI	2016		420651201	
Outlander 650	06-15		420651200	
Outlander Max 650	06-08	NA80000CG2	420651201	9,66
Outlander 800	06-15		420651200	
Outlander 800R	06-15	NA80000CG2	420651201	9,66
Outlander 800 HO	06-15			
Outlander 800 EFI	06-15			
Outlander Max 800	06-15		420651200	
Outlander Max 800 R	06-15	NA80000CG2	420651201	9,66
Outlander Max 800 HO	06-15			
Outlander Max 800 EFI	06-15			
Renegade 800	07-15	NA80000CG2	420651200	9,66
Renegade 800 R	07-15		420651201	
Commander 800 EFI	11-16		420651200	
Commander 800 R	11-16	NA80000CG2	420651201	9,66
Commander 800 STD	11-16			
Commander 800 XT	11-16			
Defender HD8	2016	NA80000CG2	420651200	9,66
Outlander 850	2016		420651200	
Outlander Max 850	2016	NA80000CG2	420651201	9,66
Renegade 850	2016			
Outlander 1000	13-16		420651200	
Outlander Max 1000	13-16	NA80000CG2	420651201	9,66
Renegade 1000	12-16			
Commander 1000	11-15		420651200	
Commander Max 1000	14-16	NA80000CG2	420651201	9,66
Maverick 1000	13-15			
Maverick Max 1000	14-16			

HONDA	Año	Referencia	Referencia Original	€
TRX 350 Rancher	00-06	NA10007CG	11396-HN5-670	5,96
TRX 400 Sportrax	93-13	NA10003CG2	11395-KCY-671 11395-KCY-672	8,54

KAWASAKI	Año	Referencia	Referencia Original	€
KVF 650 Prairie	02-03		11060-1963	
KVF 650 Brute Force	05-13	NA20070CG	11061-1119	12,21
KVF 700 Prairie	04-06		11060-1963	
KFX 700	04-09	NA20070CG	11061-1119	12,21
KVF 750 Brute Force	05-16		11060-1963	
KRF 750 Teryx	08-13	NA20070CG	11061-1119	12,21

POLARIS	Año	Referencia	Referencia Original	€
AC 900	16-17	NA50092CG	5814160	15,54
Ranger XP 900	13-17	NA50092CG	5814160	15,54
RZR XP 900	15-17	NA50092CG	5814160	15,54
RZR XP 900 "4"	15-17	NA50092CG	5814160	15,54
General 1000	16-17	NA50092CG	5814160	15,54
RZR 1000	14-17	NA50092CG	5814160	15,54
RZR 1000 Turbo	16-17	NA50092CG	5814160	15,54

SUZUKI	Año	Referencia	Referencia Original	€
LT-A 400 Eiger	02-07	NA30011CG	11483-38F00	24,25
LT-F 400 Eiger	02-07			
LT-F 400 King Quad	08-15	NA30010CG2	11483-38F10	22,99
LT-A 450 King Quad	07-10	NA30053CG2	11483-11H00	25,23
LT-A 500 King Quad				
LT-A 500 King Quad	09-15	NA30053CG2	11483-11H00	25,23
LT-F 500 Quadrunner	98-02			
LT-F 500 Vinson	03-07	NA30049CG	11483-44D01	16,74
LT-A 700 King Quad	05-07	NA30015CG5	11483-31G00-00	15,29
LT-A 750 King Quad	08-16	NA30015CG5	11483-31G00-00	15,29

YAMAHA	Año	Referencia	Referencia Original	€
YFA 125 Breeze	89-04			
YFM 125 Grizzly	04-13	NA40019CG	3FA-15461-10-00	7,53
YFB 250 Timberwolf	92-00			
YFM 250 Bear Tracker	99-04			
YFM 250 Bruin	05-06	NA40015CG2	4BD-15451-01-00	8,06
YFM 250 Big Bear	07-09			
YFM 600 Grizzly	98-01	NA40007CG	4WV-15451-00	9,49
YFM 660 Grizzly	02-08			
YXR 660 Rhino	04-07	NA40010CG	5KM-15451-00	10,02



RUEDAS Y NEUMÁTICOS

MOTOR

ADMISIÓN / ESCAPE
REFRIGERACIÓN

ELÉCTRICO

SUSPENSIÓN / DIRECCIÓN

FRENOS

TRANSMISIÓN

CONTROLES Y MANDOS

CHASIS

ACCESORIOS

Relés de arranque



Referencia	Descripción	€
DAT01097	12V 80A HONDA	20,93



Referencia	Descripción	€
DAT01098	POLARIS	20,00



Referencia	Descripción	€
DAT01100	YAMAHA Carburación	39,84



Referencia	Descripción	€
DAT01105	YAMAHA HONDA	21,55



Referencia	Descripción	€
DAT01751	HONDA	14,73



Referencia	Descripción	€
DMC01696	12V 30A SUZUKI	24,03



Referencia	Descripción	€
DAT01752	CAN AM	16,52



Referencia	Descripción	€
DAT01099		20,00



Referencia	Descripción	€
DAT01101	HONDA	

Conmutadores



Intermitentes y claxon

Referencia	Descripción	€
V1651	SUZUKI	17,14



Referencia	Descripción	€
V1650	YAMAHA	17,16



Referencia	Descripción	€
V1652	YFM 660 Raptor	33,48



Referencia	Descripción	€
V1656	Conmutador 2t	34,72



Referencia	Descripción	€
V1658	Conmutador derecho	99,96



Referencia	Descripción	€
V1660	Conmutador izquierdo	99,96



Referencia	Descripción	€
V1654	YFM 350 Warrior	53,70



Referencia	Descripción	€
V1662	Yamaha Breeze	30,76



Referencia	Descripción	€
V164	Bear Tracker	34,32

Ópticas homologadas



Óptica ATV Yamaha

Referencia	€
XT1001	28,68



Óptica deportivos

Ref.	Descripción	€
XT1010	Óptica homologada	25,36
XT1011	Óptica homologada con cable y soportes	48,76



Óptica ATV

Referencia	Descripción	€
XT1020	Sin lamparas	18,79

Pilotos homologados



Tulipa Raptor 350 / 660

Referencia	€
DAT01084E	7,63



Piloto Raptor 350 / 660

Referencia	€
DAT01085E	29,85

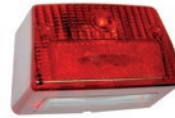

Piloto Yamaha homologado

Referencia	€
XT1101	14,20



Tulipa Yamaha homologada

Referencia	€
XT1103	8,80



450 / 525 Outlaw 09-10
850 Scrambler 13-16
1000 Scrambler 14-16

Referencia	€
DSM01503	51,48



Piloto Raptor 700
YFZ 450 (06-13)

Referencia	€
DSM01108	49,45

Intermitentes homologados



Ref.	Descripción	€
V1621	Tras. Izq. / Del. Der.	7,95
V1622	Tras. Der. / Del. Izq.	7,95



Ref.	Descripción	€
V1612	Tras. Izq. / Del. Der.	7,95
V1613	Tras. Der. / Del. Izq.	7,95



Ref.	Descripción	€
DMC01321-1	12V 10W derecha	7,95
DMC01321-2	12V 10W izquierda	7,95



Ref.	Descripción	€
DMC01331E	12V 21W Juego 2 int.	12,60



Ref.	Descripción	€
DMC013301E	12V 21W Juego 2 int.	21,84



Ref.	Descripción	€
DMC01330E	12V 21W Juego 2 int.	21,84



Ref.	Descripción	€
D15921	12V 21W Juego 2 int.	12,18



RUEDAS Y NEUMÁTICOS

MOTOR

ADMISIÓN / ESCAPE
REFRIGERACIÓN

ELÉCTRICO

SUSPENSIÓN / DIRECCIÓN

FRENOS

TRANSMISIÓN

CONTROLES Y MANDOS

CHASIS

ACCESORIOS

Soportes para ópticas, intermitentes, piloto stop



Soporte faro delantero
Raptor 700

Referencia	€
V1672	13,76



Soporte faro delantero
Raptor 350

Referencia	€
V1670	7,15



Soporte izquierdo intermitente
Raptor 700 / YFZ 450

Referencia	€
V1674	6,36



Soporte derecho intermitente
Raptor 700 / YFZ 450

Referencia	€
V1675	6,36



Soporte izquierdo intermitente
Raptor 350

Referencia	€
V1676	6,36



Soporte derecho intermitente
Raptor 350

Referencia	€
V1677	6,36

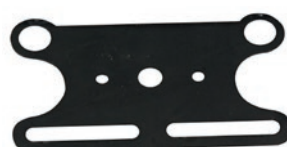

Soporte matrícula

Referencia	€
V1681	12,14

Interruptor de freno mecánico



E46-50700



DMX01006

Referencia	€
E46-50700	6,84
DMX01006	6,84



DMC01107



DAT01524



DMC01698

Referencia	Descripción	€
DAT01524	HONDA	
DMC01107	KAWASAKI	
DMC01698	YAMAHA	13,23

XPEED Interruptor de freno hidráulico



Referencia	Descripción	€
XT3100	Europa M10x100	9,90
XT3125	Japonesa M10x125	9,90



Referencia	Descripción	€
DMC01323	Japonesas M10 x 1,25	13,83
DMC013231	Europeas M10 x 1,00	13,83



Referencia	Descripción	€
DMC013282	Japonesas M10 x 1,25	13,83
DMC013283	Europeas M10 x 1,00	13,83

Varios para ITV



Discos de velocidad pequeños 10cm

Referencia	€
XT0045	12,98



Catadiópticos

Referencia	Descripción	€
XT1030	Adhesivo 75x25mm	2,88
XT1035	Atornillado 75x25mm	2,88
XT1040	Atornillado Ø60mm	2,88



Claxon

Referencia	€
XT2040	7,69



XT2010



XT2011

Relé intermitencia

Referencia	Descripción	€
XT2010	4x10W - 3 Tomas	12,44
XT2011	4x10W - 2 Tomas	12,44
XT2012	4x21W - 3 Tomas	12,72
XT2013	LEDS 12V 1/100W 2 Tomas	12,65
XT2014	LEDS 12V 1/100W 3 Tomas	13,55

Clausor



Referencia	Descripción	€
DSM01546	POLARIS	55,74

XPEED Testigos luces



Referencia	Descripción	€
V1680	Testigo intermitentes	3,50
V1681	Testigo luces cortas	3,50
V1682	Testigo luces largas	3,50

XPEED Retrovisores homologados con brida

La distancia de varilla es desde el codo hasta el espejo.

Referencia	Descripción	€
GRU15	Universal varilla 15cm	6,81
*GRD15	Universal derecho varilla 15cm	10,33
*GRI15	Universal izquierdo varilla 15cm	10,33
**GRD07	Plegable derecho	8,75
**GRI07	Plegable izquierdo	8,75



BRONCO Retrovisor UTV

Referencia	Descripción	€
DAT12193	Retrovisor central	12,99
DAT12192	Retrovisor central	12,36
DAT12583	Retrovisor central	39,96
DAT12584	Juego de retrovisores laterales	63,53



Interruptores



Referencia	Descripción	€
DUP01107	Ø 8 mm	5,35



Referencia	Descripción	€
DUP011071	Ø 8 mm	5,35



Referencia	Descripción	€
DUP01360	Ø 8 mm	5,16



Referencia	Descripción	€
XT2050	Warning	14,96



Referencia	Descripción	€
D1216604	Ø 8 mm	6,90

Toma corriente

	Referencia	€
Toma Mechero	XSM01085A	8,58
Toma USB	DUP01251	22,50



XSM01085A



DUP01251



Faros halógenos

Precio faro por 1 unidad. Faro no homologado.
*Instalación eléctrica con todo el material necesario.

Referencia	Descripción	Diámetro	Largo	€
DMP01102	A 35W Negro	45	60	12,10
DMP01102P	A 35W Cromado	45	60	9,30
DMP01103	B 50W Negro	60	65	15,80
DMP01666	C 20W Negro	35	50	7,90
DMP01666P	C 20W Cromado	35	50	7,90
DMC01633	Instalación eléctrica, relé, interruptor			13,28

BRONCO

Radiador calefacción UTV

Radiador 12V / 300W, 3 posiciones.

Referencia	€
DAT12204	76,82



EMIGO

Cables batería

Referencia	€
E84-96308	8,55



Limitador velocidad y RPM

Especialmente concebido para alquileres o niños, donde lo que se pretende es limitar la velocidad y revoluciones del vehículo.

Para ofrecer la máxima seguridad al conductor sin perjudicar el funcionamiento del motor, con un mínimo coste y rapidez.

Referencia	€
D12474	25,50



SUSPENSIÓN DIRECCIÓN



SUSPENSIÓN / DIRECCIÓN

XPEED Soporte para manillar

Referencia	Descripción	€
R510078	Para manillar de Ø 22 mm	61,05
R510118	Para manillar de Ø 28 mm	61,05



XPEED Columna dirección

€
103,25

Con la columna de dirección se precisa montar nuestro soporte de manillar.

HONDA	2 cm	4 cm	6 cm	8 cm
TRX 450R		R5330010		
KAWASAKI	2 cm	4 cm	6 cm	8 cm
KFX 400			R5330020	
SUZUKI	2 cm	4 cm	6 cm	8 cm
LTZ 400			R5330020	
LTR 450			R5330040	
YAMAHA	2 cm	4 cm	6 cm	8 cm
YFZ 450	R5330030	R5330031	R5330032	
YFZ 450R	R5330033	R5330034		
YFM 660R Raptor	R5330030	R5330031	R5330032	
YFM 660 Grizzly				R5330030
YFM 700R Raptor	R5330031	R5330032		

BRONCO Kit Reparación dirección

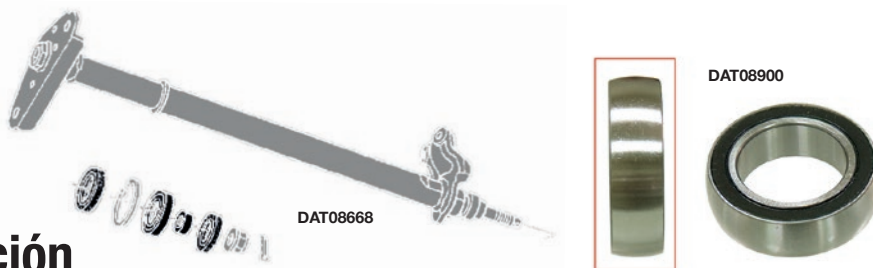

HONDA	Año	Referencia	Nº Piezas	€
TRX 90 Fourtrax	93-12	DAT08656	4	11,64
TRX 200 Fourtrax	90-96	DAT08656	4	11,64
TRX 250 EX Sportrax	01-11	DAT08656	4	11,64
TRX 250 Recon	97-12	DAT08656	4	11,64
TRX 300 EX Sportrax	93-09	DAT08662	3	11,85
TRX 300 Fourtrax	88-00	DAT08663	3	11,85
TRX 350 Rancher	00-06	DAT08663	3	11,85
TRX 400 EX Sportrax	99-09	DAT08656	4	11,64
TRX 400 Foreman/Rancher	95-07	DAT08663	3	11,85
TRX 420 Rancher	07-12	DAT08663	3	11,85
TRX 450 R	04-12	DAT08656	4	11,64
TRX 450 Foreman	98-03	DAT08663	3	11,85
TRX 500 Rubicon	01-12	DAT08665	4	20,59
TRX 650 Rincon	03-05	DAT08665	4	20,59
TRX 680 Rincon	06-12	DAT08665	4	20,59

KAWASAKI	Año	Referencia	Nº Piezas	€
KLF 250 Bayou	88-11	DAT08666		35,38
KSF 250 Mojave	04-09	DAT08666		35,38
KLF 300 Bayou	86-04	DAT08666		35,38
KLF 400 Bayou	93-99	DAT08666		35,38
KVF 400 Prairie	87-04	DAT08666		35,38
KFX 700 V-Force	04-09	DAT08666		35,38

POLARIS	Año	Referencia	Nº Piezas	€
550 Sportsman	09-13	DAT08900	1	6,98
850 Sportsman	09-13	DAT08900	1	6,98

SUZUKI	Año	Referencia	Nº Piezas	€
LT-A 450 King Quad	07-10	DAT08651		12,61
LT-R 450 Quad Sport	06-09	DAT08651		12,61
LT-A 500 King Quad	09-11	DAT08651		12,61
LT-A 700 King Quad	05-07	DAT08651		12,61
LT-A 750 King Quad	08-13	DAT08651		12,61

YAMAHA	Año	Referencia	Nº Piezas	€
YFA 125 Breeze	89-04	DAT08668	3	13,92
YFM 125 Grizzly	04-13	DAT08668	3	13,92
YFM 125 Raptor	11-12	DAT08668	3	13,92
YFS 200 Blaster	88-06	DAT08668	3	13,92
YFM 250 Raptor	08-12	DAT08668	3	13,92
YFM 350 Warrior	87-04	DAT08668	3	13,92
YFM 350 Raptor	04-13	DAT08668	3	13,92
YFZ 350 Banshee	91-06	DAT08668	3	13,92
YFM 350 Grizzly	07-14	DAT08668	3	13,92
YFZ 450	04-13	DAT08668	3	13,92
YFZ 450 R	09-16	DAT08668	3	13,92
YFM 450 Kodiak	04-06	DAT08668	3	13,92
YFM 450 Grizzly	07-12	DAT08668	3	13,92
YFM 550 Grizzly	09-13	DAT08668	3	13,92
YFM 660 Raptor	01-05	DAT08668	3	13,92
YFM 660 Grizzly	02-08	DAT08668	3	13,92
YFM 700 Raptor	06-13	DAT08668	3	13,92
YFM 700 Grizzly	07-14	DAT08668	3	13,92

BRONCO Kit Reparación basculante

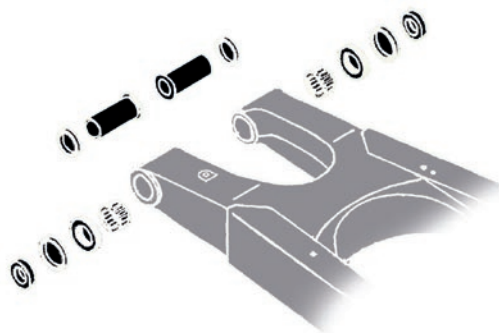

ARCTIC CAT	Año	Referencia	Nº Piezas	€
400 DVX	03-08	DAT04303		53,42

HONDA	Año	Referencia	Nº Piezas	€
TRX 250 EX Sportrax	01-11	DAT04338		29,44
TRX 250 Recon	97-12	DAT04338		29,44
TRX 400 EX Sportrax	99-09	DAT04116	10	40,08
TRX 420 Rancher	07-12	DAT04318		40,80
TRX 450 R	04-12	DAT04305	12	37,28

KAWASAKI	Año	Referencia	Nº Piezas	€
KVF 300 Prairie	99-02	DAT04307	12	38,68
KVF 360 Prairie	03-12	DAT04307	12	38,68
KFX 400	03-06	DAT04303		53,42
KVF 400 Prairie	98-02	DAT04307	12	38,68
KFX 450 R	08-11	DAT04306		56,30
KVF 650 Prairie	02-03	DAT04307	12	38,68
KVF 650 Brute Force	05-11	DAT04307	12	38,68
KVF 650i Brute Force	06-12	DAT04307	12	38,68
KVF 700 Prairie	04-06	DAT04307	12	38,68
KFX 700 V-Force	04-09	DAT04307	12	38,68

SUZUKI	Año	Referencia	Nº Piezas	€
LT-R 250 Quadraacer	87-92	DAT04308	14	47,92
LT-Z 400 QuadSport	03-12	DAT04303	14	57,65
LT-R 450	06-09	DAT04309	18	69,55
LT-R 500 Quadraacer	87-90	DAT04308	14	47,92
LT-V 700 Twin Peaks	04-05	DAT04307	12	38,68

YAMAHA	Año	Referencia	Nº Piezas	€
YFS 200 Blaster	88-06	DAT04300		45,14
YFM 350 Warrior	87-04	DAT04312	7	42,43
YFM 350 Raptor	04-13	DAT04312	7	42,43
YFZ 350 Banshee	91-06	DAT04301		42,06
YFZ 450	04-13	DAT04314	14	49,76
YFZ 450 R	09-17	DAT04328		38,95
YFM 660 Raptor	01-05	DAT04315	18	45,79
YFM 700 Raptor	06-17	DAT04316	14	47,26

BRONCO

Kit soporte columna dirección

No dejes que tu Yamaha tenga holgura en la dirección, aquí tienes este kit, a un mínimo coste.

Referencia	€
DAT08655	10,50

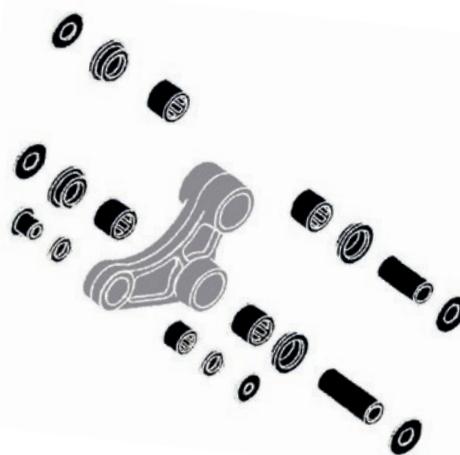

BRONCO Kit Reparación bieleta

ARCTIC CAT	Año	Referencia	Nº Piezas	€
400 DVX	03-08	DAT04118	25	78,88

KAWASAKI	Año	Referencia	Nº Piezas	€
KFX 400	03-06	DAT04118	25	78,88

SUZUKI	Año	Referencia	Nº Piezas	€
LT-Z 400 QuadSport	03-12	DAT04118	25	78,88
LT-R 450	06-09	DAT04119	25	71,60

YAMAHA	Año	Referencia	Nº Piezas	€
YFM 350 Raptor	04-13	DAT04341	20	30,12
YFM 350 Warrior	87-04	DAT04342	22	47,21
YFZ 350 Banshee	87-06	DAT04342	22	47,21
YFZ 450	04-13	DAT04343	18	51,12
YFZ 450 R	09-17	DAT04345	17	52,20
YFM 660 Raptor	01-05	DAT04346	22	45,36
YFM 700 Raptor	06-17	DAT04347	16	39,46



4PLAY Rotulas dirección

ARCTIC CAT	Año	Interior	Exterior
250 DVX	06-08	DAT08125	DAT081251
300 DVX	09-12	DAT08125	DAT081251
400 DVX	04-08	DAT08125	DAT081251
Resto ATV	00-11	DAT08564	DAT08770
1000 Wildcat	13-14	DAT08751	DAT08750

CAN AM	Año	Interior	Exterior
330 Outlander	04-05	DAT08568L	DAT08122
400 Outlander	03-16	DAT08568L	DAT08122
500 Renegade	08-12	DAT08568L	DAT08122
500 Renegade	13-16	DAT08761	DAT08760
500 Outlander	07-12	DAT08568L	DAT08122
500 Outlander	13-14	DAT08761	DAT08760
500 Traxter	99-05	DAT08760	DAT08761
650 DS	00-07	DAT08760	DAT08761
650 Outlander	06-12	DAT08568L	DAT08122
650 Outlander	13-17	DAT08760	DAT08761
650 Quest	02-04	DAT08760	DAT08761
650 Traxter	04-05	DAT08760	DAT08761
800 Commander	11-12	DAT08568L	DAT08122
800 Commander	13-15		DAT08775
800 Renegade	07-11	DAT08568L	DAT08122
800 Renegade	12-16	DAT08760	DAT08761
800 Outlander	06-11	DAT08568L	DAT08122
800 Outlander	13-16	DAT08760	DAT08761
1000 Commander	11-12	DAT08568L	DAT08122
1000 Commander	13-16		DAT08775
1000 Maverick	13-17		DAT08776
1000 Renegade	2012	DAT08568L	DAT08122
1000 Renegade	12-14	DAT08760	DAT08761
1000 Outlander	2012	DAT08568L	DAT08122
1000 Outlander	12-17	DAT08760	DAT08761

HONDA	Año	Interior	Exterior
TRX 90	93-14	DAT08562	DAT08121
TRX 250 EX Sportrax	01-14	DAT08123	DAT08122
TRX 250 Recon	97-14	DAT08123	DAT08122
TRX 300 Sportrax	93-08	DAT08567	DAT08124
TRX 300 Fourtrax	88-00	DAT08123	DAT08122
TRX 350 Rancher	00-06	DAT08123	DAT08122
TRX 400 Sportrax	99-14	DAT08567	DAT08124
TRX 400 Foreman	95-03	DAT08123	DAT08122
TRX 400 Rancher	04-06	DAT08123	DAT08122
TRX 420 Rancher	07-14	DAT08123	DAT08122
TRX 450 R Sportrax	04-14	DAT08567	DAT08124
TRX 450 Foreman	98-04	DAT08123	DAT08122
TRX 500 Rubicon	01-12	DAT08123	DAT08122
TRX 500 Foreman	05-13	DAT08123	DAT08122
TRX 650 Rincon	03-05	DAT08123	DAT08122
TRX 680 Rincon	06-13	DAT08123	DAT08122

KAWASAKI	Año	Interior	Exterior
KSF 80 KFX	03-06	DAT08126	DAT08136
KLF 220 Bayou	88-02	DAT08126	DAT08136
KLF 250 Bayou	03-11	DAT08126	DAT08136
KSF 250 Mojave	87-04	DAT08126	DAT08136
KEF 300 Lakota	95-03	DAT08126	DAT08136
KLF 300 Bayou	86-04	DAT08126	DAT08136
KVF 300 Brute Force	12-14	DAT08125	DAT081251
KVF 300 Prairie	99-02	DAT08126	DAT08136

KVF 360 Prairie	03-10	DAT08568L	DAT08122
KFX 400	2003	DAT08126	DAT08136
KFX 400	04-06	DAT081251	DAT08125
KLF 400 Bayou	93-02	DAT08126	DAT08136
KVF 400 Prairie	98-02	DAT08126	DAT08563
KFX 450 R	08-14	DAT08566	DAT08565
KVF 650 Prairie	02-03	DAT08124	DAT08563
KVF 650 Brute Force	05-12	DAT08564	DAT08563
KVF 650 i Brute Force	06-13	DAT08124	DAT08567
KVF 700 Prairie	04-06	DAT08564	DAT08563
KVF 750 i Brute Force	05-17	DAT08567	DAT08124

KYMCO	Año	Interior	Exterior
Mxer 150	05-07	DAT081251	DAT08125
Mxu 150	05-08	DAT081251	DAT08125
Mxu 250	04-05	DAT081251	DAT08125
Mxu 300	05-10	DAT081251	DAT08125

POLARIS	Año	Interior	Exterior
200 Phoenix	06-09	DAT08126	
250 Trail Blazer	90-94		DAT08129
250 Trail Blazer	1996	DAT08128	DAT08129
250 Trail Blazer	97-06	DAT08131	DAT08129A
250 Trail Boss	88-99	DAT08128	DAT08127
250 Xplorer	00-02	DAT08131	DAT08129A
300 Hawkeye	06-11	DAT08758	DAT08759
300 Sportsman	08-10	DAT08758	DAT08759
300 Xplorer	96-97	DAT08128	DAT08129
300 Xplorer	98-99	DAT08131	DAT08129A
300 Xpress	96-97	DAT08128	DAT08127
300 Xpress	98-99	DAT08131	DAT08129A
325 Magnum	00-02	DAT08131	DAT08129A
325 Xpedition	00-02	DAT08131	DAT08129A
325 Trail Boss	00-02	DAT08131	DAT08129A
330 Trail Boss	03-13	DAT08131	DAT08129A
330 Magnum	03-06	DAT08131	DAT08129A
330 Trail Blazer	08-13	DAT08131	DAT08129A
335 Sportsman	99-00	DAT08131	DAT08129A
350 Trail Boss	90-93	DAT08128	DAT08127
400 Hawkeye	12-14	DAT08131	DAT08129A
400 Scrambler	95-96	DAT08128	DAT08129
400 Scrambler	97-02	DAT08131	DAT08129A
400 Sportsman	93-94	DAT08128	DAT08127
400 Sportsman	95-97	DAT08128	DAT08129
400 Sportsman	01-05	DAT08131	DAT08129A
400 Sportsman	08-10	DAT08758	DAT08759
400 Sportsman	11-14	DAT08131	DAT08129A
400 Sport	95-96	DAT08128	DAT08129
400 Sport	97-99	DAT08131	DAT08129A
400 Trail Boss	1994	DAT08128	DAT08127
400 Trail Blazer	2003	DAT08131	DAT08129A
400 Xplorer	95-97	DAT08128	DAT08129
400 Xplorer	98-02	DAT08131	DAT08129A
425 Magnum	95-97	DAT08128	DAT08129
425 Magnum	1998	DAT08131	DAT08129A
425 Xpedition	00-02	DAT08131	DAT08129
450 Outlaw	2008	DAT08574L	DAT08574R
450 Outlaw	09-10	DAT08569L	DAT08569R
450 Sportman	06-07	DAT08131	DAT08129A
500 ATP	04-05	DAT08131	DAT08129A
500 Big Boss 6x6	98-03	DAT08131	DAT08129A
500 Magnum	99-03	DAT08131	DAT08129A



Especificaciones:

R: Rosca derecha
L: Rosca izquierda

Referencia	€
DAT08121	R
DAT08122	R
DAT08123	L
DAT08124	R
DAT08125	R
DAT081251	L
DAT08126	R
DAT08127	L
DAT08128	R
DAT08129	L
DAT08129A	L
DAT08130	L
DAT08131	R
DAT08136	L
DAT08557	R
DAT08558	R
DAT08559	L
DAT08560	L
DAT08561	R
DAT08562	L
DAT08563	L
DAT08564	R
DAT08565	R
DAT08566	L
DAT08567	L
DAT08568L	L
DAT08569L	L
DAT08569R	R
DAT08574L	L
DAT08574R	R
DAT08575L	L
DAT08575R	R
DAT08750	L
DAT08751	R
DAT08752	L
DAT08758	R
DAT08759	L
DAT08760	L
DAT08761	R
DAT08762	R
DAT08765	L
DAT08766	L
DAT08771	L
DAT08772	R
DAT08773	L
DAT08774	R
DAT08775	R
DAT08776	R



4PLAY Rotulas dirección



500 Predator	03-06	DAT08574R	DAT08574L
500 Scrambler	97-12	DAT08131	DAT08129A
500 Sportsman	1996	DAT08128	DAT08129
500 Sportsman	1997	DAT08128	
500 Sportsman	98-00	DAT08131	DAT08129A
500 Xplorer	1997	DAT08128	DAT08129
525 Outlaw	09-10	DAT08569L	DAT08569R
550 Sportsman	09-13	DAT08772	DAT08771
550 Sportsman X2	10-14	DAT08772	DAT08771
570 Sportsman	2014	DAT08131	DAT08129A
570 Sportsman ACE	15-16		DAT08129A
570 Sportsman ACE	2017		DAT08752
600 Sportsman	03-05	DAT08131	DAT08129A
700 Sportsman	02-08	DAT08131	DAT08129A
800 Sportsman	05-13	DAT08131	DAT08129A
800 RZR	08-14		DAT08129A
800 RZR "S"	09-14		DAT08129A
800 RZR "4"	10-14		DAT08129A
850 Scrambler	2013	DAT08772	DAT08771
850 Sportsman	2009	DAT08569R	DAT08569L
850 Sportsman	10-13	DAT08772	DAT08771
900 Sportsman ACE	2016		DAT08129A
900 Sportsman ACE	2017		DAT08752
900 RZR XP	11-14		DAT08129A
900 RZR XP "4"	12-14		DAT08129A
900 RZR XP "izq." "der."	15-17		DAT08773 DAT08774
900 RZR XP "4" "izq." "der."	15-17		DAT08773 DAT08774
1000 RZR XP	14-15		DAT08752
1000 RZR XP	15-17		DAT08765
1000 RZR XP "4"	14,16		DAT08752
1000 RZR XP "4"	15,17		DAT08765
1000 RZR XP "izq." "der."	2016		DAT08773 DAT08774
1000 RZR XP Turbo	2017		DAT08765
1000 RZR XP Turbo "4"	2017		DAT08765
1000 General "izq." "der."	16-17		DAT08773 DAT08774
425/500/550/700 Ranger	todos		DAT08129A
SUZUKI			
LT 80	87-06	DAT08126	DAT08136
LT-F 160	89-04	DAT08562	DAT08121
LT 250 R	90-92	DAT08136	DAT08126
LT-Z 250	04-08	DAT08125	DAT081251
LT-F 250 Quadrunner	88-02	DAT08136	DAT08126
LT-F 250 Ozark	02-03	DAT08136	DAT08126
LT-F 250 Ozark	04-12	DAT081251	DAT08125
LT-Z 400	2003	DAT08136	DAT08126
LT-Z 400	04-08	DAT08125	DAT081251
LT-Z 400	09-13	DAT08566	DAT08565
LT-A 400 Eiger	02-04	DAT08136	DAT08126
LT-A 400 Eiger	05-07	DAT081251	DAT08125
LT-F 400 Eiger	02-04	DAT08136	DAT08126
LT-F 400 Eiger	05-07	DAT081251	DAT08125
LT-A 400 King Quad	08-11	DAT081251	DAT08125

LT-F 400 King Quad	08-11	DAT081251	DAT08125
LT-R 450	06-11	DAT08566	DAT08565
LT-A 450 King Quad	07-10	DAT08575L	DAT08575R
LT-A 500 Vinson	02-03	DAT08136	DAT08126
LT-A 500 Vinson	04-07	DAT081251	DAT08125
LT-F 500 Vinson	2003	DAT08136	DAT08126
LT-F 500 Vinson	04-07	DAT081251	DAT08125
LT-A 500 King Quad	09-10	DAT08566	DAT08565
LT-A 500 King Quad	11-13	DAT08575L	DAT08575R
LT-V 700 Twin Peaks	04-06	DAT08563	
LT-A 700 King Quad	05-07	DAT08575L	DAT08575R
LT-A 750 King Quad	08-13	DAT08575L	DAT08575R

YAMAHA

	Año	Interior	Exterior
YFA 125 Brezee	89-04	DAT08125	DAT081251
YFM 125 Grizzly	04-13	DAT08125	DAT081251
YFM 125 Raptor	11-13	DAT08125	DAT081251
YFS 200 Blaster	88-06	DAT08125	DAT081251
YFM 250 Raptor	08-13	DAT08125	DAT081251
YFB 250 Timberwolf	92-98	DAT08125	DAT081251
YFM 250 Bear Tracker	99-04	DAT08558	DAT08559
YFM 250 Big Bear	07-09	DAT08558	DAT08559
YFM 250 Bruin	05-06	DAT08558	DAT08559
YFM 350 Warrior	88-04	DAT08125	DAT081251
YFM 350 Raptor	04-12	DAT08125	DAT081251
YFZ 350 Banshee	87-06	DAT08125	DAT081251
YFM 350 Wolverine semi.	95-05	DAT08125	DAT081251
YFM 350 Wolverine auto.	06-09	DAT08558	DAT08559
YFM 350 Big Bear	87-99		DAT08130
YFM 350 Bruin	04-06	DAT08558	DAT08560
YFM 350 Grizzly	07-12	DAT08558	DAT08559
YFM 350 Grizzly	13-15	DAT08125	DAT081251
YFM 400 Big Bear semi.	00-06	DAT08558	DAT08559
YFM 400 Big Bear auto.	07-13	DAT08558	DAT08559
YFM 400 Kodiak Semi.	93-02	DAT08125	DAT081251
YFM 400 Kodiak auto.	00-01	DAT08125	DAT081251
YFM 400 Kodiak auto.	02-04		DAT08130
YFM 400 Kodiak auto.	05-06	DAT08558	DAT08560
YFM 400 Grizzly	07-10	DAT08558	DAT08560
YFM 450 Grizzly	07-12	DAT08558	DAT08560
YFM 450 Grizzly	13-15	DAT08125	DAT081251
YFM 450 Kodiak	04-06	DAT08558	DAT08560
YFM 450 Wolverine	2006	DAT08558	DAT08560
YFM 450 Wolverine	07-11	DAT08558	DAT08560
YFZ 450	04-05	DAT08125	DAT081251
YFZ 450	06-13	DAT08565	DAT08566
YFZ 450 R	09-17	DAT08565	DAT08566
YFM 550 Grizzly	09-15	DAT08125	DAT081251
YFM 600 Grizzly	98-01	DAT08125	DAT081251
YFM 660 Raptor	01-05	DAT08125	DAT081251
YFM 660 Grizzly	02-08	DAT08125	DAT081251
YFM 700 Grizzly	07-17	DAT08125	DAT081251
YFM 700 Kodiak	16-17	DAT08125	DAT081251
YFM 700 Raptor	06-17	DAT08565	DAT08566

RUEDAS Y NEUMÁTICOS

MOTOR

ADMISIÓN / ESCAPE
REFRIGERACIÓN

ELECTRICO

SUSPENSIÓN / DIRECCIÓN

FRENOS

TRANSMISIÓN

CONTROLES Y MANDOS

CHASIS

ACCESORIOS

€
19

€
23

€
28

4PLAY Rotulas trapecios

ARCTIC CAT	Año	Inferior	Superior
400 DVX	04-08		DAT08581
1000 XT	13-14	DAT08581	DAT08581
1000 Wildcat "4"	13-14	DAT08816	DAT08816
1000 Wildcat "X"	13-14	DAT08816	DAT08816
Resto de modelos	02-14	DAT08580	DAT08580

CAN AM	Año	Inferior	Superior
330 Outlander	04-05		DAT08806
400 Outlander	03-05		DAT08806
400 Outlander	06-14	DAT08812	DAT08806
500 Outlander	07-12	DAT08812	DAT08806
500 Outlander	13-14	DAT08818	DAT08819
500 Renegade	08-12	DAT08810	DAT08810
500 Renegade	13-14	DAT08818	DAT08819
500 Traxter	00-05	DAT08810	DAT08810
650 Outlander	06-12	DAT08812	DAT08810
650 Outlander	13-14	DAT08818	DAT08819
650 Traxter	04-05	DAT08810	DAT08810
650 Quest	02-04	DAT08810	DAT08810
800 Comander	11-13	DAT08818	DAT08819
Renegade 800	07-11	DAT08810	DAT08810
Renegade 800	12-14	DAT08818	DAT08819
Outlander 800	06-12	DAT08812	DAT08810
Outlander XT 800 R	2012	DAT08818	DAT08819
Outlander 800	13-14	DAT08818	DAT08819
Comander 1000	12-13	DAT08818	DAT08819
Renegade 1000	12-14	DAT08818	DAT08819
Outlander 1000	12-14	DAT08818	DAT08819
Maverick 1000	2013	DAT08815	DAT08814
Maverick 1000	13-15	DAT08818	DAT08819

HONDA	Año	Inferior	Superior
TRX 250 Recon	97-14	DAT08553	DAT04023
TRX 250 Sportrax	01-14		DAT04023
TRX 300 Fourtrax	88-00	DAT04023	DAT04023
TRX 350 Rancher	00-06	DAT04023	DAT04024
TRX 400 Fourtrax	95-03	DAT04023	DAT04023
TRX 400 Fourtrax	04-07	DAT04023	DAT04024
TRX 420 Rancher	07-14	DAT04023	DAT04024
TRX 450 Fourtrax	98-04	DAT04024	DAT04024
TRX 500 Rubicon	01-10	DAT04024	DAT04024
TRX 500 Foreman	05-14	DAT04024	DAT04024
TRX 650 Rincon	03-05	DAT04024	DAT04024
TRX 680 Rincon	06-14	DAT04024	DAT04024

KAWASAKI	Año	Inferior	Superior
KFX 250 Tecate	87-88	DAT08599	DAT08576
KSF 250 Mojave	87-04	DAT08599	DAT08576
KEF 300 Lakota	95-03		DAT08576
KLF 300 C Bayou	89-04	DAT08599	DAT08576
KVF 300 Prairie	99-00		DAT08806
KVF 300 Prairie	01-02	DAT08805	DAT08806
KVF 360 Prairie	03-13	DAT08582	DAT08806
KFX 400	2003		DAT08582
KFX 400	04-06		DAT08581
KLF 400 Bayou	93-99	DAT08599	DAT08576
KVF 400 Prairie	98-00	DAT08599	DAT08806

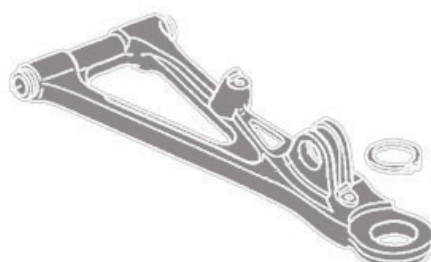

KVF 400 Prairie	01-02	DAT08805	DAT08806
KFX 450 R	08-14	DAT08582	DAT08582
KVF 650 Pairie	02-03	DAT08582	DAT08806
KVF 650 Brute Force	05-12	DAT08582	DAT08806
KVF 650 i Brute Force	06-13	DAT08582	DAT08582
KFX 700 V-Force	04-09	DAT08582	DAT08582
KVF 700 Prairie	04-06	DAT08582	DAT08806
KVF 750i Brute Force	05-14	DAT08582	DAT08582
750 Teryx	08-13	DAT08582	DAT08582

POLARIS	Año	Inferior	Superior
200 Phoenix	05-13	DAT08802	DAT08802
200 Sawtooth	2007	DAT08802	DAT08802
250 Trail Blazer	90-06	DAT08554	
250 Trail Boss	88-99	DAT08554	
250 Xplorer	00-02	DAT08554	
300 Hawkeye	06-11	DAT08807	
300 Trail Boss	1995	DAT08554	
300 Sportsman	08-10	DAT08807	
325 Magnum	01-02	DAT08554	
325 Xpedition	00-02	DAT08554	
325 Trail Boss	00-02	DAT08554	
330 Magnum	03-05	DAT08554	
330 Trail Blazer	08-13	DAT08554	
330 Trail Boss	03-13	DAT08554	
400 Trail Blazer	2003	DAT08554	
400 Scrambler	95-02	DAT08554	
400 Sport	94-99	DAT08554	
400 Sportsman	94-14	DAT08554	
450 Outlaw	08-10	DAT08803	DAT08803
450 Sportsman	06-07	DAT08554	
500 Outlaw	06-07	DAT08803	DAT08803
500 Predator	03-06	DAT08802	DAT08802
500 Predator	2007	DAT08803	DAT08803
500 Magnum	99-03	DAT08554	
500 Ranger	99-14	DAT08554	
500 Scrambler	97-12	DAT08554	
500 ATP	04-05	DAT08554	
500 Sportsman	96-13	DAT08554	
525 Outlaw	07-11	DAT08803	DAT08803
550 Sportsman	09-14	DAT08807	DAT08807
550 Sportsman	15-17	DAT08826	
570 Sportsman	15-17	DAT08826	DAT08826
570 RZR	12-15	DAT08807	DAT08807
600 Sportsman	03-05	DAT08554	
700 Sportsman	02-08	DAT08554	
700 Ranger	05-09	DAT08554	
700 Ranger	2009	DAT08807	DAT08807
800 Sportsman	05-13	DAT08554	
800 Ranger	10-14	DAT08807	DAT08807
800 RZR	08-14	DAT08807	DAT08807
800 RZR "S"	09-14	DAT08807	DAT08807
800 RZR "4"	10-14	DAT08807	DAT08807
850 Sportsman	09-14	DAT08807	DAT08807
900 ACE	2017	DAT08826	DAT08826
900 RZR XP	2011	DAT08807	DAT08807
900 RZR XP	12-14	DAT08813	DAT08813
1000 RZR XP	14-15	DAT08577	DAT08577
1000 RZR XP "4"	14-15	DAT08577	DAT08577

€
19

€
23

€
28

4PLAY Rotulas trapecios

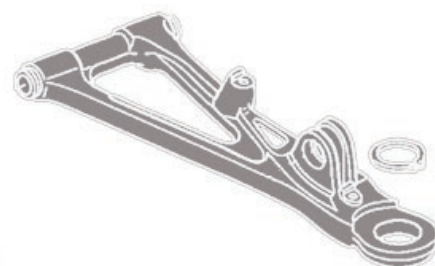

SUZUKI	Año	Inferior	Superior
LT-Z 250 Quad Sport	04-09	DAT08801	DAT08801
LT-F 250 (Excluido Ozark)	89-02	DAT08556	DAT08556
LT-F 250 Ozark	05-12		DAT08581
LT-F 300 King Quad	99-02	DAT08556	DAT08556
LT-Z 400	03-04		DAT08582
LT-Z 400	05-12		DAT08581
LT-A 400 Eiger	02-07	DAT08350	DAT08350
LT-F 400 Eiger	02-08	DAT08350	DAT08350
LT-A 450 King Quad	07-10	DAT08581	DAT08581
LT-A 500 Quad Master	00-01	DAT08556	
LT-F 500 Quad Runner	98-99	DAT08556	
LT-A 500 Vinson	02-07	DAT08350	DAT08350
LT-F 500 Vinson	02-07	DAT08350	DAT08350
LT-A 500 King Quad	09-11	DAT08581	DAT08581
LT-V 700 Twin Peaks	04-06		DAT08806
LT-A 700 King Quad	05-07	DAT08581	DAT08581
LT-A 750 King Quad	08-13	DAT08581	DAT08581

YAMAHA	Año	Inferior	Superior
YFB 250 Timberwolf	92-98		DAT08806
YFM 250 Bear Tracker	99-04	DAT08823	DAT08806
YFM 250 Big Bear	07-09	DAT08823	DAT08806
YFM 250 Bruin	05-06	DAT08823	DAT08806
YFM 350 Bruin	04-06	DAT04023	DAT04023
YFM 350 Grizzly	07-16	DAT04023	DAT04023
YFM 350 Grizzly IRS	07-11	DAT04023	DAT04023
YFM 350 Wolverine auto.	06-09	DAT04023	DAT04023
YFM 400 Big Bear	00-06	DAT04023	DAT04023
YFM 400 Big Bear IRS	07-12	DAT04023	DAT04023
YFM 400 Grizzly IRS	07-09	DAT04023	DAT04023
YFM 400 Kodiak	03-06	DAT04023	DAT04023
YFM 450 Grizzly	07-16	DAT04023	DAT04023
YFM 450 Kodiak	03-06	DAT04023	DAT04023
YFM 450 Wolverine	06-10	DAT04023	DAT04023
YFZ 450	04-13	DAT08801	
YFZ 450 R	09-16	DAT08801	
YXR 450 Rhino	06-09	DAT04023	DAT04023
YFM 550 Grizzly	09-15	DAT08800	DAT08801
YFM 600 Grizzly	98-01		DAT08806
YFM 660 Raptor	01-05	DAT08801	
YFM 660 Grizzly	02-08	DAT08809	
YXR 660 Rhino	04-07	DAT04023	DAT04023
YFM 700 Raptor	06-16	DAT08801	
YFM 700 Grizzly	07-15	DAT08800	DAT08801
YXE 700 Wolverine	16-17	DAT08821	DAT08821
YXM 700 Viking	14-17	DAT08821	DAT08821
YXR 700 Rhino	08-13	DAT04023	DAT04023

4PLAY Rotulas barra estabilizadora

€
29

YAMAHA	Año	Izquierda	Derecha
YFM 350 Grizzly IRS	10-11	DAT08766	DAT08762
YFM 400 Big Bear	10-11	DAT08766	DAT08762
YFM 450 Grizzly	10-14	DAT08766	DAT08762
YFM 550 Grizzly	10-14	DAT08766	DAT08762
YFM 700 Grizzly	10-14	DAT08766	DAT08762
YXR 700 Viking	14-15	DAT08766	DAT08762



RUEDAS Y NEUMÁTICOS

MOTOR

ADMISIÓN / ESCAPE
REFRIGERACIÓN

ELECTRICO

SUSPENSIÓN / DIRECCIÓN

FRENOS

TRANSMISIÓN

CONTROLES Y MANDOS

CHASIS

ACCESORIOS

SUSPENSIÓN / DIRECCIÓN

4PLAY Kit casquillos trapecios delanteros

Consta de todo el material necesario para la reconstrucción completa de un trapecio.

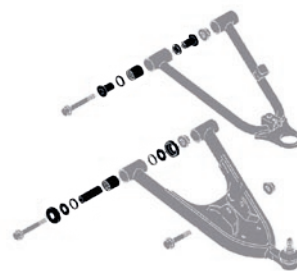

		TRAPECIO SUPERIOR		TRAPECIO INFERIOR	
ARCTIC CAT	Año	Referencia	€	Referencia	€
400 DVX	04-07	DAT04120	39,92	DAT041201	38,96
400 a 1000 todos atv	10-14	DAT045031	5,25	DAT045021	6,30

		TRAPECIO SUPERIOR		TRAPECIO INFERIOR	
CAN AM	Año	Referencia	€	Referencia	€
330 Outlander	04-05			DAT04348	14,47
400 Outlander	03-15			DAT04348	14,47
450 DS	08-12	DAT04348	14,47	DAT04348	14,47
450 Outlander	2015	DAT04348	14,47	DAT04348	14,47
500 Outlander	07-15			DAT04348	14,47
500 Quest	02-03			DAT04348	14,47
500 Renegade	08-12	DAT04348	14,47	DAT04348	14,47
500 Traxter	01-05	DAT04348	14,47	DAT04348	14,47
650 Outlander	07-15	DAT04348	14,47	DAT04348	14,47
650 Quest	02-04	DAT04348	14,47	DAT04348	14,47
650 Traxter	04-05	DAT04348	14,47	DAT04348	14,47
800 Commander	11-15	DAT04164	23,73	DAT04348	14,47
800 Commander	16-17	DAT04164	23,73		
800 Outlander	06-12	DAT04348	14,47	DAT04348	14,47
800 Renegade	07-12	DAT04348	14,47	DAT04348	14,47
1000 Commander	11-15	DAT04164	23,73	DAT04348	14,47
1000 Commander	16-17	DAT04164	23,73		
1000 Outlander	2012	DAT04348	14,47	DAT04348	14,47
1000 Renegade	2012	DAT04348	14,47	DAT04348	14,47

		TRAPECIO SUPERIOR		TRAPECIO INFERIOR	
HONDA	Año	Referencia	€	Referencia	€
TRX 90	93-13			DAT04134	33,10
TRX 200	90-97	DAT04134	33,10	DAT04134	33,10
TRX 250 Recon	97-13	DAT04134	33,10	DAT04134	33,10
TRX 250R	87-92	DAT04122	37,36	DAT04122	37,36
TRX 250 Sportrax	01-11	DAT04134	33,10	DAT04134	33,10
TRX 300 Sportrax	93-08	DAT04122	37,36	DAT04122	37,36
TRX 300 Fourtrax 4x4	88-00	DAT04134	33,10	DAT04134	33,10
TRX 350 Rancher	00-06	DAT04134	33,10	DAT04134	33,10
TRX 400 Sportrax	99-07	DAT04122	37,36	DAT04122	37,36
TRX 400 Rancher	95-06	DAT04134	33,10	DAT04134	33,10
TRX 420 Rancher	07-14	DAT04134	33,10	DAT04134	33,10
TRX 450R Sportrax	04-08	DAT04122	37,36	DAT04122	37,36
TRX 450 Foreman	98-04	DAT04134	33,10	DAT04134	33,10
TRX 500 Fourtrax 4x4	01-08	DAT04123	21,37	DAT04134	33,10
TRX 500 Rancher 4x4	09-14	DAT04123	21,37	DAT04134	33,10
TRX 650 Rincon 4x4	03-05	DAT04124	21,48	DAT04134	33,10
TRX 680 Rincon 4x4	06-14	DAT04124	21,48	DAT04134	33,10
TRX 700 XX	08-09	DAT04122	37,36	DAT04122	37,36

		TRAPECIO SUPERIOR		TRAPECIO INFERIOR	
KAWASAKI	Año	Referencia	€	Referencia	€
KSF 250 Mojave	87-04	DAT04125	40,43	DAT04125	40,43
KXF 250 Tecate	1987	DAT04125	40,43	DAT04125	40,43
KEF 300 Lakota	95-03	DAT04125	40,43	DAT04125	40,43
KLF 300 Bayou	88-04	DAT04121	31,30	DAT04121	31,30
KLF 300 Prairie	99-02			DAT04121	31,30
KLF 360 Prairie	03-12			DAT04121	31,30
KLF 400 Bayou	89-04	DAT04121	31,30	DAT04121	31,30
KLF 400 Prairie	98-02			DAT04121	31,30
KFX 400	03-06	DAT04120	39,92	DAT041201	38,96
KFX 450R	08-14	DAT04127	39,97		
KVF 650 Prairie	02-03			DAT04126	49,78
KVF 650 Brute Force	05-09			DAT04126	49,78
KVF 650 i Brute Force	06-13	DAT04135	40,51	DAT04127	39,97
KVF 700 Prairie	04-06			DAT04126	49,78
KFX 700 V-Force	04-09	DAT04127	39,97	DAT04127	39,97
KVF 750 Brute Force	05-12	DAT04135	40,51	DAT04127	39,97
KRF 750 Tryx	08-13	DAT04500	49,67	DAT04500	49,67

		TRAPECIO SUPERIOR		TRAPECIO INFERIOR	
POLARIS	Año	Referencia	€	Referencia	€

POLARIS: MÁS INFORMACIÓN SIGUIENTE PÁGINA

SUZUKI	Año	Referencia	€	Referencia	€
LT-Z 250	04-08	DAT04128	33,90	DAT04128	33,90
LT-F 250 Quad Runner	89-02	DAT04128	33,90	DAT04128	33,90
LT-F 250 Ozark	02-12	DAT04128	33,90	DAT04128	33,90
LT-F 300 King Quad	97-02	DAT04128	33,90	DAT04128	33,90
LT-Z 400	03-12	DAT04120	39,92	DAT041201	38,96
LT-A 400 Eiger	02-07	DAT04128	33,90	DAT04128	33,90
LT-F 400 Eiger	02-07	DAT04128	33,90	DAT04128	33,90
LT-A 400 King Quad	08-11	DAT04128	33,90	DAT04128	33,90
LT-A 450 King Quad	07-10	DAT04329	27,84	DAT04128	33,90
LT-A 500 King Quad	09-11	DAT04332		DAT04334	
LT-F 500 Quad Runner	98-02	DAT04128	33,90	DAT04128	33,90
LT-A 500 Vinson	02-07	DAT04128	33,90	DAT04128	33,90
LT-A 500 King Quad	09-15	DAT04329	27,84		
LT-A 700 King Quad	05-07	DAT04136	31,39	DAT04128	33,90
LT-V 700 Twin Peaks	04-06			DAT04126	49,78
LT-A 750 King Quad	08-15	DAT04329	27,84		

		TRAPECIO SUPERIOR		TRAPECIO INFERIOR	
YAMAHA	Año	Referencia	€	Referencia	€

YFA1 125 Breeze	91-04			DAT04131	26,14
YFM 125 Grizzly	04-13			DAT04131	26,14
YFM 125 Raptor	11-13	DAT04132	23,83	DAT04131	26,14
YFS 200 Blaster	88-06	DAT04130	22,41	DAT04131	26,14
YFM 250 Raptor	08-13	DAT04132	23,83	DAT04131	26,14
YFM 350 Warrior	87-04	DAT04131	26,14	DAT04131	26,14
YFM 350 Raptor	04-13	DAT04131	26,14	DAT04131	26,14
YFZ 350 Banshee	91-06	DAT04132	23,83	DAT04131	26,14
YFZ 450	04-13	DAT04132	23,83	DAT04131	26,14
YFZ 450 R	09-16	DAT04132	23,83	DAT04131	26,14
YFM 660R Raptor	01-05	DAT04133	25,31	DAT04131	26,14
YFM 700R Raptor	06-16	DAT04132	23,83	DAT04131	26,14

4PLAY Casquillos trapecios Yamaha

Referencia	Descripción	€
DAT041321	Kit 4 casquillos	7,30
DAT041322	Kit 12 casquillos	17,28



BRONCO Kits de casquillos para todo el vehículo

POLARIS 2009	Unidades	Ref.Origen	Ref.Utilizadas	Referencia	€
Trapezios delanteros superior + inferior	16	5436798	DAT04582		
Trapezios traseros superior + inferior	20	5436798	DAT04582		
Casquillos superiores buje trasero	2	5436798	DAT04582	DAT04156	52,60
Casquillos inferiores buje trasero	2	5437651	DAT04580		

POLARIS 2010	Unidades	Ref.Origen	Ref.Utilizadas	Referencia	€
Trapezios delanteros superior + inferior	16	5436832	DAT041441		
Trapezio trasero inferior	8	5436832	DAT041441		
Trapezio trasero superior	4	5436973	DAT04145A1	DAT04157	52,60
Casquillos superiores buje trasero	4	5436832	DAT041441		
Casquillos inferiores buje trasero	4	5437651	DAT04580		

POLARIS 2011-13	Unidades	Ref.Origen	Ref.Utilizadas	Referencia	€
Trapezios delanteros superior + inferior	16	5436798	DAT04582		
Trapezio trasero inferior	8	5436798	DAT04582		
Trapezio trasero superior	4	5436973	DAT04145A1	DAT04158	52,60
Casquillos superiores buje trasero	4	5436832	DAT041441		
Casquillos inferiores buje trasero	4	5437651	DAT04580		

POLARIS 2014	Unidades	Ref.Origen	Ref.Utilizadas	Referencia	€
Trapezios delanteros superior + inferior	16	5439874	DAT04583		
Trapezio trasero inferior	8	5439874	DAT04583		
Trapezio trasero superior	4	5436973	DAT04145A1	DAT04159	52,60
Casquillos superiores buje trasero	4	5439874	DAT041441		
Casquillos inferiores buje trasero	4	5437651	DAT04580		

POLARIS 2015	Unidades	Ref.Origen	Ref.Utilizadas	Referencia	€
Trapezios delanteros superior + inferior	16	1543367	DAT04581		
Trapezio trasero inferior	8	1543367	DAT04581		
Trapezio trasero superior	4	1543326	DAT04150	DAT04160	152,44
Casquillos superiores buje trasero	4	5439874	DAT041441		
Casquillos inferiores buje trasero	4	5437651	DAT04580		

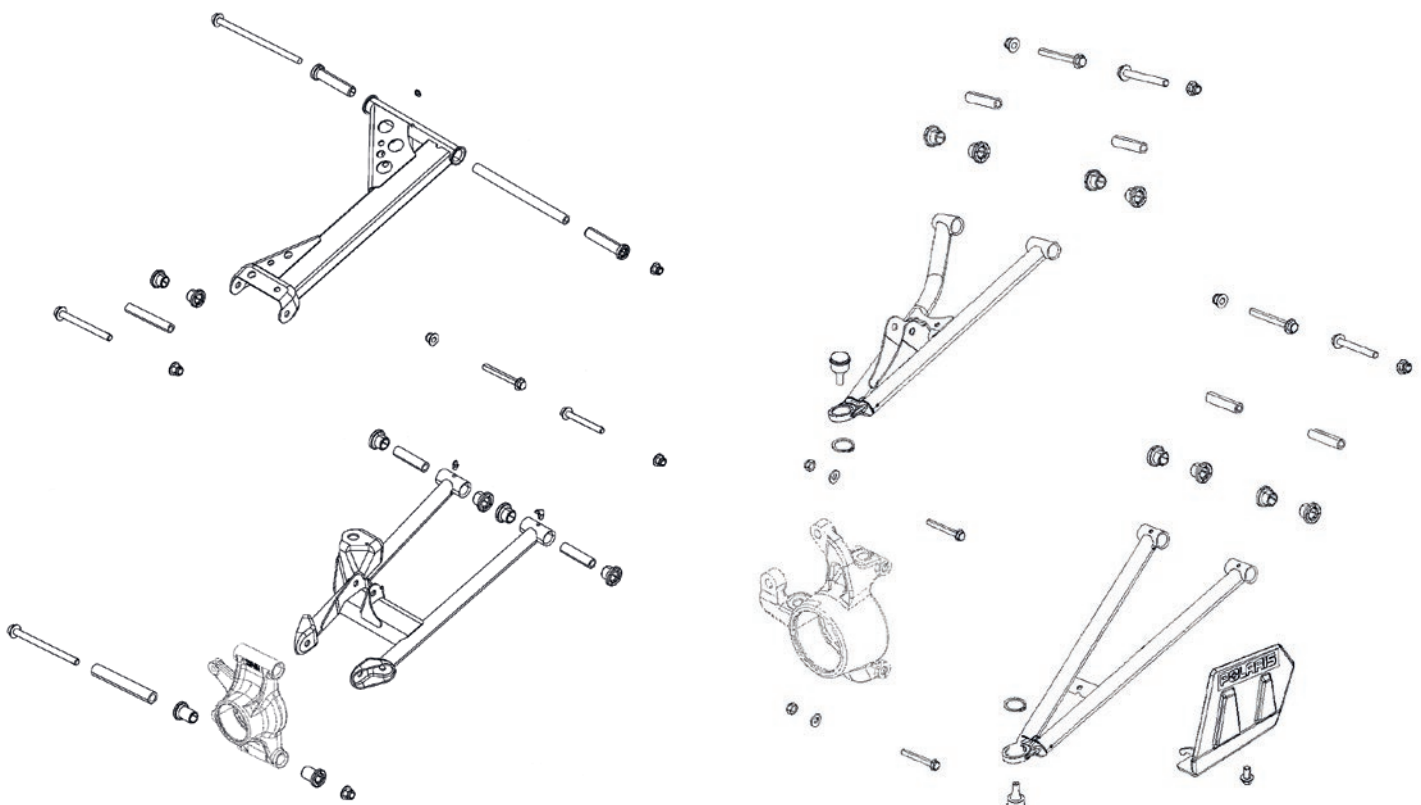

RUEDAS Y NEUMÁTICOS

MOTOR

ADMISIÓN / ESCAPE
REFRIGERACIÓN

ELECTRICO

SUSPENSIÓN / DIRECCIÓN

FRENOS

TRANSMISIÓN

CONTROLES Y MANDOS

CHASIS

ACCESORIOS

SUSPENSIÓN / DIRECCIÓN

4PLAY Kit casquillos trapecios y buje Polaris



DAT04141



DAT04142



DAT04143



DAT04144



DAT041441



DAT04145



DAT04145A



DAT04145A1



DAT04150



DAT04154



DAT04155



DAT04156



DAT04157



DAT04158



DAT04159



DAT04160



DAT04508



DAT04580



DAT04581



DAT04582

POLARIS

Año

500 Sportsman Touring	08-13
500 Sportsman X2	08-09
800 Sportsman Touring	08-09
800 Sportsman X2	08-09
800 RZR	08-14
800 RZR S	10-14
800 RZR 4	10-14

€

-



DAT04163

4PLAY Kit casquillos trapecios y buje Polaris

Referencia	Referencia Original	Medidas	Unidades	€
DAT04141	5434575	Ø Int. 16,3mm - Ø Ext. 20,7/31,5 mm - Largo 20,6/25,6mm	16	32,20
DAT04142	5434548	Ø Int. 16mm - Ø Ext. 20,9/31,7 mm - Largo 27/34,5mm	8	22,05
DAT04143	5434547 + 5132532	Ø Int. 19,5mm - Ø Ext. 24/35 mm - Largo 95/102mm Ø Int. 25,5mm - Ø Ext. 35 mm - Largo 6,3mm	4 4	35,49
DAT04144	5436832	Ø Int. 16,4mm - Ø Ext. 21/31,2 mm - Largo 24,5/30mm	8	22,05
DAT041441	5436832 / 5436505 / 5436832 / 5439732 / 5439874			
DAT04145	5434551 + 5020677	Ø Int. 16mm - Ø Ext. 20,7/31,5 mm - Largo 94/102mm Ø Int. 21,3mm - Ø Ext. 31,4 mm - Largo 6,3mm	4 4	33,68
DAT04145A	5434551	Ø Int. 16,3mm - Ø Ext. 20,7/31,5 mm - Largo 94/101,7mm	4	22,05
DAT04145A1	5431596 / 5433066 / 5434551 / 5436220 / 5436973			
DAT04150	1543326			
DAT04154	5136102			
DAT04155	5437229	Ø Int. 15,8/16,5mm - Ø Ext. 21/31,8 mm - Largo 66,6/70mm	1	4,20
DAT04156	5436798 5437651		38 2	52,60
DAT04157	5436832 5436973 5437651		28 4 4	52,60
DAT04158	5436798 5436973 5436832 5437651		24 4 4 4	52,60
DAT04159	5439874 5436973 5437651		28 4 4	52,60
DAT04160	1543367 1543326 5439874 5437651		24 4 4 4	152,44
DAT04178		Ø Int. 11,5mm - Ø Ext. 30,9 mm - Largo 48,3mm Ø Int. 31,9mm - Ø Ext. 38,3/47,6 mm - Largo 19,2/3,1mm	2 4	
DAT04508	5450095 / 5439874		2 + 6	24,22
DAT04580	5437651			
DAT04581	1543152 / 1543367			5,66
DAT04582	5436798			3,80
DAT04597	5450095	Int. 19,3mm - Ext. 22,4/28,3mm - Largo 12,5/14,1mm	1	6,16





4PLAY Kit casquillos buje trasero

Consta de todo el material necesario para la reconstrucción completa del buje de un solo lado.

ARCTIC CAT	Año	Referencia	€
Todos los ATV	10-14	DAT04550	

POLARIS	Año	Referencia	€
400 Hawkeye	11-12	DAT04178	39,92
400 Sportsman	03-05	DAT04178	39,92
400 Sportsman HO	11-12	DAT04178	39,92
450 Sportsman	06-07	DAT04178	39,92
500 Sportsman	04-12	DAT04178	39,92
600 Sportsman	03-05	DAT04178	39,92
700 Sportsman	02-07	DAT04178	39,92
800 Sportsman	05-12	DAT04178	39,92

YAMAHA	Año	Referencia	€
YFM 350 Grizzly IRS	07-13	DAT041381	37,34
YFM 400 Grizzly IRS	07-08	DAT041381	37,34
YFM 450 Kodiak	05-06	DAT041381	37,34
YFM 450 Grizzly	07-14	DAT041381	37,34
YXR 450 Rhino	06-09	DAT041381	37,34
YFM 550 Grizzly	09-14	DAT041381	37,34
YFM 660 Grizzly	02-08	DAT041381	37,34
YXR 660 Rhino	04-07	DAT041381	37,34
YFM 700 Grizzly	07-15	DAT041381	37,34
YXR 700 Rhino	08-13	DAT041381	37,34



Kit casquillos trapecios y buje trasero

Consta de todo el material necesario para la reconstrucción completa de los trapecios y buje de un lado.

ARCTIC CAT	Año	Referencia	€
400	04-13	DAT04551	16,70
450	10-12	DAT04551	16,70
500	04-13	DAT04551	16,70
550	09-13	DAT04551	16,70
650	04-12	DAT04551	16,70
700	06-13	DAT04551	16,70
1000	09-13	DAT04551	16,70

HONDA	Año	Referencia	€
TRX 650 Rincon	03-05	DAT04336	98,92
TRX 680 Rincon	06-14	DAT04336	98,92

KAWASAKI	Año	Referencia	€
KVF 650 i Brute Force	06-13	DAT04337	104,31
KVF 750 i Brute Force	05-15	DAT04337	104,31

SUZUKI	Año	Referencia	€
LT-A 450 King Quad	07-09	DAT04137	77,96
LT-A 500 king Quad	09-13	DAT04137	77,96
LT-A 700 king Quad	05-07	DAT04137	77,96

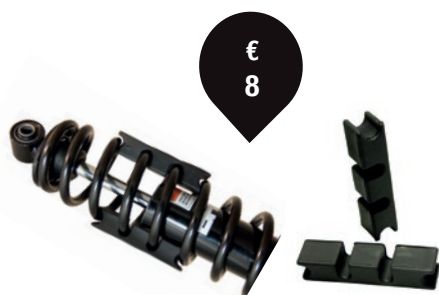

BRONCO Tope goma amortiguador

La manera más fácil y barata de endurecer los amortiguadores para los trabajos extremos donde se requiere menor recorrido de amortiguación. Palas nieve, fumigación...

Referencia	Descripción
D0429606	Muelle de Ø 8
D0429607	Muelle de Ø 10

4PLAY Bieleta amortiguador delantero Banshee

Diseñado específicamente para bajar la suspensión delantera del Banshee con un mínimo coste

Referencia	€
DAT04059	54,81



Kit reparación brazo basculante trasero

CAN AM	Año	Referencia	€
330 Outlander	04-05	DAT04552	38,57
400 Outlander	03-15	DAT04552	38,57
500 Outlander	07-12	DAT04552	38,57
500 Renegade	08-12	DAT04552	38,57
650 Outlander	06-12	DAT04552	38,57
800 Outlander	06-11	DAT04552	38,57
800 Outlander MAX	2012	DAT04552	38,57
800 Renegade	07-11	DAT04552	38,57



FRENOS



Pastillas de freno



ARCTIC CAT	Año	Lado	PASTILLAS DELANTERAS				PASTILLAS TRASERAS			
			CARBÓN / KEVLAR		SINTERIZADA		CARBÓN / KEVLAR		SINTERIZADA	
			Referencia	€	Referencia	€	Referencia	€	Referencia	€
250	2005		DAT05026	7,26	DAT05026F	16,56	DAT05026	7,26	DAT05026F	16,56
300	05-10		DAT05026	7,26	DAT05026F	16,56	DAT05026	7,26	DAT05026F	16,56
400	05-14		DAT05026	7,26	DAT05026F	16,56	DAT05026	7,26	DAT05026F	16,56
400 DVX	08-08		DAT05404	8,51	DAT05404F	15,52			DAT05508F	17,17
425	2012		DAT05026	7,26	DAT05026F	16,56	DAT05026	7,26	DAT05026F	16,56
450	10-14		DAT05026	7,26	DAT05026F	16,56	DAT05026	7,26	DAT05026F	16,56
500	05-14		DAT05026	7,26	DAT05026F	16,56	DAT05026	7,26	DAT05026F	16,56
500 Prowler	2014		DAT05026	7,26	DAT05026F	16,56	DAT05026	7,26	DAT05026F	16,56
550	11-14		DAT05026	7,26	DAT05026F	16,56	DAT05026	7,26	DAT05026F	16,56
550 Prowler	09-14		DAT05026	7,26	DAT05026F	16,56	DAT05026	7,26	DAT05026F	16,56
650	04-14		DAT05026	7,26	DAT05026F	16,56	DAT05026	7,26	DAT05026F	16,56
650 Prowler	06-09		DAT05026	7,26	DAT05026F	16,56	DAT05026	7,26	DAT05026F	16,56
700	06-14		DAT05026	7,26	DAT05026F	16,56	DAT05026	7,26	DAT05026F	16,56
700 Prowler	08-14		DAT05026	7,26	DAT05026F	16,56	DAT05026	7,26	DAT05026F	16,56
1000 Thundercat	08-14		DAT05026	7,26	DAT05026F	16,56	DAT05026	7,26	DAT05026F	16,56
1000 Prowler	10-14		DAT05026	7,26	DAT05026F	16,56	DAT05026	7,26	DAT05026F	16,56
1000 Wildcat	13-14						DAT05026	7,26	DAT05026F	16,56

CAN AM	Año	Lado	PASTILLAS DELANTERAS				PASTILLAS TRASERAS			
			CARBÓN / KEVLAR		SINTERIZADA		CARBÓN / KEVLAR		SINTERIZADA	
			Referencia	€	Referencia	€	Referencia	€	Referencia	€
200 Rally	03-07		DAT05559	9,45					E64-81380	16,45
DS 250	07-14		DAT05025	7,26	DAT05025F	19,87	DAT05025	7,26	DAT05025F	19,87
330 Outlander	04-05	Izq. Der.	DAT05611 DAT05612	9,87 9,87	E64-62291 E64-62292	15,76 15,76	DAT05611	9,87	DAT05611F	15,76
400 Outlander	03-14	Izq. Der.	DAT05611 DAT05612	9,87 9,87	E64-62291 E64-62292	15,76 15,76	DAT05611	9,87	DAT05611F	15,76
450 DS	08-14				DAT05268F	21,37			DAT05810F	19,52
500 Quest	2002	Izq. Der.	DAT05611 DAT05612	9,87 9,87	E64-62291 E64-62292	15,76 15,76	DAT05612	9,87	E64-62292	15,76
500 Traxter	99-00				E64-48886	16,30			E64-48886	16,30
500 Traxter	02-05	Izq. Der.	DAT05611 DAT05612	9,87 9,87	E64-62291 E64-62292	15,76 15,76	DAT05612	9,87	E64-62292	15,76
500 Outlander	07-12	Izq. Der.	DAT05611 DAT05612	9,87 9,87	E64-62291 E64-62292	15,76 15,76	DAT05611	9,87	DAT05611F	15,76
500 Outlander	2013	Izq. Der.	DAT05267 DAT05266	10,86 10,86	DAT05267F DAT05266F	18,50 18,50	DAT05266	10,86	DAT05266F	18,50
500 Renegade	07-12	Izq. Der.	DAT05611 DAT05612	9,87 9,87	E64-62291 E64-62292	15,76 15,76	DAT05611	9,87	DAT05611F	15,76
500 Renegade	2013	Izq. Der.	DAT05267 DAT05266	10,86 10,86	DAT05267F DAT05266F	18,50 18,50	DAT05266	10,86	DAT05266F	18,50
650 DS	00-07	Izq. Der.	DAT05611 DAT05612	9,87 9,87	E64-62291 E64-62292	15,76 15,76	DAT05611	9,87	DAT05611F	15,76
650 Outlander	06-12	Izq. Der.	DAT05611 DAT05612	9,87 9,87	E64-62291 E64-62292	15,76 15,76	DAT05611	9,87	DAT05611F	15,76
650 Outlander	2013	Izq. Der.	DAT05267 DAT05266	10,86 10,86	DAT05267F DAT05266F	18,50 18,50	DAT05266	10,86	DAT05266F	18,50
650 Traxter	04-05	Izq. Der.	DAT05611 DAT05612	9,87 9,87	E64-62291 E64-62292	15,76 15,76	DAT05612	9,87	E64-62292	15,76
800 Commander	11-14	Izq. Der.	DAT05562 DAT05561	8,14 8,14	DAT05562F DAT05561F	16,69 16,69	DAT05561	8,14	DAT05561F	16,69
800 Outlander	06-11	Izq. Der.	DAT05611 DAT05612	9,87 9,87	E64-62291 E64-62292	15,76 15,76	DAT05611	9,87	DAT05611F	15,76
800 Outlander	2013	Izq. Der.	DAT05267 DAT05266	10,86 10,86	DAT05266F DAT05267F	18,50 18,50	DAT05266	10,86	DAT05266F	18,50
800 Renegade	07-11	Izq. Der.	DAT05611 DAT05612	9,87 9,87	E64-62291 E64-62292	15,76 15,76	DAT05611	9,87	DAT05611F	15,76
800 Renegade	2012	Izq. Der.	DAT05266 DAT05267	10,86 10,86	DAT05266F DAT05267F	18,50 18,50	DAT05267	10,86	DAT05267F	18,50
1000 Commander	11-14	Izq. Der.	DAT05562 DAT05561	8,14 8,14	DAT05562F DAT05561F	16,69 16,69	DAT05561	8,14	DAT05561F	16,69
1000 Maverick	11-14	Izq. Der.	DAT05562 DAT05561	8,14 8,14	DAT05562F DAT05561F	16,69 16,69	DAT05611 DAT05612	9,87 9,87	DAT05611F DAT05612F	15,76 15,76
1000 Outlander	12-13	Izq. Der.	DAT05266 DAT05267	10,86 10,86	DAT05266F DAT05267F	18,50 18,50	DAT05611 DAT05612	9,87 9,87	DAT05611F DAT05612F	15,76 15,76
1000 Renegade	12-13	Izq. Der.	DAT05267 DAT05266	10,86 10,86	DAT05267F DAT05266F	18,50 18,50	DAT05267 DAT05266	10,86 10,86	DAT05267F DAT05266F	18,50 18,50



Pastillas de freno



CF MOTO	Año	Lado	PASTILLAS DELANTERAS				PASTILLAS TRASERAS			
			CARBÓN / KEVLAR		SINTERIZADA		CARBÓN / KEVLAR		SINTERIZADA	
			Referencia	€	Referencia	€	Referencia	€	Referencia	€
800 C8		Izq.	DAT05561	8,14	E64-71971	16,45				
		Der.	DAT05562	8,14	E64-81380	16,45				
800 Z8		Izq.	DAT05561	8,14	E64-71971	16,45				
		Der.	DAT05562	8,14	E64-81380	16,45				

GAS GAS	Año	Lado	PASTILLAS DELANTERAS				PASTILLAS TRASERAS			
			CARBÓN / KEVLAR		SINTERIZADA		CARBÓN / KEVLAR		SINTERIZADA	
			Referencia	€	Referencia	€	Referencia	€	Referencia	€
Wild 50	03-05		DMC05554	11,44	DMC05554F	17,89	DMC05554	11,44	DMC05554F	17,89
Wild 125	07-08		DMC05554	11,44	DMC05554F	17,89	DMC05554	11,44	DMC05554F	17,89
Wild 200	2008		DMC05554	11,44	DMC05554F	17,89	DMC05554	11,44	DMC05554F	17,89
Wild 240	03-05		DMC05554	11,44	DMC05554F	17,89	DMC05554	11,44	DMC05554F	17,89
Wild 250	2008		DMC05554	11,44	DMC05554F	17,89	DMC05554	11,44	DMC05554F	17,89
Wild 300	03-06		DMC05554	11,44	DMC05554F	17,89	DMC05554	11,44	DMC05554F	17,89
Wild 450	03-08		DMC05554	11,44	DMC05554F	17,89	DMC05554	11,44	DMC05554F	17,89

HONDA	Año	Lado	PASTILLAS DELANTERAS				PASTILLAS TRASERAS			
			CARBÓN / KEVLAR		SINTERIZADA		CARBÓN / KEVLAR		SINTERIZADA	
			Referencia	€	Referencia	€	Referencia	€	Referencia	€
TRX 90 Fourtrax	03-14		DAT05412M	11,44			DAT05008	8,55		
TRX 250 EX Sportrax	01-14		DAT05404	8,51	DAT05404F	15,52	E93-39185M	6,80		
TRX 250 Recon	97-14		DAT05012	10,15			E93-39185M	6,80		
TRX 300 EX Sportrax	93-11		DAT05404	8,51	DAT05404F	15,52	DAT05404	8,51	DAT05404F	15,52
TRX 300 Fourtrax	88-00		E93-39181M	6,80			E93-39163M	6,80		
TRX 350 Rancher	00-06		E93-39181M	6,80			E93-39184M	6,80		
TRX 400 EX Sportrax	99-13		DAT05404	8,51	DAT05404F	15,52	DAT05404	8,51	DAT05404F	15,52
TRX 400 Foreman	95-03		E93-39181M	6,80			E93-39184M	6,80		
TRX 400 Rancher	04-07		E93-39181M	6,80			E93-39184M	6,80		
TRX 420 Rancher 2x4	07-14		DAT05404	8,51	DAT05404F	15,52	DAT05401	13,98	DAT05401F	23,10
TRX 420 Rancher 4x4	09-14		DAT05404	8,51	DAT05404F	15,52	DAT05011	17,10		
TRX 450 Foreman	98-04		E93-39181M	6,80			E93-39184M	6,80		
TRX 450 R	04-11				E64-81381	15,63	DAT05401	13,98	DAT05401F	23,10
TRX 500 Rubicon	01-04		E93-39181M	6,80			DAT05000	14,92		
TRX 500 Rubicon	05-11		DAT05403	13,98			DAT05000	14,92		
TRX 500 Rubicon	12-13		DAT05404	8,51	DAT05404F	15,52	DAT05000	14,92		
TRX 650 Rincon	03-05		E93-39181M	6,80			DAT05401	13,98	DAT05401F	23,10
TRX 680 Rincon	06-12		DAT05403	13,98			DAT05401	13,98	DAT05401F	23,10
TRX 700 XX	08-11				E64-81381	15,63	DAT05403	13,98		

HYOSUNG	Año	Lado	PASTILLAS DELANTERAS				PASTILLAS TRASERAS			
			CARBÓN / KEVLAR		SINTERIZADA		CARBÓN / KEVLAR		SINTERIZADA	
			Referencia	€	Referencia	€	Referencia	€	Referencia	€
TE 450 S	07-10		DAT05453	8,13	E64-51866	16,30	DAT05453	8,13	E64-51866	16,30

JOHN DEERE	Año	Lado	PASTILLAS DELANTERAS				PASTILLAS TRASERAS			
			CARBÓN / KEVLAR		SINTERIZADA		CARBÓN / KEVLAR		SINTERIZADA	
			Referencia	€	Referencia	€	Referencia	€	Referencia	€
Trailback 500	04-05	Izq.	DAT05612	9,87	E64-62292	15,76	DAT05612	9,87	E64-62292	15,76
		Der.	DAT05611	9,87	E64-62291	15,76				
Trailback 650	04-05	Izq.	DAT05612	9,87	E64-62292	15,76	DAT05612	9,87	E64-62292	15,76
		Der.	DAT05611	9,87	E64-62291	15,76				

Pastillas de freno



	PASTILLAS DELANTERAS				PASTILLAS TRASERAS					
			CARBÓN / KEVLAR	SINTERIZADA			CARBÓN / KEVLAR	SINTERIZADA		
KAWASAKI	Año	Lado	Referencia	€	Referencia	€	Referencia	€	Referencia	€
KFX 50	03-05		DAT05056	7,92			DMX05258	6,09		
KFX 50	07-09		DMX05203M	6,76			DAT05023	11,76		
KFX 80	03-06		DAT05056	7,92			DAT05102	11,86		
KFX 90	07-14		DMX05203M	6,76			DAT05023	11,76		
KLF 220 Bayou	88-02		DAT05152	11,11			DAT05555	13,79		
KLF 250 Bayou	03-11		DAT05152	11,11			DAT05555	13,79		
KAF 300 Mule 550	92-03		E93-41075M	6,80			DAT05159	11,77		
KEF 300 Lakota	95-03				DAT05404F	15,52	DAT05404	8,51	DAT05404F	15,52
KLF 300 Bayou 2x4	88-04				DAT05560F	18,02	DAT05555	13,79		
KLF 300 Bayou 4x4	89-04	Izq. Der.	DAT05561 DAT05562	8,14 8,14	E64-71971 E64-81380	16,45 16,45	E93-42018M	6,80		
KVF 300 Prairie	99-02		DAT05453	8,13	E64-51866	16,30	E93-42018M	6,80		
KVF 360 Prairie	03-13		DAT05453	8,13	E64-51866	16,30	E93-42018M	6,80		
KAF 400 Mule	06-09		DAT05006	12,43			DAT05006	12,43		
KFX 400	03-06		DAT05404	8,51	DAT05404F	15,52	DAT05508	11,46	DAT05508F	17,17
KLF400 Bayou 4X4	93-99	Izq. Der.	DAT05561 DAT05562	8,14 8,14	E64-71971 E64-81380	16,45 16,45				
KVF 400 Prairie	97-02		DAT05562	8,14	E64-51866	16,30	E93-42018M	6,80		
KAF 450 Mule 1000	95-97		DAT05155	11,63			DAT05156	10,17		
KXF 450 R	08-14	Izq. Der.	DAT05016 DMX05265	12,60 12,60	DAT05016F DMX05265F	21,11 21,11	DAT05404	8,51	DAT05404F	15,52
KAF 540 Mule serie 2000	1993		DAT05155	11,63			DAT05156	10,17		
KAF 620 Mule serie 2500/3000	93-08		DAT05155	11,63			DAT05156	10,17		
KVF 650 Brute Force	05-13	Izq. Der.	DAT05016 DMX05265	12,60 12,60	DAT05016F DMX05265F	21,11 21,11				
KVF 650i Brute Force	06-13	Izq. Der.	DAT05562 DAT05561	8,14 8,14	E64-81380 E64-71971	16,45 16,45				
KVF 650 Prairie	02-03	Izq. Der.	DAT05016 DMX05265	12,60 12,60	DAT05016F DMX05265F	21,11 21,11				
KFX 700 V-Force	04-09	Izq. Der.	DAT05016 DMX05265	12,60 12,60	DAT05016F DMX05265F	21,11 21,11				
KVF 700 Prairie	04-06	Izq. Der.	DAT05016 DMX05265	12,60 12,60	DAT05016F DMX05265F	21,11 21,11				
KVF 750i Brute Force	05-14	Izq. Der.	DAT05562 DAT05561	8,14 8,14	E64-81380 E64-71971	16,45 16,45				
KRF 750 Teryx	08-13	Izq. Der.	DAT05562 DAT05561	8,14 8,14	E64-81380 E64-71971	16,45 16,45				
KRF 750 Teryx	2014	Izq. Der.	DAT05562 DAT05561	8,14 8,14	E64-81380 E64-71971	16,45 16,45				
KAF 950 Mule Diesel	03-08		DAT05155	11,63			DAT05156	10,17		
			CARBÓN / KEVLAR		SINTERIZADA		CARBÓN / KEVLAR		SINTERIZADA	
KYMCO	Año	Lado	Referencia	€	Referencia	€	Referencia	€	Referencia	€
MXer 50	04-08		DAT05014	8,21			DAT05024	13,05		
MXer 50 (disco trasero)	08-09		DAT05014	8,21			DAT05023	11,76		
MXer 70 Mongoose	07-14		DAT05014	8,21			DAT05023	11,76		
MXer 90 Mongoose	02-14		DAT05412M	11,44			DAT05023	11,76		
MXer 150	03-05		DAT05412M	11,44			DAT05023	11,76		
MXU 150	05-14		DAT05412M	11,44			DAT05023	11,76		
KXR 250	04-09		DAT05025	7,26	DAT05025F	19,87	DAT05013	10,18	DAT05013F	19,39
MXU 250	04-10		DAT05025	7,26	DAT05025F	19,87	DAT05013	10,18	DAT05013F	19,39
Mongoose 300	06-14		DAT05025	7,26	DAT05025F	19,87	DAT05013	10,18	DAT05013F	19,39
Maxxer 300	06-08		DAT05025	7,26	DAT05025F	19,87	DAT05013	10,18	DAT05013F	19,39
MXU 300	05-14		DAT05025	7,26	DAT05025F	19,87	DAT05025	7,26	DAT05025F	19,87
MXU 375 IRS	08-12		DAT05026	7,26	DAT05026F	16,56	DAT05026	7,26	DAT05026F	16,56
Maxxer 450 IRS	11-14		DAT05026	7,26	DAT05026F	16,56	DAT05026	7,26	DAT05026F	16,56
MXU 450 IRS	11-14		DAT05026	7,26	DAT05026F	16,56	DAT05026	7,26	DAT05026F	16,56
MXU 500	06-11		DAT05025	7,26	DAT05025F	19,87	DAT05025	7,26	DAT05025F	19,87
MXU 500i	09-13				DAT05274F	18,52			DAT05274F	18,52
MXU 550	12-13				DAT05274F	18,52			DAT05274F	18,52
MXU 700	13-14				DAT05274F	18,52			DAT05274F	18,52



Pastillas de freno



POLARIS	Año	Lado	PASTILLAS DELANTERAS		PASTILLAS TRASERAS					
			CARBÓN / KEVLAR	SINTERIZADA	CARBÓN / KEVLAR	SINTERIZADA				
			Referencia	€	Referencia	€	Referencia	€	Referencia	€
Outlaw 50	08-14		DAT05014	9,92			DAT05054	8,55		
Predator 50	04-06		DAT05014	9,92			DAT05054	8,55		
Scrambler 50	01-03		DAT05014	9,92			DAT05054	8,55		
Outlaw 90	07-13		DAT05014	9,92			DAT05054	8,55		
Predator 90	03-06		DAT05014	9,92			DAT05054	8,55		
Scrambler 90	01-03		DAT05014	9,92			DAT05054	8,55		
Sportsman 90	01-13		DAT05014	9,92			DAT05054	8,55		
Phoenix 200 (mordaza)	05-14		DAT05559	9,45						
Phoenix 200 (disco)	05-08		DAT05559	9,45			DAT05559	9,45		
Sawtooth 200 (disco)	06-07		DAT05559	9,45			DAT05559	9,45		
Trail Blazer 250	90-98		DAT05654	8,53	DAT05654F	14,65			E64-48891	16,30
Trail Blazer 250	99-04		DAT05654	8,53	DAT05654F	14,65			DAT05657F	15,41
Trail Blazer 250	05-06		DAT05654	8,53	DAT05654F	14,65	DAT05015	12,60	DAT05015F	17,78
Trail Boss 250	91-99		DAT05654	8,53	DAT05654F	14,65			E64-48891	16,30
Xplorer 250	2000		DAT05654	8,53	DAT05654F	14,65			DAT05657F	15,41
Hawkeye 300	2006		DAT05026	7,26	DAT05026F	16,56	DAT05026	7,26	DAT05026F	16,56
Hawkeye 300	07-09		DAT05654	8,53	DAT05654F	14,65	DAT05026	7,26	DAT05026F	16,56
Sportsman 300	08-10		DAT05654	8,53	DAT05654F	14,65	DAT05654	8,53	DAT05654F	14,65
Xpress 300	96-97		DAT05654	8,53	DAT05654F	14,65			E64-48891	16,30
Magnum 325	00-01		DAT05654	8,53	DAT05654F	14,65			DAT05657F	15,41
Magnum 325	2002		DAT05654	8,53	DAT05654F	14,65	DAT05015	12,60	DAT05015F	17,78
Xpedition 325	2000		DAT05654	8,53	DAT05654F	14,65			DAT05657F	15,41
Xpedition 325	2002		DAT05654	8,53	DAT05654F	14,65			DAT05015F	17,78
Trail Boss 325	00-02		DAT05654	8,53	DAT05654F	14,65			DAT05657F	15,41
Magnum 330	03-06		DAT05654	8,53	DAT05654F	14,65	DAT05015	12,60	DAT05015F	17,78
Trail Boss 330	03-04		DAT05654	8,53	DAT05654F	14,65			DAT05657F	15,41
Trail Boss 330	05-13		DAT05654	8,53	DAT05654F	14,65			DAT05015F	17,78
Trail Blazer 330	08-13		DAT05654	8,53	DAT05654F	14,65			DAT05015F	17,78
Sportsman 335	99-00		DAT05654	8,53	DAT05654F	14,65			DAT05657F	15,41
Hawkeye 400	13-14		DAT05654	8,53	DAT05654F	14,65	DAT05038	12,60	DAT05038F	16,45
Scrambler 400	95-97		DAT05654	8,53	DAT05654F	14,65			E64-48891	16,30
Scrambler 400	98-02		DAT05654	8,53	DAT05654F	14,65			DAT05657F	15,41
Xplorer 400	95-98		DAT05654	8,53	DAT05654F	14,65			E64-48891	16,30
Xplorer 400	99-02		DAT05654	8,53	DAT05654F	14,65			DAT05657F	15,41
Sport 400L	94-98		DAT05654	8,53	DAT05654F	14,65			E64-48891	16,30
Sport 400L	99-00		DAT05654	8,53	DAT05654F	14,65			DAT05657F	15,41
Sportsman 400L	94-97		DAT05654	8,53	DAT05654F	14,65			E64-48891	16,30
Sportsman 400	01-02		DAT05654	8,53	DAT05654F	14,65			DAT05657F	15,41
Sportsman 400	03-04		DAT05654	8,53	DAT05654F	14,65	DAT05015	12,60	DAT05015F	17,78
Sportsman 400	08-10		DAT05654	8,53	DAT05654F	14,65	DAT05654	8,53	DAT05654F	14,65
Sportsman 400	11-14		DAT05654	8,53	DAT05654F	14,65	DAT05038	12,60	DAT05038F	16,45
Trail Blazer 400	2003		DAT05654	8,53	DAT05654F	14,65			DAT05657F	15,41
Magnum 425	95-98		DAT05654	8,53	DAT05654F	14,65			E64-48891	16,30
Outlaw S 450	09-10		DAT05419	15,23	DAT05419F	16,07	DAT05654	8,53	DAT05654F	14,65
Sportsman 450	06-07		DAT05654	8,53	DAT05654F	14,65	DAT05015	12,60	DAT05015F	17,78
Magnum 500	99-01		DAT05654	8,53	DAT05654F	14,65			DAT05657F	15,41
Magnum 500	02-03		DAT05654	8,53	DAT05654F	14,65	DAT05015	12,60	DAT05015F	17,78
Scrambler 500	1997		DAT05654	8,53	DAT05654F	14,65			E64-48891	16,30
Scrambler 500	98-04		DAT05654	8,53	DAT05654F	14,65			DAT05657F	15,41
Scrambler 500	05-13		DAT05654	8,53	DAT05654F	14,65	DAT05015	12,60	DAT05015F	17,78
Outlaw 500	06-07		DAT05654	8,53	DAT05654F	14,65	DAT05654	8,53	DAT05654F	14,65
Predator 500	03-07		DAT05654	8,53	DAT05654F	14,65	DAT05654	8,53	DAT05654F	14,65
Xplorer 500	1997		DAT05654	8,53	DAT05654F	14,65			E64-48891	16,30
Sportsman 500	96-97		DAT05654	8,53	DAT05654F	14,65			E64-48891	16,30
Sportsman 500	98-02		DAT05654	8,53	DAT05654F	14,65			DAT05657F	15,41
Sportsman 500	03-08		DAT05654	8,53	DAT05654F	14,65	DAT05015	12,60	DAT05015F	17,78
Sportsman 500 X2	07-09		DAT05654	8,53	DAT05654F	14,65	DAT05654	8,53	DAT05654F	14,65
Sportsman 500 Forest	2012		DAT05654	8,53	DAT05654F	14,65	DAT05015	12,60	DAT05015F	17,78
Sportsman 500 Touring	08-11		DAT05654	8,53	DAT05654F	14,65	DAT05654	8,53	DAT05654F	14,65
Sportsman 500 Touring	12-13		DAT05654	8,53	DAT05654F	14,65	DAT05019		DAT05019F	16,16
Sportsman 500 EFI	08-11		DAT05654	8,53	DAT05654F	14,65	DAT05015	12,60	DAT05015F	17,78

RUEDAS Y NEUMÁTICOS
MOTOR
ADMISIÓN / ESCAPE REFRIGERACIÓN
ELECTRICO
SUSPENSIÓN / DIRECCIÓN
FRENOS
TRANSMISIÓN
CONTROLES Y MANDOS
CHASIS
ACCESORIOS

Pastillas de freno

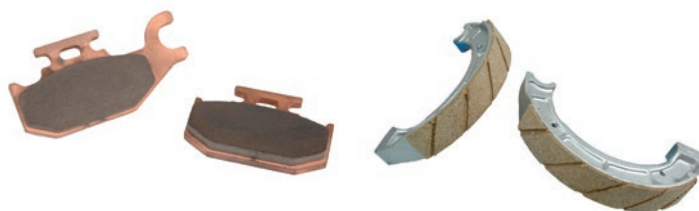

		PASTILLAS DELANTERAS				PASTILLAS TRASERAS			
		CARBÓN / KEVLAR		SINTERIZADA		CARBÓN / KEVLAR		SINTERIZADA	
Sportsman 500 XP	2009	DAT05038	12,60	DAT05038F	16,45	DAT05038	12,60	DAT05038F	16,45
Outlaw 525	08-11	DAT05419	15,23	DAT05419F	16,07	DAT05015	12,60	DAT05015F	17,78
Sportsman 550 XP	09-14	DAT05038	12,60	DAT05038F	16,45	DAT05038	12,60	DAT05038F	16,45
Sportsman 570	11-14	DAT05654	8,53	DAT05654F	14,65	DAT05038	12,60	DAT05038F	16,45
Sportsman 600	03-05	DAT05654	8,53	DAT05654F	14,65	DAT05015	12,60	DAT05015F	17,78
Sportsman 700	02-08	DAT05654	8,53	DAT05654F	14,65	DAT05015	12,60	DAT05015F	17,78
Sportsman 800 EFI	05-09	DAT05654	8,53	DAT05654F	14,65	DAT05015	12,60	DAT05015F	17,78
Sportsman 800 EFI	10-14	DAT05654	8,53	DAT05654F	14,65	DAT05038	12,60	DAT05038F	16,45
Sportsman 800 X2	07-09	DAT05654	8,53	DAT05654F	14,65	DAT05015	12,60	DAT05015F	17,78
Sportsman 800 Forest	2012	DAT05038	12,60	DAT05038F	16,45	DAT05038	12,60	DAT05038F	16,45
RZR 800	08-14	DAT05419	15,23	DAT05419F	16,07	DAT05654	8,53	DAT05654F	14,65
RZR "S" 800	09-13	DAT05419	15,23	DAT05419F	16,07	DAT05654	8,53	DAT05654F	14,65
RZR 800 "4"	10-13			DAT05039F	22,86			DAT05019F	16,16
Sportsman 850 XP	09-14	DAT05038	12,60	DAT05038F	16,45	DAT05038	12,60	DAT05038F	16,45
RZR 900 XP (incluido EPS)	11-14			DAT05039F	22,86			DAT05019F	16,16
RZR 900 XP	15-16			DAT05278F	23,10				
RZR 900 XP "4"	13-14			DAT05039F	22,86			DAT05039F	22,86
RZR 1000 XP	2014			DAT05039F	22,86			DAT05039F	22,86

		PASTILLAS DELANTERAS				PASTILLAS TRASERAS				
		CARBÓN / KEVLAR		SINTERIZADA		CARBÓN / KEVLAR		SINTERIZADA		
SUZUKI	Año	Lado	Referencia	€	Referencia	€	Referencia	€	Referencia	€
LT-A 50 QuadSport	02-05		DAT05056	7,92			DMX05258	6,09		
LT-Z 50 QuadSport	06-11		DAT05056	7,92			DMX05258	6,09		
LT 80 QuadSport	87-06		DAT05056	7,92			DAT05102	11,86		
LT-Z 90 QuadSport	07-14		DMX05258	6,09			DAT05102	11,86		
LT-F 160 Quadrunner	89-04		DAT05104M	7,87			E93-42006M	6,80		
LT-F 250 Ozark	02-14		DAT05453	8,13	E64-51866	16,30	DAT05406	22,29		
LT-F 250 Quadrunner	89-02		E93-41075M	6,80			E93-41073M	11,50		
LT-Z 250 QuadSport	04-09				DAT05400F		DAT05406	22,29		
LT-F 300 King Quad	99-01						E93-41057M	11,50		
LT-F 300 King Quad	2002	Izq. Der.	DAT05562 DAT05561	8,14 8,14	E64-81380 E64-71971	16,45 16,45	E93-41057M	11,50		
LT-A 400 Eiger	02-07		DAT05453	8,13	E64-51866	16,30	DMC05276M	12,60		
LT-F 400 Eiger	02-07		DAT05453	8,13	E64-51866	16,30	DMC05276M	12,60		
LT-A 400 King Quad	08-09	Izq. Der.	DAT05032 DAT05033	12,18 12,18	DAT05032F DAT05033F	21,20 21,20	DMC05276M	12,60		
LT-F 400 King Quad	11-14	Izq. Der.	DAT05032 DAT05033	12,18 12,18	DAT05032F DAT05033F	21,20 21,20	DMC05276M	12,60		
LT-Z 400 QuadSport	03-14		DAT05404	8,51	DAT05404F	15,52	DAT05508	11,46	DAT05508F	17,17
LT-A 450i King Quad	07-11	Izq. Der.	DAT05032 DAT05033	12,18 12,18	DAT05032F DAT05033F	21,20 21,20				
LT-R 450	06-11	Izq. Der.	DAT05561 DAT05562	8,14 8,14	E64-71971 E64-81380	16,45 16,45	DAT05508	11,46	DAT05508F	17,17
LT-A 500 King Quad	09-14	Izq. Der.	DAT05032 DAT05033	12,18 12,18	DAT05032F DAT05033F	21,20 21,20				
LT-A 500 Quadrunner	00-01	Izq. Der.	DAT05561 DAT05562	8,14 8,14	E64-71971 E64-81380	16,45 16,45	E93-41057M	11,50		
LT-F 500 Quadrunner	98-02	Izq. Der.	DAT05561 DAT05562	8,14 8,14	E64-71971 E64-81380	16,45 16,45	E93-41057M	11,50		
LT-A 500 Vinson	2002		DAT05453	8,13	E64-51866	16,30	DAT05612	9,87	E64-62292	15,76
LT-A 500 Vinson	03-07		DAT05453	8,13	E64-51866	16,30	DAT05017	11,07	DAT05017F	18,58
LT-F 500 Vinson	04-07		DAT05453	8,13	E64-51866	16,30	DAT05017	11,07	DAT05017F	18,58
LT-A 700 King Quad	05-11	Izq. Der.	DAT05032 DAT05033	12,18 12,18	DAT05032F DAT05033F	21,20 21,20				
LT-V 700 Twin Peaks	04-05	Izq. Der.	DAT05016 DMX05265	12,60 12,60	DAT05016F DMX05265F	21,11 21,11				
LT-A 750i King Quad	08-14	Izq. Der.	DAT05032 DAT05033	12,18 12,18	DAT05032F DAT05033F	21,20 21,20				

		PASTILLAS DELANTERAS				PASTILLAS TRASERAS				
		CARBÓN / KEVLAR		SINTERIZADA		CARBÓN / KEVLAR		SINTERIZADA		
SYM	Año	Lado	Referencia	€	Referencia	€	Referencia	€	Referencia	€
Quadlander 300	07-10		DAT05025	7,26	DAT05025F	19,87	DAT05025	7,26	DAT05025F	19,87
Quadlander 600	08-10		DAT05453	8,13	E64-51866	16,30	DAT05025	7,26	DAT05025F	19,87



Pastillas de freno

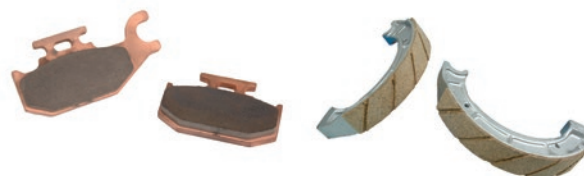

YAMAHA	Año	Lado	PASTILLAS DELANTERAS				PASTILLAS TRASERAS			
			CARBÓN / KEVLAR		SINTERIZADA		CARBÓN / KEVLAR		SINTERIZADA	
			Referencia	€	Referencia	€	Referencia	€	Referencia	€
YFM 50 Raptor	04-08		DAT05653M	8,75			DAT05462M	9,13		
YFM 80 Badger	92-01		DAT05653M	8,75			DAT05462M	9,13		
YFM 80 Raptor	02-08		DAT05653M	8,75			DAT05462M	9,13		
YFM 80 Grizzly	05-08		DAT05653M	8,75			DAT05462M	9,13		
YFM 90 Raptor	09-13		DAT05058	9,24					DAT05560F	
YFA 125 Brezze	92-04		DAT05653M	8,75			DAT05462M	9,13		
YFM 125 Grizzly	04-13		DAT05653M	8,75			DAT05462M	9,13		
YFM 125 Raptor	11-13		DAT05453	8,13	E64-51866	16,30	DAT05404	8,51	DAT05404F	15,52
YFS 200 Blaster	88-02		DAT05653M	8,75			DAT05455	10,39		
YFS 200 Blaster	03-06		DAT05453	8,13	E64-51866	16,30	DAT05404	8,51	DAT05404F	15,52
YFB 250 Timberwolf	92-94		DAT05653M	8,75			E93-27228M	6,80		
YFB 250 Timberwolf	95-00		E93-27228M	6,80			E93-27228M	6,80		
YFM 250 Bear Tracker	99-00		E93-27228M	6,80			E93-27228M	6,80		
YFM 250 Bear Tracker	01-04		DAT05453	8,13	E64-51866	16,30	E93-27228M	6,80		
YFM 250 Bruin	05-06		DAT05453	8,13	E64-51866	16,30	DAT05408M	25,37		
YFM 250 Big Bear	07-09		DAT05453	8,13	E64-51866	16,30	DAT05408M	25,37		
YFM 250 Raptor	08-13	Izq. Der.	DAT05028 DAT05027	11,76 11,76	DAT05028F DAT05027F	18,27 18,27	DAT05404	8,51	DAT05404F	15,52
YFM 350 Big Bear semi.	96-98		E93-27220M	6,80			E93-27209M	8,90		
YFM 350 Bruin	04-06		DAT05453	8,13	E64-51866	16,30	DAT05408M	25,37		
YFM 350 Grizzly	07-16		DAT05453	8,13	E64-51866	16,30	DAT05408M	25,37		
YFM 350 Grizzly IRS	07-11		DAT05453	8,13	E64-51866	16,30				
YFM 350 Raptor	04-13		DAT05404	8,51	DAT05404F	15,52	DAT05404	8,51	DAT05404F	15,52
YFM 350 Warrior	89-04		DAT05453	8,13	E64-51866	16,30	DAT05404	8,51	DAT05404F	15,52
YFM 350 Wolverine semi.	95-05		DAT05453	8,13	E64-51866	16,30	DAT05404	8,51	DAT05404F	15,52
YFM 350 Wolverine	06-09		DAT05453	8,13	E64-51866	16,30	DAT05408M	25,37		
YFZ 350 Banshee	90-06		DAT05453	8,13	E64-51866	16,30	DAT05404	8,51	DAT05404F	15,52
YFM 400 Big Bear PRO	00-06		DAT05453	8,13	E64-51866	16,30	DAT05611	9,87	DAT05611F	15,76
YFM 400 Grizzly IRS	07-08		DAT05453	8,13	E64-51866	16,30	DAT05611	9,87	DAT05611F	15,76
YFM 400 Kodiak semi.	93-99		E93-27220M	6,80			E93-27209M	8,90		
YFM 400 Kodiak	00-06		DAT05453	8,13	E64-51866	16,30	DAT05611	9,87	DAT05611F	15,76
YFM 450 Grizzly	07-08		DAT05453	8,13	E64-51866	16,30	DAT05611	9,87	DAT05611F	15,76
YFM 450 Grizzly	09-14		DAT05453	8,13	E64-51866	16,30				
YFM 450 Kodiak	04-06		DAT05453	8,13	E64-51866	16,30	DAT05611	9,87	DAT05611F	15,76
YFM 450 Wolverine	06-11		DAT05453	8,13	E64-51866	16,30	DAT05611	9,87	DAT05611F	15,76
YFZ 450	04-05	Izq. Der.	DAT05561 DAT05562	8,14 8,14	E64-71971 E64-81380	16,45 16,45	DAT05404	8,51	DAT05404F	15,52
YFZ 450	06-14	Izq. Der.	DAT05561 DAT05562	8,14 8,14	E64-71971 E64-81380	16,45 16,45			DAT05024F	15,80
YFZ 450 R	09-16	Izq. Der.	DAT05561 DAT05562	8,14 8,14	E64-71971 E64-81380	16,45 16,45			DAT05024F	15,80
YXR 450 Rhino	06-09	Izq. Der.	DAT05561 DAT05562	8,14 8,14	E64-71971 E64-81380	16,45 16,45	DAT05021	12,91	E64-62292	15,76
YFM 550 Grizzly	09-14	Izq. Der.	DAT05028 DAT05027	11,76 11,76	DAT05028F DAT05027F	18,27 18,27	DAT05030 DAT05029	11,76 11,76	DAT05030F DAT05029F	17,65 17,65
YFM 600 Grizzly	98-01		DAT05404	8,51	DAT05404F	15,52	E93-27209M	8,90		
YFM 660 Grizzly	02-08		DAT05404	8,51	DAT05404F	15,52	DAT05420	13,98		
YFM 660 Raptor	01-05		DAT05404	8,51	DAT05404F	15,52	DAT05404	8,51	DAT05404F	15,52
YXR 660 Rhino	03-07	Izq. Der.	DAT05561 DAT05562	8,14 8,14	E64-71971 E64-81380	16,45 16,45	DAT05021	12,91	E64-62292	15,76
YFM 700 Grizzly	07-16	Izq. Der.	DAT05028 DAT05027	11,76 11,76	DAT05028F DAT05027F	18,27 18,27	DAT05030 DAT05029	11,76 11,76	DAT05030F DAT05029F	17,65 17,65
YFM 700 Kodiak	2016	Izq. Der.	DAT05028 DAT05027	11,76 11,76	DAT05028F DAT05027F	18,27 18,27	DAT05030 DAT05029	11,76 11,76	DAT05030F DAT05029F	17,65 17,65
YFM 700 Raptor	06-12	Izq. Der.	DAT05561 DAT05562	8,14 8,14	E64-71971 E64-81380	16,45 16,45	DAT05021	12,91	E64-62292	15,76
YFM 700 Raptor	13-16	Izq. Der.	DAT05561 DAT05562	8,14 8,14	E64-71971 E64-81380	16,45 16,45			DAT05024F	15,80
YXE 700 Wolverine	16-17	Izq. Der.			DAT05276F DAT05277F	19,86 19,86				
YXM 700 Viking	14-17	Izq. Der.			DAT05276F DAT05277F	19,86 19,86				
YXR 700 Rhino	08-14	Izq. Der.	DAT05561 DAT05562	8,14 8,14	E64-71971 E64-81380	16,45 16,45	DAT05561 DAT05562	8,14 8,14	E64-71971 E64-81380	16,45 16,45

RUEDAS Y NEUMÁTICOS

MOTOR

ADMISIÓN / ESCAPE
REFRIGERACIÓN

ELÉCTRICO

SUSPENSIÓN / DIRECCIÓN

FRENOS

TRANSMISIÓN

CONTROLES Y MANDOS

CHASIS

ACCESORIOS

XPEED Discos de freno

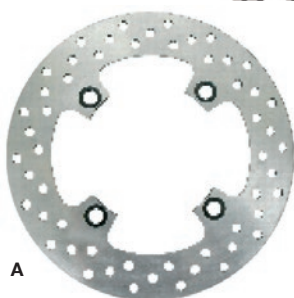

A



B

			DELANTERO		TRASERO	
HONDA	Año	Modelo	Referencia	€	Referencia	€
TRX 250 R	89-92	A	R8102FA	41,61	R8102RA	53,64
TRX 300 Sportrax	93-09	A	R8101FA	41,61		
		B	R8101FB	41,61		
TRX 400 Sportrax	99-09	A	R8101FA	41,61	R8101RA	53,64
		B	R8101FB	41,61	R8101RB	53,64
TRX 450 R	04-08	A	R8101FA	41,61		
		B	R8101FB	41,61		

			DELANTERO		TRASERO	
SUZUKI	Año	Modelo	Referencia	€	Referencia	€
LTZ 250	04-08	A	R8401FA	41,61	R8401RA	53,64
		B	R8401FB	41,61	R8401RB	53,64
LTZ 400	03-09	A	R8401FA	41,61	R8401RA	53,64
		B	R8401FB	41,61	R8401RB	53,64
LTR 450	06-08	A	R8402FA	41,61		
		B	R8402FB	41,61		

			DELANTERO		TRASERO	
YAMAHA	Año	Modelo	Referencia	€	Referencia	€
YFS 200 Blaster	03-06	A	R8301FA	41,61	R8301RA	53,64
		B	R8301FB	41,61	R8301RB	53,64
YFM 250 Raptor	08-10	A	R8301FA	41,61		
		B	R8301FB	41,61		
YFM 250 Bruin	01-08	A	R8301FA	41,61		
		B	R8301FB	41,61		
YFM 350 Raptor	05-12	A	R8301FA	41,61	R8302RA	53,64
		B	R8301FB	41,61	R8302RB	53,64
YFM 350 Warrior	89-04	A	R8301FA	41,61	R8304RA	53,64
		B	R8301FB	41,61	R8304RB	53,64
YFZ 350 Banshee	91-08	A	R8301FA	41,61	R8301RA	53,64
		B	R8301FB	41,61	R8301RB	53,64
YFM 400 Kodiak	00-02	A	R8301FA	41,61	R8301RA	53,64
		B	R8301FB	41,61	R8301RB	53,64
YFZ 450	04-05	A	R8301FA	41,61	R8302RA	53,64
		B	R8301FB	41,61	R8302RB	53,64
YFZ 450	06-08	A	R8301FA	41,61	R8303RA	53,64
		B	R8301FB	41,61	R8303RB	53,64
YFM 660 Raptor	01-05	A	R8301FA	41,61	R8301RA	53,64
		B	R8301FB	41,61	R8301RB	53,64
YFM 660 Grizzly	02-06	A	R8401RA	53,64		
		B	R8401RB	53,64		
YFM 700 Raptor	06-09	A	R8301FA	41,61	R8303RA	53,64
		B	R8301FB	41,61	R8303RB	53,64



BRONCO

Kit reparación pinza de freno

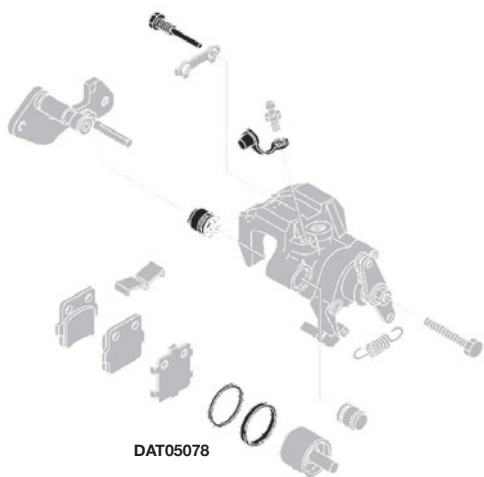

DAT05078



DAT05071

HONDA	Año	DELANTERO		TRASERO	
		Referencia	€	Referencia	€
TRX 250 EX Sportrax	01-09	DAT05060	17,56		
TRX 300 EX Sportrax	93-09	DAT05060	17,56	DAT05073	
TRX 400 EX Sportrax	99-09	DAT05060	17,56	DAT05073	
TRX 420	07-12	DAT05062	17,56		
TRX 450 R	04-12	DAT05063	17,56	DAT05075	
TRX 500 Foreman	05-11	DAT05064	19,16		
TRX 500 Rubicon	05-12	DAT05064	19,16		
TRX 650 Rincon	03-05			DAT05076	
TRX 680 Rincon	06-12	DAT05064	19,16	DAT05076	
TRX 700 XX	08-09	DAT05063	17,56	DAT05075	

KAWASAKI	Año	DELANTERO		TRASERO	
		Referencia	€	Referencia	€
KVF 300 Prairie	99-02	DAT05065	16,63		
KVF 360 Prairie	03-13	DAT05065	16,63		
KVF 400 Prairie	97-02	DAT05065	16,63		
KLF 400 Bayou	93-99	DAT05066	16,10		
KVF 650 Brute Force	06-09	DAT05066	16,10		
KRF 750 Teryx	08-09	DAT05066	16,10		
KVF 750 Brute Force	05-12	DAT05066	16,10		

SUZUKI	Año	DELANTERO		TRASERO	
		Referencia	€	Referencia	€
LT-F 250 Ozark	02-09	DAT05043	18,65		
LT-Z 250 QuadSport	04-09	DAT05043	18,65		
LT-F 400 Eiger	02-07	DAT05043	18,65		
LT-F 400 Eiger	2008	DAT05067	18,22		
LT-Z 400	03-09	DAT05043	18,65		
LT-A 400	02-07	DAT05043	18,65		
LT-F 400	02-07	DAT05043	18,65		
LT-A 450 King Quad	07-08	DAT05067	18,22		
LT-R 450 Quadracer	06-08	DAT05068	18,22		
LT-A 500 Vinson	00-01	DAT05068	18,22		
LT-A 500 King Quad	02-07	DAT05043	18,65		
LT-F 500 Quadranner	98-02	DAT05068	18,22		
LT-F 500 Vinson	2003	DAT05043	18,65		
LT-F 500 King Quad	04-07	DAT05043	18,65		
LT-A 700 King Quad	06-07	DAT05067	18,22		
LT-A 750 King Quad	2008	DAT05067	18,22		

YAMAHA	Año	DELANTERO		TRASERO	
		Referencia	€	Referencia	€
YFM 250 Bruin	05-09	DAT05069	15,44		
YFS 200 Blaster	04-06	DAT05069	15,44	DAT05077	
YFM 250 Raptor	08-09	DAT05070	14,12	DAT05078	
YFM 250 Raptor	10-12	DAT05070	14,12	DAT05077	
YFM 250 Beartracker	01-04	DAT05069	15,44		
YFM 350 Bruin	04-06	DAT05069	15,44		
YFM 350 Big Bear	1999	DAT05069	15,44		
YFM 350 Grizzly	07-12	DAT05069	15,44		
YFM 350 Wolverine	95-05	DAT05069	15,44	DAT05079	
YFM 350 R	04-12	DAT05069	15,44	DAT05078	
YFM 350 Warrior	87-04	DAT05069	15,44	DAT05079	
YFZ 350 Banshee	90-06	DAT05069	15,44	DAT05079	
YFM 400 Grizzly	00-12	DAT05069	15,44		
YFM 400 Kodiak	1999	DAT05069	15,44		
YFM 400 Kodiak	00-06	DAT05069	15,44	DAT05080	
YFM 450 Kodiak	03-06	DAT05069	15,44	DAT05080	
YFM 450 Grizzly	2007	DAT05069	15,44	DAT05080	
YFM 450 Grizzly	08-12	DAT05069	15,44		
YFM 450 Wolverine	06-10	DAT05069	15,44	DAT05080	
YFZ 450	04-05	DAT05071	17,56	DAT05078	
YFZ 450	06-09	DAT05071	17,56	DAT05081	
YFZ 450 R	09-12	DAT05071	17,56	DAT05081	
YFM 550 Grizzly	09-14	DAT05070	14,12	DAT05082	
YFM 600 Grizzly	98-01	DAT05072	16,90		
YFM 660 Grizzly	02-08	DAT05072	16,90	DAT05083	
YFM 660 Raptor	01-05	DAT05069	15,44	DAT05077	
YFM 700 Grizzly	07-14	DAT05070	14,12	DAT05082	
YFM 700 Raptor	06-12	DAT05071	17,56	DAT05084	

RUEDAS Y NEUMÁTICOS

MOTOR

ADMISIÓN / ESCAPE
REFRIGERACIÓN

ELECTRICO

SUSPENSIÓN / DIRECCIÓN

FRENOS

TRANSMISIÓN

CONTROLES Y MANDOS

CHASIS

ACCESORIOS

BRONCO Kit reparación bomba de freno

HONDA	Año	DELANTERO		TRASERO	
		Referencia	€	Referencia	€
TRX 250 Recon	97-16	DAT05854	15,31		
TRX 250 EX Sportrax	01-16	DAT05854	15,31		
TRX 300 EX Sportrax	93-04	DAT05851	17,42	DAT05853	21,20
TRX 300 EX Sportrax	05-09	DAT05854	15,31	DAT05853	21,20
TRX 350 Rancher	00-03	DAT05854	15,31		
TRX 350 Rancher	04-06	DAT05855	14,26		
TRX 400 EX Sportrax	99-14	DAT05854	15,31		
TRX 400 Foreman	95-03	DAT05852	14,65		
TRX 400 Foreman	04-07	DAT05855	14,26		
TRX 420 Rancher	07-08	DAT05855	14,26		
TRX 450 Rancher	98-01	DAT05852	14,65		
TRX 450 Rancher	02-04	DAT05852	14,65		
TRX 450 R	04-14	DAT05856	20,20	DAT05853	21,20
TRX 500 Rubicon	01-03	DAT05852	14,65		
TRX 500 Rubicon	2004	DAT05852	14,65		
TRX 500 Rubicon	05-08	DAT05855	14,26		
TRX 650 Rincon	03-06	DAT05855	14,26		
TRX 680 Rincon	03-15	DAT05855	14,26		
TRX 700 XX	08-09	DAT05856	20,20	DAT05853	21,20

KAWASAKI	Año	DELANTERO		TRASERO	
		Referencia	€	Referencia	€
KSF 250	87-04	DAT05861	17,95	DAT05853	21,20
KEF 300 LAKOTA	95-03	DAT05861	17,95	DAT05853	21,20
KLF 300B Bayou	88-04	DAT05861	17,95		
KLF 300C Bayou	89-05	DAT05861	17,95		
KVF 300 Prairie	99-02	DAT05861	17,95		
KVF 360 Prairie	03-13	DAT05861	17,95		
KVF 360B Prairie	03-10	DAT05861	17,95		
KLF 400 Bayou	93-99	DAT05861	17,95		
KVF 400 Prairie	97-98	DAT05861	17,95		
KVF 400 Prairie	99-02	DAT05861	17,95		
KFX 400	03-06	DMX05621	20,86		
KFX 450 R	08-14	DAT05857		DAT05853	21,20
KVF 650 Brute Force	05-13	DAT05861	17,95		
KVF 650 Brute Force	06-13	DAT05858			
KVF 650 Prairie	02-03	DAT05861	17,95		
KFX 700 V-Force	04-09	DAT05861	17,95		
KVF 700 Prairie	04-06	DAT05861	17,95		
KVF 750 Brute Force	05-16	DAT05858			

SUZUKI	Año	DELANTERO		TRASERO	
		Referencia	€	Referencia	€
LT-250 R Quadracer	85-92	DMX05621	20,86	DAT05853	21,20
LT-Z 250 Quadracer	04-09	DMX05621	20,86		
LT-Z 400 Quadracer	03-13	DMX05621	20,86		
LT-R 450 Quadracer	06-09	DMX05621	20,86	DAT05853	21,20
LT 500 R Quadracer	87-90	DMX05621	20,86	DAT05853	21,20
LT-A 500 Vinson	02-07			DAT05853	21,20
LT-F 500 Vinson	03-07			DAT05853	21,20

YAMAHA	Año	DELANTERO		TRASERO	
		Referencia	€	Referencia	€
YFM 125 Raptor	11-13	DAT05863	17,69	DAT05865	
YSF 200 Blaster	03-06	DAT05864	20,20		
YFM 250 Beartracker	2001	DAT05881	13,07		
YFM 250 Raptor	08-13	DAT05863	17,69	DAT05865	
YFM 350 Wolverine	95-01	DAT05881	13,07		
YFM 350 Big Bear	87-98	DAT05881	13,07		
YFM 350 Big Bear	1999	DAT05882	17,69		
YFM 350 Warrior	90-01	DAT05881	13,07	DAT05883	21,20
YFM 350 Warrior	02-04	DAT05864	20,20		
YFZ 350 Banshee	88-01	DAT05881	13,07	DAT05884	18,48
YFZ 350 Banshee	02-06	DAT05864	20,20	DAT05866	24,29
YFM 350 Raptor	05-13	DAT05864	20,20	DAT05866	24,29
YFM 400 Big Bear	00-01	DAT05881	13,07		
YFM 400 Kodiak	93-98	DAT05881	13,07		
YFM 400 Kodiak	1999	DAT05882	17,69		
YFM 400 Kodiak	00-01	DAT05881	13,07		
YFZ 450	04-06	DAT05864	20,20	DAT05865	
YFZ 450	07-13	DAT05863	17,69	DAT05865	
YFZ 450 R	09-16	DAT05863	17,69	DAT05865	
YFM 550 Grizzly	09-11	DAT05863	17,69	DAT05864	20,20
YFM 600 Grizzly	98-01	DAT05882	17,69		
YFM 660 Raptor	01-05	DAT05864	20,20	DAT05865	
YFM 700 Grizzly	07-11	DAT05864	20,20	DAT05864	20,20
YFM 700 R Raptor	07-16	DAT05863	17,69	DAT05865	

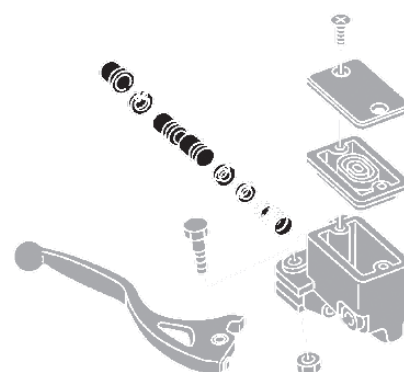

DAT05864



DAT05864

TRANSMISIÓN



XPEED Piñón, corona y cadena



	DESARROLLO ORIGEN			PIÑÓN DE ACERO			CORONA DE ACERO			CADENA ORM	
	Año	Origen	Cadena	Dientes	Referencia	€	Dientes	Referencia	€	Referencia	€
HONDA											
TRX 300 EX	93-08	13 x 38	520/86	13	L055113	9,00	38	L101138	18,00	Z53086	50,73
TRX 400 EX	99-04	15 x 38	520/92	15	RH070F15	12,00	38	L101138	18,00	Z53092	53,95
TRX 400 EX	05-08	14 x 38	520/98	14	DMX56414	12,00	38	L101138	18,00	Z53098	57,15
				15	RH080F15	12,00					
TRX 450 R	04-05	14 x 38	520/94	13	L152213	12,00	37	L101137	18,00	Z53094	55,01
				14	L152214	12,00	38	L101138	18,00		
				15	L152215	12,00	39	RH060R39	18,00		
TRX 450 R	06-08	13 x 38	520/96	13	L152213	12,00	37	L101137	18,00	Z53096	56,09
				14	L152214	12,00	38	L101138	18,00		
				15	L152215	12,00	39	RH060R39	18,00		
KAWASAKI											
				13	L160413	12,00					
KFX 400	03-06	14 x 40	520/96	14	L160414	12,00	40	L112540	18,00	Z53096	56,09
				15	DAT53715	12,00					
SUZUKI											
LT 50	84-05	11 x 37		11	L160311	9,00	37	L112637	18,00		
LT 80	87-06	10 x 22	520/36	10	L160510	9,00	22	L112422	18,00	Z53036	23,92
LT-Z 400	03-08	14 x 40	520/96	13	L160413	12,00	40	DAT033481	18,00	Z53096	56,09
				14	L160414	12,00					
				15	DAT53715	12,00					
LT-Z 400	09-12	14 x 38	520/96	13	L160413	12,00	38			Z53096	56,09
				14	L160414	12,00					
LT-R 450	06-09	14 x 36	520/96	14	RS020F14	12,00	36	RS020R36	18,00	Z53096	56,09
				15	DAT53715	12,00					
YAMAHA											
YFA 125 Breeze	91-03	12 x 32	520/74	12	L166212	9,00	32	L119932	18,00	Z53074	41,50
YFM 125 Grizzly	04-13			13	L085713	9,00					
				14	L085714	9,00					
YFS 200 Blaster	89-05	13 x 40	520/92	12	L089612	9,00	40	L120040	18,00	Z53092	53,95
				13	L089613	9,00					
				14	L089614	9,00					
YFM 350 Warrior	89-03	13 x 40	520/98	12	L166212	9,00	40	L120040	18,00	Z53098	57,15
				13	L085713	9,00					
				14	L085714	9,00					
				15	L085715	9,00					
				16	L085716	9,00					
				17	L085717	9,00					
YFM 350 R	04-13	13 x 38	520/98	12	L166212	9,00	38	DAT26538	18,00	Z53098	57,15
				13	L085713	9,00					
				14	L085714	9,00					
				15	L085715	9,00					
YFZ 350 Banshee	89-05	14 x 41	520/104	13	L085713	9,00	40	L120040	18,00	Z53104	60,38
				14	L085714	9,00					
				15	L085715	9,00					
				16	L085716	9,00					
				17	L085717	9,00					
YFZ 450	03-13	14 x 38	520/96	13	L167513	9,00	38	DAT26538	18,00	Z53096	56,09
				14	L167514	9,00					
				15	L167515	9,00					
YFM 660 R Raptor	01-05	13 x 40	520/92	12	L085412	9,00	40	L120040	18,00	Z53092	53,95
				13	L085413	9,00					
				14	L085414	9,00					
				15	L085415	9,00					
YFM 700 Raptor	06-13	14 x 38	520/98	14	DAT0304714	12,00	38	DAT26538	18,00	Z53098	57,15
				15	RY030F15	12,00					



ČZ Chains Cadenas

La cadena se sirve con enganche de clip.



Cadenas reforzadas sin retenes

Gama fabricada con recubrimiento CRK con composición de carburo para los bulones, aumentando su resistencia al desgaste. Incorporan casquillos KSJ para obtener una extensión inicial casi a cero y una larga duración.



420

Gama Reforzada sin retenes, hasta 85cc
Carga Rotura a partir de 22,000 Newtons

Referencia	Eslabones	€
Z42064	64	15,51
Z42110	110	29,22
Z42001	Remache	1,32
Z42002	Clip	1,45



428

Gama Reforzada sin retenes, hasta 150cc
Carga Rotura a partir de 23.000 Newtons

Referencia	Eslabones	€
Z43090	90	26,36
Z43100	100	28,80
Z43110	110	33,5
Z43001	Remache	1,32
Z43002	Clip	1,65



520 H

Gama Reforzada sin retenes, hasta 675cc
Carga Rotura a partir de 36,800 Newtons

Referencia	Eslabones	€
Z52036	36	17,76
Z52074	74	30,27
Z52078	78	31,58
Z52086	86	34,22
Z52090	90	35,53
Z52092	92	36,19
Z52094	94	36,85
Z52096	96	37,51
Z52098	98	38,17
Z52100	100	38,82
Z52104	104	40,14
Z52001	Remache	1,58
Z52002	Clip	2,24

Cadenas reforzadas con retenes

La cadena ORM esta fabricada con aros activos (Active-ring) con este sistema de sellado se consigue, una larga duración y una minima extensión inicial.

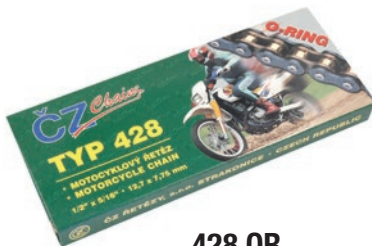

428 OR

Gama Reforzada con retenes, hasta 425cc
Carga Rotura a partir de 23,400 Newtons

Referencia	Eslabones	€
Z44090	90	36,40
Z44100	100	40,08
Z44001	Remache	1,76
Z44002	Clip	2,00



520 ORM

Gama Reforzada con retenes, hasta 700cc
Carga Rotura a partir de 34,000 Newtons

Referencia	Eslabones	€
Z53036	36	23,92
Z53074	74	41,50
Z53078	78	44,30
Z53086	86	50,73
Z53090	90	52,88
Z53092	92	53,95
Z53094	94	55,01
Z53096	96	56,09
Z53098	98	57,15
Z53100	100	58,23
Z53104	104	60,38
Z53001	Remache	2,02
Z53002	Clip	2,66



520 ATV

Gama Reforzada con retenes, hasta 600cc
Carga Rotura a partir de 34,500 Newtons

Referencia	Eslabones	€
Z56096	96	101,34
Z56098	98	103,45
Z56001	Remache	2,97
Z56002	Clip	4,45

ČZ Chains Kits de transmisión

Los kits se entregan con cadena 520 ORM



HONDA	Año	Origen	Cadena	Referencia	€
TRX 300 EX	93-08	13 x 38	520/86		
TRX 400 EX	99-04	15 x 38	520/92	L01400	82,94
TRX 400 EX	05-08	14 x 38	520/98	L01401	85,78
TRX 450 R	04-05	14 x 38	520/94	L01450	84,80
TRX 450 R	06-08	13 x 38	520/96	L01451	85,32
KAWASAKI	Año	Origen	Cadena	Referencia	€
KFX 400	03-06	14 x 40	520/112	L02400	85,34
SUZUKI	Año	Origen	Cadena	Referencia	€
LT-Z 400	03-08	14 x 40	520/96	L02400	85,34
LT-R 450	06-09	14 x 36	520/96	L02450	85,34

YAMAHA	Año	Origen	Cadena	Referencia	€
YFA 125 Breeze	91-03				
YFM 125 Grizzly	04-13	12 x 32	520/74	L03125	69,82
YFS 200 Blaster	89-05	13 x 40	520/92	L03200	76,04
YFM 350 Warrior	89-03	13 x 40	520/98	L03350	83,15
YFM 350 R	04-13	13 x 38	520/98	L03352	84,72
YFZ 350 Banshee	89-05	14 x 41	520/104	L03351	86,70
YFZ 450	03-13	14 x 38	520/96	L03450	84,30
YFM 660 R Raptor	01-05	13 x 40	520/92	L03660	83,55
YFM 700 Raptor	06-13	14 x 38	520/98	L03700	85,93

PSYCHIC Rodillos cadena

Referencia	Tipo	A	B	C	€
DMC030394	B	32	6	29	5,61
DMC030397	B	32	8	29	6,75
DMC030398	B	42	8	29	6,87
DMC030396	A	35	8	19	6,98
DMC030399	D	39	8	23	7,56
DMC0303911	C	38	8	23	8,31
DMC0303910	B	32	8	23	7,82
DMC0303912	B	32	8	23,5	8,31
DMC0303913	B	42	8	23,5	8,31

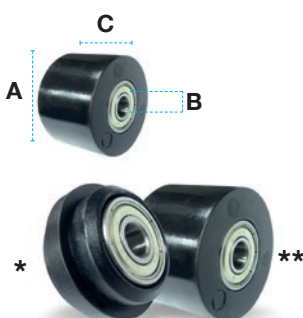

XPEED Mini cortacadenas

Referencia	€
E84-56430	23,16



XPEED Bujes completos

ARCTIC CAT	Año	Referencia	€
DVX 400	05-07	X70902	178,00
HONDA	Año	Referencia	€
TRX 400 Sportrax		X70110	129,00
TRX 450R	04-06	X70307	129,00
KAWASAKI	Año	Referencia	€
KFX 400	03-06	X70902	178,00

SUZUKI	Año	Referencia	€
LTZ 400	03-08	X70902	178,00
LTR 450		X70408	139,00
YAMAHA	Año	Referencia	€
YFZ 450	06-09	X70611	135,00
YFM 660R Raptor	01-05	X70701	155,00
YFM 700R Raptor	06-13	X70805	134,00

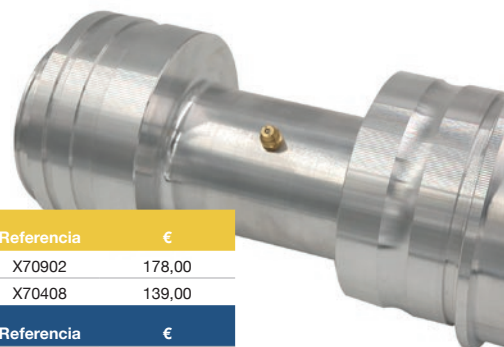

X70110
TRX 400 Sportrax



X70307
TRX 450R



X70902
LTZ 400



X70408
LTR 450



X70611
YFZ 450 06-09



X70701
YFM 660R Raptor



X70805
YFM 700R Raptor

XPEED Ejes de tracción súper reforzados

Los ejes aumentan la anchura trasera en un mínimo de 2cm y un máximo de 10cm variable, según modelo. Para el LTR 450 sólo aumenta 2 cm.
Todos los ejes están garantizados de por vida contra roturas. Los ejes para LTZ incluyen la cruceta para la corona.

€
339,37

€
387,30



2010
DAKAR
Clasificado:
3º J.M. Gonzalez
"Pedregà"

ARCTIC CAT	Año	Eje	Tuerca eje
DVX 400	05-07	R732002	R733002
HONDA	Año	Eje	Tuerca eje
TRX 450R	04-06	R732007	
KAWASAKI	Año	Eje	Tuerca eje
KFX 400	03-06	R732002	R733002
KYMCO	Año	Eje	Tuerca eje
KXR 250		R732004	R733006

SUZUKI	Año	Eje	Tuerca eje
LTZ 400	03-08	R732002	R733002
LTR 450		R732008	R733002
YAMAHA	Año	Eje	Tuerca eje
YFS 200 Blaster	88-06	R732009	R733001
YFZ 350 Banshee	88-08	R732009	R733001
YFM 350 Raptor	05-09	R732003	R733001
YFZ 450	04-08	R732006	R733006
YFM 660R Raptor	01-05	R732001	R733001
YFM 700R Raptor	06-10	R732005	R733006

€
35



XPEED Tuerca central eje

€
98

XPEED Cruceta de sujeción corona

HONDA	Año	Referencia
TRX 450 R	04-06	R732107
YAMAHA	Año	Referencia
YFM 700 Raptor	06-15	R732105



Referencia	Descripción	€
R730001	Kit 2 tuercas para eje Xpeed	8,42



Referencia	Descripción	€
R730005	Kit casquillos para eje Xpeed	7,60





Correas variador ATV

La tecnología ULTIMAX alarga la vida a las correas y transmite mejor la potencia.



ARGO	Año	Ref. Original	Ref. Impnesa	€
Avenger 8X8	05-12	127-137	UA428	60,06

ARCTIC CAT	Año	Ref. Original	Ref. Impnesa	€
360	08-11	0823-228	UA450	96,36
400	03-08	3402-664	UA400	90,09
400 TRV	13-14	0823-228	UA459	
425	2012	0823-228	UA450	96,36
450	11-12	0823-228	UA450	96,36
500	03-09	3402-757	UA401	90,09
500 TRV	13-14	0823-228	UA459	
500 Prowler	2014	0823-228	UA459	
550 HI	09-12	0823-013	UA406	105,11
550 TRV	09-14	0823-013	UA406	105,11
550 Prowler	09-14	0823-013	UA406	105,11
650 V-TWIN	04-06	3201-242	UA450	96,36
650 HI	05-12	0823-013	UA406	105,11
650 Prowler	06-10	0823-013	UA406	105,11
700	2008	3403-141	UA401	90,09
700	09-14	0823-013	UA406	105,11
700 Prowler	08-14	0823-013	UA406	105,11
1000 TRV H2 EFI Cruiser	09-11	0823-231	UA445	121,49
1000 Thundercat	09-12	0823-231	UA445	121,49
1000 Prowler XTZ	09-14	0823-231	UA445	121,49
1000 Wild Cat	2013	0823-231	UA445	121,49
1000 Wild Cat	2014	0823-391	UA461	

CAN AM	Año	Ref. Original	Ref. Impnesa	€
Outlander 400	03-14	715-900-024	UA435	90,09
Renegade 500	2008	715-900-030	UA419	105,11
Renegade 500	09-14	715-000-302	UA446	122,85
Outlander 500	07-08	715-900-030	UA419	105,11
Outlander 500	09-14	715-000-302	UA446	122,85
Outlander 650	06-08	715-900-030	UA419	105,11
Outlander 650	09-14	715-000-302	UA446	122,85
Commander 800	11-14	715-000-302	UA446	122,85
Renegade 800	2008	715-900-030	UA419	105,11
Renegade 800	09-14	715-000-302	UA446	122,85
Outlander 800	06-08	715-900-030	UA419	105,11
Outlander 800	09-14	715-000-302	UA446	122,85
Commander 1000	2011	715-000-302	UA446	122,85
Maverik 1000	2014	715-000-302	UA446	122,85
Renegade 1000	12-14	715-000-302	UA446	122,85
Outlander 1000	12-14	715-000-302	UA446	122,85

KAWASAKI	Año	Ref. Original	Ref. Impnesa	€
Brute Force 300	12-14	59011-Y003	UA452	101,05
Praire 360	03-04	59011-1084	UA407	105,11
Praire 360	05-13	59011-0003	UA450	96,36
Praire 650	02-03	59011-0003	UA450	96,36
Brute Force 650	05-13	59011-0003	UA450	96,36
Brute Force 650i	08-13	59011-0003	UA450	96,36
KFX 700 V Force	04-10	59011-0003	UA450	96,36
Brute Force 750	05-12	59011-0003	UA450	96,36
Brute Force 750i	07-14	59011-0003	UA450	96,36
Teryx 750	08-14	59011-0019	UA450	96,36
Teryx 750 "4"	12-14	59011-0033	UA458	

POLARIS	Año	Ref. Original	Ref. Impnesa	€
Phoenix 200	05-14	0452496	UA453	77,09
Trail Blazer 250	00-06	3211077	UA412	75,08
Hawkeye 300	2009	3211131	UA440	73,74
Sportsman 300	2009	321131	UA440	73,74
Trail Blazer 330	08-13	3211077	UA412	75,08
Trail Boss 330	03-13	3211077	UA412	75,08
Magnum 330 2X4,4X4	03-06	3211077	UA412	75,08
Sportsman 400	2009	3211131	UA440	73,74
Sportsman 400 HO	12-14	3211077	UA412	75,08
Scrambler 400	00-02	3211069	UA413	75,08

Scrambler 500	00-13	3211077	UA412	75,08
Hawkeye	06-07	3211108	UA427	75,08
ATP 500 H.O.	04-05	3211069	UA413	75,08
Sportsman 6x6	00-07	3211077	UA412	75,08
Sportsman 500 HO	2001	3211077	UA412	75,08
Sportsman 500 HO	03-04	3211069	UA413	75,08
Sportsman 500 HO	2005	3211095	UA413	75,08
Sportsman 500 EFI	2006	3211091	UA413	75,08
Sportsman 500 HO	06-12	3211077	UA412	75,08
Sportsman 500 EFI	07-12	3211113	UA426	90,09
Sportsman 550 XP EFI	09-14	3211123	UA448	122,85
Sportsman 570	2014	3211113	UA426	90,09
Sportsman 600 Twin	03-05	3211091	UA413	75,08
Sportsman 700	02-06	3211091	UA413	75,08
Sportsman 700	07	3211116	UA426	90,09
Sportsman 800 Twin EFI	05-06	3211106	UA424	105,11
Sportsman 800	07-14	3211113	UA426	90,09
Scrambler 850	13-14	3211123/30/60	UA448	122,85
Sportsman 850 XP EFI	09-14	3211123	UA448	122,85
Ranger 500	06-09	3211077	UA412	75,08
Ranger 700	06-09	3211118	UA424	105,11
Ranger 800	10-14	3211118	UA424	105,11
Ranger 900	2014	3211142/8	UA441	137,37
RZR 800	08-14	3211113	UA426	90,09
RZR 4 800	11-14	3211133	UA424	105,11
RZR 800 "S"	10-14	3211133	UA424	105,11
RZR 800 XP	2012	3211136	UA456	137,47
RZR 900 XP	11-14	3211142/8	UA441	137,47
RZR 900 XP "4"	12-14	3211142/8	UA441	137,47
RZR 1000 XP	2014	3211142/8	UA441	137,47
RZR 1000 XP "4"	2014	3211142/8	UA441	137,47

SUZUKI	Año	Ref. Original	Ref. Impnesa	€
LTF 400 Eiger	02-07	27601-38F00	UA400	90,09
LTA 400 King Quad	08-13	27601-38F00	UA400	90,09
LTA 450 King Quad	07-13	27601-11H00	UA443	111,93
LTA 500 Vinson	02-07	27601-09F60	UA401	90,09
LTA 500 King Quad	09-13	27601-11H00	UA443	111,93
LTV 700 Twin Peaks	04-05	K5901-10003	UA450	96,36
LTA 700 King Quad	05-07	27601-31G00	UA437	105,11
LTA 750 King Quad	08-13	27601-31G00	UA437	105,11

YAMAHA	Año	Ref. Original	Ref. Impnesa	€
YFM 125 Breeze	89-04	3FA-17641-00	UA425	105,11
YFM 125 Grizzly	04-13	3FA-17641-00	UA425	105,11
YFM 300 Grizzly	12-13	1SC-E7641-00	UA452	101,05
YFM 350 Bruin	04-06	5UH-17641-00	UA416	105,11
YFM 350 Grizzly	07-15	5UH-17641-00	UA416	105,11
YFM 350 Wolverine	05-08	5UH-17641-00	UA416	105,11
YFM 400 Kodiak	00-06	5GH-17641-00	UA417	90,09
YFM 400 Grizzly	07-14	5GH-17641-00	UA417	90,09
YFM 450 Wolverine	05-09	5GH-17641-00	UA417	90,09
YFM 450 Grizzly	07-15	5GH-17641-00	UA417	90,09
YFM 450 Kodiak	01-06	5GH-17641-00	UA417	90,09
YXR 450 Rhino	06-08	5GH-17641-00	UA417	90,09
YFM 550 Grizzly	11-15	28P-17641-00	UA422	105,11
YFM 600 Grizzly	98-01	4WV-17641-00	UA423	105,11
YFM 660 Grizzly	02-08	5KM-17641-00	UA422	105,11
YFM 700 Grizzly	07-15	3B4-17641-00	UA422	105,11
YXR 660 Rhino	05-08	5KM-17641-00	UA422	105,11
YXR 700 Rhino	08-13	5B4-17641-00	UA438	105,11
YXR 700 Viking	14-15	1XD-17641-00	UA464	132,15
YXR 700 Viking VI	14-15	1XD-17641-00	UA464	132,15

BRONCO Rodillos variador

SUZUKI	Año	Descripción	Referencia
LT-A 450 King Quad	08-10	8 rodillos 30mm x 18mm 25g.	DAT034201
LT-A 500 King Quad	11-13	8 rodillos 30mm x 18mm 25g.	DAT034201
LT-A 500 Quad Master	00-01	8 rodillos 30mm x 18mm 25g.	DAT034201
LT-A 500 Vinson	02-07	8 rodillos 30mm x 18mm 25g.	DAT034201
LT-A 700 King Quad	05-07	8 rodillos 30mm x 18mm 28g.	DAT034202
LT-A 750 King Quad	08-15	8 rodillos 30mm x 18mm 28g.	DAT034202

YAMAHA	Año	Descripción	Referencia
YFM 350 Bruin	04-06	8 rodillos 30mm x 15mm 21g.	DAT034103
YFM 350 Grizzly	07-14	8 rodillos 30mm x 15mm 21g.	DAT034103
YFM 350 Wolverine	06-09	8 rodillos 30mm x 15mm 21g.	DAT034103
YFM 400 Kodiak	07-08	8 rodillos 30mm x 15mm 15g.	DAT034102
YFM 400 Kodiak	00-06	8 rodillos 30mm x 15mm 15g.	DAT034102
YFM 450 Grizzly	07-14	8 rodillos 30mm x 15mm 15g.	DAT034102
YFM 450 Kodiak	03-06	8 rodillos 30mm x 15mm 15g.	DAT034102
YFM 450 Wolverine	06-11	8 rodillos 30mm x 15mm 15g.	DAT034102
YXR 450 Rhino	06-09	8 rodillos 30mm x 15mm 15g.	DAT034102
YFM 550 Grizzly	09-14	8 rodillos 30mm x 15mm 21g.	DAT034103
YFM 600 Grizzly	98-01	8 rodillos 30mm x 15mm 21g.	DAT034103
YFM 660 Grizzly	02-08	8 rodillos 30mm x 15mm 18g.	DAT034101
YXR 660 Rhino	03-07	8 rodillos 30mm x 15mm 18g.	DAT034101
YFM 700 Grizzly	07-14	8 rodillos 30mm x 15mm 21g.	DAT03410
YXE 700 Wolverine	2016	8 rodillos 30mm x 15mm 21g.	DAT03410
YXM 700 Viking	14-16	8 rodillos 30mm x 15mm 21g.	DAT03410
YXR 700 Rhino	08-13	8 rodillos 30mm x 15mm 20g.	DAT034104

€
24,95



RUEDAS Y NEUMÁTICOS

MOTOR

ADMISIÓN / ESCAPE
REFRIGERACIÓN

ELÉCTRICO

SUSPENSIÓN / DIRECCIÓN

FRENOS

TRANSMISIÓN

CONTROLES Y MANDOS

CHASIS

ACCESORIOS

BRONCO

Pastillas de variador Polaris

Referencia: DAT03129 € 26,00 (10 unidades)
Ref. Original: 5431936, 5439254
Descripción: exterior Ø13,91/14,1 mm, ancho 6,3 mm

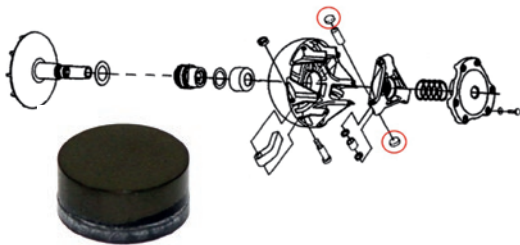

BRONCO

Casquillo variador

Referencia: DAT03128 € 5,28
Ref. Original: 5020795
Descripción: exterior Ø9,5 mm, interior Ø6,5 mm, ancho 25,4 mm

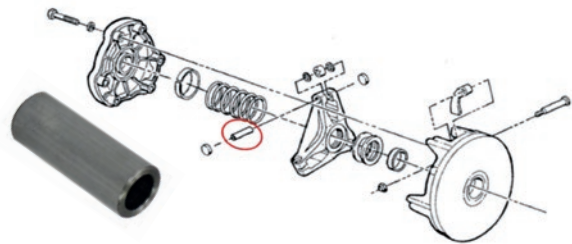

BRONCO Rodillos embrague

Referencia: DAT03130 € 5,32
Ref. Original: 1321977
Descripción: exterior Ø19,6/21,5 mm, interior Ø6,8 mm, ancho 19,15 mm



Referencia: DSM03106 € 31,36 (2 unidades)
Ref. Original: 3234197 / 3234207 / 5434534
Descripción: exterior Ø23,7 mm, interior Ø9,6 mm, ancho 14 mm

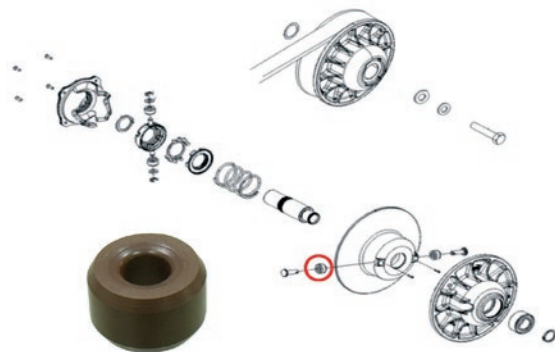

BRONCO Casquillos embrague Polaris

Referencia: DAT03125 € 16,48
 Ref. Original: 3585712
 Descripción: exterior Ø62 mm, interior Ø57,4 mm, ancho 25,5 mm

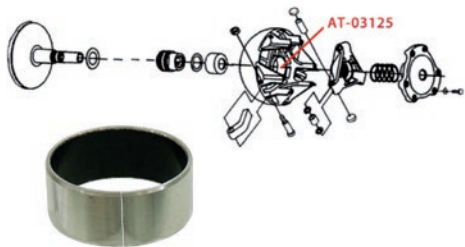

Referencia: DAT03131 € 13,65
 Ref. Original: 3585710
 Descripción: exterior Ø58,8 mm, interior Ø54,4 mm, ancho 12,5 mm

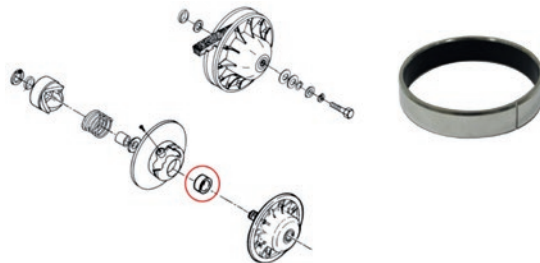

Referencia: DAT03145 € 16,00
 Ref. Original: 3514492
 Descripción: exterior Ø49,2 mm, interior Ø44,4 mm, ancho 25,4 mm

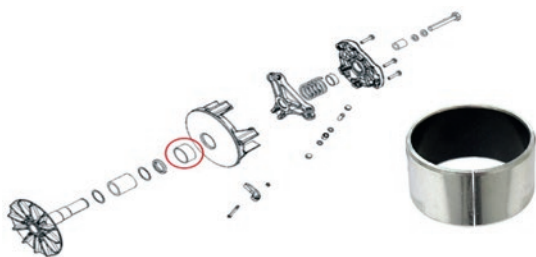

Referencia: DAT03148 € 8,85
 Ref. Original: 3514684
 Descripción: exterior Ø32,7 mm, interior Ø28,7 mm, ancho 19,1 mm

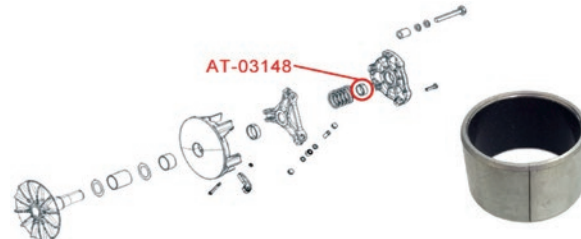

Referencia: DAT03149 €
 Ref. Original: 5437682
 Descripción: exterior Ø19,5 mm, interior Ø12,2 mm, ancho 12,7 mm

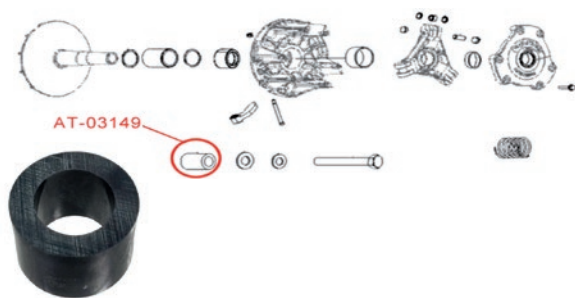

Referencia: DSM03101 € 13,65
 Ref. Original: 3576504
 Descripción: exterior Ø42,1 mm, interior Ø38,2 mm, ancho 12,7 mm

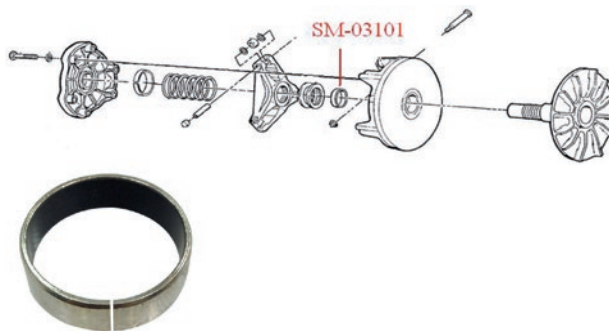

Referencia: DSM03045A € 13,65
 Ref. Original: 3576511
 Descripción: exterior Ø42 mm, interior Ø38,2 mm, ancho 25,3 mm

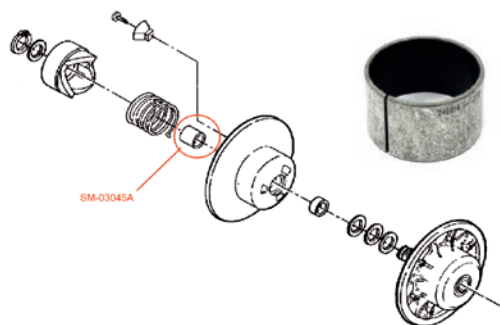

BRONCO

Kit reparación variador Polaris



DAT03418
Rodillos de
14mm de ancho



DAT03419
Rodillos de
9mm de ancho

Referencia	Descripción	€
DAT03418	Rodillos de 14 mm de ancho	44,12
DAT03419	Rodillos de 9 mm de ancho	38,93

BRONCO

Guía rampa embrague Polaris

Referencia	Unidades	€
D03151040	3	6,00
D03151040T	12	18,00



BRONCO

Perno embrague arrancador

Referencia: DAT12670 € 19,23€
Ref. Original: 38030023
Descripción: M19 x 18G 3/8", largo 159mm



POLARIS	Año
550 Sportsman	09-15
800 RZR	08-14
850 Scrambler	13-15
850 Sportsman	09-15

€
16,48

BRONCO

Kit reparación variador

Referencia: DAT03425
Ref. Original: 417-2232-57 / 417-2232-69 / 417-2233-87 / 417-2237-67 / 420-2812-90 / 420-2812-91 / 420-2812-93 / 420-6262-31 /

CAN AM	Año
Outlander 400	06-14
Outlander 500	07-14
Renegade 500	08-14
Outlander 650	06-14
Commander 800	12-14
Outlander 800	06-14
Renegade 800	07-14
Commander 1000	12-14
Maverick 1000	13-14



BRONCO

Kit contrapesos variador

€
67



DAT03134
Serie 10MHF



DAT03415
Serie 10WHF



DAT03416
Serie 10BH



DAT03417
Serie 25-52

POLARIS	Año	Referencia	Peso	Original
400 Hawkeye	2012	DAT03415	45G(+/-0.2G)	5632283
400 Ranger	10-13	DAT03416	45G(+/-0.2G)	5632401
400 Sportsman	11-13	DAT03415	45G(+/-0.2G)	5632283
450 Sportsman	06-07	DAT03415	45G(+/-0.2G)	5632283
500 Ranger	08-09	DAT03134	50G(+/-0.2G)	5632281
500 Ranger	10-13	DAT03417	52G(+/-0.2G)	5632409
500 Scrambler	98-08	DAT03415	45G(+/-0.2G)	5632283
500 Scrambler	10-12	DAT03417	52G(+/-0.2G)	5632409
500 Sportsman	01-13	DAT03415	45G(+/-0.2G)	5632283
500 Worker	2001	DAT03415	45G(+/-0.2G)	5632283
570 RZR	12-13	DAT03417	52G(+/-0.2G)	5632409

RUEDAS Y NEUMÁTICOS

MOTOR

ADMISIÓN / ESCAPE
REFRIGERACIÓN

ELECTRICO

SUSPENSIÓN / DIRECCIÓN

FRENOS

TRANSMISIÓN

CONTROLES Y MANDOS

CHASIS

ACCESORIOS



J.COSTA Recambios variadores J.Costa

Recomendamos un mantenimiento cada 8.000km para los vehículos que tengan una utilización normal. Se debe verificar estado de masas y casquillo. Es conveniente verificar la holgura del casquillo, la no sustitución del casquillo con holgura ocasionará un desgaste muy prematuro a todos los componentes.



		MASAS		CASQUILLO		BULON		CAMPANA	
	Año	Referencia	€	Referencia	€	Referencia	€	Referencia	€
AXR									
Crossbone 400		JCD20014M	30,00	JC383038	20,00	JC625S		JC803C	30,00
CFMOTO									
Buggy 500		JCJ23516M	35,00	JC453547	35,00	ORIGEN		JC806C	30,00
KYMCO									
Mxer 150		JCA08512M	25,00	JC332525WRS	14,00	JC611S	12,50	JC611C	30,00
Maxxer 250		JCD12514M	30,00	JC383038	20,00	JC701S	15,00	JC701C	30,00
Mongoos 250		JCD12514M	30,00	JC383038	20,00	JC701S	15,00	JC701C	30,00
MXU 250		JCD12514M	30,00	JC383038	20,00	JC701S	15,00	JC701C	30,00
MXU 300		JCD13514M	30,00	JC383038	20,00	JC701S	15,00	JC701C	30,00
MXU 500		JCJ21016M	35,00	JC504255	50,00	ORIGEN		JC705C	36,00
PGO									
Buggy 250									
Buggy 500		JCD20014M	30,00	JC383038	20,00	JC625S		JC625C	30,00
XILING									
Buggy 250		JCD10514M	30,00	JC383038	20,00	JC613S	15,00	JC801C	30,00
YAMAHA									
YFM 660 Grizzly	02-08	JCJ21016M	35,00	JC453555		ORIGEN		JC714C	36,00
YXR 660 Rhino	04-07	JCJ21016M	35,00	JC453555		ORIGEN		JC714C	36,00
YFM 700 Grizzly	07-15	JCJ22016M	35,00	JC453555		ORIGEN		JC714C	36,00
YXR 700 Rhino	08-13	JCJ22016M	35,00	JC453555		ORIGEN		JC714C	36,00

J.COSTA Variadores J.Costa

Los variadores J.Costa ofrecen mayores prestaciones y suavidad en conducción, mejorando la recuperación y ofreciendo un mayor tacto en la desaceleración.

El modelo Urban mejora prestaciones. El modelo Urban EVO 3 mejora prestaciones y consumos.

Es esencial montar los variadores utilizando una llave dinamométrica para su correcta instalación, con el par de apriete recomendado por el fabricante (**un par de apriete distinto al recomendado ocasionará graves daños en el embrague y en el cigüeñal**)



	URBAN			URBAN EVO 3		
AXR	Año	Referencia	€	Referencia	€	Par de apriete
Crossbone 400		JC803B	250,00			10,5 Kg.
CFMOTO	Año	Referencia	€	Referencia	€	Par de apriete
Buggy 500		JC806B	375,00			16 Kg.
KYMCO	Año	Referencia	€	Referencia	€	Par de apriete
Mxer 150		JC702Q	200,00			9,3 Kg.
Maxxer 250				JC701Q	200,00	10 Kg.
Mongoos 250				JC701Q	200,00	10 Kg.
MXU 250				JC701Q	200,00	10 Kg.
MXU 300		JC703Q	200,00			10 Kg.
MXU 500		JC705Q	375,00			13,8 Kg.
PGO	Año	Referencia	€	Referencia	€	Par de apriete
Buggy 250				JC804B	200,00	9,3 Kg.
Buggy 500				JC805B	250,00	16 Kg.
XILING	Año	Referencia	€	Referencia	€	Par de apriete
Buggy 250		JC801B	250,00			8 Kg.
YAMAHA	Año	Referencia	€	Referencia	€	Par de apriete
YFM 660 Grizzly	02-08	JC713Q	375,00			16 Kg.
YXR 660 Rhino	04-07	JC713Q	375,00			16 Kg.
YFM 700 Grizzly	07-15	JC714Q	375,00			16 Kg.
YXR 700 Rhino	08-13	JC714Q	375,00			16 Kg.



Variador original

Los rodillos son empujados al exterior del variador, a consecuencia de la inercia en la aceleración, y caen a plomo en la desaceleración.

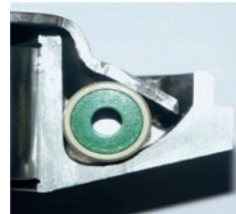

Original cerrado

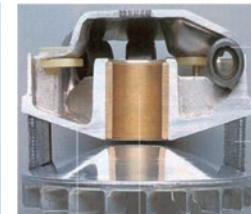

Original abierto

Variador J. Costa

Las masas son empujadas al exterior del variador, a consecuencia de la inercia en la aceleración, pero se repliegan paulatinamente en la desaceleración, consecuentemente al acelerar entre regímenes la recuperación es mucho más rápida.

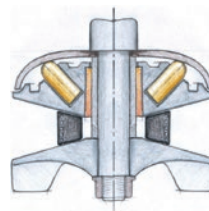

J.Costa cerrado

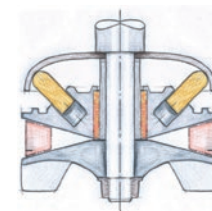

J.Costa abierto

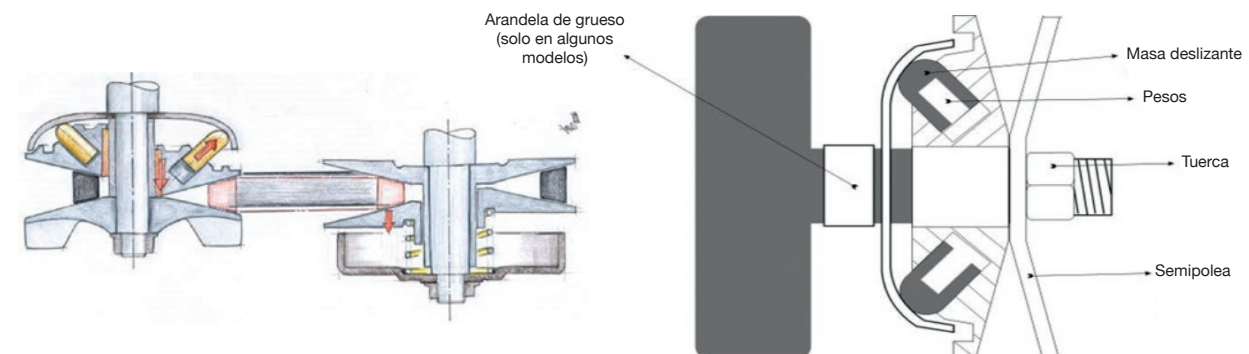

RUEDAS Y NEUMÁTICOS

MOTOR

ADMISIÓN / ESCAPE
REFRIGERACIÓN

ELÉCTRICO

SUSPENSIÓN / DIRECCIÓN

FRENOS

TRANSMISIÓN

CONTROLES Y MANDOS

CHASIS

ACCESORIOS

BRONCO Crucetas cardan

€
22

ARCTIC CAT	Año	Posición	Referencia	Posición	Referencia
250	01-05	4	DAT08514		
300	98-05	4	DAT08514		
375	2002	4	DAT08514		
400	2002	4	DAT08514		
400	2001	3 4	DAT08514		
400	98-00	4	DAT08514		
400	03-04	4	DAT08515		
400 FIS	2002	4	DAT08514		
400 FIS	03-08	4	DAT08515		
400 TBX	04-06	4	DAT08515		
400 TRV	07-13	4	DAT08515		
400 VP	05-06	3 4	DAT08515		
450 EFI	2012	4	DAT08515		
450 H1	10-11	4	DAT08515		
400 TRV	2012	4	DAT08515		
454 4x4	96-98	4	DAT08514		
500	98-99	4	DAT08514		
500	00-02	3 4	DAT08514		
500 EFI	2013	3	DAT08515		
500 FIS	2002	3	DAT08514		
500 FIS	03-09	3	DAT08515		
500 TBX FIS	2002	3 6	DAT08514		
500 TBX FIS	03-06	3	DAT08514		
500 TRV FIS	03-08	3	DAT08515		
500 TRV	2013	3	DAT08515		
500 XT	2013	3	DAT08515		
550 EFI	12-13	3	DAT08515		
550 GT	2012	3	DAT08515		
550 FIS	09-11	3	DAT08515		
550 TRV	09-11	3	DAT08515		
550 TRV	2012	3	DAT08515		
550 TRV	2013	3	DAT08515		
550 XT	2013	3	DAT08515		
650 H1	05-11	4	DAT08515		
650 Mud Pro	10-11	4	DAT08515		
650 Prowler XT	2006	3 4	DAT08515	5 6	DAT08509
650 Prowler XT	07-09	5 6	DAT08509	6	
650 V2	04-06	3 4	DAT08515	5 6	DAT08509
700 Diesel	08-13	4	DAT08515		
700 EFI Auto	07-08	3 4	DAT08515		
700 EFI	09-12	3	DAT08515		
700 GT	2012	4	DAT08515		
700 H1	08-11	4	DAT08515		
700 LTD	2013	3	DAT08515		
700 Mud Pro	09-11	4	DAT08515		
700 Mud Pro	12-13	3	DAT08515		
700 TRV	2008	3 4	DAT08515		
700 TRV	09-11	3	DAT08515		
700 TRV	2012	3	DAT08515		
700 XT	2013	3 4 5 6	DAT08515		
1000 Cruiser	2012	3 4 5 6	DAT08514		
1000 GT	2012	3 4 5 6	DAT08514		
1000 Thunder Cat	2008	3 4	DAT08515		
1000 Thunder Cat	09-11	3 4 5 6	DAT08514		
1000 Mud Pro	10-13	3 4 5 6	DAT08514		
1000 TRV	12-13	3 4 5 6	DAT08514		
1000 Prowler	2009	3 4 5 6	DAT08514		
1000 Prowler	10-13	3 4	DAT08514		

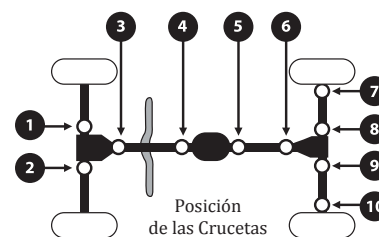

CAN AM	Año	Posición	Referencia	Posición	Referencia
330 Outlander	04-05	5 6	DAT08532		
400 Outlander	03-15	5 6	DAT08532		
500 Outlander	07-15	4	DAT08532	5 6	DAT08533
500 Quest	02-03	3 4 5	DAT08532		
500 Quest	2004	5	DAT08532		
500 Renegade	08-12	4	DAT08532	5 6	DAT08533
500 Renegade	13-15	5 6	DAT08533		

500 Traxter	99-04	3 4 5	DAT08532		
650 Outlander	06-12	4	DAT08532	5 6	DAT08533
650 Outlander	13-15	5 6	DAT08533		
650 Quest	02-03	3 4	DAT08532	5	DAT08533
650 Quest	2004	5	DAT08533		
800 Commander	11-13	3 4	DAT08532	5 6	DAT08533
800 Commander	14-15	5 6	DAT08533		
800 Outlander	06-11	4	DAT08532	5 6	DAT08533
800 Outlander	12-15	5 6	DAT08533		
800 Renegade	07-11	4	DAT08532	5 6	DAT08533
800 Renegade	12-15	5 6	DAT08533		
1000 Commander	11-14	3 4	DAT08532	5 6	DAT08533
1000 Commander	2015	5 6	DAT08533		
1000 Outlander	12-15	5 6	DAT08533		
1000 Renegade	12-15	5 6	DAT08533		
1000 Maverick	13-15	3 4	DAT08532	5	DAT08533

KAWASAKI	Año	Posición	Referencia	Posición	Referencia
KLF 300 Bayou	89-04	3 4	DAT08531		
KVF 300 Prairie 2x4	99-02	6	DAT08513		
KVF 300 Prairie 4x4	99-02	3 4	DAT08535		
KVF 300 Prairie 4x4	03-09	5	DAT08513		
KVF 360 Prairie 2x4	03-09	6	DAT08534		
KVF 360 Prairie 4x4	03-13	5	DAT08534		
KLF 400 Bayou 4x4	93-99	3 4	DAT08535		
KVF 400 Prairie 2x4	98-02	6	DAT08513		
KVF 400 Prairie 4x4	97-02	3 4	DAT08535	5	DAT08513
KVF 650 Prairie	02-03	5	DAT08534		
KVF 650 Brute Force	05-13	5	DAT08534		
KVF 650 i Brute Force	06-13	5 6	DAT08534		
KFX 700 V-Force	04-09	6	DAT08534		
KVF 700 Prairie	04-06	5	DAT08534		
KVF 750i Brute Force	05-15	5 6	DAT08534		
KRT 750 Teryx	08-13	3 4	DAT08513	5 6	DAT08539
610 Mule 4x4 (400cc)	05-13	3 4 5 6	DAT08513		
620 Mule (todos)	94-09	7 8 9 10	DAT08514		
2510 Mule (620cc)	00-02	5 6 6	DAT08513	7 8 9 10	DAT08514
2510 Mule (950cc) diesel	00-02	5 6 6	DAT08513	7 8 9 10	DAT08514
2520 Mule (620cc)	93-09	7 8 9 10	DAT08514		
3000 Mule (620cc)	01-08	7 8 9 10	DAT08514		
3010 Mule (620cc)	01-08	5 6 6	DAT08513	7 8 9 10	DAT08539
3010 Mule (950cc) diesel	01-08	5 6 6	DAT08513	7 8 9 10	DAT08539
3020 Mule (620cc)	01-03	7 8 9 10	DAT08514		
4000 Mule (620cc)	09-15	7 8 9 10	DAT08514		
4010 Mule (620cc)	09-15	5 6 6	DAT08513	7 8 9 10	DAT08539
4010 Mule (950cc) diesel	09-15	5 6 6	DAT08513	7 8 9 10	DAT08539

SUZUKI	Año	Posición	Referencia	Posición	Referencia	Posición	Referencia
LT-A 250 Ozark	02-06	5	DAT08515				
LT-F 250 Quad Runner 2x4	88-94	5 6	DAT08509	7 10	DAT08537	8 9	DAT08536
LT-F 250 Quad Runner 4x4	88-93	3 4 5 6	DAT08509	7 10	DAT08537	8 9	DAT08536
LT-F 250 Quad Runner 4x4	88-93	5	DAT08514				
LT-F 250 Quad Runner 4x4	94-00	5	DAT08514	7 10	DAT08537	3 4	DAT08509
LT-F 250 Quad Runner 2x4	2001	3 4	DAT08518	7 10	DAT08537	8 9	DAT08536
LT-F 250 Quad Runner 2x4	2002	3 4	DAT08518				
LT-F 250 Quad Runner 4x4	01-02	5	DAT08515	7 10	DAT08537		
LT-Z 250 Quad Sport	04-06	5	DAT08515				
LT-F 300 Quad Runner 4x4	1994	5	DAT08514	7 10	DAT08538	8 9	DAT08536
LT-F 300 Quad Runner 4x4	1995	5	DAT08514	7 10	DAT08538		
LT-F 300 King Quad 4x4	91-93	8 9	DAT08536	7 10	DAT08538		
LT-F 300 King Quad 4x4	96-98	5	DAT08514	7 10	DAT08538		
LT-F 300 King Quad 4x4	99-00	3 4	DAT08518	7 10	DAT08538	5	DAT08514
LT-F 300 King Quad 4x4	01-02	3 4	DAT08518	7 10	DAT08538	5	DAT08515
LT-A 400 Eiger	02-07	3 5 6	DAT08515				
LT-A 450 King Quad	08-10	3 4	DAT08515				
LT-A 500 King Quad	09-14	3 4	DAT08518				
LT-A 500 Quad Master 4x4	2000	3 5	DAT08514				
LT-A 500 Quad Master 4x4	2001	5 6	DAT08514	3	DAT08515		
LT-A 500 Quad Runner 4x2	98-00	5	DAT08514				
LT-A 500 Quad Runner 4x2	2001	5 6	DAT08515				
LT-A 500 Quad Runner 4x2	2002	3 5 6	DAT08515				

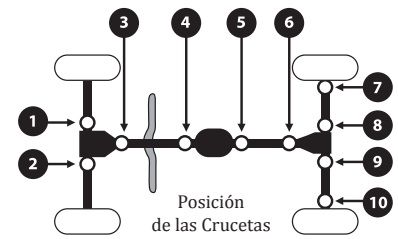

Referencia	A (mm)	B (mm)
DAT08500	20	58,70
DAT08501	25,4	82
DAT08502	27	65,50
DAT08503	23,9	59,50
DAT08507	22	55,60
DAT08509	25	66
DAT08513	22	53,20
DAT08514	25	63,30
DAT08515	20	56,40
DAT08516	20	37
DAT08518	25	65
DAT08532	22	55,35
DAT08533	25	64,70
DAT08534	24	58
DAT08535	20	50,60
DAT08536	32,9	56,60
DAT08537	20	51
DAT08538	31	51
DAT08539		
DAT08573		

BRONCO Crucetas cardan

€
22

LT-A 500 Quad Runner 4x4	98-02	3 4	DAT08518	5	DAT08509
LT-A 550 King Quad	2012	3 4	DAT08518		
LT-A 700 King Quad	05-07	3 4	DAT08518	6	DAT08509
LT-A 750 King Quad	08-14	3 4	DAT08518		

YAMAHA	Año	Posición	Referencia	Posición	Referencia
YFM 250 Bear Tracker	99-04	5	DAT08509		
YFM 250 Big Bear	07-08	5	DAT08500		
YFM 250 Bruin	2006	5	DAT08500		
YFM 250 Timberwolf 2x4	92-98	5	DAT08509		
YFM 250 Timberwolf 4x4	94-00	3 4	DAT08516	5 6	DAT08509
YFM 350 Big Bear	87-99	3 4	DAT08516	5 6	DAT08509
YFM 350 Grizzly	07-08	5	DAT08500		
YFM 350 Grizzly IRS	07-13	3 4 5 6	DAT08500		
YFM 350 Wolverine	06-08	5	DAT08500		
YFM 350 Wolverine	95-98	3 4	DAT08500	5 6	DAT08509
YFM 400 Big Bear	2006	3 4	DAT08500		
YFM 400 Big Bear	07-12	3 4 5 6	DAT08500		
YFM 400 Grizzly	07-08	3 4 5 6	DAT08500		
YFM 400 Kodiak	93-97	3 4	DAT08516	5 6	DAT08509
YFM 400 Kodiak	98-99	3 4	DAT08500		
YFM 400 Kodiak	05-06	5 6	DAT08500		
YFM 450 Grizzly	09-13	3 4 5 6	DAT08500		
YFM 450 Kodiak	03-06	3 4 5 6	DAT08500		
YXR 450 Rhino	2006	3 4	DAT08500		
YFM 450 Wolverine	07-08	5	DAT08500		
YFM 600 Grizzly	1998	3 4	DAT08516	5 6	DAT08509
YXR 660 Rhino	04-07	3 4	DAT08500		
YXR 700 Rhino	08-13	3 4	DAT08500		

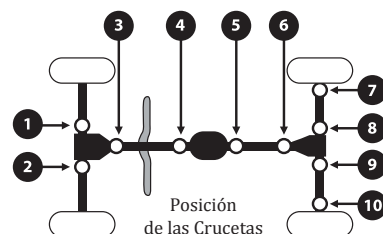

POLARIS	Año	Posición	Referencia	Posición	Referencia	Posición	Referencia	Posición	Referencia
250 4x4	90-93	1 2	DAT08503						
250 Trail Boss	87-92	1 2	DAT08503						
250 Xplorer	00-02	1 2 3 4	DAT08503						
300	1994	1 2	DAT08503						
300	1995	1 2	DAT08507						
300	1996	1 2	DAT08503						
300 Hawkeye	06-07	3 4	DAT08503						
300 Sportsman	08-10	3 4	DAT08503						
300 Xplorer	96-99	1 2	DAT08507						
325 Magnum 2x4	00-02	5	DAT08503						
325 Magnum 4x4	00-02	1 2	DAT08507	3 4 5	DAT08503				
325 Sportsman ACE	14-15	3 4	DAT08495						
325 Xpedition 4x4	00-02	1 2	DAT08507	3 4 5	DAT08503				
330 ATP 4x4	04-05	1 2 3 4	DAT08503	5	DAT08507				
330 Magnum HDS	03-04	5	DAT08507	3 4	DAT08503				
330 Magnum	03-06	5	DAT08507	3 4	DAT08503				
335 Sportsman	99-00	1 2	DAT08507	3 4	DAT08503	8 9	DAT08501	7 10	DAT08502
335 Sportsman ACE	14-15	3 4	DAT08495						
335 Worker	1999	1 2	DAT08507	3 4	DAT08503	8 9	DAT08501	7 10	DAT08502
350L Trail Boss	90-93	1 2	DAT08503						
400 4x4	1994	1 2	DAT08503						
400 Scrambler	95-97	1 2 int.	DAT08503	1 2 ext.	DAT08507				
400 Scrambler	98-02	1 2 int.	DAT08503	1 2 ext.	DAT08507	3 4	DAT08503		
400 Sportsman	93-94	1 2	DAT08503						
400 Sportsman	95-96	1 2 int.	DAT08503	1 2 ext.	DAT08507				
400 Sportsman	1997	1 2	DAT08507						
400 Sportsman	2001	3 4	DAT08503						
400 Sportsman	02-04	1 2 3 4	DAT08503						
400 Sportsman	05-13	3 4	DAT08503						
400 Xplorer	95-96	1 2 int.	DAT08503	1 2 ext.	DAT08507				
400 Xplorer	97-98	1 2	DAT08507						
400 Xplorer	99-02	1 2 3 4	DAT08503						
425 Magnum	95-96	1 2 int.	DAT08503	1 2 ext.	DAT08507				
425 Magnum	97-98	1 2	DAT08507						
425 Xpedition	00-01	1 2	DAT08507	3 4 5	DAT08503				
425 Xpedition	2002	1 2 3 4	DAT08503						
450 Sportsman	06-07	3 4	DAT08503						
455 Diesel	1999	1 2	DAT08507	3 4	DAT08503	8 9	DAT08501	7 10	DAT08502

€
22

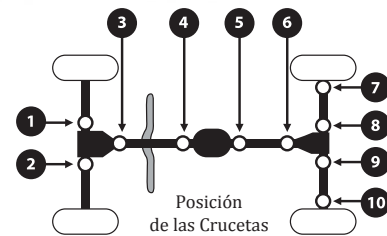

BRONCO Crucetas cardan

455 Diesel	2000	1 2	DAT08507							
455 Diesel	2001	1 2 int.	DAT08503	1 2 ext.	DAT08507	3 4	DAT08503			
500 ATP	2004	1 2 3 4	DAT08503	5	DAT08507					
500 ATP	2005	3 4	DAT08503	5 6	DAT08507					
500 Magnum	99-00	1 2	DAT08507	3 4	DAT08503					
500 Magnum HDS	2001	5	DAT08503							
500 Magnum HDS	2002	3 4 5	DAT08503							
500 Magnum	01-02	1 2	DAT08507	3 4 5	DAT08503					
500 Magnum	2003	3 4	DAT08503	5	DAT08507					
500 Ranger	04-09	3 4 5 6	DAT08503							
500 Ranger	10-12	3 4	DAT08503							
500 Scrambler	1997	1 2	DAT08507							
500 Scrambler	98-06	1 2	DAT08507	3 4	DAT08503					
500 Scrambler	10-12	3 4	DAT08503							
500 Sportsman	1996	1 2 int.	DAT08503	1 2 ext.	DAT08507	8 9	DAT08501	7 10	DAT08502	
500 Sportsman	1997	1 2 3 4	DAT08503	8 9	DAT08501	7 10	DAT08502			
500 Sportsman	1998	1 2	DAT08507	3 4	DAT08503	8 9	DAT08501	7 10	DAT08502	
500 Sportsman	99-01	1 2	DAT08507	3 4	DAT08503					
500 Sportsman HO	2001	1 2	DAT08507	3 4	DAT08503					
500 Sportsman HO	02-03	3 4	DAT08503							
500 Sportsman HO	2004	1 2	DAT08503	3 4 int.	DAT08503	3 4 ext.	DAT08507			
500 Sportsman HO	05-06	3 4	DAT08503							
500 Sportsman EFI	06-07	3 4 5 6	DAT08503							
500 Sportsman X2	06-07	5 6	DAT08503							
500 Sportsman HO	08-13	3 4	DAT08503							
500 Sportsman EFI	09-10	3 4 5 6	DAT08503							
500 Sportsman X2	08-09	3 4 5 6	DAT08503							
500 Worker 4x4	1999	1 2 3 4	DAT08507							
500 Xplorer 4x4	1997	1 2 3 4	DAT08503	8 9	DAT08501	7 10	DAT08502			
550 Sportsman	2011	3 4 5 6	DAT08503							
550 Sportsman	12-13	3 4	DAT08573							
550 Sportsman EFI	2010	3 4 5 6	DAT08503							
550 Sportsman EFI	11-13	3 4	DAT08573	5 6	DAT08503					
550 Sportsman XP	09-11	3 4 5 6	DAT08503	3 4	DAT08573					
550 Sportsman X2	2010	3 4 5 6	DAT08503							
550 Sportsman X2	11-12	5 6	DAT08503	3 4	DAT08573					
570 RZR	12-13	3 4	DAT08503							
570 Sportsman ACE	2015	3 4	DAT08495							
600 Sportsman 4x4	03-04	1 2 3 4 5 6	DAT08503							
600 Sportsman 4x4	2005	3 4 5 6	DAT08503							
700 Ranger TM	04-06	5 6	DAT08503							
700 Ranger EFI	05-09	3 4 5 6	DAT08503							
700 Sportsman	02-04	1 2 3 4 5 6	DAT08503							
700 Sportsman	05-06	3 4 5 6	DAT08503							
700 Sportsman EFI	03-04	1 2 3 4 5 6	DAT08503							
700 Sportsman EFI	05-07	3 4 5 6	DAT08503							
700 Sportsman X2	2008	3 4 5 6	DAT08503							
800 Sportsman EFI	05-13	3 4	DAT08503							
800 Sportsman X2	07-09	3 4 5 6	DAT08503							
800 Sportsman Forest	12-13	3 4 5 6	DAT08503							
850 Sportsman	11-13	3 4	DAT08573							
850 Sportsman Forest	2010	3 4 5 6	DAT08503							
850 Sportsman Forest	11-13	5 6	DAT08503	3 4	DAT08573					
850 Sportsman Touring	2010	3 4 5 6	DAT08503							
850 Sportsman Touring	11-13	5 6	DAT08503	3 4	DAT08573					
850 Sportsman XP	09-10	3 4 5 6	DAT08503							
850 Sportsman XP	11-13	5 6	DAT08503	3 4	DAT08573					
850 Sportsman X2	2010	3 4 5 6	DAT08503							
850 Sportsman X2	2011	5 6	DAT08503	3 4	DAT08573					
900 RZR XP	2010	3 4	DAT08503							
900 RZR XP	11-13	3 4	DAT08573							
900 RZR XP "4"	12-13	3 4	DAT08503							
900 RZR XP	2015	3 4 5 6	DAT08495							

RUEDAS Y NEUMÁTICOS

MOTOR

ADMISIÓN / ESCAPE
REFRIGERACIÓN

ELÉCTRICO

SUSPENSIÓN / DIRECCIÓN

FRENOS

TRANSMISIÓN

CONTROLES Y MANDOS

CHASIS

ACCESORIOS



Palier completo

Sustituye el palier original a un precio inigualable.



Palier completo super reforzado "HD"

Sustituye el palier original por un palier super reforzado, a un precio inigualable
(Todas las referencias que terminan en HD son de palieres super reforzados)

	PALIER DELANTERO IZQUIERDO		PALIER DELANTERO DERECHO		PALIER TRASERO IZQUIERDO		PALIER TRASERO DERECHO	
ARCTIC CAT								
Año	Referencia	€	Referencia	€	Referencia	€	Referencia	€
550 Prowler	09-14	PD2016HD	327,60	PD2017HD	327,60			
650 Prowler	06-09	PD2016HD	327,60	PD2017HD	327,60			
700 Prowler	08-10	PD2016HD	327,60	PD2017HD	327,60	PD2016HD	327,60	PD2016HD
700 Prowler	11-14	PD2017HD	327,60	PD2016HD	327,60			
700 Wildcat Sport	15-16	PD2022HD	411,60	PD2022HD	411,60	PD2023HD	411,60	PD2023HD
700 Wildcat Trail	14-15	PD2018HD	374,43	PD2018HD	374,43	PD2019HD	374,43	PD2019HD
1000 Prowler	09-14	PD2017HD	327,60	PD2016HD	327,60			
1000 ATV	11-14	PD1153HD	348,60	PD1154HD	348,60	PD1152HD	348,60	PD1152HD
1000 Wildcat	12-14	PD1163HD	348,60	PD1163HD	348,60	PD1162HD	348,60	PD1162HD
1000 Wildcat Trail	14-15	PD2018HD	374,43	PD2018HD	374,43	PD2019HD	374,43	PD2019HD
1000 Wildcat X	13-16	PD1163HD	348,60	PD1163HD	348,60	PD1162HD	348,60	PD1162HD
1000 Wildcat 4	13-15	PD1163HD	348,60	PD1163HD	348,60	PD1162HD	348,60	PD1162HD
CAN AM								
Año	Referencia	€	Referencia	€	Referencia	€	Referencia	€
400 Outlander	06-08	PD1128HD	369,60	PD1127HD	369,60			
400 Outlander	09-12	PD1128HD	369,60	PD1127HD	369,60	PD1130HD	369,60	PD1129HD
400 Outlander	13-15	PD1128HD	369,60	PD1127HD	369,60	PD3021HD	374,43	PD3022HD
400 Outlander MAX	06-08	PD1128HD	369,60	PD1127HD	369,60			
400 Outlander MAX	09-15	PD1128HD	369,60	PD1127HD	369,60	PD1130HD	369,60	PD1129HD
500 Outlander	07-12	PD1128HD	369,60	PD1127HD	369,60	PD1130HD	369,60	PD1129HD
500 Outlander	13-15	PD3016HD	420,25	PD3017HD	420,25	PD1130HD	369,60	PD1129HD
500 Outlander MAX	07-12	PD1128HD	369,60	PD1127HD	369,60	PD1130HD	369,60	PD1129HD
500 Outlander MAX	13-15	PD3016HD	420,25	PD3017HD	420,25	PD1130HD	369,60	PD1129HD
500 Renegade	08-12	PD1128HD	369,60	PD1127HD	369,60	PD1130HD	369,60	PD1129HD
500 Renegade	13-15	PD3016HD	420,25	PD3017HD	420,25	PD1130HD	369,60	PD1129HD
570 Outlander	2016	PD3016HD	420,25	PD3017HD	420,25	PD1130HD	369,60	PD1129HD
650 Outlander	07-12	PD1128HD	369,60	PD1127HD	369,60	PD1130HD	369,60	PD1129HD
650 Outlander	13-16	PD3016HD	420,25	PD3017HD	420,25	PD1130HD	369,60	PD1129HD
650 Outlander MAX	07-12	PD1128HD	369,60	PD1127HD	369,60	PD1130HD	369,60	PD1129HD
650 Outlander MAX	13-16	PD3016HD	420,25	PD3017HD	420,25	PD1130HD	369,60	PD1129HD
650 Outlander XMR	13-15	PD3016HD	420,25	PD3017HD	420,25	PD1130HD	369,60	PD1129HD
800 Commander	11-15	PD3001HD	369,60	PD3002HD	369,60	PD1156HD	369,60	PD1156HD
800 Commander	2016	PD3001HD	369,60	PD3002HD	369,60	PD3034HD	374,43	PD3034HD
800 Outlander	07-12	PD1128HD	369,60	PD1127HD	369,60	PD1130HD	369,60	PD1129HD
800 Outlander	13-15	PD3016HD	420,25	PD3017HD	420,25	PD1130HD	369,60	PD1129HD
800 Outlander MAX	07-12	PD1128HD	369,60	PD1127HD	369,60	PD1130HD	369,60	PD1129HD
800 Outlander MAX	13-15	PD3016HD	420,25	PD3017HD	420,25	PD1130HD	369,60	PD1129HD
800 Renegade	07-12	PD1128HD	369,60	PD1127HD	369,60	PD1130HD	369,60	PD1129HD
800 Renegade	13-15	PD3016HD	420,25	PD3017HD	420,25	PD1130HD	369,60	PD1129HD
850 Outlander	2016	PD3016HD	420,25	PD3017HD	420,25	PD1130HD	369,60	PD1129HD
850 Outlander Max	2016	PD3016HD	420,25	PD3017HD	420,25	PD1130HD	369,60	PD1129HD
850 Renegade	2016	PD3016HD	420,25	PD3017HD	420,25	PD1130HD	369,60	PD1129HD
1000 Commander	11-15	PD3001HD	369,60	PD3002HD	369,60	PD1156HD	369,60	PD1156HD
1000 Commander	2016	PD3001HD	369,60	PD3002HD	369,60	PD3034HD	374,43	PD3034HD
1000 Maverick STD	13-15	PD3011HD	369,60	PD3012HD	369,60	PD3015HD	411,06	PD3015HD
1000 Maverick STD	2016	PD3011HD	369,60	PD3012HD	369,60			
1000 Maverick DPS	2015	PD3011HD	369,60	PD3012HD	369,60	PD3015HD	411,06	PD3015HD
1000 Maverick DPS	2016	PD3011HD	369,60	PD3012HD	369,60			
1000 Maverick Turbo	2016	PD3011HD	369,60	PD3012HD	369,60	PD3023HD	443,35	PD3023HD
1000 Maverick XC	2016	PD3018HD	420,25	PD3019HD	374,43	PD3020HD	443,35	PD3020HD
1000 Maverick XDS	15-16	PD3011HD	369,60	PD3012HD	369,60	PD3023HD	443,35	PD3023HD
1000 Maverick XDX Turbo	2016	PD3011HD	369,60	PD3012HD	369,60	PD3023HD	443,35	PD3023HD



		PALIER DELANTERO IZQUIERDO		PALIER DELANTERO DERECHO		PALIER TRASERO IZQUIERDO		PALIER TRASERO DERECHO	
1000 Maverick XMR	2014	PD3011HD	369,60	PD3012HD	369,60	PD3015HD	411,06	PD3015HD	411,06
1000 Maverick XMR	2016	PD3011HD	369,60	PD3012HD	369,60				
1000 Maverick XRS	13-15	PD3011HD	369,60	PD3012HD	369,60	PD3015HD	411,06	PD3015HD	411,06
1000 Maverick XRS Turbo	2016	PD3011HD	369,60	PD3012HD	369,60	PD3023HD	443,35	PD3023HD	443,35
1000 Maverick XXC	14-16	PD3018HD	420,25	PD3019HD	374,43	PD3020HD	443,35	PD3020HD	443,35
1000 Outlander	2012	PD1128HD	369,60	PD1127HD	369,60	PD1130HD	369,60	PD1129HD	369,60
1000 Outlander	13-16	PD3016HD	420,25	PD3017HD	420,25	PD1130HD	369,60	PD1129HD	369,60
1000 Outlander MAX	13-16	PD3016HD	420,25	PD3017HD	420,25	PD1130HD	369,60	PD1129HD	369,60
1000 Outlander XMR	13-14	PD3014	327,60	PD3013	327,60	PD1130HD	369,60	PD1129HD	369,60
1000 Renegade	2012	PD1128HD	369,60	PD1127HD	369,60	PD1130HD	369,60	PD1129HD	369,60
1000 Renegade	13-16	PD3016HD	420,25	PD3017HD	420,25	PD1130HD	369,60	PD1129HD	369,60
		PALIER DELANTERO IZQUIERDO		PALIER DELANTERO DERECHO		PALIER TRASERO IZQUIERDO		PALIER TRASERO DERECHO	
CF MOTO									
Año	Referencia	€	Referencia	€	Referencia	€	Referencia	€	
Z8-EX Terracross	14-16	PD14017HD	273,00	PD14018HD	273,00	PD14019HD	273,00	PD14020HD	273,00
		PALIER DELANTERO IZQUIERDO		PALIER DELANTERO DERECHO		PALIER TRASERO IZQUIERDO		PALIER TRASERO DERECHO	
HONDA									
Año	Referencia	€	Referencia	€	Referencia	€	Referencia	€	
TRX 350 Rancher	00-05	PD1085	237,30	PD1085	237,30				
TRX 400 Rancher	95-01	PD1122	237,30	PD1072	237,30				
TRX 400 Rancher	04-07	PD1082	237,30	PD1082	237,30				
TRX 420 Rancher	07-08	PD4007HD	327,60	PD4007HD	327,60				
TRX 420 Rancher	09-14	PD4007HD	327,60	PD4007HD	327,60	PD4010HD	327,60	PD4011HD	327,60
TRX 450 Foreman	98-04	PD1068	237,30	PD1076	237,30				
TRX 500 Foreman	01-04	PD1066	237,30	PD1074	237,30				
TRX 500 Foreman	05-07	PD1071	237,30	PD1079	237,30				
TRX 500 Foreman	08-09	PD4001	237,30	PD4002	237,30				
TRX 500 Foreman	11-12	PD1071	237,30	PD1079	237,30				
TRX 650 Rincon	03-05	PD4024HD	327,60	PD4025HD	327,60	PD1080HD	374,43	PD1080HD	374,43
TRX 680 Rincon	06-15	PD4024HD	327,60	PD4025HD	327,60	PD1080HD	374,43	PD1080HD	374,43
		PALIER DELANTERO IZQUIERDO		PALIER DELANTERO DERECHO		PALIER TRASERO IZQUIERDO		PALIER TRASERO DERECHO	
KAWASAKI									
Año	Referencia	€	Referencia	€	Referencia	€	Referencia	€	
KVF 360 Prairie	03-12	PD1105	237,30	PD1013	237,30				
KVF 650 Brute Force	05-13	PD1105	237,30	PD1013	237,30				
KVF 650i Brute Force	06-13	PD1106HD	348,60	PD1107HD	348,60	PD1112HD	327,60	PD1112HD	327,60
KVF 650 Prairie	02-03	PD1105	237,30	PD1013	237,30				
KVF 700 Prairie	04-06	PD1105	237,30	PD1013	237,30				
KVF 750i Brute Force	05-16	PD1106HD	374,43	PD1107HD	374,43	PD1112HD	327,60	PD1112HD	327,60
KRF 750 Teryx	08-13	PD1131HD	327,60	PD1131HD	327,60	PD1113HD	298,20	PD1114HD	298,20
		PALIER DELANTERO IZQUIERDO		PALIER DELANTERO DERECHO		PALIER TRASERO IZQUIERDO		PALIER TRASERO DERECHO	
POLARIS									
Año	Referencia	€	Referencia	€	Referencia	€	Referencia	€	
Ranger 400	10-14	PD1135HD	327,60	PD1135HD	327,60	PD1136HD	327,60	PD1136HD	327,60
Ranger 500	2009	PD6058HD	348,60	PD6058HD	348,60				
Ranger 500	2010	PD6058HD	348,60	PD6058HD	348,60	PD1134HD	327,60	PD1134HD	327,60
Ranger 500	11-13	PD1135HD	327,60	PD1135HD	327,60	PD1136HD	327,60	PD1136HD	327,60
Ranger 570	2015	PD6058HD	348,60	PD6058HD	348,60	PD6070HD	374,43	PD6070HD	374,43
Ranger 570	2016	PD6064HD	374,43	PD6064HD	374,43	PD6070HD	374,43	PD6070HD	374,43
Ranger 700	2009	PD6058HD	348,60	PD6058HD	348,60				
Ranger 800	10-14	PD6058HD	348,60	PD6058HD	348,60	PD1134HD	327,60	PD1134HD	327,60
Ranger 800	15-16	PD6058HD	348,60	PD6058HD	348,60				
Ranger 900 XP	13-17	PD6058HD	348,60	PD6058HD	348,60	PD1134HD	327,60	PD1134HD	327,60
Ranger 1000	15-17	PD6058HD	348,60	PD6058HD	348,60				
Ranger EV	10-15					PD1136HD	327,60	PD1136HD	327,60
Ranger LSV	11-12					PD1136HD	327,60	PD1136HD	327,60
RZR 570	12-15	PD6029HD	327,60	PD6029HD	327,60	PD6069HD	369,60	PD6069HD	369,60
RZR 800	08-14	PD6029HD	327,60	PD6029HD	327,60	PD1138HD	327,60	PD1138HD	327,60
RZR 800 S	09-14	PD6067HD	369,60	PD6067HD	369,60	PD6005HD	374,43	PD6005HD	374,43
RZR 800 4	10-14	PD6067HD	369,60	PD6067HD	369,60	PD6005HD	374,43	PD6005HD	374,43

TRANSMISIÓN



		PALIER DELANTERO IZQUIERDO		PALIER DELANTERO DERECHO		PALIER TRASERO IZQUIERDO		PALIER TRASERO DERECHO	
RZR 900 XP	11-14	PD6016HD	327,60	PD6016HD	327,60	PD1158HD	327,60	PD1158HD	327,60
RZR 900 XP	15-17	PD6061HD	327,60	PD6061HD	327,60	PD6062HD	374,43	PD6062HD	374,43
RZR 1000 XP	14-17	PD6057HD	348,60	PD6057HD	348,60	PD6052HD	369,60	PD6052HD	369,60
RZR 1000 XP Turbo	16-17	PD6074HD	340,20	PD6074HD	340,20	PD6052HD	369,60	PD6052HD	369,60
RZR 1000 XP "4"	14-17	PD6057HD	348,60	PD6057HD	348,60	PD6052HD	369,60	PD6052HD	369,60
Scrambler 400	95-02	PD1006U	273,00	PD1006U	273,00				
Scrambler 500	97-09	PD1006U	273,00	PD1006U	273,00				
Scrambler 850	13-17	PD6029HD	327,60	PD6029HD	327,60	PD1132HD	327,60	PD1132HD	327,60
Scrambler 1000	14-17	PD6029HD	327,60	PD6029HD	327,60	PD1132HD	327,60	PD1132HD	327,60
Sportsman 325 ACE	15-16	PD6068HD	374,43	PD6068HD	374,43	PD6069HD	374,43	PD6069HD	374,43
Sportsman 335	2000	PD1006U	273,00	PD1006U	273,00	PD6008HD	374,43	PD6008HD	374,43
Sportsman 400	01-02	PD1006U	273,00	PD1006U	273,00	PD6008HD	374,43	PD6008HD	374,43
Sportsman 400	03-04	PD1006U	273,00	PD1006U	273,00	PD1018HD	327,60	PD1018HD	327,60
Sportsman 400	2005					PD1018HD	327,60	PD1018HD	327,60
Sportsman 400	11-13					PD1018HD	327,60	PD1018HD	327,60
Sportsman 400	2014					PD1018HD	327,60	PD1018HD	327,60
Sportsman 450	2006	PD1117	237,30	PD1117	237,30	PD1018HD	327,60	PD1018HD	327,60
Sportsman 450	2007	PD1157HD	327,60	PD1157HD	327,60	PD1018HD	327,60	PD1018HD	327,60
Sportsman 450	2016	PD6075HD	340,20	PD6075HD	340,20	PD6076HD	340,20	PD6076HD	340,20
Sportsman 500	99-02	PD1006U	273,00	PD1006U	273,00	PD6008HD	374,43	PD6008HD	374,43
Sportsman 500	03-04	PD1006U	273,00	PD1006U	273,00	PD1018HD	327,60	PD1018HD	327,60
Sportsman 500	2005	PD1157HD	327,60	PD1157HD	327,60	PD1018HD	327,60	PD1018HD	327,60
Sportsman 500	06-07					PD1018HD	327,60	PD1018HD	327,60
Sportsman 500	08-11	PD1157HD	327,60	PD1157HD	327,60				
Sportsman 500	2012	PD1157HD	327,60	PD1157HD	327,60	PD1018HD	327,60	PD1018HD	327,60
Sportsman 500	13-14					PD1018HD	327,60	PD1018HD	327,60
Sportsman 500 ACE	2017	PD6068HD	374,43	PD6068HD	374,43	PD6069HD	374,43	PD6069HD	374,43
Sportsman 500 Touring	08-13	PD1157HD	327,60	PD1157HD	327,60				
Sportsman 500 X2	2007	PD1157HD	327,60	PD1157HD	327,60	PD1018HD	327,60	PD1018HD	327,60
Sportsman 500 X2	06-09	PD1157HD	327,60	PD1157HD	327,60				
Sportsman 550	09-14	PD6029HD	327,60	PD6029HD	327,60	PD1132HD	327,60	PD1132HD	327,60
Sportsman 550 Touring	10-14	PD6029HD	327,60	PD6029HD	327,60	PD1132HD	327,60	PD1132HD	327,60
Sportsman 550 X2	10-14	PD6029HD	327,60	PD6029HD	327,60	PD1132HD	327,60	PD1132HD	327,60
Sportsman 570	2014	PD6075HD	340,20	PD6075HD	340,20	PD1018HD	327,60	PD1132HD	327,60
Sportsman 570	15-16	PD6075HD	340,20	PD6075HD	340,20	PD6076HD	340,20	PD6076HD	340,20
Sportsman 570 ACE	15-17	PD6068HD	374,43	PD6068HD	374,43	PD6069HD	374,43	PD6069HD	374,43
Sportsman 600	2003	PD1007U	273,00	PD1007U	273,00	PD1018HD	327,60	PD1018HD	327,60
Sportsman 600	2004					PD1018HD	327,60	PD1018HD	327,60
Sportsman 600	2005	PD1157HD	327,60	PD1157HD	327,60	PD1018HD	327,60	PD1018HD	327,60
Sportsman 700	03-04					PD1018HD	327,60	PD1018HD	327,60
Sportsman 700	2005	PD1157HD	327,60	PD1157HD	327,60	PD1018HD	327,60	PD1018HD	327,60
Sportsman 700	2006					PD1018HD	327,60	PD1018HD	327,60
Sportsman 700	2007	PD1157HD	327,60	PD1157HD	327,60	PD1018HD	327,60	PD1018HD	327,60
Sportsman 700	2008	PD1157HD	327,60	PD1157HD	327,60				
Sportsman 800	05-12	PD1157HD	327,60	PD1157HD	327,60	PD1018HD	327,60	PD1018HD	327,60
Sportsman 800	13-14					PD1018HD	327,60	PD1018HD	327,60
Sportsman 800 Touring	08-09	PD1157HD	327,60	PD1157HD	327,60				
Sportsman 800 X2	2007	PD1157HD	327,60	PD1157HD	327,60	PD1018HD	327,60	PD1018HD	327,60
Sportsman 800 X2	08-09	PD1157HD	327,60	PD1157HD	327,60				
Sportsman 850	09-17	PD6029HD	327,60	PD6029HD	327,60	PD1132HD	327,60	PD1132HD	327,60
Sportsman 850 Touring	10-17	PD6029HD	327,60	PD6029HD	327,60	PD1132HD	327,60	PD1132HD	327,60
Sportsman 900 ACE	2016	PD6068HD	374,43	PD6068HD	374,43	PD6069HD	374,43	PD6069HD	374,43
Sportsman 900 ACE	2017					PD1134HD	327,60	PD1134HD	327,60
Sportsman 1000	15-17	PD6029HD	327,60	PD6029HD	327,60	PD1132HD	327,60	PD1132HD	327,60
Sportsman 1000 Touring	2015	PD6029HD	327,60	PD6029HD	327,60	PD1132HD	327,60	PD1132HD	327,60



	PALIER DELANTERO IZQUIERDO	PALIER DELANTERO DERECHO	PALIER TRASERO IZQUIERDO	PALIER TRASERO DERECHO
--	----------------------------	--------------------------	--------------------------	------------------------

SUZUKI	Año	Referencia	€	Referencia	€	Referencia	€	Referencia	€
LT-A 400 King Quad	08-14	PD7006	285,60	PD7005	285,60				
LT-A 450 King Quad	07-10	PD1125HD	369,60	PD1125HD	369,60	PD1124HD	327,60	PD1124HD	327,60
LT-A 500 King Quad	11-15	PD1125HD	369,60	PD1125HD	369,60	PD1124HD	327,60	PD1124HD	327,60
LT-A 500 Vinson	04-07	PD7001	237,30	PD7002	237,30				
LT-A 700 King Quad	2005					PD1124HD	327,60	PD1124HD	327,60
LT-A 700 King Quad	06-07	PD1125HD	369,60	PD1125HD	369,60	PD1124HD	327,60	PD1124HD	327,60
LT-A 750 King Quad	08-15	PD1125HD	369,60	PD1125HD	369,60	PD1124HD	327,60	PD1124HD	327,60

	PALIER DELANTERO IZQUIERDO	PALIER DELANTERO DERECHO	PALIER TRASERO IZQUIERDO	PALIER TRASERO DERECHO
--	----------------------------	--------------------------	--------------------------	------------------------

YAMAHA	Año	Referencia	€	Referencia	€	Referencia	€	Referencia	€
YFM 350 Big Bear	97-99	PD1097	237,30	PD1097	237,30				
YFM 350 Grizzly	07-11	PD8007	237,30	PD8008	237,30				
YFM 400 Big Bear	00-01	PD1097	237,30	PD1097	237,30				
YFM 400 Big Bear	02-06	PD1100	237,30	PD1100	237,30				
YFM 400 Big Bear	07-11	PD8007	237,30	PD8008	237,30	PD8012	237,30	PD8013	237,30
YFM 400 Grizzly	2007	PD1098	237,30	PD1098	237,30	PD1101	237,30	PD1101	237,30
YFM 400 Grizzly	2008	PD1098	237,30	PD1098	237,30				
YFM 400 Kodiak	1999	PD1097	237,30	PD1097	237,30				
YFM 400 Kodiak	00-04	PD1098	237,30	PD1098	237,30				
YFM 400 Kodiak	05-06	PD1098	237,30	PD1098	237,30	PD1101	237,30	PD1101	237,30
YFM 450 Grizzly	08-11	PD8007	237,30	PD8008	237,30				
YFM 450 Grizzly	2007	PD1087	237,30	PD1090	237,30	PD1101	237,30	PD1101	237,30
YFM 450 Kodiak	03-04	PD1087	237,30	PD1090	237,30				
YFM 450 Kodiak	05-06	PD1087	237,30	PD1090	237,30	PD1101	237,30	PD1101	237,30
YFM 550 Grizzly	09-14	PD1139HD	327,60	PD1139HD	327,60	PD1104HD	327,60	PD1104HD	327,60
YFM 660 Grizzly	03-08	PD1088HD	327,60	PD1091HD	327,60	PD1092HD	327,60	PD1093HD	327,60
YFM 700 Grizzly	07-13	PD1139HD	327,60	PD1139HD	327,60	PD1104HD	327,60	PD1104HD	327,60
YFM 700 Grizzly	14-15	PD8016HD	420,25	PD8016HD	420,25	PD8017	237,30	PD8017	237,30
YFM 700 Kodiak	16-17	PD8016HD	420,25	PD8016HD	420,25				
YXR 450 Rhino	06-09	PD8001HD	327,60	PD8002HD	327,60	PD1102HD	327,60	PD1103HD	327,60
YXR 660 Rhino	04-05					PD1102HD	327,60	PD1103HD	327,60
YXR 660 Rhino	06-07	PD8001HD	327,60	PD8002HD	327,60	PD1102HD	327,60	PD1103HD	327,60
YXE 700 Wolverine	16-17	PD8014HD	374,43	PD8014HD	374,43	PD8015HD	374,43	PD8015HD	374,43
YXM 700 Viking	14-16	PD8014HD	374,43	PD8014HD	374,43	PD8015HD	374,43	PD8015HD	374,43
YXR 700 Rhino	08-13	PD8001HD	327,60	PD8001HD	327,60	PD1102HD	327,60	PD1103HD	327,60
YXZ 1000 R	16-17	PD8018HDD	374,43	PD8018HDD	374,43	PD8019HDD	374,43	PD8019HDD	374,43



€ 127,46 € 140,90



Punteras completas



		PUNTERA DELANTERA IZQUIERDA		PUNTERA DELANTERA DERECHA		PUNTERA TRASERA IZQUIERDA		PUNTERA TRASERA DERECHA	
CAN AM									
Año	Exterior	Interior	Exterior	Interior	Exterior	Interior	Exterior	Interior	
400 Outlander	03-05	PDV1071	PDV1071	PDV1071	PDV1071	PDV1075	PDV1075	PDV1075	
400 Outlander	06-08	PDV1074	PDV1074	PDV1074	PDV1074	PDV1075	PDV1075	PDV1075	
400 Outlander	09-12	PDV1074	PDV1074	PDV1074	PDV1074	PDV1075	PDV1075	PDV1075	
400 Outlander MAX	06-08	PDV1074	PDV1074	PDV1074	PDV1074	PDV1075	PDV1075	PDV1075	
400 Outlander MAX	09-12	PDV1074	PDV1074	PDV1074	PDV1074	PDV1075	PDV1075	PDV1075	
500 Outlander	2007	PDV1074	PDV1074	PDV1074	PDV1074	PDV1076	PDV1076	PDV1076	
500 Outlander	08-12	PDV1074	PDV1074	PDV1074	PDV1074	PDV1076	PDV1076	PDV1076	
500 Outlander MAX	2007	PDV1074	PDV1074	PDV1074	PDV1074	PDV1076	PDV1076	PDV1076	
500 Outlander MAX	08-12	PDV1074	PDV1074	PDV1074	PDV1074	PDV1076	PDV1076	PDV1076	
500 Renegade	08-12	PDV1074	PDV1074	PDV1074	PDV1074	PDV1076	PDV1076	PDV1076	
650 Outlander	06-07	PDV1074	PDV1074	PDV1074	PDV1074	PDV1076	PDV1076	PDV1076	
650 Outlander	08-12	PDV1074	PDV1074	PDV1074	PDV1074	PDV1076	PDV1076	PDV1076	
650 Outlander MAX	06-07	PDV1074	PDV1074	PDV1074	PDV1074	PDV1076	PDV1076	PDV1076	
650 Outlander MAX	08-12	PDV1074	PDV1074	PDV1074	PDV1074	PDV1076	PDV1076	PDV1076	
800 Outlander	2006	PDV1074	PDV1074	PDV1074	PDV1074	PDV1076	PDV1076	PDV1076	
800 Outlander	07-12	PDV1074	PDV1074	PDV1074	PDV1074	PDV1076	PDV1076	PDV1076	
800 Outlander MAX	06-07	PDV1074	PDV1074	PDV1074	PDV1074	PDV1076	PDV1076	PDV1076	
800 Outlander MAX	08-12	PDV1074	PDV1074	PDV1074	PDV1074	PDV1076	PDV1076	PDV1076	
800 Renegade	2007	PDV1074	PDV1074	PDV1074	PDV1074	PDV1076	PDV1076	PDV1076	
800 Renegade	08-12	PDV1074	PDV1074	PDV1074	PDV1074	PDV1076	PDV1076	PDV1076	
1000 Renegade	2012	PDV1074	PDV1074	PDV1074	PDV1074	PDV1076	PDV1076	PDV1076	
HONDA									
Año	Exterior	Interior	Exterior	Interior	Exterior	Interior	Exterior	Interior	
TRX 350 Rancher	00-05	PDV1030	PDV1143	PDV1030	PDV1143				
TRX 350 Rancher	2006	PDV1030	PDV1030	PDV1030	PDV1030				
TRX 400 Rancher	95-03	PDV1001	PDV1001	PDV1001	PDV1001				
TRX 400 Rancher	04-07	PDV1030	PDV1030	PDV1030	PDV1030				
TRX 420 Rancher	07-09	PDV1126	PDV1126	PDV1126	PDV1126				
TRX 450 Foreman	98-04	PDV1001	PDV1134	PDV1001	PDV1134				
TRX 500 Foreman	01-04	PDV1015	PDV1134	PDV1015	PDV1134				
TRX 500 Foreman	05-07	PDV1015	PDV1143	PDV1015	PDV1143				
TRX 500 Foreman	08-13	PDV1126	PDV1143	PDV1126	PDV1143				
TRX 650 Rincon	03-04	PDV1015	PDV1015	PDV1015	PDV1015	PDV1062	PDV1062	PDV1062	
TRX 650 Rincon	2005	PDV1015	PDV1143	PDV1015	PDV1143	PDV1062	PDV1062	PDV1062	
TRX 680 Rincon	06-07	PDV1015	PDV1143	PDV1015	PDV1143	PDV1062	PDV1062	PDV1062	
TRX 680 Rincon	08-13	PDV1126	PDV1143	PDV1126	PDV1143	PDV1062	PDV1062	PDV1062	
KAWASAKI									
Año	Exterior	Interior	Exterior	Interior	Exterior	Interior	Exterior	Interior	
KVF 400 Prairie	97-02	PDV1010	PDV1087	PDV1010	PDV1087				
KVF 650 Brute Force	05-09	PDV1109	PDV1103	PDV1109	PDV1102				
KVF 650 Brute Force	10-13	PDV1103	PDV1103	PDV1103	PDV1102				
KVF 650i Brute Force	06-08	PDV1163	PDV1103	PDV1163	PDV1102	PDV1069	PDV1105	PDV1105	
KVF 650i Brute Force	09-13	PDV1163	PDV1103	PDV1163	PDV1102	PDV1069	PDV1123	PDV1123	
KVF 650 Prairie	02-03	PDV1023	PDV1101	PDV1023	PDV1100				
KVF 700 Prairie	04-06	PDV1109	PDV1103	PDV1109	PDV1102				
KVF 750i Brute Force	05-07	PDV1163	PDV1103	PDV1163	PDV1102	PDV1069	PDV1105	PDV1105	
KVF 750i Brute Force	08-11	PDV1164	PDV1164	PDV1164	PDV1164	PDV1069	PDV1123	PDV1123	
KVF 750i Brute Force	12-13	PDV1163	PDV1103	PDV1163	PDV1102	PDV1069	PDV1123	PDV1123	
KRF 750 Teryx	2008	PDV1124	PDV1124	PDV1124	PDV1124	PDV1125	PDV1122	PDV1122	
KRF 750 Teryx	09-12	PDV1124	PDV1123	PDV1124	PDV1123	PDV1125	PDV1122	PDV1122	
POLARIS									
Año	Exterior	Interior	Exterior	Interior	Exterior	Interior	Exterior	Interior	
Scrambler 400	99-02	PDV1004	PDV1004	PDV1004	PDV1004				
Scrambler 500	99-09	PDV1004	PDV1004	PDV1004	PDV1004				
Sportsman 500	08-10	PDV1129	PDV1129	PDV1129	PDV1129	PDV1140	PDV1140	PDV1140	
Sportsman 500	11-14	PDV1129	PDV1129	PDV1129	PDV1129	PDV1174	PDV1174	PDV1174	
RZR 570	12-15	PDV1118	PDV1115	PDV1118	PDV1115				
Ranger 700	2005	PDV1155	PDV1155	PDV1155	PDV1155	PDV1027	PDV1160	PDV1160	



Punteras completas

€
127,46

€
140,90

Ranger 700	06-07	PDV1064	PDV1091	PDV1064	PDV1091	PDV1027	PDV1160	PDV1027	PDV1159
Ranger 700	08-09	PDV1138		PDV1138		PDV1140		PDV1140	
Sportsman 700	03-04	PDV1017		PDV1017		PDV1027	PDV1090	PDV1027	PDV1090
Sportsman 700	2005	PDV1136	PDV1091	PDV1136	PDV1091	PDV1027	PDV1090	PDV1027	PDV1090
Sportsman 700	2006	PDV1156		PDV1156		PDV1130	PDV1090	PDV1130	PDV1090
Sportsman 700	2008	PDV1129		PDV1129					
Ranger 800	2010	PDV1139		PDV1139		PDV1142		PDV1142	
RZR 800	08-10	PDV1118	PDV1115	PDV1118	PDV1115	PDV1119	PDV1116	PDV1119	PDV1116
RZR 800	11-14	PDV1118	PDV1115	PDV1118	PDV1115				
Sportsman 800	08-10	PDV1129		PDV1129		PDV1140		PDV1140	
Ranger 900	11-12					PDV1174		PDV1174	
Ranger 900	13-15	PDV1118	PDV1115	PDV1118	PDV1115	PDV1174		PDV1174	
RZR 900 XP	11-14	PDV1173		PDV1173		PDV1174		PDV1174	
Ranger 1000	2015	PDV1118	PDV1115	PDV1118	PDV1115	PDV1174		PDV1174	
RZR 1000 XP	14-15	PDV1173		PDV1173					

	PUNTERA DELANTERA IZQUIERDA	PUNTERA DELANTERA DERECHA	PUNTERA TRASERA IZQUIERDA	PUNTERA TRASERA DERECHA
--	-----------------------------	---------------------------	---------------------------	-------------------------

SUZUKI	Año	Exterior	Interior	Exterior	Interior	Exterior	Interior	Exterior	Interior
LT-A 400 Eiger	2002	PDV1128		PDV1128					
LT-A 400 Eiger "68LAC"	03-04	PDV1128		PDV1128					
LT-A 400 Eiger "UJ68"	03-04	PDV1145		PDV1145					
LT-A 400 Eiger	05-07	PDV1128		PDV1128					
LT-A 450 King Quad	07-10	PDV1172	PDV1176	PDV1172	PDV1176	PDV1171	PDV1175	PDV1171	PDV1175
LT-A 500 King Quad	09-12	PDV1172		PDV1172		PDV1171	PDV1175	PDV1171	PDV1175
LT-A 500 King Quad PS	11-12	PDV1172	PDV1176	PDV1172	PDV1176	PDV1171	PDV1175	PDV1171	PDV1175
LT-A 500 Vinson	2002	PDV1128		PDV1128					
LT-A 500 Vinson	03-05	PDV1145		PDV1145					
LT-A 500 Vinson	06-07	PDV1128		PDV1128					
LT-A 700 King Quad	2005	PDV1144		PDV1144		PDV1131		PDV1131	
LT-A 700 King Quad	2006	PDV1144		PDV1144					
LT-A 700 King Quad "18 dientes"	2007					PDV1131		PDV1131	
LT-A 700 King Quad "26 dientes"	2007					PDV1171	PDV1175	PDV1171	PDV1175
LT-A 750 King Quad	08-14	PDV1172	PDV1176	PDV1172	PDV1176	PDV1171	PDV1175	PDV1171	PDV1175

	PUNTERA DELANTERA IZQUIERDA	PUNTERA DELANTERA DERECHA	PUNTERA TRASERA IZQUIERDA	PUNTERA TRASERA DERECHA
--	-----------------------------	---------------------------	---------------------------	-------------------------

YAMAHA	Año	Exterior	Interior	Exterior	Interior	Exterior	Interior	Exterior	Interior
YFM 350 Big Bear	97-99	PDV1002	PDV1087	PDV1002	PDV1087				
YFM 350 Grizzly	07-11	PDV1026	PDV1127	PDV1026	PDV1127				
YFM 350 Grizzly	12-14	PDV1162	PDV1078	PDV1162	PDV1078				
YFM 400 Big Bear	00-01	PDV1002	PDV1087	PDV1002	PDV1087				
YFM 400 Big Bear	02-06		PDV1127	PDV1002	PDV1127				
YFM 400 Big Bear	07-12	PDV1162	PDV1078	PDV1162	PDV1078	PDV1058	PDV1085	PDV1058	PDV1085
YFM 400 Grizzly	2007	PDV1026	PDV1127	PDV1026	PDV1127	PDV1058	PDV1085	PDV1058	PDV1085
YFM 400 Kodiak	00-04	PDV1026	PDV1127	PDV1026	PDV1127				
YFM 400 Kodiak	05-06	PDV1026	PDV1127	PDV1026	PDV1127	PDV1058	PDV1085	PDV1058	PDV1085
YFM 450 Grizzly	2007	PDV1026	PDV1157	PDV1026		PDV1058	PDV1085	PDV1058	PDV1085
YFM 450 Grizzly	08-10	PDV1162	PDV1078	PDV1162	PDV1078	PDV1058	PDV1085	PDV1058	PDV1085
YFM 450 Grizzly	11-14	PDV1162	PDV1078	PDV1162	PDV1078		PDV1084		PDV1084
YFM 450 Kodiak	03-04	PDV1026	PDV1157	PDV1026					
YFM 450 Kodiak	05-06	PDV1026	PDV1157	PDV1026		PDV1058	PDV1085	PDV1058	PDV1085
YFM 450 Wolverine	06-10	PDV1026	PDV1127	PDV1026	PDV1127				
YFM 550 Grizzly	09-14	PDV1061	PDV1083	PDV1061	PDV1083	PDV1061	PDV1084	PDV1061	PDV1084
YFM 660 Grizzly	2002	PDV1026	PDV1157	PDV1026		PDV1056	PDV1079	PDV1056	PDV1080
YFM 660 Grizzly "UJ68"	2003	PDV1005	PDV1077	PDV1005	PDV1078	PDV1005	PDV1081	PDV1005	PDV1082
YFM 660 Grizzly "68LAC"	2003	PDV1014	PDV1077	PDV1014	PDV1078	PDV1005	PDV1081	PDV1005	PDV1082
YFM 660 Grizzly	04-08	PDV1014	PDV1077	PDV1014	PDV1078	PDV1014	PDV1081	PDV1014	PDV1082
YFM 700 Grizzly	07-14	PDV1061	PDV1083	PDV1061	PDV1083	PDV1061	PDV1084	PDV1061	PDV1084
YXR 660 Rhino	2004	PDV1057	PDV1078	PDV1057	PDV1077	PDV1057	PDV1082	PDV1057	PDV1081
YXR 660 Rhino	2005	PDV1060	PDV1078	PDV1060	PDV1077	PDV1060	PDV1080	PDV1060	PDV1079
YXR 660 Rhino	06-07	PDV1059	PDV1078	PCV1059	PDV1077	PDV1059	PDV1080	PCV1059	PDV1079
YXR 700 Rhino	08-13	PDV1059	PDV1083	PCV1059	PDV1083	PDV1059		PCV1059	

BRONCO Fuelles palier

Los fuelles constan de dos bridas de sujeción, grasa y el fuelle de goma.

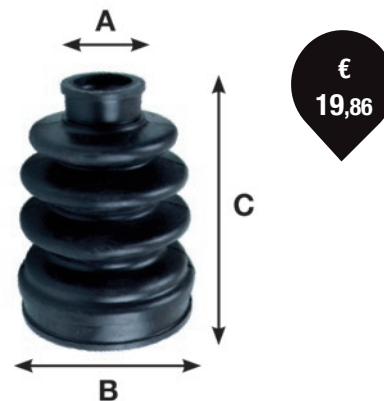

	FUELLE PALIER DELANTERO		FUELLE PALIER TRASERO		
ARCTIC CAT	Año	Interior	Exterior	Interior	Exterior
todos anterior al 2010	03-10	DAT08542	DAT08542	DAT08542	DAT08542
todos anterior al 2010	11-14	DAT08542	DAT08542	DAT08542	DAT08542
300 todos	98-05	DAT08542	DAT08542	DAT08542	DAT08542
400 todos	03-10	DAT08542	DAT08542	DAT08542	DAT08542
400 todos	11-14	DAT03086	DAT03086	DAT03086	DAT03086
450 todos	11-12	DAT03086	DAT03086	DAT03086	DAT03086
500 todos	13-14	DAT03086	DAT03086	DAT03086	DAT03086
550 todos	09-10	DAT08542	DAT08542	DAT08542	DAT08542
550 todos	11-14	DAT03086	DAT03086	DAT03086	DAT03086
650	04-10	DAT08542	DAT08542	DAT08542	DAT08542
650 Mudpro	2011	DAT03085	DAT03085	DAT03085	DAT03085
650 todos excepto Mudpro	11-12	DAT03086	DAT03086	DAT03086	DAT03086
700 todos	07-10	DAT08542	DAT08542	DAT08542	DAT08542
700 Mudpro	11-13	DAT03085	DAT03085	DAT03085	DAT03085
700 todos excepto Mudpro	11-14	DAT03086	DAT03086	DAT03086	DAT03086
1000 Wildcat	12-14	DAT03085	DAT03085	DAT03085	DAT03085
1000 Wildcat 4	13-14	DAT03085	DAT03085	DAT03085	DAT03085

	FUELLE PALIER DELANTERO		FUELLE PALIER TRASERO		
CAN AM	Año	Interior	Exterior	Interior	Exterior
330 Outlander	04-05	DAT08541	DAT085251	DAT08547	DAT08586
400 Outlander	03-05	DAT08541	DAT085251	DAT08547	DAT08586
400 Outlander	06-08	DAT08546	DAT08545	DAT08547	DAT08586
400 Outlander	09-12	DAT08546	DAT08545		
500 Outlander	2007	DAT08546	DAT08545	DAT08583	DAT08583
500 Outlander	08-12	DAT08546	DAT08545	DAT03079	DAT03079
500 Quest 4x4	02-04	DAT08541	DAT085251		
500 Renegade	2008	DAT08546	DAT08545	DAT03079	DAT03079
500 Traxter	99-05	DAT08541	DAT085251		
650 Outlander	06-07	DAT08546	DAT08545	DAT08583	DAT08583
650 Outlander	08-12	DAT08546	DAT08545	DAT03079	DAT03079
650 Quest	02-04	DAT08541	DAT085251		
650 Traxter	2005	DAT08541	DAT085251		
800 Outlander	06-12	DAT08546	DAT08545	DAT08583	DAT08583
800 Renegade	2007	DAT08546	DAT08545	DAT08583	DAT08583
800 Renegade	08-12	DAT08546	DAT08545	DAT03079	DAT03079
800 Commander	11-12	DAT08546	DAT08545	DAT03079	DAT03079
1000 Rengade	2012	DAT08546	DAT08545	DAT03079	DAT03079
1000 Outlander	2012	DAT08546	DAT08545	DAT03079	DAT03079
1000 Commander	11-12	DAT08546	DAT08545	DAT03079	DAT03079

	FUELLE PALIER DELANTERO		FUELLE PALIER TRASERO		
HONDA	Año	Interior	Exterior	Interior	Exterior
TRX 350 Rancher	00-05	DAT08593	DAT08540		
TRX 350 Rancher	2006	DAT085251	DAT08540		
TRX 400	95-01	DAT08540	DAT08540		
TRX 400	2003	DAT08593	DAT08540		
TRX 420 Rancher	07-14	DAT085251	DAT08540		
TRX 450 Foreman	98-03	DAT08593	DAT08540		
TRX 500 Foreman	05-07	DAT085251	DAT08542		
TRX 500 Foreman	08-13	DAT085251	DAT08540		
TRX 500 Rubicon	01-04	DAT08593	DAT08542		
TRX 500 Rubicon	05-07	DAT085251	DAT08542		
TRX 500 Rubicon	08-14	DAT085251	DAT08540		
TRX 650 Rincon	03-04	DAT08593	DAT08542	DAT08547	DAT08547
TRX 650 Rincon	2005	DAT085251	DAT08542	DAT08547	DAT08547
TRX 680 Rincon	06-07	DAT085251	DAT08542	DAT08547	DAT08547
TRX 680 Rincon	08-14	DAT085251	DAT08540	DAT08547	DAT08547

Referencia	A (mm)	B (mm)	C (mm)
DAT03076	23,00	68,00	110,00
DAT03077	21,00	70,25	70,40
DAT03078	25,00	78,00	95,00
DAT03079	23,00	78,50	108,00
DAT03080	20,50	75,00	93,00
DAT03081			
DAT03082			
DAT03083	20,75	63,55	97,00
DAT03085	24,00	75,00	92,50
DAT03086**	19,00	67,50	95,00
DAT03087	18,50	61,00	84,00
DAT03088	20,20	63,50	97,00
DAT03089			
DAT03090	18,50	62,00	85,00
DAT03092			
DAT08504	18,00	59,50	88,00
DAT08505	19,00	65,20	85,60
DAT08506	18,50	66,80	108,00
DAT08511*	20,50	60/70/81	85/105/130
DAT08512	18,50	58,00	89,00
DAT08521*	16,00	59/73	80/106
DAT08522	20,15	69,00	105,00
DAT08523	18,00	62,00	83,00
DAT08524			
DAT085251**	18,50	57,00	79,35
DAT08540	18,00	64,00	89,00
DAT085402**	17,50	64,00	88,00
DAT08541	25,50	80,00	94,50
DAT08542	19,50	67,00	95,00
DAT08543	22,00	78,00	98,50
DAT08544	23,00	77,00	98,50
DAT08545	19,50	68,00	101,00
DAT08546	20,00	64,00	95,00
DAT08547	19,00	64,50	92,50
DAT08583	19,00	79,00	105,20
DAT08585	19,50	66,50	102,00
DAT08586	18,50	67,50	106,50
DAT08587	20,90	72,00	107,00
DAT08593	19,00	60,00	101,50

* Modelo universal
 ** DAT085402 / DAT085251 Este fuelle se entrega con dos juegos de abrazaderas y dos paquetes de grasa

BRONCO Fuelles palier

Juego 4 bridas fuelle

€
4,94€



DAT03603

Kit fuelle universal más cono de montaje

€
23,93€



DAT03097

Tensores de brida

€
18,44€



DUP12077

€
22,37€



DMC12758

KAWASAKI	Año	FUELLE PALIER DELANTERO		FUELLE PALIER TRASERO	
		Interior	Exterior	Interior	Exterior
KLF 300 Bayou	89-04	DAT08593	DAT08540		
KVF 300 Prairie	99-02	DAT08540	DAT08540		
KVF 360 Prairie	03-05	DAT08540	DAT08540		
KVF 360 Prairie	06-08	DAT085251	DAT08540		
KVF 360 Prairie	09-13	DAT085251			
KLF 400 Bayou	93-99	DAT08593	DAT08540		
KVF 400 Prairie	98-02	DAT08540	DAT08540		
KVF 650 Brute Force	04-09	DAT085251	DAT08540		
KVF 650 Brute Force	10-13	DAT085251			
KVF 650i Brute Force	06-08	DAT085251	DAT08542	DAT08547	DAT08542
KVF 650i Brute Force	09-13	DAT085251	DAT08545	DAT03076	DAT03076
KVF 650 Prairie	02-03	DAT08540	DAT08540		
KVF 700 Prairie	04-06	DAT085251	DAT08540		
KVF 750i Brute Force	05-07	DAT085251	DAT08542	DAT08547	DAT08542
KVF 750i Brute Force	08-11	DAT08546	DAT08545	DAT08542	DAT03076
KVF 750i Brute Force	12-15	DAT085251	DAT08545	DAT08542	DAT03076
KRT 750 Teryx	08-09			DAT03078	DAT03077
KRT 750 Teryx	10-11	DAT085251	DAT03076	DAT03078	DAT03077
KRT 750 Teryx	12-13	DAT085251	DAT03076		
750 Teryx	2009	DAT08525			
2510 Mule	00-02	DAT08593	DAT08540		
3010 Mule	01-08	DAT08593	DAT08540		
4010 Mule	09-15	DAT085251			

POLARIS	Año	FUELLE PALIER DELANTERO		FUELLE PALIER TRASERO	
		Interior	Exterior	Interior	Exterior
250 Xplorer	00-02	-	DAT08587	-	-
300 Hawkeye	06-07	DAT08540	DAT08540	DAT08540	DAT08540
300 Sportsman	08-10	DAT08540	DAT08540	DAT08540	DAT08540
300 Xplorer	96-99	-	DAT08586	-	-
300 Xplorer	00-02	-	DAT08587	-	-
325 Magnum	00-02	-	DAT08586	-	-
325 Ranger	2015	DAT08585	DAT08585		
325 Sportsman ACE	2015			DAT08583	DAT08583
325 Xpedition	00-02	-	DAT08586	-	-
330 Magnum HDS	03-04		DAT08586	-	-
330 Magnum excluido HDS	03-04		DAT08587	-	-
330 Magnum	05-06	DAT08585	DAT08587	-	-
400 Ranger	10-15	DAT08585	DAT08585	DAT08583	DAT08583
400 Scrambler	95-96	-	DAT08586	-	-
400 Scrambler	97-98	-	DAT08587	-	-
400 Scrambler	1999	-	DAT08586	-	-
400 Scrambler	00-02	-	DAT08587	-	-
400 Sportsman	2001	-	DAT08586	DAT08544	DAT08543
400 Sportsman	2002	-	DAT08587	DAT08544	DAT08543
400 Sportsman	03-04	-	DAT08587	DAT08544	DAT08541
400 Sportsman	2005	DAT08585	DAT08587	DAT08544	DAT08541
400 Sportsman	13-14	DAT03083	DAT03080	DAT03083	DAT03080
400 Sportsman HO	08-10	DAT08540	DAT08540	DAT08540	DAT08540
400 Sportsman HO	11-12	DAT03083	DAT03080	DAT03083	DAT03080
400 Xplorer	97-98	-	DAT08586	-	-
400 Xplorer	99-02	-	DAT08587	-	-
425 Xpedition	00-01	-	DAT08586	-	-
425 Xpedition	2002	-	DAT08587	-	-
450 Sportsman	06-07	DAT08546	DAT08545	DAT08583	DAT08583
500 Magnum	99-02	-	DAT08586	-	-
500 Scrambler	97-98	-	DAT08586	-	-
500 Scrambler	99-09	-	DAT08587	-	-
500 Scrambler	2010	DAT08546	DAT08545	-	-
500 Sportsman	1997	-	DAT08587	-	-
500 Sportsman	98-01	-	DAT08586	DAT08544	DAT08543
500 Sportsman EFI antes 25/07/06	06-07	DAT08547	DAT08586	DAT08583	DAT08583

RUEDAS Y NEUMÁTICOS

MOTOR

ADMISIÓN / ESCAPE REFRIGERACIÓN

ELÉCTRICO

SUSPENSIÓN / DIRECCIÓN

FRENOS

TRANSMISIÓN

CONTROLES Y MANDOS

CHASIS

ACCESORIOS

BRONCO Fuelles palier

500 Sportsman EFI	2006	DAT08546	DAT08545	DAT08583	DAT08583
500 Sportsman EFI	08-09	DAT08546	DAT08545	DAT03079	DAT03079
500 Sportsman HO	2001		DAT08586	DAT08544	DAT08543
500 Sportsman HO	2002		DAT08587	DAT08544	DAT08543
500 Sportsman HO	03-04		DAT08587	DAT08544	DAT08541
500 Sportsman HO	2005	DAT08585	DAT08587	DAT08544	DAT08541
500 Sportsman HO	2006	DAT08547	DAT08586	DAT08583	DAT08583
500 Sportsman HO	08-10	DAT08546	DAT08545	DAT03079	DAT03079
500 Sportsman HO	11-12	DAT03083	DAT03080	DAT03083	DAT03080
500 Sportsman HO	2013	DAT03082	DAT03082	DAT03083	DAT03080
500 Sportsman X2	2006	DAT08547	DAT08586	DAT08583	DAT08583
500 Sportsman X2 desde 25/07/06	06-07	DAT08546	DAT08545	DAT08583	DAT08583
500 Sportsman X2	08-09	DAT08546	DAT08545	DAT03079	DAT03079
550 Sportsman Touring	2010	DAT08546	DAT08545	DAT03081	DAT03081
550 Sportsman Touring	2011	DAT03083	DAT03082	DAT03081	DAT03081
550 Sportsman Touring EPS	10-11			DAT03081	DAT03081
550 Sportsman Touring EPS	12-14	DAT03083	DAT03082	DAT03081	DAT03081
550 Sportsman X2	2010	DAT08546	DAT08545	DAT03081	DAT03081
550 Sportsman X2	11-12	DAT03083	DAT03082	DAT03081	DAT03081
550 Sportsman X2	2013	DAT03083	DAT03082		
550 Sportsman XP	2009	DAT08546	DAT08545	DAT03079	DAT03079
550 Sportsman XP	2010			DAT03081	DAT03081
550 Sportsman XP	11-13	DAT03083	DAT03082	DAT03081	DAT03081
550 Sportsman XP EPS	2010	DAT08546	DAT08545	DAT03081	DAT03081
550 Sportsman XP EPS	11-13	DAT03083	DAT03082	DAT03081	DAT03081
570 Sportsman ACE	2015			DAT08583	DAT08583
600 Sportsman	03-05	-	DAT08587		
700 Ranger	2005	DAT08547	DAT08586	DAT08583	DAT08583
700 Ranger	06-07	DAT08585	DAT08587	DAT08583	DAT08583
700 Ranger	2008	DAT08585	DAT08585	DAT03079	DAT03079
700 Ranger	2009	DAT08546	DAT08545	DAT03079	DAT03079
700 Ranger Crew	08-09	DAT08585	DAT08585	DAT03079	DAT03079
700 Sportsman	02-04	-	DAT08587	DAT08544	DAT08541
700 Sportsman	2005	DAT08585	DAT08587	DAT08544	DAT08541
700 Sportsman antes 25/07/06	2006	DAT08547	DAT08586	DAT08583	DAT08583
700 Sportsman desde 25/07/06	06-07	DAT08546	DAT08545	DAT08583	DAT08583
700 Sportsman	2008	DAT08546	DAT08545	DAT03079	DAT03079
800 Ranger	2010	DAT08546	DAT08545	DAT03079	DAT03079
800 Ranger	11-14	DAT03081	DAT03081	DAT03083	DAT03080
800 RZR	08-10	DAT08585	DAT08585	DAT08545	DAT08545
800 RZR	11-14	DAT08585	DAT08585	DAT03083	DAT03080
800 RZR S	09-10	DAT08585	DAT08585	DAT03079	DAT03079
800 RZR S	11-14	DAT08585	DAT08585	DAT03083	DAT03080
800 RZR 4	2010	DAT08585	DAT08585	DAT03079	DAT03079
800 RZR 4	11-14	DAT08585	DAT08585	DAT03083	DAT03080
800 Sportsman	2005	DAT08585	DAT08587	DAT08583	DAT08541
800 Sportsman Neapco	2006	DAT08585	DAT08587	DAT08583	DAT08583
800 Sportsman GKN	2006	DAT08547	DAT08586	DAT08583	DAT08583
800 Sportsman desde 25/07/06	06-07	DAT08546	DAT08545	DAT08583	DAT08583
800 Sportsman	08-10	DAT08546	DAT08545	DAT03079	DAT03079
800 Sportsman	11-12	DAT03083	DAT03080	DAT03083	DAT03080
800 Sportsman	13-14	DAT03082	DAT03082	DAT03083	DAT03080
850 Scrambler	13-15	DAT03083	DAT03082	DAT03081	DAT03081
850 Scrambler					
850 Sportsman Touring	2010	DAT08546	DAT08545	DAT03081	DAT03081
850 Sportsman Touring	11-13	DAT03083	DAT03082	DAT03081	DAT03081
850 Sportsman XP	09-10	DAT08546	DAT08545	DAT03079	DAT03079
850 Sportsman XP	12-13	DAT03083	DAT03082	DAT03081	DAT03081
900 Ranger XP	2013			DAT03083	DAT03080
900 Ranger Diesel	11-14	DAT03081	DAT03081	DAT03083	DAT03080
900 RZR	11-14	DAT03083	DAT03080	DAT03083	DAT03080
900 RZR	2015	DAT08585	DAT08585		
1000 RZR	2015	DAT08585	DAT08585		



DAT08504

DAT08505



DAT08506

DAT08511



DAT08512

DAT08521



DAT08522

DAT08523



DAT08525

DAT08540



DAT08541

DAT08542



DAT08543

DAT08544

BRONCO Fuelles palier

SUZUKI	Año	FUELLE PALIER DELANTERO		FUELLE PALIER TRASERO	
		Interior	Exterior	Interior	Exterior
LT-F 300 King Quad	96-98	DAT08547	DAT08541		
LT-F 300 King Quad	99-02		DAT08541		
LT 300 Quad Runner	94-95	DAT08547	DAT08541		
LT-A 400 Eiger	03-04	DAT085251	DAT085251		
LT-F 400 Eiger	05-07	DAT085251	DAT08541		
LT-A 450 King Quad	07-10	DAT03090	DAT085402		
LT-A 500 King Quad	2009	DAT03087	DAT03088		
LT-A 500 King Quad	11-12	DAT03090	DAT03088		
LT-A 500 King Quad PS	2009	DAT03087	DAT03088		
LT-A 500 King Quad PS	11-12	DAT03090	DAT03088		
LT-A 500 Quad Runner	98-01		DAT08541		
LT-A 500 Vinson	2002		DAT08541		
LT-A 500 Vinson	03-05	DAT085251	DAT085251		
LT-A 500 Vinson	2006	DAT085251	DAT08541		
LT-A 550 King Quad	2012	DAT03090	DAT085402		
LT-A 700 King Quad	05-07	DAT08547	DAT08547	DAT08547	DAT08547
LT-V 700 Twin Peaks	04-05	DAT085251	DAT08541		
LT-A 750 King Quad	08-12	DAT03090	DAT085402		
LT-A 750 King Quad PS	2009	DAT03087	DAT03088		
LT-A 750 King Quad PS	11-12	DAT03090	DAT03088		

YAMAHA	Año	FUELLE PALIER DELANTERO		FUELLE PALIER TRASERO	
		Interior	Exterior	Interior	Exterior
YFM 250 Timberwolf	94-00	DAT08593	DAT08540		
YFM 350 Big Bear	87-96	DAT08593	DAT08540		
YFM 350 Big Bear	97-99	DAT08540	DAT08540		
YFM 350 Bruin	04-06	DAT08593	DAT08540		
YFM 350 Grizzly	07-11	DAT08593	DAT08540		
YFM 350 Grizzly	12-14	DAT085251	DAT08540		
YFM 350 Grizzly IRS	07-11	DAT085251	DAT08540	DAT08540	DAT08504

YFM 350 Grizzly IRS	2012	DAT085251	DAT08540		
YFM 350 Wolverine	95-05	DAT08540	DAT08540		
YFM 400 Big Bear	00-01	DAT08540	DAT08540		
YFM 400 Big Bear	02-06	DAT08593	DAT08540		
YFM 400 Big Bear	07-12	DAT085251	DAT08540	DAT08540	DAT08504
YFM 400 Grizzly	07-08	DAT08593	DAT08540	DAT08540	DAT08504
YFM 400 Kodiak semi.	93-04	DAT08593	DAT08540		
YFM 400 Kodiak	05-06	DAT08593	DAT08540	DAT08540	DAT08504
YFM 450 Grizzly	2007	DAT08540	DAT08540	DAT08540	DAT08504
YFM 450 Grizzly	08-14	DAT085251	DAT08540	DAT08540	DAT08504
YFM 450 Kodiak	03-04	DAT08540	DAT08540		
YFM 450 Kodiak	05-06	DAT08540	DAT08540	DAT08540	DAT08504
YFM 450 Wolverine	06-08	DAT08593	DAT08540		
YXR 450 Rhino	06-09	DAT085251	DAT08542	DAT08540	DAT08542
YFM 550 Grizzly	09-11	DAT08593	DAT08547	DAT08593	DAT08547
YFM 550 Grizzly	2012	DAT08593	DAT08547		
YFM 600 Grizzly	98-01	DAT08540	DAT08540		
YFM 660 Grizzly	2002	DAT08540	DAT08540	DAT08540	DAT08504
YFM 660 Grizzly	2003	DAT085251	DAT08540	DAT08540	DAT08504
YFM 660 Grizzly	04-08	DAT085251	DAT08540	DAT08540	DAT08504
YXR 660 Rhino	2004	DAT08540	DAT08540	DAT08540	DAT08504
YXR 660 Rhino	05-07	DAT085251	DAT08542	DAT08540	DAT08542
YFM 700 Grizzly	07-11	DAT08593	DAT08545	DAT08593	DAT08547
YFM 700 Grizzly	2012	DAT08593	DAT08545	DAT08593	
YXR 700 Rhino	08-09	DAT08540	DAT08542	DAT08540	DAT08542
YXR 700 Rhino	11-13	DAT08540		DAT08540	DAT08542

BRONCO Soporte cardan



€
47,22€

CAN AM	Año	Referencia
1000 Commander Max	14-17	DAT08953
1000 Maverick Max	15-17	DAT08953

POLARIS	Año	Referencia
570 Ranger	14-16	DAT08952
900 Ranger	14-16	DAT08952
900 RZR	12-14	DAT08953
900 RZR	15-16	DAT08952
900 RZR "4"	12-14	DAT08953
900 RZR "4"	15-16	DAT08952
1000 Ranger Diesel	15-16	DAT08952
1000 RZR XP	2014	DAT08953
1000 RZR XP	15-16	DAT08952
1000 RZR XP "4"	14-15	DAT08952
1000 RZR XP Turbo	16-17	DAT08953
1000 RZR XP Turbo "4"	16-17	DAT08953
1000 General	16-17	DAT08953

Sustituye a:

Referencia	Referencia Original
DAT08952	
DAT08953	3514748 / 705401498 / 705401646



Cardan completo



CAN AM	FRONTAL			TRASERO	
	Año	Referencia	€	Referencia	€
450 Outlander	2015	PDC8020		PDC8021	
450 Outlander MAX	2015	PDC8020		PDC8022	
500 Outlander	13-15			PDC8008	496,02
500 Outlander MAX	13-15			PDC8009	496,02
500 Renegade	2008			PDC8023	
500 Renegade	13-15			PDC8008	496,02
650 Outlander	13-15			PDC8008	496,02
650 Outlander MAX	13-15			PDC8009	496,02
800 Outlander	2008			PDC8023	
800 Outlander	13-15			PDC8008	496,02
800 Outlander MAX	06-11			PDC8024	
800 Outlander MAX	13-15			PDC8009	496,02
800 Renegade	2008			PDC8023	
800 Renegade	13-15			PDC8008	496,02
1000 Maverick	13-14	PDC8012	418,82	PDC8017	
1000 Maverick	2015	PDC8012	418,82		
1000 Outlander	13-14			PDC8006	496,02
1000 Outlander	2015			PDC8008	496,02
1000 Outlander XMR	13-14			PDC8013	496,02
1000 Outlander MAX	13-14			PDC8007	551,38
1000 Outlander XMR	2015			PDC8009	496,02
1000 Renegade	13-14			PDC8006	496,02
1000 Renegade	2015			PDC8008	496,02

POLARIS	FRONTAL			TRASERO	
	Año	Referencia	€	Referencia	€
Sportsman ACE	14-15	PDC1011			
RZR 800	11-14	PDC1001	615,30		
RZR 800 S	11-14	PDC1001	615,30		
Ranger 900 CREW	14-15	PDC1005	660,49	PDC1006	1044,04
Ranger 900 XP	13-15	PDC1003	658,31		
RZR 900	11-14	PDC1022			
RZR 900	2015	PDC1014		PDC1015	
RZR 900 "4"	12-14	PDC1023			
RZR 900 "4"	2015	PDC1012		PDC1015	
RZR 900 "4"	2016	PDC1012			
RZR 1000 XP	15-16			PDC1013	
RZR 1000 XP 4	14-16	PDC1012		PDC1013	

YAMAHA	FRONTAL			TRASERO	
	Año	Referencia	€	Referencia	€
YFM 660 Grizzly	02-08	PDC6001	364,00		



€ 18



Kit retenes grupo diferencial

CAN AM	Año	Referencia delantera	Referencia trasera
Outlander 330	04-05	DAT03588	DAT03588
Outlander 400	03-05	DAT03588	DAT03588
Outlander 400	06-11	DAT03588	DAT03589
Outlander 400	2012	DAT03588	DAT03590
Outlander 500	07-11	DAT03588	DAT03589
Outlander 500	2012	DAT03588	DAT03590
Outlander 500	13-14	DAT03588	
Renegade 500	08-11	DAT03588	DAT03589
Renegade 500	12-13	DAT03588	DAT03590
Renegade 500	2014	DAT03588	
Traxter 500	99-05	DAT03588	
Outlander 650	06-11	DAT03588	DAT03589
Outlander 650	12-13	DAT03588	DAT03590
Outlander 650	2014	DAT03588	
Quest 650	02-04	DAT03588	
Traxter 650	04-05	DAT03588	
Commander 800	11-13	DAT03588	DAT03590
Outlander 800	06-11	DAT03588	DAT03589
Outlander 800	2013	DAT03588	DAT03590
Outlander 800	12-14	DAT03588	
Outlander 800 XMR/MAX	11-12	DAT03588	DAT03590
Renegade 800	07-11	DAT03588	DAT03589
Renegade 800	12-13	DAT03588	DAT03590
Renegade 800	2014	DAT03588	
Commander 1000	11-13	DAT03588	DAT03590
Maverick 1000	2013	DAT03588	
Outlander 1000	13-14	DAT03588	DAT03590
Outlander STD XT 1000	12-14	DAT03588	DAT03590
Outlander STD XT 1000	2014	DAT03588	
Renegade 1000	12-13	DAT03588	DAT03590
Renegade 1000	2014	DAT03588	

HONDA	Año	Referencia delantera	Referencia trasera
TRX 500 Foreman	04-14	DAT03591	DAT03592
TRX 650 Rincon	03-05	DAT03591	DAT03593
TRX 680 Rincon	06-14	DAT03591	DAT03593

KAWASAKI	Año	Referencia delantera	Referencia trasera
KVF 360 Prairie	03-13	DAT03585	
KVF 650 Prairie	02-03	DAT03585	DAT03586
KV F650 Brute force	05-13	DAT03585	DAT03586
KVF 650i Brute force	06-13	DAT03585	DAT03587
KVF 700 Prairie	04-06	DAT03585	DAT03586
KFX 700 V-Force	04-06		DAT03586
KVF 750 Brute Force	05-14	DAT03585	DAT03587
KVF 750 Brute Force EPS	12-14	DAT03585	DAT03587

SUZUKI	Año	Referencia delantera	Referencia trasera
LT-V 700F Twin Peaks	04-06	DAT03585	DAT03586

YAMAHA	Año	Referencia delantera	Referencia trasera
YFM 350 Grizzly IRS	07-11	DAT03582	
YFM 400 Big Bear IRS	07-12	DAT03582	
YFM 450 Kodiak	03-06	DAT03582	
YFM 450 Grizzly	07-14	DAT03582	
YFM 550 Grizzly	09-14	DAT03582	DAT03584
YFM 600 Grizzly	2002	DAT03582	DAT03583
YFM 660 Grizzly	02-08	DAT03582	DAT03583
YFM 700 Grizzly	07-14	DAT03582	DAT03584

CONTROLES Y MANDOS



EMGO Paramanos

Para proteger las manos de las piedras o del frío.
Fáciles de montar. La brida de sujeción al manillar es de \varnothing 22mm.

Referencia	Descripción	€
E79-97937	Paramanos Azul Yamaha	23,96
E79-97931	Paramanos Rojo Honda	23,96
E79-97934	Paramanos Negro	23,96
E79-97936	Paramanos Transparente	23,96
E79-97930	Paramanos Blanco	23,96
E79-97935	Paramanos Carbono	26,81
E79-97939	* Recambio anclajes	9,90

* Los pilotos que sustituyan el manillar y no deseen perder los protectores de manos, disponen de los soportes interiores del manillar como recambio.



PSYCHIC Paramanos

Referencia	Descripción	€
DMX12027BU	Paramanos Azul Yamaha	28,21
DMX12027RD	Paramanos Rojo Honda	28,21
DMX12027BK	Paramanos Negro	28,21
DMX12027YL	Paramanos Amarillo	28,21
DMX12027WI	Paramanos Blanco	28,21
DMX12027GN	Paramanos Verde	28,21



XPEED Manillares

Manillares de hierro y aluminio.
Manillares de diámetro 22 y de diámetro variable.
Manillares color aluminio y de colores.

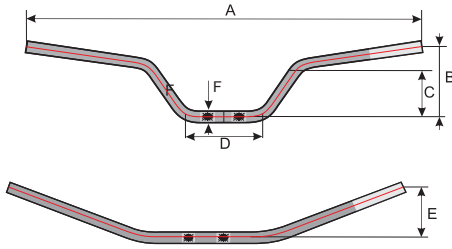

Referencia	Descripción	Imagen	A	B	C	D	E	F	€
RY010A	Aluminio. Xpeed	A	773	110	87	175	97	22	38,19
RY010B	Aluminio. Xpeed	B	773	110	87	175	97	28,6	40,44
RY030B	Aluminio. Xpeed	B	785	140	105	155	100	28,6	40,44
RS010A	Aluminio. Xpeed	A	790	142	105	200	90	22	38,19
RS010B	Aluminio. Xpeed	B	790	142	105	200	90	28,6	40,44

Accesorios manillares



Referencia	Descripción	€
E99-96800	Protector varilla manillar	4,32



Referencia	Descripción	€
RY100A	Varilla manillar Ø 22 Xpeed	13,80

EMIGO Elevadores manillar

Eleva el manillar económicamente y sin trabajo, si eres alto podrás conducir más cómodamente y sin doblar tan pronunciadamente la espalda.

Fabricados con aluminio AL 6061

Referencia	Descripción	Color	€
DMX081101	de Ø 22 mm a 22 mm, 2 cm mas alto	aluminio	31,14
DMX081681	de Ø 22 mm a 22 mm, 2 cm mas alto	negro	33,38
DMX08171	de Ø 22 mm a 22 mm, 2 a 4 cm mas alto	aluminio	41,95
DMX08110	de Ø 22 mm a 28,6 mm, 2 cm mas alto	aluminio	31,14
DMX08110BK	de Ø 22 mm a 28,6 mm, 2 cm mas alto	negro	31,14
DMX08110BU	de Ø 22 mm a 28,6 mm, 2 cm mas alto	azul	31,14
DMX08110OR	de Ø 22 mm a 28,6 mm, 2 cm mas alto	naranja	31,14
DMX08168	de Ø 22 mm a 28,6 mm, 2 cm mas alto	negro	33,38
E23-08191	de Ø 22 mm a 28,6 mm, 2 cm mas alto	aluminio	45,12
DMX081711	de Ø 28,6 mm a 28,6 mm, 2 a 4 cm mas alto	aluminio	44,76
DMX08151	Elevador manillar moto Ø 28,6 mm	aluminio	36,12

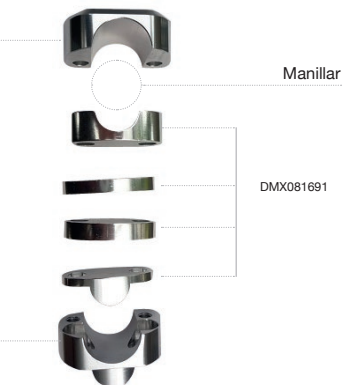

XPEED Desconectores

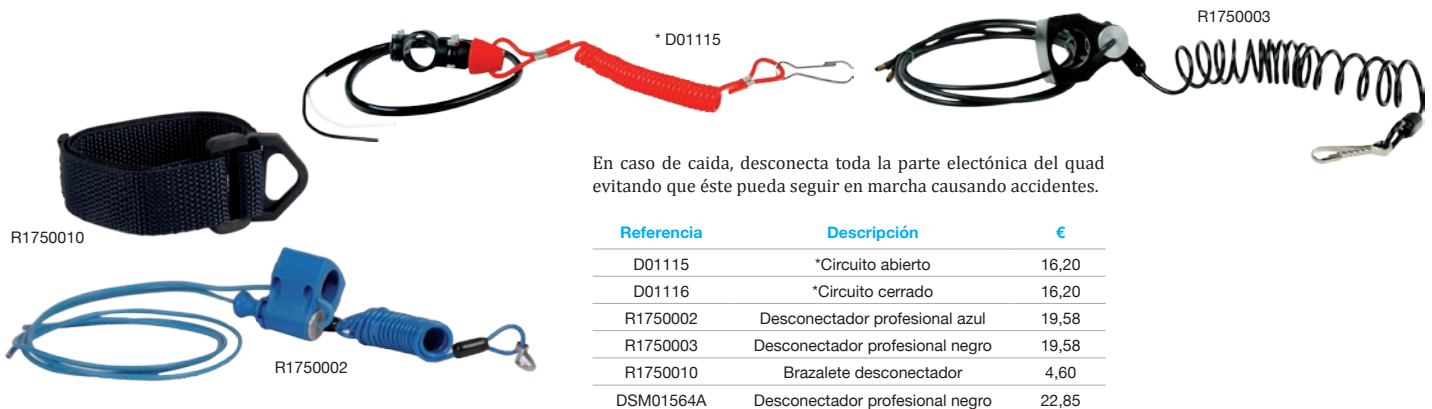

R1750010

* D01115

R1750003

R1750002

DSM01564A

En caso de caída, desconecta toda la parte electrónica del quad evitando que éste pueda seguir en marcha causando accidentes.

Referencia	Descripción	€
D01115	*Circuito abierto	16,20
D01116	*Circuito cerrado	16,20
R1750002	Desconector profesional azul	19,58
R1750003	Desconector profesional negro	19,58
R1750010	Brazalete desconector	4,60
DSM01564A	Desconector profesional negro	22,85



Kit reparación cable embrague/acelerador

El kit lo compone un cable de 1,5mm de diámetro y 2m de largo, un cable de 1,2mm de diámetro y 2m de largo, más siete piezas diferentes de terminación.

Referencia	€
DMP05092	5,28

XPEED Desmultiplicador embrague

Referencia	€
DAT05700	23,22



XPEED Calefacción de manos y gatillo

€
19,60

DAT12750
Calefacción gatillo



€
30,73

Ofrece una temperatura de confort en las manos. Dispone de dos intensidades. Fácil montaje. Se puede servir con dos modelos de interruptor.



D12170A

D12170B

€
6,90

D1216604
1 Interruptor de recambio



EMIGO Aceleradores de puño estándar



D101053



D101054



D101057

	Giro	Referencia	€
TIPO CR PRO	170° 1/2	D101053	15,64
TIPO VORTEX	95° 1/4	D101054	24,05
TIPO TURBO	150° 1/3	D101057	16,59
TIPO AGRICOLA		D101063	



D101063

Especial para agricultura. Se puede limitar la velocidad hasta 7km/h con el tornillo de control.

XPEED Acelerador de gatillo

Referencia	Descripción	€
DAT08404	Honda Deportivos	33,82
DAT08406	Yamaha Blaster / Banshee	29,77
DAT08407	Deportivos Yamaha	33,82



DAT08404



DAT08406



DAT08407

XPEED Empuñaduras



DMX08003



R520050



R520090



R520113



R520110
R520111



R520120
R520121



R520122



R520150
R520153



R520160



R520170
R520171

Referencia	Descripción	€
R520050	Puños de goma Grises 22 - 22	7,36
R520090	Puños de goma Grises 22 - 22	7,36
R520110	Puños de goma Grises 22 - 22	7,36
R520111	Puños de goma Grises 22 - 24	7,36
R520113	Puños de goma Negros 22 - 24	7,36
R520120	Puños de goma Grises 22 - 22	7,36
R520121	Puños de goma Grises 22 - 24	7,36

Referencia	Descripción	€
R520122	Puños de goma Negros 22 - 22	7,36
R520150	Puños de goma Negros 22 - 22	7,36
R520153	Puños de goma Negros 22 - 24	7,36
R520160	Puños de goma Grises 22 - 22	7,36
R520170	Puños de goma Azules 22 - 22	7,36
R520171	Puños de goma Azules 22 - 24	7,36
DMX08003	Puños de goma Negros 22 - 24	5,44



€ Según color de referencia

€
13,95

€
15,40

€
17,10

4PLAY Cables acelerador y embrague

Cables 5 cm más largos

	Año	Referencia	ACELERADOR DE GATILLO	ACELERADORES DE PUÑO		CABLE EMBRAGUE
				TIPO CR PRO	TIPO VORTEX	
CAN AM						
Outlander 330	03-05			D1011032		
Outlander 400	04-07			D1011032		
Outlander 500	2007			D1011031		
Outlander 650	2007			D1011031		
Outlander 800	06-07			D1011031		

	Año	Referencia	ACELERADOR DE GATILLO	ACELERADORES DE PUÑO		CABLE EMBRAGUE
				TIPO CR PRO	TIPO VORTEX	
HONDA						
TRX 250 Sportrax	97-15	D102202				
TRX 250 Rincon	02-04	D102202				
TRX 250 Sportrax	06-12	D102546				
TRX 300 EX	93-06	D102135		D101220		D102108
TRX 300 EX	07-08	D102135		D101220		D102108
TRX 350 Rancher	00-06	D102375				
TRX 400 Rancher	95-07	D102375				
TRX 400 EX Sportrax	99-04	D102517		D101707		D102382
TRX 400 EX Sportrax	05-07	D102517				D102518
TRX 400 EX Sportrax	08-12	D102517				D102548
TRX 420 Rancher	07-11	D102375				
TRX 450 R Sportrax	04-09	D102408			D1011013	D102405
TRX 650 Rincon	03-05	D102375		D101609		
TRX 680 Rincon	06-12	D102375		D101609		
TRX 700 X	08-09	D102568				D102572

	Año	Referencia	ACELERADOR DE GATILLO	ACELERADORES DE PUÑO		CABLE EMBRAGUE
				TIPO CR PRO	TIPO VORTEX	
KAWASAKI						
KFX 400	03-06	D104228		D101459	D101458	D104232
KFX 450 R	08-12	D103376				D103374
KVF 650 Brute Force	02-13	D103350				
KSV 700 V-Force	04-09	D103350				
KVF 700	04-06	D103350				
KVF 750i Brute Force	05-07	D103362				
KVF 750i Brute Force	08-12	D103379				

	Año	Referencia	ACELERADOR DE GATILLO	ACELERADORES DE PUÑO		CABLE EMBRAGUE
				TIPO CR PRO	TIPO VORTEX	
POLARIS						
300 Hawkeye	06-11	D110090				
325 Magnum	01-02	D110090				
325 Trail Boss	02-03	D110090				
325 Expedition	2002	D110090				
330 Trail Boss	03-07	D110090				
400 Sportsman	01-12	D110090				
450 Expedition	00-02	D110090				
450 Sportsman	06-07	D110090				
500 Predator Troy	03-07	D110090				DAT05308
500 Magnum	01-03	D110090				
500 Scrambler	99-11	D110090				
500 Outlaw	06-07	D110090				DAT05308
500 Sportsman/RSE/HO	99-12	D110090				
500 Sportsman EFI	06-07	D110118				
525 Outlaw	07-08	D110120				
600 Sportsman Twin	03-05	D110090				
700 Sportsman Twin	02-06	D110090				
700 Sportsman Twin	04-07			D110107		
800 Sportsman Twin	05-15			D110107		



€ Según color de referencia

€
13,95

€
15,40

€
17,10

4PLAY Cables acelerador y embrague

Cables 5 cm más largos

	ACELERADOR DE GATILLO	ACELERADORES DE PUÑO		CABLE EMBRAGUE	
		TIPO CR PRO	TIPO VORTEX		
SUZUKI					
	Año	Referencia	Referencia	Referencia	Referencia
160 LT-F Quadrunner	91-01	D104118			
250 LT-F Ozark	01-05	D104215			
400 LT-A Eiger	02-04	D104249			
400 LT-A Eiger	2007	D104248			
400 LT-F Eiger	02-06	D104249			
400 LT-Z QuadSport	03-08	D104228	D101459	D101458	D104232
400 LT-Z QuadSport	09-12	D104302			D104232
450 LT-R QuadSport	06-09	D104258			D104262
450 LT-A King Quad	07-09	D104248			
700 LTV Twin Peaks	2005	D103350			
700 LT-A King Quad	05-07	D104248			
750 LT-A King Quad	08-09	D104248			
	ACELERADOR DE GATILLO	ACELERADORES DE PUÑO		CABLE EMBRAGUE	
	Año	Referencia	Referencia	Referencia	Referencia
YAMAHA					
125 Breeze	89-04	D105171			
200 Blaster	88-06	D105118			D105119
250 Big Bear	07-09	D105349			
250 Raptor	08-12	D105363			
350 Warrior	93-04	D105153			D105092
350 Raptor	04-12	D105327		D1011015	D105328
350 Banshee	87-06	D105136			D105111
350 Wolverine	06-09	D105282			
350 Bruin	05-06	D105282			
400 Big Bear	00-12	D105349			
400 Kodiak Ultrama	00-06	D105282			
450 YFZ	04-12	D105315	D101473	D101472	D105304
450 YFZ-R	09-12	D105383	D1011135		D105387
450 Grizzly	07-11	D105282			
450 Wolverine	06-10	D105282			
550 Grizzly	09-12	D105352			
660 Raptor	01-05	D105241			D105271
660 Grizzly	02-08	D105284			
700 Raptor	06-12	D105337	D1011030		D105338
700 Grizzly	07-12	D105352			



RUEDAS Y NEUMÁTICOS

MOTOR

ADMISIÓN / ESCAPE REFRIGERACIÓN

ELECTRICO

SUSPENSIÓN / DIRECCIÓN

FRENOS

TRANSMISIÓN

CONTROLES Y MANDOS

CHASIS

ACCESORIOS

BRONCO Manetas de embrague y freno



DAT08069SL



DAT08180

HONDA	Año	EMBRAGUE		FRENO	
		Referencia	€	Referencia	€
TRX 250 Recon	97-01	DAT08165	6,44	DAT08108*	6,93
TRX 250 EX Sportrax	01-05	DAT08152SL	10,73	DAT08173	5,94
TRX 250 EX Sportrax	06-16	DAT08165	6,44	DAT08173	5,94
TRX 250 Recon	02-13	DAT08152	12,05	DAT08107	6,44
TRX 300 Fourtrax	88-00	DAT08152	12,05	DAT08108*	6,93
TRX 300 EX Sportrax	93-06	DAT08166	10,07	DAT08173	5,94
TRX 300 EX Sportrax	07-08	DAT08165	6,44	DAT08173	5,94
TRX 350 Rancher	00-03	DAT08152	12,05	DAT08184	
TRX 350 Rancher	04-06	DAT08152	12,05	DAT08108*	6,93
TRX 400 Foreman	95-03	DAT08152	12,05	DAT08108*	6,93
TRX 400 Rancher	04-07	DAT08167	9,24	DAT08154	9,24
TRX 400 EX Sportrax	08-14	DAT08165	6,44	DAT08173	5,94
TRX 420 Rancher	07-14	DAT08152	12,05	DAT08154	9,24
TRX 450 Rancher	98-04	DAT08152	12,05	DAT08108*	6,93
TRX 450 R	04-14	DAT08165	6,44	DAT08174	13,04
TRX 500 Rubicon	05-14	DAT08168	14,19	DAT08154	9,24
TRX 650 Rincon	03-05	DAT08167	9,24	DAT08154	9,24
TRX 680 Rincon	06-16	DAT08167	9,24	DAT08154	9,24
TRX 700 XX	08-09	DAT08165	6,44	DAT08175	7,92

KAWASAKI	Año	EMBRAGUE		FRENO	
		Referencia	€	Referencia	€
KLF 220 Bayou	88-96	DAT08086	6,11		
KSF 250 Mojave	89-04	DAT08086	6,11	DAT08085	5,94
KEF 300 Lakota	95-99	DAT08169	7,92	DAT08085	5,94
KLF 300 Bayou	91-02	DAT08169	7,92	DAT08085	5,94
KVF 300 Prairie	1999	DAT08169	7,92	DAT08085	5,94
KVF 360 Prairie	03-12	DAT08171	7,59	DAT08176	6,44
KLF 400 Bayou	93-99	DAT08169	7,92	DAT08085	5,94
KVF 400 Prairie	97-02	DAT08169	7,92	DAT08085	5,94
KVF 650 Bute Force	02-03	DAT08171	7,59	DAT08176	6,44
KVF 650 Bute Force	03-13	DAT08171	7,59	DAT08176	6,44
KFX 700 V-Force	04-09	DAT08170	8,42	DAT08176	6,44
KVF 750 Bute Force	05-16	DAT08171	7,59	DAT08176	6,44

KTM	Año	EMBRAGUE		FRENO	
		Referencia	€	Referencia	€
450 SX	09-12	DMX08457	21,30	DAT08155	24,68
450 SX-F	09-13			DAT08155	24,68
450 XC	2009	DMX08457	21,30	DAT08155	24,68
505 SX	09-10	DMX08457	21,30	DAT08155	24,68
525 XC	2009	DMX08457	21,30	DAT08155	24,68

SUZUKI	Año	EMBRAGUE		FRENO	
		Referencia	€	Referencia	€
LT-F 160 Quadruner	91-04			DAT08084	8,58
LT-F 250 Quadruner	88-02	DAT08082	6,93	DAT08065	7,59
LT-F 300 King Quad	99-02	DAT08082	6,93	DAT08065	7,59
LT-Z 400 Quadsport	03-08	DAT08068SL	6,44	DAT08153	6,44
LT-Z 400 Quadsport	09-14	DAT08158	6,44	DAT08157	16,34
LT-A 500 Quadruner	00-01	DAT08082	6,93	DAT08065	7,59
LT-F 500 Quadruner	98-02	DAT08082	6,93	DAT08065	7,59

YAMAHA	Año	EMBRAGUE		FRENO	
		Referencia	€	Referencia	€
YFA 125 Breeze	89-01	DAT08067	6,93	DAT08075	6,93
YFA 125 Breeze	02-03	DAT08069SL	6,11	DAT08076	6,11
YFM 125 Grizzly	04-13	DAT08069SL	6,11	DAT08076	6,11
YFS 200 Blaster	90-93	DAT08077*	6,93	DAT08073	10,23
YFS 200 Blaster	94-02	DAT08070		DAT08073	10,23
YFS 200 Blaster	03-07	DAT08068SL	6,44	DAT08179	6,77
YFM 250 Beartracker	99-00	DAT08069SL	6,11	DAT08076	6,11
YFM 250 Big Bear	07-09	DAT08069SL	6,11	DAT08178	6,77
YFM 250 Bruin	05-06	DAT08069SL	6,11	DAT08178	6,77
YFM 350 Big Bear (semiauto.)	87-99	DAT08069SL	6,11	DAT08072	6,11
YFM 350 Bruin	04-06	DAT08069SL	6,11	DAT08178	6,77
YFM 350 Grizzly	07-14	DAT08069SL	6,11	DAT08178	6,77
YFM 350 Raptor	04-09	DAT08069SL	6,11	DAT08179	6,77
YFM 350 Wolverine	95-01	DAT08068BK	6,44	DAT08071	6,93
YFM 350 Warrior	87-01	DAT08068BK	6,44	DAT08071	6,93
YFM 350 Warrior	02-04	DAT08068SL	6,44	DAT08179	6,77
YFZ 350 Banshee	87-01	DAT08068SL	6,44	DAT08071	6,93
YFZ 350 Banshee	02-06			DAT08179	6,77
YFM 400 Kodiak	93-99	DAT08069SL	6,11	DAT08072	6,11
YFM 400 Big Bear	02-04	DAT08069SL	6,11	DAT08178	6,77
YFM 400 Big Bear	02-12	DAT08069SL	6,11	DAT08178	6,77
YFM 400 Kodiak	00-01	DAT08067	6,93		
YFM 400 Grizzly	07-08	DAT08069SL	6,11	DAT08178	6,77
YFZ 450	04-05	DMX08404	5,57	DAT08162	10,82
YFZ 450	07-13	DMX08404	5,57	DAT08160*	
YFZ 450 R	09-16	DMX08404	5,57	DAT08180	15,18
YFM 450 Grizzly	07-14	DAT08069SL	6,11	DAT08178	6,77
YFM 450 Wolverine	06-09	DAT08069SL	6,11	DAT08178	6,77
YFM 600 Grizzly	98-01	DAT08069SL	6,11	DAT08072	6,11
YFM 660 Raptor	01-05	DAT08068SL	6,44	DAT08179	6,77
YFM 660 Grizzly	02-08	DAT08070	4,50	DAT08178	6,77
YFM 700 Raptor	2006	DAT08069SL	6,11	DAT08179	6,77
YFM 700 Raptor	07-13	DAT08069SL	6,11	DAT08180	15,18
YFM 700 Raptor	14-16	DAT08069SL	6,11	DAT08182	8,42

CHASIS



BRONCO Fundas asiento

Diseñado para encajar perfectamente en el asiento original de tu ATV

Color NEGRO, resistente a los rayos ultravioleta, resistente al agua, proporciona tracción adicional bajo cualquier condición de conducción.

Incluye instrucciones para rápida y fácil instalación.

€

40,15

€

33,20

ARCTIC CAT	Año	Referencia
400 todos	06-13	DAT04601
450 todos	11-13	DAT04601
500 todos	05-13	DAT04601
550 todos	10-13	DAT04601
650 todos	05-11	DAT04601
700 todos	06-13	DAT04601
1000 todos	10-13	DAT04601

CAN AM	Año	Referencia
Outlander 500 (Excep.MAX)	07-13	DAT04602
Renegade 500	08-15	DAT04603
Outlander 650 (Excep.MAX)	07-13	DAT04602
Outlander 800 (Excep.MAX)	06-13	DAT04602
Renegade 800	07-15	DAT04603
Outlander 1000	2013	DAT04602
Renegade 1000	12-15	DAT04603

HONDA	Año	Referencia
TRX 90	93-06	DAT04604
TRX 200	90-98	DAT04605
TRX 250 Recon	97-05	DAT04606
TRX 250 Fourtrax Recon	05-14	DAT04607
TRX 250 EX Sportrax	01-05	DAT04608
TRX 250 EX Sportrax	06-14	DAT04612
TRX 250 X	87-92	DAT04609
TRX 300 Fourtrax	88-04	DAT04610
TRX 300 EX	93-06	DAT04609
TRX 350 / 400 Fourtrax Rancher	00-03	DAT04620
TRX 350 / 400 Fourtrax Rancher	04-07	DAT04611
TRX 400 FW Foreman	95-01	DAT04624
TRX 400 Foreman / Fourtrax	95-03	DAT04613
TRX 400 EX Sportrax	99-07	DAT04614
TRX 420 Fourtrax Rancher	07-10	DAT04615
TRX 420 Fourtrax Rancher	11-13	DAT04616
TRX 450 S / ES Foreman	98-05	DAT04617
TRX 450 R	04-09	DAT04625
TRX 500 FW Rubicon	01-04	DAT04618
TRX 500 Foreman / Rubicon	05-14	DAT04619
TRX 500 Foreman	05-11	DAT04619
TRX 650 Rincon	03-05	DAT04621
TRX 680 Rincon	06-15	DAT04621

KAWASAKI	Año	Referencia
KFX 80	03-06	DAT04622
KLF 220 A Bayou	88-02	DAT04623
KLF 250 Bayou	02-10	DAT04623
KLF 300 B Bayou	89-04	DAT04629
KLF 300 C 4x4 Bayou	89-05	DAT04626
KVF 300 / 400 Prairie	97-02	DAT04627
KVF 360 Prairie	02-13	DAT04628
KLF 400 4x4 Bayou	93-99	DAT04629
KXF 400	03-06	DAT04630
KFX 450 R	08-14	DAT04631
KVF 650 Brute Force (carbu)	05-14	DAT04632
KVF 650I Brute Force	05-14	DAT04633
KVF 650 Prairie	03-07	DAT04632
KVF 700 Prairie	03-07	DAT04632
KFX 700	03-09	DAT04634
KVF 750I Brute Force	05-14	DAT04633

POLARIS	Año	Referencia
250 todos	90-95	DAT04635
300 Xplorer	96-99	DAT04636
300 Xpress	96-99	DAT04636
325 Magnum	00-02	DAT04636
325 Xpedition	00-02	DAT04636
330 Trail Boss	02-09	DAT04637
335 Sportsman	99-00	DAT04636
400 todos	90-95	DAT04635
400 Sportsman	96-02	DAT04636
400 Sportsman	01-04	DAT04637
400 Sportsman	2005	DAT04638
400 Xplorer	96-02	DAT04636
400 Hawkeye HO	11-14	DAT04638
400 Sportsman HO	2013	DAT04638
425 Xpedition	00-02	DAT04636
450 Sportsman	06-07	DAT04638
500 Diesel	99-00	DAT04636
500 Sportsman	03-04	DAT04637
500 Sportsman	05-13	DAT04638
550 Sportsman	09-14	DAT04639
600 Sportsman	03-04	DAT04637
700 Sportsman	02-03	DAT04636
700 Sportsman	03-04	DAT04637
700 Sportsman	05-07	DAT04638
800 Sportsman	05-13	DAT04638
850 Sportsman XP	09-10	DAT04638
850 Sportsman XP	11-14	DAT04639
1000 Sportsman	2015	DAT04639

SUZUKI	Año	Referencia
LT 160 Quad Runner	03-04	DAT04640
LT-F 160 Quad Runner	89-01	DAT04640
LT 250	91-95	DAT04641
LT 250 R	87-93	DAT04642
LT-F 250 F	99-02	DAT04643
LT-F 250 Ozark	02-09	DAT04644
LT-F 250 Quad Runner	87-98	DAT04645
LT-Z 250 Quadsport	03-09	DAT04646
LT-F 300 F	99-02	DAT04643
LT-A 400 Eiger	02-07	DAT04647
LT-F 400 Eiger	02-07	DAT04647
LT-A 400 King Quad	08-11	DAT04648
LT-F 400 King Quad	08-11	DAT04648
LT-Z 400 Quadsport	03-13	DAT04630
LT-A 450 King Quad	06-09	DAT04649
LT-A 500 King Quad	09-15	DAT04649
LT-A 500 Vinson	02-07	DAT04651
LT-F 500 F	98-02	DAT04652
LT 500 R	87-90	DAT04653
LT-A 550 King Quad	2012	DAT04649
LT-A 700 King Quad	05-11	DAT04649
LT-A 750 King Quad	08-15	DAT04649

YAMAHA	Año	Referencia
YFM 125 Grizzly	04-13	DAT04654
YFS 200 Blaster	88-06	DAT04655
YFB 250 Timberwolf	92-01	DAT04656
YFM 250 Beartracker	99-04	DAT04657
YFM 250 Big Bear	07-09	DAT04658
YFM 250 Bruin	05-06	DAT04658
YFM 250 Raptor	08-13	DAT04659
YFM 350 Wolverine	95-05	DAT04661
YFM 350 Big Bear	87-01	DAT04662
YZF 350 Banshee	87-06	DAT04663
YFM 350 Bruin	04-06	DAT04658
YFM 350 Grizzly	05-15	DAT04658
YFM 350 Raptor	04-13	DAT04665
YFM 400 Big Bear	00-06	DAT04666
YFM 400 Big Bear	07-12	DAT04667
YFM 400 Kodiak	93-95	DAT04676
YFM 450 Grizzly	05-16	DAT04658
YFM 450 Kodiak	00-06	DAT04658
YFM 550 Grizzly	09-11	DAT04668
YFM 550 Grizzly	12-14	DAT04669
YFM 600 Grizzly	97-01	DAT04670
YFM 660 Grizzly	02-08	DAT04671
YFM 660 R Raptor	01-05	DAT04672
YFM 700 Grizzly	07-11	DAT04668
YFM 700 Grizzly	12-14	DAT04669
YFM 700 R Raptor	06-12	DAT04673





X-21



X-25



X-99

XPEED Protectores aluminio para Quad deportivo

Los precios son para protectores en color de aluminio.
Bajo pedido de 3 semanas se puede entregar pintado o cincado, en color negro u otro, pero con un incremento de un 10% y previo pago.



X-61



X-00

€
84,62

€
91,07

€
38,49

€
48,27

€
88,80

		X-21 DEFENSA DELANTERA	X-25 DEFENSA DELANTERA	X-99 ANTI-VUELCO	X-69 PROTECTOR LATERAL	X-00 PROTECTOR DISCO CADENA
CAN AM						
	Año	Referencia	Referencia	Referencia	Referencia	Referencia
DS 250	06-12	P1658	P1758			
DS 650	00-07	P1627	P1727			
DS 450 EFI	08-14	P1622	P1722	P4822	P4322	P4122
HONDA						
	Año	Referencia	Referencia	Referencia	Referencia	Referencia
TRX 400 Sportrax	99-07	P167A	P177A			P4107
TRX 400 Sportrax	08-13	P167A	P177A			P4107
TRX 450 R	00-06	P1606	P1706	P4806		P4106
TRX 450 R	07-15	P1615	P1715	P4815	P4315	P4115
TRX 700	08-09	P1651	P1751	P4851		
KAWASAKI						
	Año	Referencia	Referencia	Referencia	Referencia	Referencia
KFX 400	03-06	P1613	P1713	P4813	P4313	P4113
KFX 450 R	08-13	P1605	P1705	P4805	P4305	P4105
KFX 700 V-Force	04-09	P1624	P1724	P4824		P4124
KTM						
	Año	Referencia	Referencia	Referencia	Referencia	Referencia
SX 450	09-10	P1617	P1717	P4817	P4317	P4117
XC 450	08-10	P1617	P1717	P4817	P4317	P4117
SX 525	09-10	P1617	P1717	P4817	P4317	P4117
XC 525	08-10	P1617	P1717	P4817	P4317	P4117
KYMCO						
	Año	Referencia	Referencia	Referencia	Referencia	Referencia
KXR 250		P1610	P1710	P4810		P4110
KXR 300		P1611	P1711	P4811		P4111
POLARIS						
	Año	Referencia	Referencia	Referencia	Referencia	Referencia
Outlaw 500	06-07	P1616	P1716	P4816		P4116
Predator 500	03-07	P1614	P1714	P4814		P4114
Scrambler 500	97-12	P1628	P1728			
Outlaw 525	07-11	P1616	P1716	P4816		P4144
SUZUKI						
	Año	Referencia	Referencia	Referencia	Referencia	Referencia
LT-Z 250	04-09	P1630	P1730	P4830		
LT-Z 400	03-08	P1602	P1702	P4802	P4302	P4148
LT-Z 400	09-12	P1602	P1702	P4848	P4348	P4148
LT-R 450	06-09	P1601	P1701	P4801	P4301	P4101
YAMAHA						
	Año	Referencia	Referencia	Referencia	Referencia	Referencia
YFS 200 Blaster	88-06	P1626	P1726	P4826		P4126
YFM 250 R	08-13	P1618	P1718	P4818		P4118
YFM 350 R	04-13	P1608	P1708	P4808	P4308	P4108
YFM 350 Warrior	87-04	P1631	P1731			P4131
YFZ 350 Banshee	87-06	P1623	P1723	P4823		P4123
YFZ 450	04-05	P1604	P1704	P4804	P4304	P414A
YFZ 450	2006	P1604	P1704	P4804	P4304	P414B
YFZ 450	07-13	P1604	P1704	P4804	P4304	P414C
YFZ 450 R	09-16	P1655	P1755	P4855	P4355	P4155
YFM 660 Raptor	01-05	P1609	P1709	P4809	P4309	P4109
YFM 700 Raptor	06-16	P1603	P1703	P4803	P4303	P4103



X-11
X-12



X-15



X-40

Las protecciones de plástico PEHD están fabricadas con material de 6 o 8 mm de alta densidad, confiriendo una dureza similar al aluminio pero indeformable

XPEED Protectores aluminio y PEHD para Quad deportivo

Los precios son para protectores en color de aluminio.

Bajo pedido de 3 semanas se puede entregar pintado o cincado, en color negro u otro, pero con un incremento de un 10% y previo pago.

€
81,92

€
81,92

€
71,63

€
105,12

€
17,50

X-11 PROTECTOR CHASIS PLÁSTICO PEHD	X-12 PROTECTOR CHASIS ALUMINIO	X-15 PROTECTOR TRAPECIOS PLÁSTICO PEHD	X-40 PROTECTOR PIES ALUMINIO	TIRAS RECAMBIO PROTECTOR PIES
---	--------------------------------------	--	------------------------------------	-------------------------------------

ARCTIC CAT	Año	Referencia	Referencia	Referencia	Referencia	Referencia
DVX 400			P4012		P0112	P14112
CAN AM	Año	Referencia	Referencia	Referencia	Referencia	Referencia
DS 250	06-12				P0158	P14113
DS 650	00-07		P4022		P0122	P14110
DS 450 EFI	08-12				P0127	P14121
HONDA	Año	Referencia	Referencia	Referencia	Referencia	Referencia
TRX 400 Sportrax	99-07	P5807	P4007	P4507	P0107	P14127
TRX 400 Sportrax	08-13	P5807	P4007	P4507	P017A	P14127
TRX 450 R	00-06	P5806	P4006		P0106	P14110
TRX 450 R	07-13	P5815	P4015	P4515	P0115	P14113
TRX 700	08-09				P0151	P14106
KAWASAKI	Año	Referencia	Referencia	Referencia	Referencia	Referencia
KFX 400	03-06		P4013		P0113	P14112
KFX 450 R	08-13	P5805	P4005	P4505	P0105	P14106
KFX 700 V-Force	04-09		P4024		P0124	P14113
KTM	Año	Referencia	Referencia	Referencia	Referencia	Referencia
SX 450	09-10	P5817	P4017	P4517	P0117	P14119
XC 450	08-10	P5817	P4017	P4517	P0117	P14119
SX 525	09-10	P5817	P4017	P4517	P0117	P14119
XC 525	08-10	P5817	P4017	P4517	P0117	P14119
KYMCO	Año	Referencia	Referencia	Referencia	Referencia	Referencia
KXR 250			P4010		P0110	P14105
KXR 300			P4011		P0111	P14105
POLARIS	Año	Referencia	Referencia	Referencia	Referencia	Referencia
Outlaw 500	06-07		P4016		P0116	P14106
Predator 500	03-07		P4014		P0114	P14107
Outlaw 525	07-11		P4044		P0144	P14107
SUZUKI	Año	Referencia	Referencia	Referencia	Referencia	Referencia
LT-Z 250	04-09				P0130	P14105
LT-Z 400	03-08		P4002	P4502	P0102	P14101
LT-Z 400	09-12		P4048	P4548	P0148	P14112
LT-R 450	06-09		P4001	P4501	P0101	P14112
YAMAHA	Año	Referencia	Referencia	Referencia	Referencia	Referencia
YFS 200 Blaster	88-06				P0126	P14116
YFM 250 R	08-12	P5818	P4018	P4518	P0118	P14116
YFM 350 R	04-13	P5808	P4008		P0108	P14113
YFM 350 Warrior	87-04		P4031		P0131	P14113
YFZ 350 Banshee	87-06		P4023		P0123	P14116
YFZ 450	03-13	P5804	P4004	P4504	P0104	P14106
YFZ 450 R	09-16	P5855	P4055	P4555	P0155	P14106
YFM 660 Raptor	01-05	P5809	P4009	P4509	P0109	P14111
YFM 700 Raptor	06-14	P5803	P4003	P4503	P0103	P14106
YFM 700 Raptor	15-16	P5803	P4003	P453A	P0103	P14106

XPEED Tiras de recambio para protector pies

€ 17,50



P14101

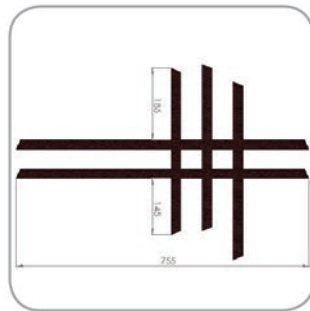

P14105



P14106

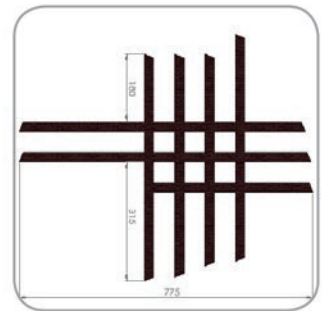

P14107



P14110



P14111

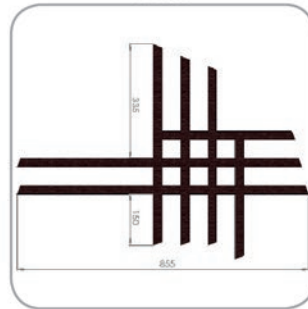

P14112

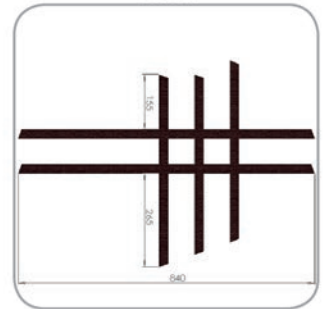

P14113

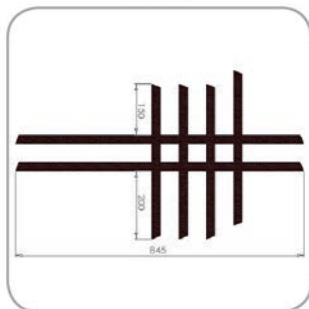

P14116

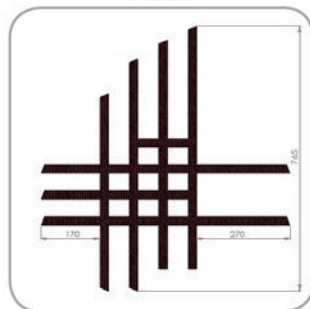

P14119

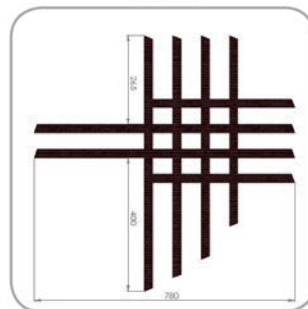

P14121

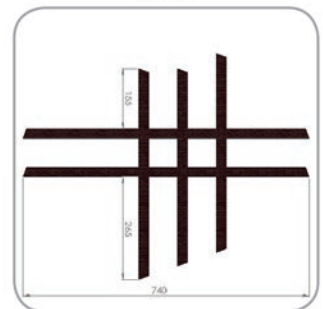

P14127



RUEDAS Y NEUMÁTICOS

MOTOR

ADMISIÓN / ESCAPE
REFRIGERACIÓN

ELECTRICO

SUSPENSIÓN / DIRECCIÓN

FRENOS

TRANSMISIÓN

CONTROLES Y MANDOS

CHASIS

ACCESORIOS

BRONCO 10 Remaches plástico

Remache para los plásticos de los ATV-UTV.
Se sirve en bolsas de 10 unidades. Precio por bolsa.

Referencia	A	B	C	
DAT04025	8,0	15	22	Can Am
DAT04290	7,8	20	22	Honda / Kawasaki / Suzuki / Yamaha
DAT04291	7,7	19,5	20,6	Honda / Kawasaki / Suzuki / Yamaha
DAT04292	6,8	19,8	11	
DAT04293	6,0	14	12,2	
DUP12040	5,9	12	15,5	
DUP12440	3,85	17,17	24,7	Articat / Polaris
DUP12443	6	17,8	22,7	Polaris
DUP12444	2,8	12,05	25,83	Polaris
DUP12445	4,7	12,25	25,7	Polaris
DUP12446	8,5	18,75	15	Can Am

Referencia	A	B	C
DUP12447WI	9,3	13	8
DUP12447BK	9,3	13	8
DUP12449	7,4	13	8,4
DUP12451WI	11,4	15	8,45
DUP12451BK	11,4	15	8,45

€
6,60

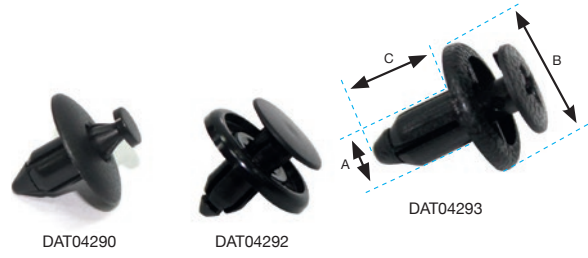

2 Gomas sujeción capó

Referencia	€
D1213501	5,30
D1213401	5,30
DSM12323	
DSM12327	5,92



XPEED Protectores aluminio para ATV

Los precios son para protectores en color de aluminio.
Bajo pedido de 3 semanas se puede entregar pintado o cincado, en color negro u otro, pero con un incremento de un 10% y previo pago.

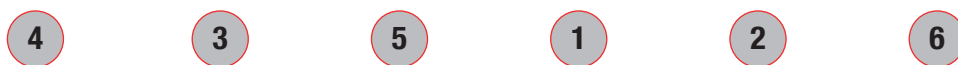
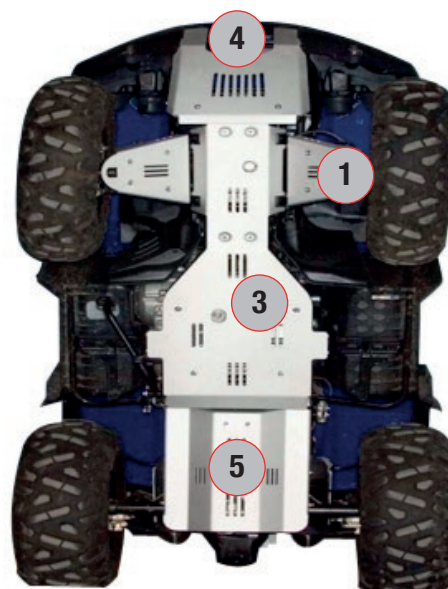

		4		3		5		1		2		6	
		X-71 PROTECTOR CÁRTER FRONTAL		X-72 PROTECTOR CÁRTER CENTRAL		X-73 PROTECTOR CÁRTER TRASERO		X-74 PROTECTORES TRAPECIOS DELANTEROS		X-75 PROTECTORES TRAPECIOS TRASEROS		X-76 PROTECTOR CARDAN	
CAN AM	Año	Referencia	€	Referencia	€	Referencia	€	Referencia	€	Referencia	€	Referencia	€
Outlander 500	06-12	P6435	119,35	P6635	197,43	P6535	46,30	P3835	66,13	P3935	86,55	P10535	67,58
Outlander Max 500	06-12	P644	93,73	P6643	130,28	P6543	55,05	P3843	74,85	P3943	95,28	P10543	76,30
Renegade 500	08-12	P6442	109,45	P6642	146,00	P6542	70,78	P3842	90,58	P3942	111,00	P10542	67,58
Outlander 650	06-12	P6435	119,35	P6635	197,43	P6535	46,30	P3835	66,13	P3935	86,55	P10535	67,58
Outlander Max 650	06-12	P644	93,73	P6643	130,28	P6543	55,05	P3843	74,85	P3943	95,28	P10543	76,30
Outlander 800	06-12	P6435	119,35	P6635	197,43	P6535	46,30	P3835	66,13	P3935	86,55	P10535	67,58
Outlander Max 800	06-12	P644	93,73	P6643	130,28	P6543	55,05	P3843	74,85	P3943	95,28	P10543	76,30
Renegade 800	08-12	P6442	109,45	P6642	146,00	P6542	70,78	P3842	90,58	P3943	111,00	P10543	67,58
Outlander 1000 XMR	13-15	P6485	65,58	P6685	197,13	P6585	90,50	P3885	132,88	P3985	113,70		
Outlander Max 1000	13-15	P6442	109,45	P6686	200,28	P6542	70,78	P3886	136,05	P3986	116,85		
Renegade 1000	12-15	P6479	65,70	P6679	211,08	P6579	98,58	P3879	115,13	P3979	117,55	P10579	203,38
GOES	Año	Referencia	€	Referencia	€	Referencia	€	Referencia	€	Referencia	€	Referencia	€
520 Max	todos	P6450	88,93	P6650	116,73	P6550	97,28	P3850	110,55	P3950	96,78		
HONDA	Año	Referencia	€	Referencia	€	Referencia	€	Referencia	€	Referencia	€	Referencia	€
Rincon 680	06-14	P6450	90,70	P6650	154,50	P6550	75,35	P3850	66,13	P3950	140,08		
KAWASAKI	Año	Referencia	€	Referencia	€	Referencia	€	Referencia	€	Referencia	€	Referencia	€
KVF 650 Brute Force	05-13	P6440	112,95	P6640	121,55	P6540	46,30	P3840	71,73	P3940			
KVF 750 Brute Force	05-08	P6437	74,70	P6637	140,78	P6537	65,55	P3837	85,35	P3937	134,08		
KVF 750 Brute Force	08-11	P6452	158,08	P6652	148,45	P6552	84,78	P3852	104,58	P3952	120,45		
POLARIS	Año	Referencia	€	Referencia	€	Referencia	€	Referencia	€	Referencia	€	Referencia	€
Scrambler 500	05-07	P6441	85,00	P6641	141,55	P6541	110,00	P3841	66,13	P3941			
Sportsman 500 EFI	08-09	P6446	94,05	P6646	168,20	P6546	116,95	P3846	73,80	P3946	75,00		
Sportsman 700	03-07	P6438	51,55	P6638	316,55	P6538	118,88	P3838	119,15	P3938	86,15		
Sportsman 800 EFI X2	08-09	P6446	94,05	P6646	168,20	P6546	116,95	P3846	73,80	P3946	75,00		
Sportsman 800 Twin	05-13	P6438	51,55	P6638	316,55	P6538	118,88	P3838	119,15	P3938	86,15		
Sportsman 850 XP	09-13	P6460	91,05	P6660	263,30	P6560	123,23	P3860	93,05	P3960	113,08		
SUZUKI	Año	Referencia	€	Referencia	€	Referencia	€	Referencia	€	Referencia	€	Referencia	€
LT-A 450 King Quad	07-10	P6449	96,55	P6649	122,38	P6549	57,85	P3849	77,65	P3949	146,13		
LT-A 700 King Quad	05-07	P6449	96,55	P6649	122,38	P6549	57,85	P3849	77,65	P3949	146,13		
LT-A 750 King Quad	08-13	P6449	96,55	P6649	122,38	P6549	57,85	P3849	77,65	P3949	146,13		
LT-A 750 King Quad	08-12	P6462	85,65	P6662	121,55	P6562	55,28	P3862	122,58	P3962	134,58		
YAMAHA	Año	Referencia	€	Referencia	€	Referencia	€	Referencia	€	Referencia	€	Referencia	€
YFM 450 Grizzly	07-13	P6472	82,28	P6672	146,93	P6572	82,28	P3872	77,65	P3972	96,15		
YFM 450 Kodiak	04-06	P6472	82,28	P6672	146,93	P6572	82,28	P3872	77,65	P3972	96,15		
YFM 660 Grizzly	02-08	P6436	88,85	P6636	125,38	P6536	87,70	P3836	69,95	P3936	93,85		
YFM 700 Grizzly	07-13	P6447	115,78	P6647	152,30	P6547	77,08	P3847	96,88	P3947	151,43		

RUEDAS Y NEUMÁTICOS

MOTOR

ADMISIÓN / ESCAPE
REFRIGERACIÓN

ELECTRICO

SUSPENSIÓN / DIRECCIÓN

FRENOS

TRANSMISIÓN

CONTROLES Y MANDOS

CHASIS

ACCESORIOS

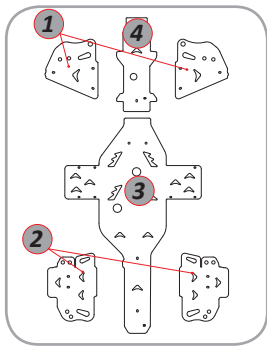

POLARIS
Sportsman 700 / 800 Twin

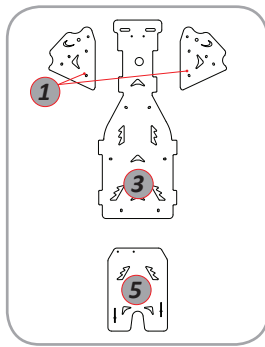

KYMCO
MXU 500

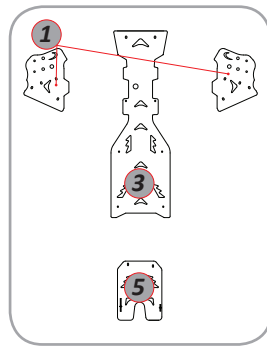

KAWASAKI
Brute Force 650

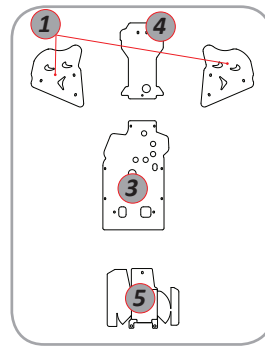

POLARIS
Scrambler 500 HO

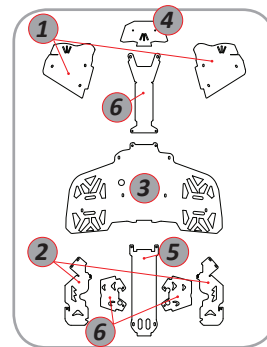

CAN AM
Renegade 500 / 800

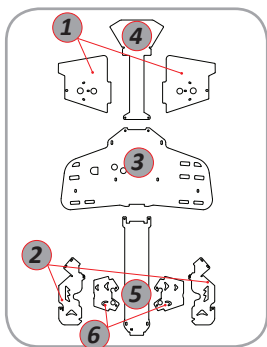

CAN AM
Outlander 500 / 650 / 800 MAX

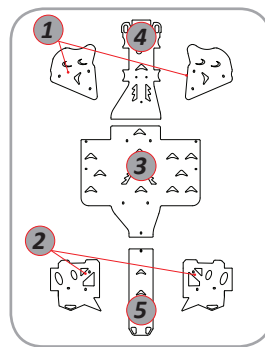

POLARIS
Sportsman 500 / 800 EFI X2

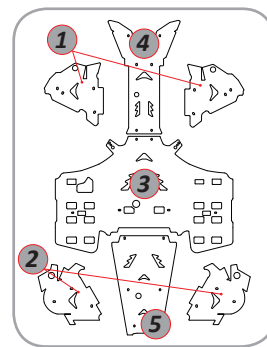

YAMAHA
Grizzly 700

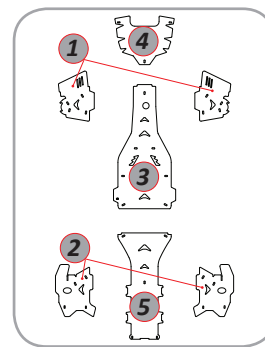

SUZUKI
King Quad 400 / 700 / 750

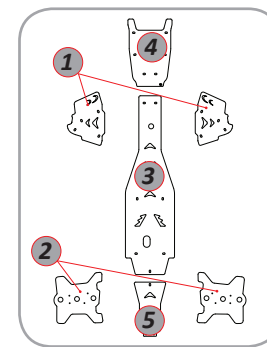

HONDA
Rincon 680

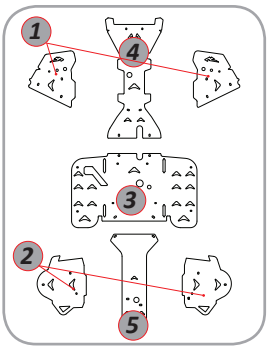

KAWASAKI
Brute Force 750 (09-12)

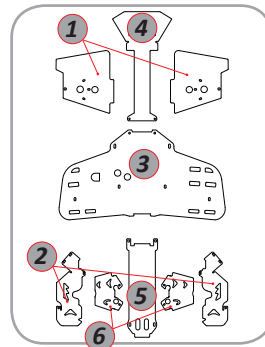

CAN AM
Outlander 500 / 650 / 800

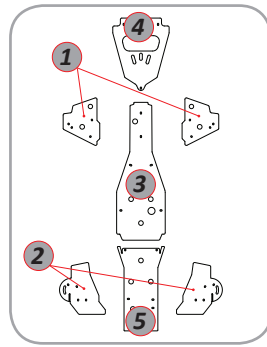

YAMAHA
Grizzly 660

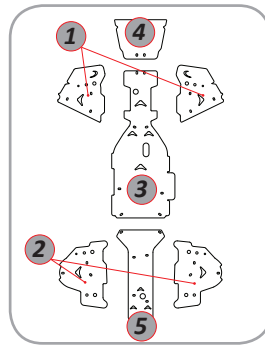

KAWASAKI
Brute Force 750 (05-08)

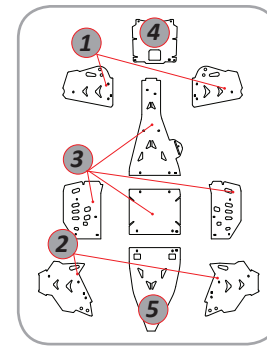

POLARIS
Sportsman 850 XP

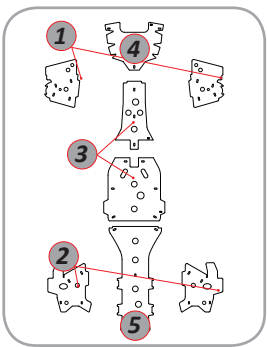

SUZUKI
King Quad 750 AXI

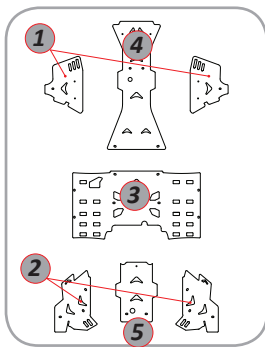

YAMAHA
Grizzly / Kodiak 450

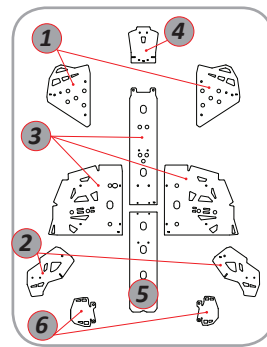

CAN AM
Renegade 1000

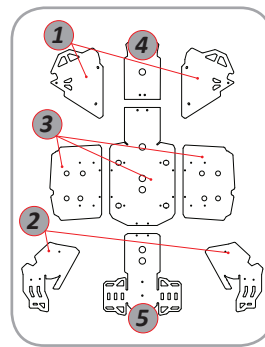

CAN AM
Outlander 1000 XMR

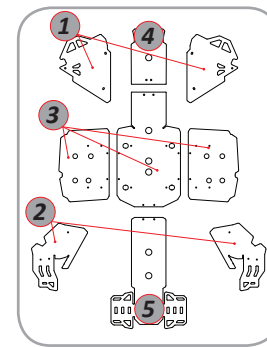

CAN AM
Outlander 1000 MAX

Maverick 1000

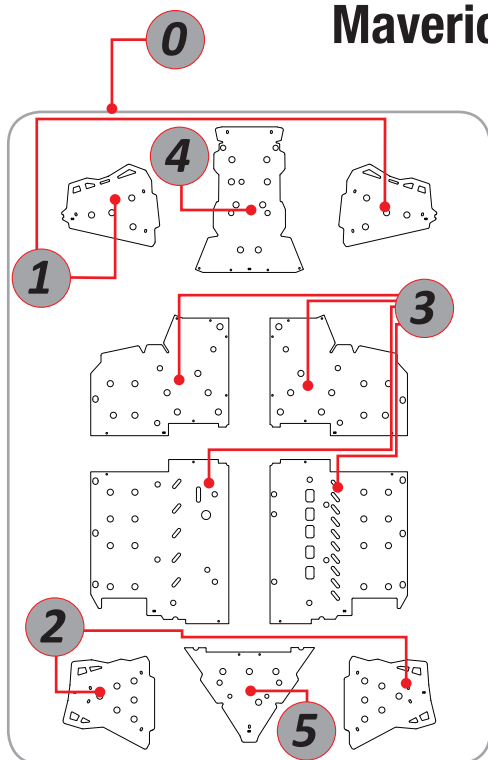

Descripción	ALUMINIO		NEGRO	
	Referencia	€	Referencia	€
0 X-80 Protecciones chasis y trapecios	P5688	1026,92		
1 X-81 Protectores trapecios delanteros	P3888	139,80		
2 X-82 Protectores trapecios traseros	P3988	144,22		
3 X-91 Protector chasis central	P6688	542,05		
4 X-90 Protector chasis delantero	P6488	188,20		
5 X-92 Protector chasis trasero	P6588	102,57		
6 X-88 Puertas	P5088	733,65	P5088N	807,02
7 X-85 Defensa delantera	P6288	173,07	P6288N	190,38
8 X-86 Defensa trasera	P6388	130,77	P6388N	143,85
9 X-89 Barra protección bajos laterales	P5788	176,92		
T X-93 Techo	P17588	247,50	P17588N	272,25
E Separadores delanteros	P5242	56,86		
E Separadores traseros	P5242	56,86		

Artículo bajo pedido, con plazo de entrega de 3 semanas.

Commander 800 / 1000 12-15



Descripción	ALUMINIO		NEGRO	
	Referencia	€	Referencia	€
0 X-80 Protecciones chasis y trapecios	P5663	664,62		
1 X-81 Protectores trapecios delanteros	P3863	127,92		
2 X-91 Protector chasis central	P6663	387,45		
3 X-90 Protector chasis delantero	P6463	109,22		
4 X-92 Protector chasis trasero	P6563	134,05		
5 X-88 Puertas	P5063	617,35	P5063N	679,08
6 X-85 Defensa delantera	P6263	201,15	P6263N	221,26
7 X-89 Barra protección bajos laterales	P5763	86,92	P5763N	95,61
8 Separadores delanteros	P5242	56,86		
9 Separadores traseros	P5242	56,86		

Artículo bajo pedido, con plazo de entrega de 3 semanas.

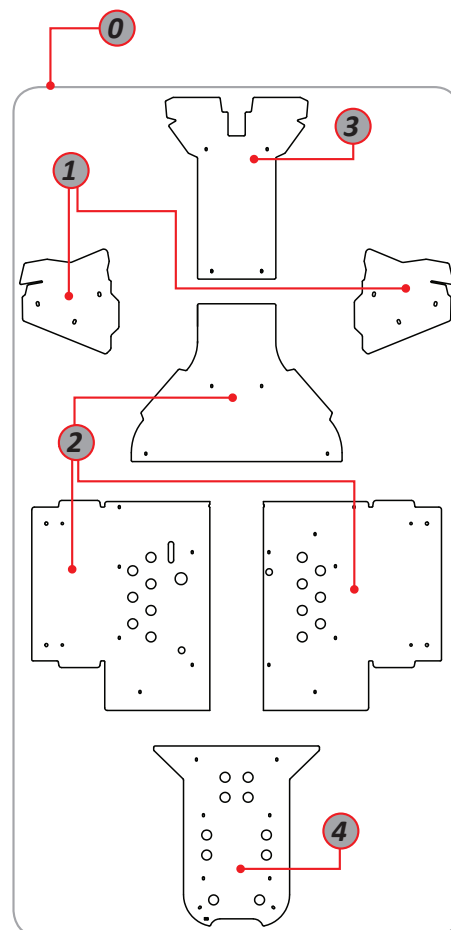

RUEDAS Y NEUMÁTICOS

MOTOR

ADMISIÓN / ESCAPE
REFRIGERACIÓN

ELECTRICO

SUSPENSIÓN / DIRECCIÓN

FRENOS

TRANSMISIÓN

CONTROLES Y MANDOS

CHASIS

ACCESORIOS

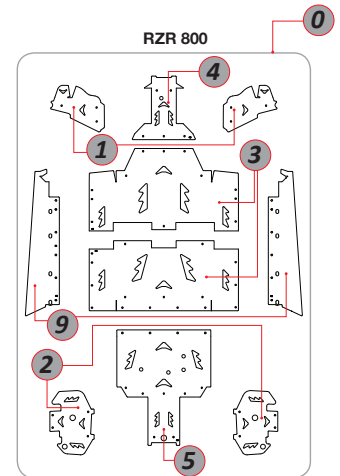

RZR 800 08-14

		ALUMINIO		NEGRO	
	Descripción	Referencia	€	Referencia	€
0	X-80	P5645	1008,15		
1	X-81	P3845	103,85		
2	X-82	P3945	113,00		
3	X-91	P6645	350,00		
4	X-90	P6445	86,92		
5	X-92	P6545	182,07		
6	X-88	P5045	583,40	P5045N	641,74
7	X-85	P6245	173,07	P6245N	190,38
8	X-86	P6345	115,37	P6345N	126,91
9	X-89	P5745	211,15		

Artículo bajo pedido, con plazo de entrega de 3 semanas.

RZR 800 S 09-14

		ALUMINIO		NEGRO	
	Descripción	Referencia	€	Referencia	€
0	X-80	P5666	1008,15		
1	X-81	P3866	103,85		
2	X-82	P3966	113,00		
3	X-91	P6645	350,00		
4	X-90	P6445	86,92		
5	X-92	P6566	182,07		
6	X-88	P5045	583,40	P5045N	641,74
7	X-85	P6245	173,07	P6245N	190,38
8	X-86	P6345	115,37	P6345N	126,91
9	X-89	P5766	211,15		

Artículo bajo pedido, con plazo de entrega de 3 semanas.

RZR 900 11-14

		ALUMINIO		NEGRO	
	Descripción	Referencia	€	Referencia	€
0	X-80	P5678	1115,37		
1	X-81	P3878	128,92		
2	X-82	P3978	131,80		
3	X-91	P6678	444,70		
4	X-90	P6478	105,00		
5	X-92	P6578	138,07		
6	X-88	P5078	583,39	P5078N	641,74
7	X-85	P6278	201,15	P6278N	221,26
8	X-86	P6378	161,22	P6378N	177,34
9	X-89	P5778	192,30		

Artículo bajo pedido, con plazo de entrega de 3 semanas.

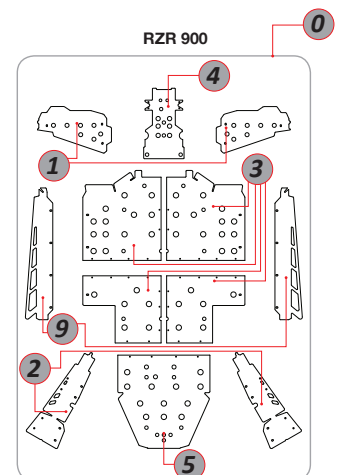
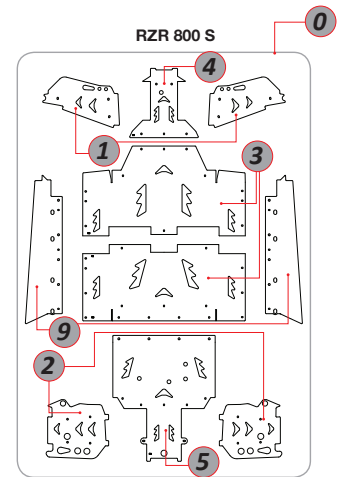

RZR 900 S 2015

	Descripción	ALUMINIO		NEGRO	
		Referencia	€	Referencia	€
0	X-80	P5689	973,55		
1	X-81	P3889	93,07		
2	X-82	P3989	92,80		
3	X-91	P6689	539,15		
4	X-90	P6489	76,92		
5	X-92	P6589	195,07		
7	X-85	P6287	201,15	P6278N	221,26
8	X-86	P6387	177,35	P6378N	195,08
9	X-89	P5787	66,95	P5787N	73,64
T	X-93	P17587	247,50	P17587N	272,25

Artículo bajo pedido, con plazo de entrega de 3 semanas.

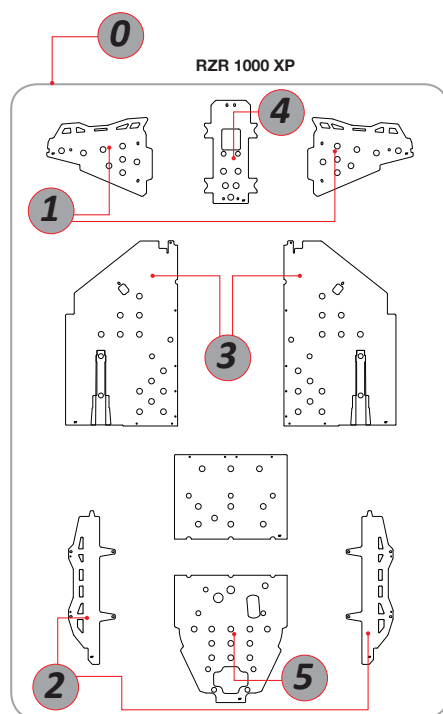
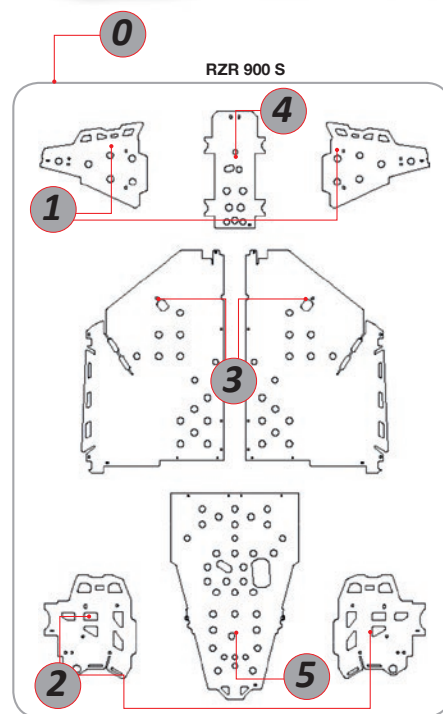

RZR 1000 XP 14-16

	Descripción	ALUMINIO		NEGRO	
		Referencia	€	Referencia	€
0	X-80	P5687	973,55		
1	X-81	P3887	93,07		
2	X-82	P3987	92,80		
3	X-91	P6687	539,15		
4	X-90	P6487	76,92		
5	X-92	P6587	195,07		
6	X-88	P5087	733,66	P5087N	807,03
7	X-85	P6287	201,15	P6287N	221,26
8	X-86	P6387	177,35	P6387N	195,08
9	X-89	P5787	66,95	P5787N	73,64
T	X-93	P17587	247,50	P17587N	272,25

Artículo bajo pedido, con plazo de entrega de 3 semanas.



Separadores para los RZR

	Descripción	Referencia	€
E	Separadores delanteros	P5232	56,86
E	Separadores traseros	P5232	56,86

RUEDAS Y NEUMÁTICOS

MOTOR

ADMISIÓN / ESCAPE
REFRIGERACIÓN

ELÉCTRICO

SUSPENSIÓN / DIRECCIÓN

FRENOS

TRANSMISIÓN

CONTROLES Y MANDOS

CHASIS

ACCESORIOS

YXZ 1000 R 16-17

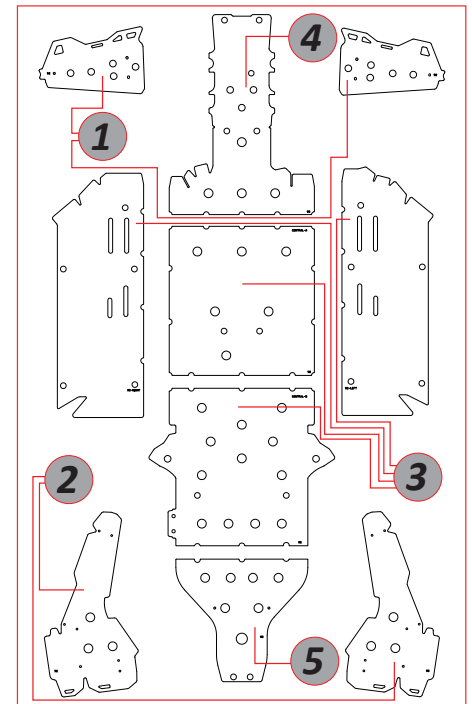

	ALUMINIO		NEGRO			
	Descripción	Referencia	Referencia	€		
1	X-81	Protectores trapecios delanteros	P3892	96,14		
2	X-82	Protectores trapecios traseros	P3992	95,86		
3	X-91	Protector chasis central	P6692	647,01		
4	X-90	Protector chasis delantero	P6492	199,76		
5	X-92	Protector chasis trasero	P6592	153,26		
7	X-85	Defensa delantera	P6292	185,06	P6281N	221,26
8	X-86	Defensa trasera	P6392	152,78	P6381N	177,34
9	X-89	Barra protección bajos laterales	P5792	163,62		
E		Separadores delanteros / traseros	P5255			
P		Deflector	P18592	130,77		

Artículos bajo pedido, con plazo de entrega de 3 semanas.

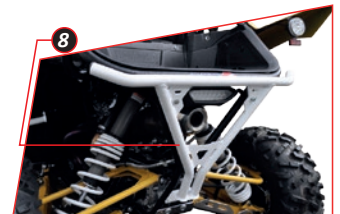

WILD CAT 1000 12-16

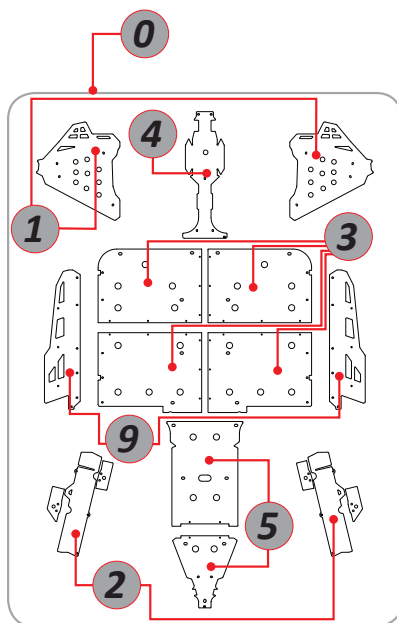

	ALUMINIO		NEGRO			
	Descripción	Referencia	Referencia	€		
0	X-80	Protecciones chasis y trapecios	P5681	1134,62		
1	X-81	Protectores trapecios delanteros	P3881	210,77		
2	X-82	Protectores trapecios traseros	P3981	170,77		
3	X-91	Protector chasis central	P6681	391,55		
4	X-90	Protector chasis delantero	P6481	117,95		
5	X-92	Protector chasis trasero	P6581	124,85		
6	X-88	Puertas	P5081	731,09	P5081N	804,20
7	X-85	Defensa delantera	P6281	201,15	P6281N	221,26
8	X-86	Defensa trasera	P6381	161,22	P6381N	177,34
9	X-89	Barra protección bajos laterales	P5781	130,65		
E		Separadores delanteros	P5228	56,86		
E		Separadores traseros	P5228	56,86		

Artículos bajo pedido, con plazo de entrega de 3 semanas.

ACCESORIOS Y EQUIPAMIENTO



ACCESORIOS Y EQUIPAMIENTO

Redes elásticas

Referencia	Ganxo	Dimensiones	€
X12142	Plástico	15x15	4,00
XMC12254	Plástico	18x18	3,30
X78-60500	Hierro	15x15	4,26
X78-60510	Hierro	15x30	6,38

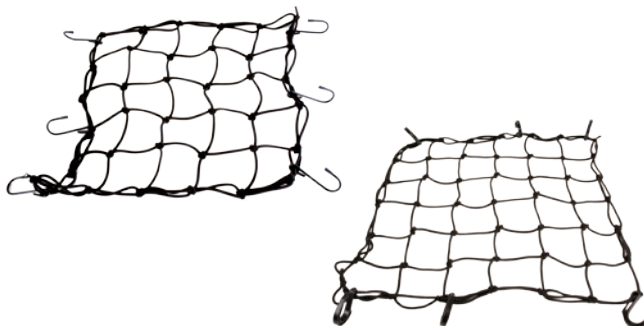

Correas

Referencia	Tipo	Descripción	€
X4507	3	Blister 4 correas 900 kg.	16,66
X12136	3	Correa 450 kg. 1,50 m.	3,80
X12138	1	Correa 450 kg. 2,5 cm x 4,5 m.	4,80
X1213801	1	Correa 450 kg. 2,5 cm x 2,4 m.	3,60
X92716	2	Correa con carraca 450 kg. 2,5 cm x 5 m.	4,10
X78-73359	3	2 Correas 1600 kg. 2,5 cm. x 2,40 m.	8,23

Candados

Referencia	Descripción	€
XMP12420	Candado de disco de freno	11,00
XMP12423	Candado cadena	18,71



Pulpos

Referencia	Descripción	€
X1252504	2 pulpos de Ø 10mm x 60cm	2,60
X1252502	2 pulpos de Ø 10 mm x 90 cm	2,82



Eslinga de arrastre

Referencia	Descripción	€
X15523	2500 kg. y 6 m.	12,80



Petate hermético

Referencia	€
X488311	14,43



2 Luces químicas

Referencia	€
AZUL DSM16412B	4,00
AMARILLA DSM16412Y	4,00

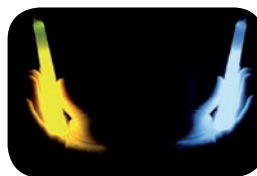

Cuchillo cutter

Referencia	€
DSM12229	8,50



Sierra plegable

Referencia	€
DSM12151	9,20



Minipala multiuso

Referencia	€
DSM12090	13,70





ECO



RACING

Gafas MX / Enduro / ATV

Referencia	Modelo	Descripción	€
DMC169771	Eco	Cross rojas	12,50
DMC169772	Eco	Cross azules	12,50
DMC169773	Eco	Cross negras	12,50
DMC16977A	Eco	Recambio lente	2,95
DMX16076BK	Racing	Cross negras	19,96
DMX16076BU	Racing	Cross azules	19,96
DMX16076RD	Racing	Cross rojas	19,96
DMX16076YL	Racing	Cross amarillas	19,96
DMX16076A	Racing	Recambio lente	6,00
DMX16076B	Racing	Paquete Tear-Off	4,00

RUEDAS Y NEUMÁTICOS

MOTOR

ADMISIÓN / ESCAPE
REFRIGERACIÓN

ELÉCTRICO

SUSPENSIÓN / DIRECCIÓN

FRENOS

TRANSMISIÓN

CONTROLES Y MANDOS

CHASIS

ACCESORIOS

BRONCO Maleta lona para ATV

Referencia	Largo x Ancho x Alto	€
DAT16050	76 x 31 x 21 (30) cm	39,60
DAT16051	90 x 45 x 21 (30) cm	49,24



DAT16050



DAT16051

BRONCO Maleta rígida para ATV

Dispone de 2 cerraduras con candado (no incluidos).

Referencia	Largo x Ancho x Alto	€
DAT12480	95 x 57 x 37 cm	242,73



DAT12480



DAT121651

BRONCO Bandeja de carga pesada ATV

Referencia	Largo x Ancho x Alto	€
DAT121671	91 x 43 x 16 cm	94,08
DAT121661	104 x 43 x 16 cm	120,96
DAT121651	104 x 75 x 16 / 32 cm	162,34



DAT121661



DAT121651

BRONCO Parabrisas estándar para Quad y ATV

Fabricado en material plástico acrílico de 3,5mm de grosor

Referencia	Ancho x Alto	€
DAT06469	85 x 45 cm	76,94
DAT064691	85 x 55 cm	76,23

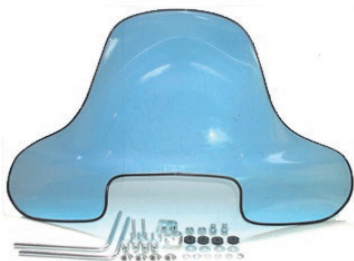

DAT06469



DAT064691

Banderín ATV 1,80m

Referencia	€
DSM12375	14,76



BRONCO Kit de trabajo cabrestante

Referencia	€
DAT120751	49,83



BRONCO Palas de nieve

Se requiere cabrestante para subir y bajar la pala, la inclinación a derechas e izquierdas de la pala se realiza manualmente.



Hoja de 152cm de ancho por 40cm de alto y 3mm de grosor. Con refuerzos. Tenemos cuchillas de recambio.

Referencia	€
DAT124701	218,46



Soporte pala.

Referencia	€
DAT124711	208,68

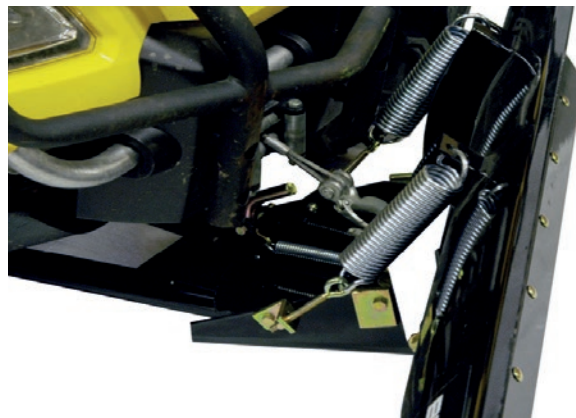



La pala más versátil e innovadora específica para ATV/UTV



Quitar nieve no había sido nunca tan sencillo!!

Su diseño ligero y su manejable hoja especial para no dañar el césped, convertirá tu diversión favorita en la herramienta más valiosa.

La pala Snowsport moverá tanta nieve como tu ATV puede manipular y accederá a esos lugares difíciles de alcanzar, donde las palas tradicionales no pueden llegar.

Escoge el ancho de pala que desees y el anclaje de tu vehículo

Pala de 140 cm

Referencia	Peso (Kg.)	€
S40054	38,50	755,92

Pala de 150 cm

Referencia	Peso (Kg.)	€
S40060	39,50	890,32

Anclaje pala

CAN AM	Año	Referencia	Peso	€
Outlander 500	07-09	S30520	7,85	196,34
Outlander 650	06-09	S30520	7,85	196,34
Outlander 800	05-09	S30520	7,85	196,34
Renegade 850	07-09	S30520	7,85	196,34
HONDA	Año	Referencia	Peso	€
TRX 650 Rincon	03-06	S30560	7,85	196,34
TRX 680 Rincon	03-06	S30560	7,85	196,34
KAWASAKI	Año	Referencia	Peso	€
KVF 650 Brute Force 4x4i	05-08	S50988	7,85	196,34
KVF 750 Brute Force 4x4i	05-08	S50988	7,85	196,34
POLARIS	Año	Referencia	Peso	€
Sportsman 700 Twin 4x4	02-06	S30500	7,85	196,34
Sportsman 800 Twin 4x4	02-06	S30500	7,85	196,34
Ranger	05-06	S40480	7,85	196,34
RZR	08-09	S60044	7,85	196,34
SUZUKI	Año	Referencia	Peso	€
LTA 450 King Quad	07-08	S30530	7,85	196,34
LTA 700 King Quad	05-07	S30530	7,85	196,34
LTA 750 King Quad	08-10	S30530	7,85	196,34
YAMAHA	Año	Referencia	Peso	€
YFM 660 Grizzly	02-06	S30540	7,85	196,34
YFM 700 Grizzly	07-10	S60230	7,85	196,34
YXR 660 Rhino	04-07	S60077	7,85	94,50
YXR 700 Rhino	08-10	S60077	7,85	94,50

Funcionamiento

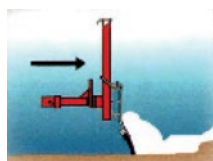

1 Simplemente conduce hacia delante.

Recuerda, con la pala Snowsport no tendrás que utilizar mandos.



2 Deja a la hoja hacer el trabajo.

Seguirá el terreno mientras tú conduces. Esta hoja se ha diseñado especialmente para empujar la nieve amontonándola hacia arriba para maximizar su capacidad.



3 Filo de corte sensible en temperatura.

Se hace más rígido en temporada de frío para cortar a través de la nieve, pero permanece flexible en temporada de calor, por lo que nos proporciona una doble función.

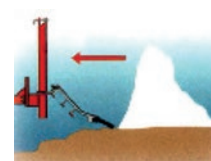

4 Cuando estés preparado para la marcha atrás, simplemente ve hacia atrás.

La hoja sigue activa en movimiento, dejando la nieve en una pila y a ti libre para continuar la conducción.

CONDICIONES DE VENTA

PEDIDOS

Por teléfono: 938.771.550

Horario de atención de lunes a viernes de 9 a 14 horas y de 15 a 19 horas.

Desde nuestra web: www.impnesa.com

Aparte de poder realizar su pedido de forma cómoda y rápida, puede además, consultar stocks, fotos del producto, características, descuentos, etc..

Mail: pedidos@impnesa.com

Indicándonos sus datos de cliente, **referencias** y descripción del producto.

HORARIO RECEPCIÓN Y ENTREGA DE PEDIDOS

El servicio de entrega es de 24h (48h dependiendo de población) durante días laborables.

Los pedidos efectuados de 9:00 a 14:00 se recogen a las 15:00h. Hasta esta hora es posible añadir artículos al pedido. Si se realiza un pedido posteriormente será considerado como nuevo envío.

Los pedidos efectuados de 15:00 a 18:00 se recogen a las 18:00h.

nota: de 17:00h a 18:00h no podemos garantizar su salida

DEVOLUCIONES

Plazo de devolución: 30 días fecha factura y bajo previo aviso. El producto deberá ser devuelto en perfecto estado y en su envoltorio original, asumiendo el cliente los gastos de transporte correspondientes.

En caso de error de IMPNESA, nos ocupamos de realizar el cambio sin coste alguno.

GARANTIAS

Póngase en contacto por e-mail o teléfono.

CONDICIONES COMERCIALES

Los precios del catálogo son de venta a público. No incluyen IVA ni tasas de reciclaje.

Para información sobre descuentos póngase en contacto con su comercial o directamente con la empresa.

FORMAS DE PAGO

*Transferencia nuestra cuenta incluyendo el nº de albarán:

- Para clientes ubicados en España: Banc Sabadell ES65-0081-0049-5400-0122-4125
- Para el resto de países (Andorra, Portugal, ..):

Caixabanc ES90-2100-0295-1402-0025-0497

*Tarjeta de crédito: Únicamente a través de nuestra web www.impnesa.com

■ ■ CONDITIONS DE VENTE

COMMANDES

Par téléphone : avec votre représentant commercial (en français), ou au **00 34 9 38 77 15 50**
(en espagnol ou en anglais)

Horaire d'ouverture aux clients : du lundi au vendredi de 9h à 14h.

Depuis notre site web : www.impnesa.fr

Outre le fait que vous pouvez réaliser votre commande plus confortablement et plus rapidement, vous pouvez consulter les stocks, les photos, les caractéristiques des produits, les remises, etc.

E-mail : commandes@impnesa.fr

Indiquez-nous vos données client, les références et la description du produit.

HORAIRES DE RÉCEPTION ET DE LIVRAISON DE COMMANDES

Le service de livraison s'effectuera au cours des 3-4 jours ouvrables suivant la date de commande (selon la ville).

Les commandes passées entre 9h et 17h sont collectées à 18h. Toute commande sera considérée comme indépendante et sera soumise aux conditions d'envoi. Aucune modification d'envoi ne sera acceptée.

RETOUR

Délais de retour : 30 jours à compter de la date figurant sur le bordereau de livraison et avec notification préalable. Le produit devra être retourné en parfait état ainsi que son emballage d'origine qui sera dûment protégé, le client assumant les frais de port correspondant au retour.

En cas d'erreur de la part d'IMPNESA, nous nous chargeons de réaliser l'échange sans coût additionnel.

GARANTES

Contactez-nous par e-mail à comandes@impnesa.fr ou par téléphone par l'intermédiaire de votre représentant commercial.

CONDITIONS COMMERCIALES

Les prix du catalogue concernent la vente au public. Ils n'incluent pas la TVA ni les taxes de recyclage. Pour plus d'information sur les remises, contactez votre représentant commercial ou l'entreprise directement.

Tous les garages qui disposent de la TVA européenne seront facturés sans inclure la TVA.

Pour ceux qui ne remplissent pas cette condition, l'IVA (la TVA espagnole) de 21 % sera appliquée.

MOYENS DE PAIEMENT:

*Virement bancaire sur notre compte, en indiquant le numéro du bon de commande :

• Banc Sabadell ES65-0081-0049-5400-0122-4125

*Carte bancaire : Uniquement via notre site web : www.impnesa.fr

Hoja de pedido / Bordereau de commande / Order form.

Pedido / Commande / Customer order:

Fecha / Date:

Empresa / Enterprise / Company:

Nº Cliente / Customer Nº:

Dirección / Adresse / Address:

Ciudad / Localité / City:

C.P. / Post code:

Teléfono / Téléphone / Phone Nº:

Fax:

Dirección de entrega / Adresse de livraison / Delivery adress:

Persona de contacto / Personne de contact / Contact person:

Artículos / Articles / Items

* Referencia Référence Part nº.	Descripción del artículo Description de l'article Description	* Cantidad Quantité Quantity	** Precio Prix Price	** Precio total Prix total Extended price
			TOTAL	
			TOTAL AMOUNT	

* Campos obligatorios / Remplissage obligatoire / Compulsory Fields
** Los precios no incluyen tasas / Taxes non comprises dans les prix / Prices before taxes

Entra en nuestra web





www.impnesa.com

Rendez-vous sur notre site web

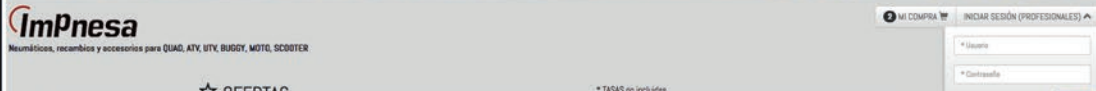
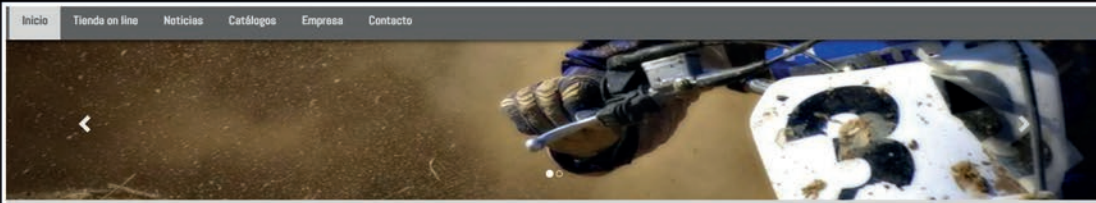

www.impnesa.fr



 **Entra tus claves: USUARIO y CONTRASEÑA**
 Si no dispones de ellas, habla con tu comercial o envíanos un email a: pedidos@impnesa.com

 **Saisissez vos identifiants: IDENTIFIANT ET MOT DE PASSE**
 Si vous n'en avez pas, consultez votre représentant commercial ou envoyez-nous un email à : commande@impnesa.fr



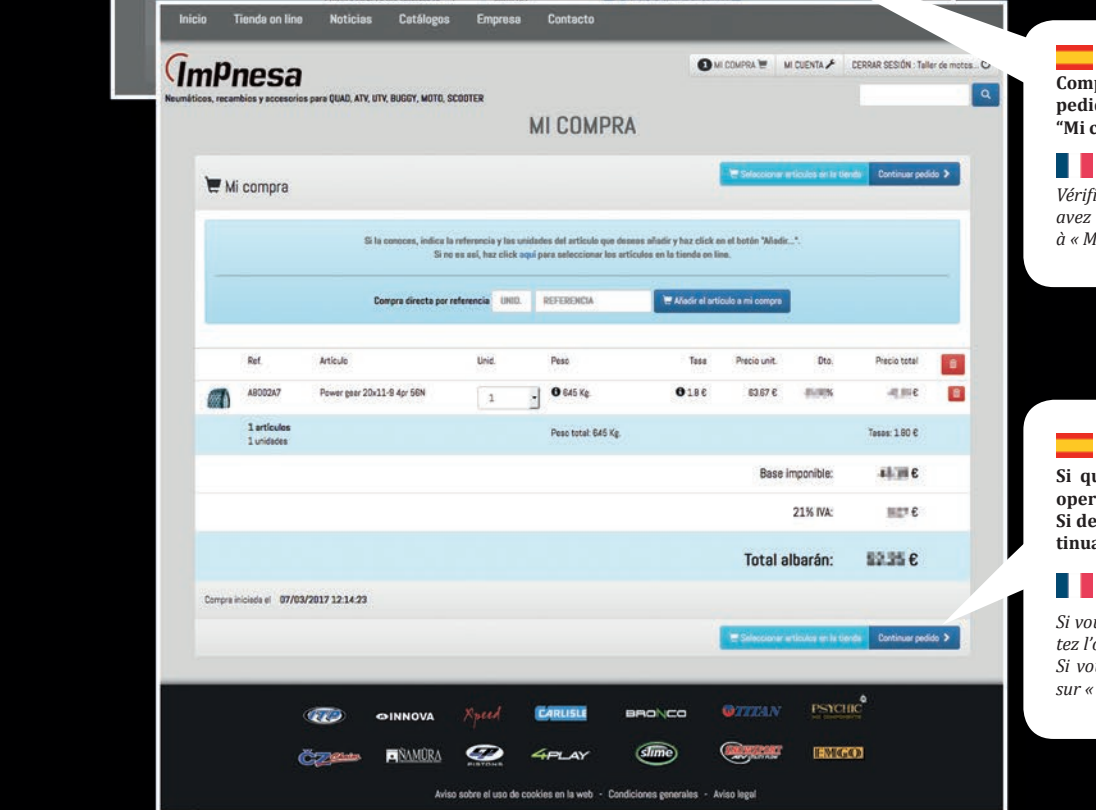

 **Introduce la cantidad de artículos que deseas y su referencia**

 **Introduisez la quantité d'articles de votre choix et leur référence**



 **Comprueba que el artículo es el que has pedido. Si es correcto añade a "Mi compra"**

 **Vérifiez que l'article est bien celui que vous avez commandé. Si tout est correct, ajoutez à « Mes achats »**

 **Si quieres seguir comprando, repite la operación. Si deseas finalizar la compra, ves a "continuar pedido"**

 **Si vous souhaitez continuer vos achats, répétez l'opération. Si vous souhaitez terminer vos achats, allez sur « continuer commande »**

Inicio Tienda on line Noticias Catálogos Empresa Contacto

Impnesa
Neumáticos, recambios y accesorios para QUAD, ATV, UTV, BUGGY, MOTO, SCOOTER

MI COMPRA MI CUENTA CERRAR SESIÓN: Taller de motos...

MI COMPRA

Mi compra > DATOS CLIENTE

DATOS FISCALES

Taller de motos S.L.
865324568

c/ Moto GP 2
15008 A CORUÑA - CORUÑA, A/LA (España)

628.123456 |
blank@blank.blank

DATOS DE ENVÍO

Taller de motos S.L.
c/ Moto GP 2
15008 - A CORUÑA (CORUÑA, A/LA) España

+ Añadir dirección de envío

Verifica que los datos fiscales y de envío sean correctos.

Vérifiez que les données fiscales et de livraison sont correctes.

Inicio Tienda on line Noticias Catálogos Empresa Contacto

Impnesa
Neumáticos, recambios y accesorios para QUAD, ATV, UTV, BUGGY, MOTO, SCOOTER

MI COMPRA MI CUENTA CERRAR SESIÓN: Taller de motos...

MI COMPRA

Mi compra > DATOS CLIENTE > CONFIRMAR PEDIDO

DATOS FISCALES

Taller de motos S.L.
865324568

c/ Moto GP 2
15008 A CORUÑA - CORUÑA, A/LA (España)

628.123456 |

DATOS DE ENVÍO

Taller de motos S.L.
c/ Moto GP 2
15008 A CORUÑA - CORUÑA, A/LA (España)

Compra iniciada el 2017-03-07 12:14:23.0 [1866]

Ref.	Artículo	Unid.	Peso	Tasa	Precio unit.	Dto.	Precio total
AB002A7	Power gear 20x11-9 4pr 68N	1.0	645 Kg.	1.8 €	63.67 €	10.37 €	81.00 €

1 artículos en el carro
1 unidades

Peso total: 645 Kg. Tasa: 1.80 €

PAGO

Tarjeta de crédito: 

Transferencia bancaria: BANCO DE SABADELL
Nº de cuenta: ES95 0081 0049 5403 0122 4125

Portes: 10.37 €
Seur: Peninsular

Base imponible: 81.00 €
21% IVA: 17.00 €

Total a pagar: 98.00 €

Añade comentarios a este pedido:

GASTOS DE ENVÍO: Peninsular

Seur hasta 7.0 Kg. 10.37 €
Halcourier hasta 7.0 Kg. 7.8 €
Sus medidas Recogido en la tienda (días laborales de 15:00 a 17:00 h.) 0 €

Realizar pago >

Escoge forma de pago y posteriormente el transporte.

Choisissez le mode de paiement puis le transport.

Realiza el pago:
Si has escogido "tarjeta", te conectarás directamente a la plataforma segura del banco "Caixabanc"

Tanto si el pago es por tarjeta o transferencia, recibirás un email de confirmación

Procédez au paiement :
Si vous avez choisi « carte bancaire », vous serez directement redirigé vers la plateforme de paiement en ligne sécurisée de la banque « Caixabanc »

Que vous ayez payé par carte ou virement bancaire, vous recevrez dans tous les cas un email de confirmation.

Comercia Global Payments

1 Selección método de pago 2 Comparación autorización 3 Solicitando autorización 4 Resultado transacción

Importe: **65,47 €**

Comercio: IMPNESA
Terminal: 322206467-1
Pedido: 00000001866
Fecha: 07/03/2017 12:15

Verified by **VISA** MasterCard SecureCode
AMERICAN EXPRESS SafeKey

PAGAR CON TARJETA

Nº Tarjeta:
Caducidad: /
Cód. Seguridad:

CANCELAR PAGAR

PAGAR CON **iupay!**



Thundra Cross y llanta SS



Ultra Cross y llanta SS



Baja Cross 8 lonas



Holeshot XCR



**Los mejores neumáticos
y llantas del mercado**



BRONCO

INNOVA

EMIGO

CZ Chains

GP
PISTONS

PSYCHIC
MX COMPONENTS

4PLAY
PERFORMANCE QUAD COMPONENTS BY BRONCO

XPEED

NAMURA
TECHNOLOGIES INC.

Asonic

ITP

SNOWSPORT
AV UTILITY PLOW

RUGGED

DEMON
POWERSPORTS

Starbrite
STAR TRON

G.P.R.
EXHAUST SYSTEM

Emax

AIRSAI

ULTIMAX
AV

BC
BORG IN ITALY

GRO
Global Racing Oil

GALFER

J.COSTA

