

OFF ROAD / QUAD-ATV / UTV



25
ANIVERSARIO
★ IMPNESA ★



2016

Impnesa

Usuario:

Clave:

HORARIO RECEPCIÓN Y ENTREGA DE PEDIDOS:

Todos los pedidos están sujetos al servicio de 24h
(48h dependiendo de la zona y fluidez de transporte de vuestra población)
Los pedidos efectuados de 9:00 a 14:00 h. La recogida se realiza a las 15:00 h.
Los pedidos efectuados de 15:00 a 18:00 h. (a partir de las 17:00 h no siempre esta garantizado su envío), se efectuara su recogida a las 18:00 h.

Hasta las 14:00 h. es posible añadir artículos al pedido, nuestra intención es ofrecerle una correcta fluidez en la realización de sus pedidos y un eficiente servicio tanto a nivel logístico y de atención.



Ventas

Toni Pulido
Queralt Pich
Ana Izquierdo

International sales

Ana Izquierdo

Consultas técnicas

Eduard Tarrés (Quad - UTV)
Toni Pulido (MX - Enduro)

Contabilidad y créditos

Marta Ortega

Dirección

C/ Narcís Monturiol, 3
Pol. Ind. Bufalvent
08243 Manresa (Barcelona)

Teléfono de contacto

(+34) 938 771 550

Fax

(+34) 938 746 850

E-mail

pedidos@impnesa.com

Tarifa válida a partir del 1 de Marzo de 2016.

I.V.A. no incluido. Tasas reciclaje no incluidas. Precios en euros.

Todos los precios y datos se consideran correctos salvo posible error de imprenta.
Los precios pueden cambiar sin previo aviso.

ÍNDICE **SECTORIAL**

MX / ENDURO

- | | |
|------------|------------------------------------------|
| 6 | Ruedas y neumáticos |
| 15 | Motor |
| 43 | Admisión / Escape / Refrigeración |
| 53 | Eléctrico |
| 61 | Suspensión dirección |
| 69 | Frenos |
| 85 | Transmisión |
| 93 | Controles y mandos |
| 113 | Chasis |

QUAD / ATV / UTV

- | | |
|------------|------------------------------------------|
| 119 | Ruedas y neumáticos |
| 137 | Motor |
| 155 | Admisión / Escape / Refrigeración |
| 167 | Eléctrico |
| 181 | Suspensión dirección |
| 191 | Frenos |
| 201 | Transmisión |
| 223 | Controles y mandos |
| 231 | Chasis |
| 243 | Accesorios y equipamiento |

TALLER

- | | |
|------------|-----------------------------------|
| 250 | Material eléctrico |
| 253 | Herramientas taller |
| 260 | Limpiadores ultrasónicos |
| 262 | Aceites, grasas y aditivos |

CONDICIONES GENERALES

ÍNDICE MX / ENDURO

Acelerador de aluminio	96	Interruptor de freno hidráulico	58	Pastillas freno sinterizadas	70-79
Aflojafiltros	40	Interruptor de freno mecánico	58	Pedales de arranque	110
Agarre cubierta	8	Interruptores de arranque	59	Pedales de cambio	111-112
Ajustador válvula escape 2t KTM	35	Interruptores de paro	59	Piñones y coronas acero	86-90
Alargo guardabarros led	60	Intruutor de embrague	58	Pipa de bujía con resistencia	56
Alicates plato embrague	35	Juego conectores macho y hembra	56	Pipas de bujía	57
Asientos completos y sus fundas	118	Juego de embudos	47	Pit Cross	7
Baterías	54	Juntas de escape	48-49	Portachiclés	47
Bielas completas	32-33	Kit bomba de agua Honda CRF 450	42	Protector cárter piñón	88
Bobina encendido	56	Kit de pistón racing CP y Juntas Cometic	16	Protector de aluminio para cárter	114-115
Brida tubo gasolina	46	Kit de piston y juntas Namura	17-25	Protector de cadena	92
Bujías NGK	57	Kit de reparación carburador	45	Protector disco freno trasero	84
Cables acelerador y embrague	98-99	Kit de reparación dirección	62-63	Protector horquilla neopreno	65
Cadenas	91	Kit discos embrague	36-37	Protector pedal de freno trasero	112
Cámaras aire reforzadas	8	Kit profesional	9	Protector piñón	92
Cañas acelerador	97	Kit repara pinchazos con bolsa	9	Protector radiador	116-117
Cargadores baterías	55	Kit repara pinchazos y recambios tiras	9	Protetor de llanta	8
Cargas CO2 16gr.	9	Kit reparación basculante	66-67	Provetas medidoras líquido	47
Centrador de cámara	8	Kit reparación bieleta	64	Puños	95
Chiclés carburador	44	Kit reparación bomba de freno	82-83	Radiadores	50-52
Cigüeñales	34	Kit reparación casquillos amortiguador trasero	68	Radios llanta	10
Cojinetes ruedas delanteras y traseras	11-14	Kit reparación de cables	97	Rascador de juntas	25
Compresor de válvulas	35	Kit retenes bomba de agua	42	Regulador corriente	56
Conector rápido gasolina	47	Kit retenes motor	35	Rejas protección radiador	52
Conmutador luces	58	Kits de cilindro MX	27	Relés de arranque	60
Control de horquilla	65	Láminas de admisión	46	Reparador válvula llanta	8
Depósito gasolina portátil 0,5l	47	Limitador velocidad y RPM	60	Rodillos cadena	91
Desmultiplicador embrague	97	Limpiador de cadena	91	Saca muelles	52
Destalonador de neumáticos	8	Limpiador de chiclés	47	Sangradores de horquilla	65
Destornillador curvo	45	Llave para radios	8	Sangradores de horquilla mini	65
Difisur temperatura radiador	52	Mando acelerador	96	Sellador	9
Discos de freno	80-81	Manetas fundición y forjadas	103-110	Separador de pistón pinza de freno	81
Disipador temperatura freno	84	Manetas plegables	101-102	Soportes de maneta embrague	100
Donuts	95	Manillares aluminio ø28	94	Talonador neumáticos	8
Elevadores manillar de aluminio	95	Mini compresor de viaje	9	Tapón drenaje imantado	41
Extractor de bulón	35	Mini corta cadenas	91	Tapón llenado aceite	41
Extractor de chiclés	45	Monta válvulas	8	Tapón silencioso	52
Extractor de retenes	34	Montador de válvulas	35	Tapones aluminio	9
Extractor de rodamientos	34	Muelles para válvulas racing	30	Testigo depósito gasolina	47
Faros halógenos	60	MX Enduro / Superenduro	7	Toma corriente	60
Fibra silencioso 1100°C	52	MX Super Cross Competition	7	Tornillo regulación aire	46
Filtro de gasolina	47	MX Super X Gear	7	Tubo gasolina NBR 5m	46
Filtros de aceite	38-40	MX Top Gear	7	Útil zapatas embrague KTM	35
Filtros de aire universales	46	Palanca neumáticos	8	Válvula tapón gasolina	47
Galgas Chiclés	45	Paramanos	94	Válvulas de admisión y escape racing	28
Grifos gasolina	46	Pastillas de reglaje	31	Varilla manillar	95
Interruptor	58				

ÍNDICE QUAD / ATV / UTV

Accesorios manillares	225	Bendix Polaris	173	Caja pastillas de reglaje	149
Acelerador de gatillo	227	Bielas completas	150-151	Calefacción manos y gatillo	226
Acelerador de puño	227	Bieleta amortiguador delant.banshee	190	Candados	246
Adaptador Filtro de potencia	161	Blackwater Evolution	123	Cardan completo	222
All Trail	126	Bobina encendido	173	Cargador baterías	171
AT 489	126	Brida tubo gasolina	158	Cargas CO2	131
Baja Cross	125	Bujías	175	Cascos	245
Baja Cross Sport	125	Cables acelerador	228-229	Casquillo variador	205
Bandeja de carga	248	Cables batería	180	Casquillos embrague Polaris	206
Banderín	247	Cables embrague	228-229	Catadiópticos	177
Baterías	168-171	Cadenas	203	Chiclés carburador	156

Cigüeñal completo	151
Cilindros STD o aumento cilindrada	145
Claxon	177
Columna dirección	182
Complementos llanta	127-128
Comprobador de batería	171
Conector rápido gasolina	159
Conmutadores	176
Coronas	202
Correas	246
Correas de variador	204
Cruceta de sujeción corona	203
Crucetas cardan	210-213
Cuchillo cutter	246
Desconectores	226
Desmultiplicador embrague	226
Destornillador curvo	158
Difusor temperatura radiador	166
Disco velocidad 45	177
Discos de freno	198
Ejes de tracción	203
Elevador manillar	225
Empuñaduras	227
Extractor de chiclés	158
Faros halógenos	180
Fibra silencioso	159
Filtro de aceite	153-154
Filtro de gasolina	159
Filtros de aire	160-161
Filtros de potencia	161
Fuelles palier	219-221
Funda bujía	175
Fundas asiento	232
Gafas	244
Galgas Chiclés	158
Gomas sujeción capó	236
Grifos gasolina	158
Guía rampa embrague Polaris	207
Holeshot ATR	123
Holeshot GNCC	121
Holeshot MXR 4/ MXR 6	120
Holeshot SR	120
Holeshot SX	120
Holeshot XCR	120
Holeshot XCT	120
Intermitentes	176
Interruptor de freno hidráulico	177
Interruptor de freno mecánico	177
Interruptores	177
Junta de embrague	152
Juntas cilindro	139-144
Juntas colector y escape	162-163
Juntas motor	139-144
Kit casquillos buje trasero	190
Kit casquillos eje	203
Kit casquillos trapecios	188
Kit casquillos trapecios y buje polaris	189
Kit casquillos trapecios y buje trasero	190
Kit cilindro con aumento cilindrada	145
Kit conexión permanente	171
Kit contrapesos variador	207
Kit de reparación carburador	157
Kit de trabajo cabrestante	248
Kit de transmisión	202
Kit embrague	152

Kit encendedor	171
Kit pistón	138-144
Kit profesional	131
Kit repara pinchazos	131
Kit reparación basculante	183
Kit reparación bieleta	183
kit reparación bomba de freno	200
Kit reparación brazo basculante trasero	190
Kit reparación cable embrague/ acelerador	226
Kit reparación dirección	182
Kit reparación motor arranque	172
kit reparación pinza de freno	199
Kit reparación variador	207
Kit reparación variador Polaris	207
Kit retenes grupo diferencial	222
Kit rodamientos ruedas/eje trasero	132-133
Kit soporte columna dirección	183
Kit tornillos recambio separadores	135
Knobby Gear	122
Land Hawk	122
Limitador velocidad y rpm	180
Limpiador de chiclés	158
Llanta SS112	126
Llantas	127-130
Luces freno	176
Luces químicas	246
Maletas	248
Manetas embrague	230
Manetas freno	230
Manillares	225
Mini compresor de viaje	131
Mini cortacadenas	202
Minipala multiuso	246
Motor arranque	172
Mud Gear	124
Mud Lite AT y XL	124
Mud Lite XTR	123
Opticas	176
Palas para nieve	249
Palier completo	214-216
Parabrisas	248
Pastillas de freno	192-197
Pastillas de reglaje	149
Pastillas de variador Polaris	205
Perno embrague arrancador	207
Petate hermético	246
Pickup	174
Piñones	202
Placas de fricción	152
Power Gear	122
Power Gear Enduro	122
Protectores aluminio	233-242
Protectores mano	224
Pulpos	246
Punteras completas	217-218
Quad cross MX PRO	120
Quad Cross XC	121
Racer	123
Radiador calefacción UTV	180
Radiadores	164
Rascador de juntas	145
Recambio cascós	244
Recambios tiras	131
Recambios variadores J.Costa	208

Redes elásticas	246
Regulador de corriente	178-179
Rejas protección radiador	166
Relés de arranque	174
Relés Intermitencia	177
Remaches plástico	236
Retenes de válvula	148
Retenes motor	151
Retrovisores	180
Rodillos cadena	202
Rodillos embrague	205
Rodillos variador	205
Rótulas barra estabilizadora	185
Rótulas dirección	184-185
Rótulas trapecios	186-187
Sacamuelles	159
Segmentos	139-144
Sellador	131
Sensor temperatura agua	165
Separadores aluminio	134-135
Separadores metálicos	136
Separadores nilón	136
Separadores para RZR	241
Separadores para Wild Cat	242
Sierra plegable	246
Soporte manillar	182
Speed Gear	122
Tapón gasolina aluminio	159
Tapón gasolina con llave	159
Tapón silencioso	159
Tapones aluminio	131
Termocontactos ventilador	166
Terracross R/T	125
Testigos luces	179
Toma corriente	180
Tope goma amortiguador	190
Tornillo aire	158
Trail Wolf	121
Tubera Carburador	158
Tubo gasolina NBR	158
Tuercas eje	203
Tundra Cross	126
Turf Tammer	121
Ultra Cross	125
Válvulas admisión/escape	146-147
Válvulas aguja de carburador	157
Variadores J.Costa	209
Vávuila tapón gasolina	159
X-100	121
X-500	122
Xtrem Lite	124

RUEDAS Y NEUMÁTICOS



INNOVA MX Enduro / Superenduro

El diseño del taco ofrece una excepcional conducción en off-road, y el diseño de la cubierta absorbe las irregularidades del terreno con total facilidad. La composición de la goma ofrece una gran durabilidad y control en la tierra.

Dimensiones	Referencia	Modelo	Índice velocidad	Peso (kg.)	P.V.P.
DELANTERAS					
● 80/100-21 (90/90-21)	A080821	3208	51R FIM	3,90	45,39
● 80/100-21 (90/90-21)	A100821	3210	51R FIM	3,90	45,39
TRASERAS					
● 120/90-18	A061218	3206	65M FIM	6,00	56,07
● 140/80-18	A061418	3206	70M FIM	6,00	66,76

● Homologado ITV



IA-3208

IA-3210

IA-3206

INNOVA MX Super X'Gear

Dimensiones	Referencia	Modelo	Índice velocidad	Peso (kg.)	P.V.P.
DELANTERAS					
80/100-21 (90/90-21)	A070821	3207	51R FIM	3,90	45,39
TRASERAS					
110/100-18	A051118	3205	64M	5,00	56,07
100/90-19	A051019	3205	57M	4,90	61,41
110/90-19	A051119	3205	62M	5,05	64,08
120/90-19	A051219	3205	66M	5,00	66,76



IA-3207

IA-3205

INNOVA MX Super Cross Competition

Dimensiones	Referencia	Modelo	Índice velocidad	Peso (kg.)	P.V.P.
DELANTERAS					
80/100-21 (90/90-21)	A090821	3209	51R	3,90	45,39
TRASERAS					
110/100-18	A041118	3204	64M	5,00	56,07



IA-3209

IA-3204

INNOVA MX Top Gear

Dimensiones	Referencia	Modelo	Índice velocidad	Peso (kg.)	P.V.P.
DELANTERAS					
80/100-21	A300821	3015	51M	3,55	39,56
TRASERAS					
100/100-18	A301018	3014	60M	5,45	52,82
110/100-18	A301118	3014	64M	5,65	57,46
120/100-18	A301218	3014	68M	5,65	62,07
100/90-19	A301019	3014	57M	5,35	51,31
110/90-19	A301119	3014	62M	6,00	55,93



IA-3015

IA-3014

INNOVA Pit Cross

Dimensiones	Referencia	Modelo	Índice Velocidad	Peso (kg.)	P.V.P.
60/100-10 (2.50-10)	A326010	IA-3203	33J	1,55	16,02
70/100-10 (2.75-10)	A327010	IA-3203	38J	1,55	21,36
60/100-12 (2.50-12)	A326012	IA-3203	4PR	1,85	22,16
80/100-12 (3.00-12)	A328012	IA-3203	50M	2,3	26,70
60/100-14 (2.50-14)	A326014	IA-3202	30M	1,7	24,42
90/100-16	A329016	IA-3203	51M		40,05
70/100-19	A327019	IA-3203	42M		34,71



IA-3202

IA-3203

● Homologado ITV

Los neumáticos que no tengan el punto ● no pueden utilizarse para asfalto

RUEDAS Y NEUMÁTICOS

XPEED Protector de llanta

Protege la cámara de los radios. El protector tiene un ancho de 22 mm. Se suministra en paquetes de 1 unidad o 10 unidades.

Referencia	Descripción	P.V.P.
DMC06358A	1 Protector para llanta de 14"	3,62
DMC06358	10 Protectores para llanta de 14"	14,46
DMC063581A	1 Protector para llanta de 15"	3,62
DMC063581	10 Protectores para llanta de 15"	14,46
DMC063582A	1 Protector para llanta de 16"	3,62
DMC063582	10 Protectores para llanta de 16"	14,46
DMC063583A	1 Protector para llanta de 17"	3,62
DMC063583	10 Protectores para llanta de 17"	14,46
DMC063584A	1 Protector para llanta de 18"	3,62
DMC063584	10 Protectores para llanta de 18"	14,46
DMC063585A	1 Protector para llanta de 19"	3,62
DMC063585	10 Protectores para llanta de 19"	14,46
DMC063587A	1 Protector para llanta de 21"	3,62
DMC063587	10 Protectores para llanta de 21"	14,46



WAYCOM Cámaras aire reforzadas

Referencia	Descripción	P.V.P.
CM9026	2,50/2,75-10 70/100-10	10,75
CM9029	3,25/3,50-14 90/100-14	12,42
CM9030	3,25/3,50-16 90/100-16	13,25
CM9031	2,25/2,50-17 70/100-17	13,25
CM9034	4,25/4,50-18 140/80-18	17,42
CM9035	2,75/3,00-19 70/100-19	14,58
CM9041	4,00/4,10-19 100/90-19	16,58
CM9037	4,25/4,50-19 110/100-19	17,42
CM9038	2,75/3,00-21 80/100-21	15,75
CM9042	3,00/3,25/21 90/90-21	16,25



XPEED Agarre cubierta

Referencia	Descripción	P.V.P.
DMC06300B	Ancho 1,60"	6,30
DMC06301B	Ancho 1,85"	6,30
DMC06302B	Ancho 2,15"	6,70
DMC06312B	Ancho 2,50"	6,70

Palanca neumáticos

Referencia	Descripción	P.V.P.
D130020	Largo 40cm	9,10
D1300161	Largo 22cm	6,35
D130023	Largo 38cm	10,32
DMX12100	Largo 26cm	10,28



Talonador de neumáticos

Referencia	P.V.P.
DUP12051	4,84

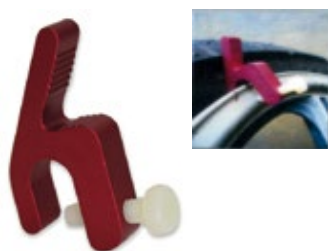

Centrador de cámara

Referencia	P.V.P.
DUP12037	7,65



Monta válvulas

Referencia	P.V.P.
DUP12058	9,48



Destalonador de neumáticos

Referencia	P.V.P.
DMX12041	15,34



Llave para radios

Referencia	P.V.P.
D130022	7,28



Reparador válvula llanta

Referencia	Descripción	P.V.P.
DUP12064	Tipo A	3,80
DUP12046	Tipo B	6,12

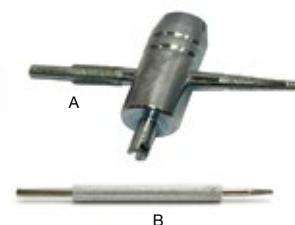

Cantidades



< 75 Km/h

$\emptyset(\text{cm}) \times \text{An} (\text{cm}) \times 0,55 = \text{ml}$

> 75 Km/h

$\emptyset(\text{cm}) \times \text{An} (\text{cm}) \times 0,3 = \text{ml}$



Ejemplo:

Speed Gear Quad
21x7-10

$53\emptyset \times 18\text{An} \times 0,3 = 315 \text{ ml slime}$



Sellador

Referencia	Descripción	P.V.P.
DUP12216	250 ml	4,65
DUP122162	473 ml	8,32



Mini compresor de viaje

El kit Slime incluye:

- Un compresor con manómetro y conexiones.
- Mazo de cableado principal con fusible.
- Manguito aire.
- Pinzas de batería.
- Precableado directo a batería.

Referencia	Peso (kg)	Dimensiones (cm)	P.V.P.
S40006	0,95	15X16X6	42,12



XPEED 3 Cargas CO2 16gr.

Referencia	P.V.P.
X30501	8,00



BRONCO Kit repara pinchazos con bolsa

Referencia	P.V.P.
DAT12208	19,75



4 Tapones aluminio



PLATA

AZUL

Referencia	P.V.P.	Referencia	P.V.P.
S1020	5,80	S1018	5,80



Kit repara pinchazos y recambios tiras

Referencia	Descripción	P.V.P.
DUP12307A	Recambio 10 mechas	4,13
S21032	Kit repara pinchazos	7,20

DUP12307A

S21032



Kit profesional



Referencia	P.V.P.
S2510	20,71

RUEDAS Y NEUMÁTICOS



Radios llanta

Se entregan de dos maneras: juego completo de radios, o radio por separado (tuercas incluidas).



		KIT COMPLETO			1 RADIO "LARGO"		1 RADIO "CORTO"	
HONDA	Año	Llanta	Referencia	P.V.P.	Referencia	P.V.P.	Referencia	P.V.P.
CR 125	95-13	21"	DMX06032	58,41	DMX060321	1,79		
CR 125	89-13	18"	DMX06045	58,00	DMX060451	1,79	DMX060452	1,79
CR 125	89-13	19"	DMX06031	56,27	DMX060311	1,79	DMX060312	1,79
CR 250 R	95-13	21"	DMX06032	58,41	DMX060321	1,79		
CR 250 R	89-13	18"	DMX06045	58,00	DMX060451	1,79	DMX060452	1,79
CR 250 R	89-13	19"	DMX06031	56,27	DMX060311	1,79	DMX060312	1,79
CRF 250 R	95-13	21"	DMX06032	58,41	DMX060321	1,79		
CRF 250 R	89-13	18"	DMX06045	58,00	DMX060451	1,79	DMX060452	1,79
CRF 250 R	89-13	19"	DMX06031	56,27	DMX060311	1,79	DMX060312	1,79
XR 400	89-11	21"	DMX06046	58,62	DMX060461	1,79		
CRF 450 R	95-13	21"	DMX06032	58,41	DMX060321	1,79		
CRF 450 R	89-13	19"	DMX06031	56,27	DMX060311	1,79	DMX060312	1,79
CRF 450 X	95-13	21"	DMX06032	58,41	DMX060321	1,79		
CRF 450 X	89-13	18"	DMX06045	58,00	DMX060451	1,79	DMX060452	1,79
XR 600	89-11	21"	DMX06046	58,41	DMX060461	1,79		
XR 600	89-09	18"	DMX06030	57,70	DMX060301	1,79	DMX060302	1,79
XR 650 R	89-11	21"	DMX06046	58,41	DMX060461	1,79		
XR 650 R	89-09	18"	DMX06030	57,70	DMX060301	1,79	DMX060302	1,79

		KIT COMPLETO			1 RADIO "LARGO"		1 RADIO "CORTO"	
KAWASAKI	Año	Llanta	Referencia	P.V.P.	Referencia	P.V.P.	Referencia	P.V.P.
KX 125	99-08	21"	DMX06034	57,59	DMX060341	1,79		
KX 125	99-13	19"	DMX06033	63,32	DMX060331	1,89	DMX060332	1,89
KX 250	99-08	21"	DMX06034	57,59	DMX060341	1,79		
KX 250	99-13	19"	DMX06033	63,32	DMX060331	1,89	DMX060332	1,89
KX 250 F	04-05	21"	DMX06034	57,59	DMX060341	1,79		
KX 250 F	99-13	19"	DMX06033	63,32	DMX060331	1,89	DMX060332	1,89
KLX 450 X	06-13	21"	DMX06035	56,67	DMX060351	1,79		
KX 450 F	06-13	21"	DMX06035	56,67	DMX060351	1,79		
KX 450 F	99-13	19"	DMX06033	63,32	DMX060331	1,89	DMX060332	1,89

		KIT COMPLETO			1 RADIO "LARGO"		1 RADIO "CORTO"	
KTM	Año	Llanta	Referencia	P.V.P.	Referencia	P.V.P.	Referencia	P.V.P.
EXC todas	98-14	21"	DMX06037	65,37	DMX060371	1,99		
MXC todas	98-14	21"	DMX06037	65,37	DMX060371	1,99		
SX todas	98-14	21"	DMX06037	65,37	DMX060371	1,99		
XC todas	98-14	21"	DMX06037	65,37	DMX060371	1,99		
EXC - XC -SX todas	96-16	18"	DMX06051	61,91	DMX060511	1,89	DMX060512	1,89
SX todas	98-14	19"	DMX06036	62,91	DMX060361	1,89	DMX060362	1,89

		KIT COMPLETO			1 RADIO "LARGO"		1 RADIO "CORTO"	
SUZUKI	Año	Llanta	Referencia	P.V.P.	Referencia	P.V.P.	Referencia	P.V.P.
RM 125	86-09	21"	DMX06039	57,59	DMX060391	1,79		
RM 125	86-09	19"	DMX06038	62,91	DMX060381	1,89	DMX060382	1,89
RM 250	86-09	21"	DMX06039	57,59	DMX060391	1,79		
RM 250	86-09	19"	DMX06038	62,91	DMX060381	1,89	DMX060382	1,89
RMZ 250	04-06	21"	DMX06034	57,59	DMX060341	1,79		
RMZ 250	04-06	19"	DMX06033	63,32	DMX060331	1,89	DMX060332	1,89
RMZ 250	07-14	21"	DMX06041	58,62	DMX060411	1,79		
RMZ 250	07-13	19"	DMX06040	62,91	DMX060401	1,89	DMX060402	1,89
DR-Z 400	00-09	18"	DMX06054	64,91	DMX060541	1,89	DMX060542	1,89
RMZ450	05-13	21"	DMX06041	58,62	DMX060411	1,79		
RMZ450	07-14	19"	DMX06040	62,91	DMX060401	1,89	DMX060402	1,89

		KIT COMPLETO			1 RADIO "LARGO"		1 RADIO "CORTO"	
YAMAHA	Año	Llanta	Referencia	P.V.P.	Referencia	P.V.P.	Referencia	P.V.P.
WR todas	02-14	21"	DMX06044	57,59	DMX060441	1,79		
WR todas	99-14	18"	DMX06042	61,48	DMX060421	1,89	DMX060422	1,89
YZ todas	02-14	21"	DMX06044	57,59	DMX060441	1,79		
YZ todas	99-14	18"	DMX06042	61,48	DMX060421	1,89	DMX060422	1,89
YZ todas	99-14	19"	DMX06043	68,34	DMX060431	1,99	DMX060432	1,99
YZF todas	02-14	21"	DMX06044	57,59	DMX060441	1,79		
YZF todas	99-14	18"	DMX06042	61,48	DMX060421	1,89	DMX060422	1,89
YZF todas	99-14	19"	DMX06043	68,34	DMX060431	1,99	DMX060432	1,99



Cojinetes ruedas delanteras y traseras



RUEDAS Y NEUMÁTICOS

MOTOR

ADMISIÓN / ESCAPE REFRIGERACIÓN

ELECTRICO

SUSPENSIÓN / DIRECCIÓN

FRENOS

TRANSMISIÓN

CONTROLES Y MANDOS

CHASIS

ACCESORIOS

APRILIA	Año	Delanteros	P.V.P.	Traseros	P.V.P.
RXV 450	06-08			DMX06238	20,40
SXV 450	06-08			DMX06238	20,40
RXV 550	06-08			DMX06238	20,40
SXV 550	06-08			DMX06238	20,40

BETA	Año	Delanteros	P.V.P.	Traseros	P.V.P.
250 EVO 2T	2014	DMX06223	18,79		
350 RR 4T	11-14	DMX06223	18,79		
400 RR 4T	05-14	DMX06223	18,79		
450 RR 4T	05-14	DMX06223	18,79		
500 RR 4T	13-14	DMX06223	18,79		
520 RR 4T	10-11	DMX06223	18,79		
525 RR 4T	05-09	DMX06223	18,79		

GAS GAS	Año	Delanteros	P.V.P.	Traseros	P.V.P.
EC 50 ROOKIE	04-05	DMX06220	20,40	DMX06220	20,40
SM 50 ROOKIE	04-05	DMX06220	20,40	DMX06220	20,40
EC 125	2003			DMX06262	31,06
EC 125	04-09	DMX06258	18,66	DMX06262	31,06
MC 125	2003			DMX06262	31,06
MC 125	04-09	DMX06258	18,66	DMX06262	31,06
SM 125	03-09			DMX06262	31,06
PAMPERA 125	02-05	DMX06220	20,40	DMX06220	20,40
EC 200	2003			DMX06262	31,06
EC 200	04-09	DMX06258	18,66	DMX06262	31,06
EC 250	2003			DMX06262	31,06
EC 250	04-09	DMX06258	18,66	DMX06262	31,06
MC 250	2003			DMX06262	31,06
MC 250	04-09	DMX06258	18,66	DMX06262	31,06
SM 250	03-05			DMX06262	31,06
PAMPERA 250	02-05	DMX06220	20,40	DMX06220	20,40
PAMPERA 280	02-05	DMX06220	20,40	DMX06220	20,40
EC 300	2003	DMX06258	18,66	DMX06262	31,06
EC 300	04-09	DMX06258	18,66	DMX06262	31,06
EC 450 FSE	03-06	DMX06258	18,66	DMX06262	31,06
EC 450 FSR	07-09	DMX06258	18,66	DMX06262	31,06
MC 450 FSR	2007	DMX06258	18,66	DMX06262	31,06
PAMPERA 450	2007	DMX06258	18,66	DMX06262	31,06
SM 450 FSE	04-05	DMX06258	18,66	DMX06262	31,06
SM 450 FSR	07-09	DMX06258	18,66	DMX06262	31,06

HONDA	Año	Delanteros	P.V.P.	Traseros	P.V.P.
CRF 50 F	04-12	DMX06202	19,16	DMX06203	23,37
XR 50 R	00-03	DMX06202	19,16	DMX06203	23,37
CRF 70 F	04-12	DMX06202	19,16	DMX06204	17,55
XR 70 R	97-03	DMX06202	19,16	DMX06204	17,55
CR 80 R	83-85	DMX06202	19,16	DMX06204	17,55
CR 80 R	86-91	DMX06202	19,16		
CR 80 R	92-02	DMX06202	19,16	DMX06205	17,48
CR 80 RB	90-91	DMX06202	19,16		
CR 80 RB	92-95	DMX06202	19,16	DMX06205	17,48
CRF 80 F	04-13	DMX06202	19,16	DMX06204	17,55
XR 80	85-03	DMX06202	19,16	DMX06204	17,55
CR 85 R	03-07	DMX06202	19,16	DMX06205	17,48
CRF 100 F	04-13	DMX06202	19,16	DMX06204	17,55
XR 100 R	85-03	DMX06202	19,16	DMX06204	17,55
CRF 110 F	13-14	DMX06202	19,16		
CR 125 R	83-84			DMX06206	21,64
CR 125 R	85-86	DMX06206	21,64	DMX06206	21,64
CR 125 R	87-89	DMX06206	21,64		
CR 125 R	90-94	DMX06206	21,64	DMX06207	21,40
CR 125 R	95-99	DMX06209	24,31	DMX06207	21,40

CR 125 R	00-07	DMX06209	24,31	DMX06208	20,52
CRF 125	2014	DMX06202	19,16	DMX06604	17,55
CRF 150 F	03-14	DMX06210	20,15	DMX06211	23,37
CRF 150 R	07-14	DMX06248	20,77	DMX06249	25,85
CRF 150 RB	07-14	DMX06248	20,77	DMX06249	25,85
XR 200 R	81-82			DMX06212	23,87
XL 200 R	83-84			DMX06212	23,87
CRF 230 F	03-14	DMX06210	20,15	DMX06211	23,37
CR 250 R	85-89	DMX06206	21,64		
CR 250 R	90-94	DMX06206	21,64	DMX06207	21,40
CR 250 R	95-99	DMX06209	24,31	DMX06207	21,40
CR 250 R	00-07	DMX06209	24,31	DMX06208	20,52
CRF 250 R	04-14	DMX06209	24,31	DMX06208	20,52
CRF 250 X	04-13	DMX06264	30,13	DMX06208	20,52
XR 250 R	92-95	DMX06241	20,52		
XR 250 R	96-04	DMX06241	20,52	DMX06242	23,87
XR 250 R	84-85			DMX06212	23,87
XR 350 R	83-84			DMX06212	23,87
XR 400 R	96-04	DMX06243	21,51	DMX06242	23,87
CRF 450 R	02-14	DMX06209	24,31	DMX06208	20,52
CRF 450 X	05-14	DMX06264	30,13	DMX06208	20,52
CR 500 R	85-89	DMX06206	21,64		
CR 500 R	90-94	DMX06206	21,64	DMX06207	21,40
CR 500 R	95-01	DMX06209	24,31	DMX06207	21,40
XR 600 R	93-00	DMX06243	21,51		
XR 650 L	93-13	DMX06243	21,51	DMX06212	23,87
XR 650 R	00-07	DMX06243	21,51		
XR 650 R	00-07	DMX06243	21,51		

HUSABERG	Año	Delanteros	P.V.P.	Traseros	P.V.P.
FE 250	13-14	DMX06223	18,79	DMX06247	17,48
TE 250	11-14	DMX06223	18,79	DMX06247	17,48
TE 300	11-14	DMX06223	18,79	DMX06247	17,48
FE 350	2013	DMX06223	18,79	DMX06247	17,48
FE 390	10-11	DMX06223	18,79	DMX06247	17,48
FC 450	04-05	DMX06223	18,79	DMX06247	17,48
FE 450	04-14	DMX06223	18,79	DMX06247	17,48
FS 450	2004	DMX06223	18,79	DMX06247	17,48
FX 450	10-11	DMX06223	18,79	DMX06247	17,48
FS-C 450	05-06	DMX06223	18,79	DMX06247	17,48
FS-E 450	05-08	DMX06223	18,79	DMX06247	17,48
FE 501	13-14	DMX06223	18,79	DMX06247	17,48
FE 550	07-08	DMX06223	18,79	DMX06247	17,48
FS-E 550	2007	DMX06223	18,79	DMX06247	17,48
FE 570	09-11	DMX06223	18,79	DMX06247	17,48
FS 570	09-11	DMX06223	18,79	DMX06247	17,48
FC 650	04-05	DMX06223	18,79	DMX06247	17,48
FE 650	04-08	DMX06223	18,79	DMX06247	17,48
FS 650	04-08	DMX06223	18,79	DMX06247	17,48
FS-C 650	05-06	DMX06223	18,79	DMX06247	17,48
FS-E 650	05-07	DMX06223	18,79	DMX06247	17,48

HUSQVARNA	Año	Delanteros	P.V.P.	Traseros	P.V.P.
CR 125	01-13	DMX06259	18,91		
WR 125	02-13	DMX06259	18,91		
CR 250	01-04	DMX06259	18,91		
TC 250	03-11	DMX06259	18,91		
TE 250	03-11	DMX06259	18,91		
TXC 250	08-11	DMX06259	18,91		
WR 250	03-13	DMX06259	18,91		
WR 300	08-13	DMX06259	18,91		
TE 310	09-11	DMX06259	18,91		
SMR 450	04-09	DMX06259	18,91		
TC 450	03-10	DMX06259	18,91		

RUEDAS Y NEUMÁTICOS



Cojinetes ruedas delanteras y traseras



Modelo	Año	DMX	P.V.P.
TE 450	03-10	DMX06259	18,91
TXC 450	08-10	DMX06259	18,91
SM 510	2010	DMX06259	18,91
SMR 510	04-09	DMX06259	18,91
TC 510	05-09	DMX06259	18,91
TE 510	04-10	DMX06259	18,91
TXC 510	08-10	DMX06259	18,91
SM 610	06-08	DMX06259	18,91
SMR 610	04-09	DMX06259	18,91
TC 610	2001	DMX06259	18,91
TE 610	06-08	DMX06259	18,91
SMS 610	10-11	DMX06259	18,91
TE 630	10-11	DMX06259	18,91

KAWASAKI	Año	Delanteros	P.V.P.	Traseros	P.V.P.
KX 60	83-03			DMX06213	25,36
KX 65	00-14	DMX06213	25,36	DMX06213	25,36
KV 75	71-80	DMX06203	23,37	DMX06203	23,37
KD 80	88-90	DMX06203	23,37	DMX06203	23,37
KDX 80	84-88			DMX06203	23,37
KX 80	83-85			DMX06203	23,37
KX 80	98-00	DMX06203	23,37	DMX06214	17,05
KX 85	01-14	DMX06213	25,36	DMX06214	17,05
KX 100	98-14	DMX06213	25,36	DMX06214	17,05
KLX 110	02-12	DMX06239	18,17	DMX06240	26,72
KLX 125	03-09			DMX06213	25,36
KLX 125 L	03-06			DMX06213	25,36
KX 125	86-92	DMX06216	22,01	DMX06217	16,43
KX 125	93-96	DMX06218	18,79	DMX06217	16,43
KX 125	97-02	DMX06218	18,79	DMX06219	18,29
KX 125	03-05	DMX06218	18,79	DMX06238	20,40
KLX 200	08-14			DMX06214	17,05
KDX 200	89-06	DMX06265	10,73	DMX06217	16,43
KDX 220	97-05	DMX06265	10,73	DMX06217	16,43
KDX 250	91-94	DMX06265	10,73	DMX06217	16,43
KLX 250	94-96	DMX06265	10,73	DMX06217	16,43
KLX 250	06-07	DMX06265	10,73	DMX06217	16,43
KX 250	86-92	DMX06216	22,01	DMX06217	16,43
KX 250	1993	DMX06218	18,79	DMX06217	16,43
KX 250	94-95	DMX06218	18,79	DMX06217	16,43
KX 250	1996	DMX06218	18,79	DMX06217	16,43
KX 250	1997	DMX06218	18,79	DMX06219	18,29
KX 250	1998	DMX06218	18,79	DMX06219	18,29
KX 250	99-02	DMX06218	18,79	DMX06219	18,29
KX 250	03-07	DMX06218	18,79	DMX06238	20,40
KX 250 F	04-14	DMX06218	18,79	DMX06238	20,40
KLX 300 R	97-07	DMX06265	10,73	DMX06217	16,43
KLX 400	03-05	DMX06218	18,79	DMX06236	30,44
KX 450 F	06-14	DMX06218	18,79	DMX06238	20,40
KLX 450 R	08-10	DMX06218	18,79	DMX06238	20,40
KX 500	86-93	DMX06216	22,01	DMX06217	16,43
KX 500	94-96	DMX06218	18,79	DMX06217	16,43
KX 500	97-04	DMX06218	18,79	DMX06219	18,29

KTM	Año	Delanteros	P.V.P.	Traseros	P.V.P.
60 SX	98-00	DMX06220	20,40		
65 SX	98-14	DMX06220	20,40		
65 XC	98-14	DMX06220	20,40		
85 SX	03-07	DMX06253	29,45	DMX06247	17,48
85 SX	08-11	DMX06221	21,33	DMX06247	17,48

85 XC	03-11	DMX06221	21,33	DMX06247	17,48
105 SX	06-11	DMX06221	21,33	DMX06247	17,48
125 DXC	88-91	DMX06221	21,33	DMX06247	17,48
125 EGS	88-91	DMX06221	21,33	DMX06247	17,48
125 Enduro	88-90	DMX06221	21,33	DMX06247	17,48
125 EXS	93-02			DMX06247	17,48
125 EXC	03-09	DMX06223	18,79	DMX06247	17,48
125 MX	88-91	DMX06221	21,33	DMX06247	17,48
125 MX	93-99	DMX06221	21,33	DMX06222	17,55
125 MX	00-02	DMX06209	24,31	DMX06247	17,48
125 MXC	93-99			DMX06247	17,48
125 MXC	00-02	DMX06222	17,55	DMX06247	17,48
125 MXC	03-05	DMX06223	18,79	DMX06247	17,48
125 SX	93-97	DMX06221	21,33	DMX06222	17,55
125 SX	98-99	DMX06253	29,45	DMX06222	17,55
125 SX	00-02	DMX06209	24,31	DMX06247	17,48
125 SX	03-14	DMX06223	18,79	DMX06247	17,48
144 SX	07-08	DMX06223	18,79	DMX06247	17,48
150 SX	09-14	DMX06223	18,79	DMX06247	17,48
150 XC	10-14	DMX06223	18,79	DMX06247	17,48
200 EGS	98-99			DMX06247	17,48
200 EXC	98-99			DMX06247	17,48
200 EXC	00-02	DMX06222	17,55	DMX06247	17,48
200 EXC	03-05	DMX06223	18,79	DMX06247	17,48
200 MX	98-99	DMX06221	21,33	DMX06247	17,48
200 MX	00-02	DMX06209	24,31	DMX06247	17,48
200 MXC	98-99			DMX06247	17,48
200 MXC	00-02	DMX06222	17,55	DMX06247	17,48
200 MXC	03-05	DMX06223	18,79	DMX06247	17,48
200 SX	98-99	DMX06253	29,45	DMX06247	17,48
200 SX	00-02	DMX06209	24,31	DMX06247	17,48
200 SX	03-05	DMX06223	18,79	DMX06247	17,48
200 XC	06-11	DMX06223	18,79	DMX06247	17,48
200 XCW	06-11	DMX06223	18,79	DMX06247	17,48
240 Enduro	88-89	DMX06220	20,40		
240 MX	88-89	DMX06220	20,40		
250 DXC	88-90	DMX06220	20,40		
250 DXC	1991	DMX06221	21,33	DMX06247	17,48
250 EGS	88-90	DMX06220	20,40		
250 EGS	1991	DMX06221	21,33	DMX06247	17,48
250 EGS	93-99			DMX06247	17,48
250 EXC	88-90	DMX06220	20,40		
250 EXC	1991	DMX06221	21,33	DMX06247	17,48
250 EXC	93-99			DMX06247	17,48
250 EXC	00-02	DMX06222	17,55	DMX06247	17,48
250 EXC	03-09	DMX06223	18,79	DMX06247	17,48
250 MX	93-99	DMX06221	21,33	DMX06247	17,48
250 MX	00-02	DMX06209	24,31	DMX06247	17,48
250 MXC	88-90	DMX06220	20,40		
250 MXC	1991	DMX06221	21,33	DMX06247	17,48
250 MXC	93-99			DMX06247	17,48
250 MXC	00-02	DMX06222	17,55	DMX06247	17,48
250 MXC	03-09	DMX06223	18,79	DMX06247	17,48
250 SX	93-97	DMX06221	21,33	DMX06247	17,48
250 SX	98-99	DMX06253	29,45	DMX06247	17,48
250 SX	00-02	DMX06209	24,31	DMX06247	17,48
250 SX	03-14	DMX06223	18,79	DMX06247	17,48
250 SXF	05-14	DMX06223	18,79	DMX06247	17,48
250 XC	06-14	DMX06223	18,79	DMX06247	17,48



Cojinetes ruedas delanteras y traseras

Solo para kits KTM

Si añades una "P" al final de estas referencias el kit será con tubo separador

KIT NORMAL		KIT CON SEPARADOR	
DMX06221	21,33€	DMX06221P	33,00€
DMX06222	17,55€	DMX06222P	33,00€
DMX06223	18,79€	DMX06223P	33,00€
DMX06247	17,48€	DMX06247P	33,00€



250 XCF	07-09	DMX06223	18,79	DMX06247	17,48
250 XCFW	06-14	DMX06223	18,79	DMX06247	17,48
250 XCW	06-14	DMX06223	18,79	DMX06247	17,48
300 DXC	1990	DMX06220	20,40		
300 EGS	1990	DMX06220	20,40		
300 EGS	1991	DMX06221	21,33	DMX06247	17,48
300 EGS	93-99			DMX06247	17,48
300 EXC	1990	DMX06220	20,40		
300 EXC	1991	DMX06221	21,33	DMX06247	17,48
300 EXC	93-99			DMX06247	17,48
300 EXC	00-02	DMX06222	17,55	DMX06247	17,48
300 EXC	03-05	DMX06223	18,79	DMX06247	17,48
300 MX	93-99	DMX06221	21,33	DMX06247	17,48
300 MX	00-02	DMX06209	24,31	DMX06247	17,48
300 MXC	1990	DMX06220	20,40		
300 MXC	1991	DMX06221	21,33	DMX06247	17,48
300 MXC	93-99			DMX06247	17,48
300 MXC	00-02	DMX06222	17,55	DMX06247	17,48
300 MXC	03-05	DMX06223	18,79	DMX06247	17,48
300 SX	93-97	DMX06221	21,33	DMX06247	17,48
300 SX	98-99	DMX06253	29,45	DMX06247	17,48
300 SX	00-02	DMX06209	24,31	DMX06247	17,48
300 SX	03-05	DMX06223	18,79	DMX06247	17,48
300 XC	06-14	DMX06223	18,79	DMX06247	17,48
300 XCW	06-14	DMX06223	18,79	DMX06247	17,48
350 DXC	90-91	DMX06221	21,33	DMX06247	17,48
350 EGS	90-91	DMX06221	21,33	DMX06247	17,48
350 EXC	90-91	DMX06221	21,33	DMX06247	17,48
350 MX	90-91	DMX06221	21,33	DMX06247	17,48
350 SX-F	11-14	DMX06223	18,79	DMX06247	17,48
360 EGS	96-97			DMX06247	17,48
360 EXC	96-97			DMX06247	17,48
360 MXC	96-97			DMX06247	17,48
360 SX	96-97	DMX06221	21,33	DMX06247	17,48
380 EGS	98-99			DMX06247	17,48
380 EXC	98-99			DMX06247	17,48
380 EXC	00-02	DMX06222	17,55	DMX06247	17,48
380 MX	98-99	DMX06221	21,33	DMX06247	17,48
380 MX	00-02	DMX06209	24,31	DMX06247	17,48
380 MXC	98-99			DMX06247	17,48
380 MXC	00-02	DMX06222	17,55	DMX06247	17,48
380 SX	98-99	DMX06253	29,45	DMX06247	17,48
380 SX	00-02	DMX06209	24,31	DMX06247	17,48
400 EXC	00-02	DMX06222	17,55	DMX06247	17,48
400 EXC Racing	04-05	DMX06222	17,55	DMX06247	17,48
400 EXC-G	2006	DMX06223	18,79	DMX06247	17,48
400 LC4	94-99			DMX06247	17,48
400 RXC	94-99			DMX06247	17,48
400 Competition	94-99			DMX06247	17,48
400 MX	97-99	DMX06221	21,33	DMX06247	17,48
400 MX	00-02	DMX06209	24,31	DMX06247	17,48
400 MXC	00-02	DMX06222	17,55	DMX06247	17,48
400 SC	96-99			DMX06247	17,48
400 SX	97-99	DMX06221	21,33	DMX06247	17,48
400 SX	00-02	DMX06209	24,31	DMX06247	17,48
400 SXC	96-99			DMX06247	17,48
400 SXC	00-02	DMX06222	17,55	DMX06247	17,48
400 XCW	07-10	DMX06223	18,79	DMX06247	17,48
440 EXC	1995			DMX06247	17,48

440 MXC	1994	DMX06221	21,33	DMX06247	17,48
440 SX	1994	DMX06221	21,33	DMX06247	17,48
450 EXC	03-11	DMX06223	18,79	DMX06247	17,48
450 EXC-G	03-07	DMX06223	18,79	DMX06247	17,48
450 EXC Racing (#)	04-05	DMX06223	18,79	DMX06247	17,48
450 EXC-R	2008	DMX06223	18,79	DMX06247	17,48
450 MXC	03-07	DMX06223	18,79	DMX06247	17,48
450 MXC-G	03-07	DMX06223	18,79	DMX06247	17,48
450 SX	03-13	DMX06223	18,79	DMX06247	17,48
450 SX-F	03-11	DMX06223	18,79	DMX06247	17,48
450 XC	04-07	DMX06223	18,79		
450 XCW	07-14	DMX06223	18,79	DMX06247	17,48
500 DXC	1990	DMX06220	20,40		
500 DXC	1992	DMX06221	21,33	DMX06247	17,48
500 EGS	1990	DMX06220	20,40		
500 EXC	1990	DMX06220	20,40		
500 EXC	1992	DMX06221	21,33	DMX06247	17,48
500 EXC	1995			DMX06247	17,48
520 EXC	2000	DMX06222	17,55		
520 EXC	01-02	DMX06222	17,55	DMX06247	17,48
500 LC4	1991	DMX06221	21,33		
500 MX	1990	DMX06220	20,40		
500 MX	1992	DMX06221	21,33	DMX06247	17,48
500 MX	1993	DMX06221	21,33	DMX06247	17,48
500 MXC	1993	DMX06221	21,33	DMX06247	17,48
505 SXF	2008	DMX06223	18,79	DMX06247	17,48
505 XCF	08-09	DMX06223	18,79	DMX06247	17,48
520 MX	01-02	DMX06209	24,31	DMX06247	17,48
520 MXC	2000	DMX06222	17,55		
520 MXC	01-02	DMX06222	17,55	DMX06247	17,48
520 SX	01-02	DMX06209	24,31	DMX06247	17,48
525 EXC	03-05	DMX06223	18,79	DMX06247	17,48
525 EXC-G	03-05	DMX06223	18,79	DMX06247	17,48
525 MXC	03-05	DMX06223	18,79	DMX06247	17,48
525 SX	03-14	DMX06223	18,79	DMX06247	17,48
525 SMR	03-14	DMX06223	18,79	DMX06247	17,48
525 XC	06-07	DMX06223	18,79	DMX06247	17,48
525 XCW	2007	DMX06223	18,79		
530 EXC	10-11	DMX06223	18,79	DMX06247	17,48
530 EXC-R	08-09	DMX06223	18,79	DMX06247	17,48
530 XCW	08-09	DMX06223	18,79	DMX06247	17,48
540 DXC	1990	DMX06223	18,79		
540 DXC	1991	DMX06221	21,33	DMX06247	17,48
540 EGS	1990	DMX06223	18,79		
540 EGS	1991	DMX06221	21,33	DMX06247	17,48
540 EXC	1990	DMX06223	18,79		
540 EXC	1991	DMX06221	21,33	DMX06247	17,48
540 MX	1990	DMX06223	18,79		
540 MX	1991	DMX06221	21,33	DMX06247	17,48
540 SXC	1999			DMX06247	17,48
550 DXC	1992	DMX06221	21,33	DMX06247	17,48
550 EXC	1992	DMX06221	21,33	DMX06247	17,48
550 MX	1992	DMX06221	21,33	DMX06247	17,48
550 MX	93-96	DMX06221	21,33	DMX06247	17,48
550 MXC	93-96	DMX06221	21,33	DMX06247	17,48
600 DXC	1990	DMX06220	20,40		
600 EGS	1990	DMX06220	20,40		
600 EXC	1990	DMX06220	20,40		
600 LC4	1991	DMX06221	21,33		

RUEDAS Y NEUMÁTICOS

MOTOR

ADMISIÓN / ESCAPE
REFRIGERACIÓN

ELÉCTRICO

SUSPENSIÓN / DIRECCIÓN

FRENOS

TRANSMISIÓN

CONTROLES Y MANDOS

CHASIS

ACCESORIOS



Cojinetes ruedas delanteras y traseras



600 MX	1990	DMX06220	20,40		
620 EGS	1997	DMX06221	21,33		
620 SC	96-97			DMX06247	17,48
620 SX	96-99	DMX06221	21,33	DMX06247	17,48
625 EXC	03-05	DMX06222	17,55	DMX06247	17,48
625 MXC	03-05	DMX06222	17,55	DMX06247	17,48
625 SX	03-05	DMX06222	17,55	DMX06247	17,48
640 Adventure	98-00	DMX06221	21,33		
640 Adventure	2003	DMX06222	17,55		
640 LC4-E	00-01	DMX06222	17,55		
690 Duke	2008	DMX06223	18,79		
690 Rally Replica	2008	DMX06223	18,79		
690 R Enduro	09-12	DMX06223	18,79	DMX06247	17,48
950 Adventure	04-06	DMX06223	18,79		
950 Super Duke	06-08	DMX06223	18,79		
950 Super Enduro	2007	DMX06223	18,79	DMX06247	17,48
990 Adventure	07-12	DMX06223	18,79	DMX06247	17,48
990 Super Moto	10-11	DMX06223	18,79	DMX06247	17,48

SUZUKI

	Año	Delanteros	P.V.P.	Traseros	P.V.P.
RM 60	2003			DMX06213	25,36
RM 65	03-05	DMX06213	25,36	DMX06213	25,36
RM 80	86-89			DMX06205	17,48
RM 80	90-01	DMX06203	23,37	DMX06224	15,19
RM 85	02-12	DMX06203	23,37	DMX06224	15,19
DR 100	83-90	DMX06203	23,37		
RM 100	2003			DMX06214	17,05
DR-Z 110	03-05	DMX06239	18,17	DMX06240	26,72
DR 125	82-96	DMX06203	23,37		
DR-Z 125	03-05			DMX06213	25,36
DR-Z 125 L	03-06	DMX06203	23,37	DMX06213	25,36
RM 125	87-94	DMX06220	20,40		
RM 125	1995	DMX06220	20,40	DMX06225	20,73
RM 125	96-99	DMX06218	18,79	DMX06225	20,73
RM 125	2000	DMX06218	18,79	DMX06226	25,11
RM 125	01-08	DMX06227	18,79	DMX06226	25,11
SP 125	82-88	DMX06203	23,37		
DR 200	86-08	DMX06203	23,37		
SP 200	86-88	DMX06203	23,37		
DR 250	82-85	DMX06203	23,37	DMX06228	30,32
DR 250	90-93			DMX06228	30,32
DR-Z 250	01-07	DMX06229	21,02	DMX06228	30,32
RM 250	87-95	DMX06220	20,40		
RM 250	96-99	DMX06218	18,79	DMX06225	18,41
RM 250	2000	DMX06218	18,79	DMX06226	25,11
RM 250	01-08	DMX06227	18,79	DMX06226	25,11
RMX 250	93-98	DMX06200	22,26		
RM-Z 250	04-06	DMX06218	18,79	DMX06238	20,40
RM-Z 250	07-13	DMX06251	20,40	DMX06208	20,52
DR 350	90-99	DMX06200	22,26	DMX06228	30,32
DR-Z 400 E	00-07	DMX06218	18,79		
DR-Z 400 S	00-13	DMX06218	18,79		
DR-Z 400 SM	05-08	DMX06218	18,79		
RM-Z 450	05-11	DMX06251	20,40	DMX06208	20,52
RMX 450	2010	DMX06251	20,40	DMX06208	20,52
DR 650 SE	96-05	DMX06200	22,26	DMX06208	20,52

YAMAHA	Año	Delanteros	P.V.P.	Traseros	P.V.P.
DT 50	88-90			DMX06231	17,30
TTR 50	06-14	DMX06230	19,03	DMX06230	19,03
YZ 80	93-01	DMX06230	19,03	DMX06224	15,19
YZ 85	02-14	DMX06230	19,03	DMX06224	15,19
TT 125	2000	DMX06231	17,30		
TTR 125 L Disco	00-14	DMX06232	19,78	DMX06231	17,30
TTR 125 Mordaza	00-09	DMX06231	17,30	DMX06231	17,30
YZ 125	86-97			DMX06233	23,13
YZ 125	1998	DMX06234	19,16	DMX06233	23,13
YZ 125	99-14	DMX06234	19,16	DMX06235	21,20
RT 180	95-98	DMX06214	17,05		
IT 200	1986	DMX06214	17,05		
WR 200	1992			DMX06233	23,13
TT 225	86-87	DMX06214	17,05		
TT 225	99-00	DMX06214	17,05		
TTR 225 R	01-05	DMX06214	17,05		
XT 225	92-07	DMX06214	17,05		
TTR 230	05-07	DMX06214	17,05		
WR 250	1991	DMX06214	17,05	DMX06233	23,13
WR 250	92-97			DMX06233	23,13
WR 250 F	01-14	DMX06234	19,16	DMX06235	21,20
YZ 250	83-87	DMX06214	17,05		
YZ 250	88-91	DMX06214	17,05	DMX06233	23,13
YZ 250	92-97			DMX06233	23,13
YZ 250	1998	DMX06234	19,16	DMX06233	23,13
YZ 250	99-14	DMX06234	19,16	DMX06235	21,20
YZ 250 F	01-08	DMX06234	19,16	DMX06235	21,20
YZ 250 F	09-14	DMX06234	19,16	DMX06252	20,40
TT 350	86-87	DMX06214	17,05		
XT 350	85-00	DMX06214	17,05		
WR 400 F	1998	DMX06234	19,16	DMX06233	23,13
WR 400 F	99-00	DMX06234	19,16	DMX06235	21,20
YZ 400 F	1998	DMX06234	19,16	DMX06235	21,20
YZ 400 F	1999	DMX06234	19,16	DMX06233	23,13
WR 426 F	2000			DMX06235	21,20
WR 426 F	02-01	DMX06234	19,16	DMX06235	21,20
YZ 426 F	00-02	DMX06234	19,16	DMX06235	21,20
WR 450 F	03-14	DMX06234	19,16	DMX06235	21,20
YZ 450 F	03-08	DMX06234	19,16	DMX06235	21,20
YZ 450 F	09-13	DMX06234	19,16	DMX06252	20,40
YZ 490	84-90	DMX06214	17,05		
WR 500	92-93	DMX06214	17,05	DMX06233	23,13
TT 600	85-86	DMX06214	17,05		
XT 600	84-95	DMX06214	17,05		

MOTOR

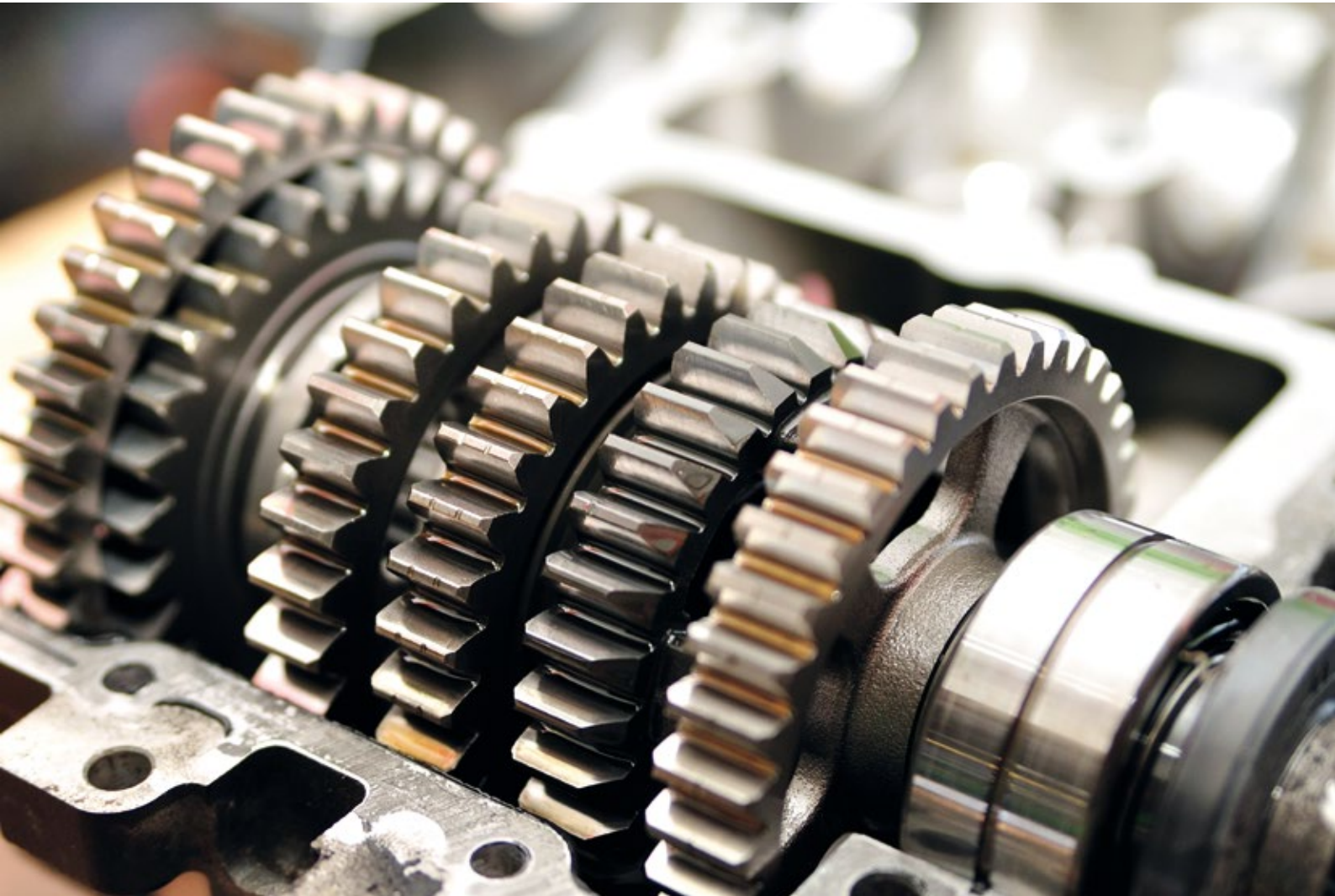



Kit de pistón racing Incluye Pistón, Segmentos, Bulón, Circlips



Modelo X-PROJECT
Más ligero, faldas de pistón recubiertas para limitar la fricción, reduce el balanceo del pistón y ranuras anti-detonación, ranura acumuladora, lubricadores de doble salida, forjado, cúpulas sostenidas.



Modelo CP
Ranuras anti-detonación, ranura acumuladora, lubricadores de doble salida, forjado, cúpulas sostenidas.

HONDA		Cilindro	Kit Pistón	P.V.P.	Juntas Cilindro COMETIC	P.V.P.
• CRF 150R 04-09	Diámetro: 66 mm Carrera: 43.7 mm					
66 mm. Calibre STD. (149 cc)	13.0:1	Original (Válvula cóncava)	M2043C	185,40		
• CRF 250R 04-08 SOLO COMPETICIÓN	Diámetro: 78 mm Carrera: 52.2 mm					
78 mm. Calibre STD. (249 cc)	14.5:1	Original	MX2108C	185,40	MC7185	44,52
• CRF 250R 2009	Diámetro: 78 mm Carrera: 52.2 mm					
78 mm. Calibre STD. (249 cc)	13.5:1	Original	M2060C	185,40	MC7185	44,52
• CRF 250R 10-13	Diámetro: 76,8 mm Carrera: 53,8 mm					
76,8 mm. Calibre STD. (249 cc)	13.5:1	Original	MX2070C	185,40	MC3288	44,52
• XR 400 R 96-09	Diámetro: 85 mm Carrera: 70 mm					
86 mm Sobremedida (407 cc)	12.5:1	Rectificar	M2006	185,40		
• CRF 450R 02-08	Diámetro: 96 mm Carrera: 62 mm					
96 mm. Calibre STD. (449 cc)	13.5:1	Original	M2010	185,40		
• CRF 450R 09-13	Diámetro: 96 mm Carrera: 62 mm					
96 mm. Calibre STD. (449 cc)	13.0:1	Original	MX2058	185,40	MC3270	58,31
96 mm. Calibre STD. (449 cc)	13.5:1	Original	MX2059	185,40	MC3270	58,31
• CRF 450R 09-13 SOLO COMPETICIÓN	Diámetro: 96 mm Carrera: 62 mm					
96 mm. Calibre STD. (449 cc)	14.0:1	Original	M2063	185,40	MC3270	58,31
KAWASAKI		Cilindro	Kit Pistón	P.V.P.	Juntas Cilindro COMETIC	P.V.P.
• KX 250F 05-09	Diámetro: 77 mm Carrera: 53.6 mm					
77 mm. Calibre STD. (250 cc)	13.5:1	Original	M3023C	185,40	MC3054 (05-08) MC3267HB (09)	58,48 52,79
79 mm Sobremedida (263 cc)	12.5:1	Rectificar y nicasilar	M3001C	185,40		
• KX 250F 2010	Diámetro: 77 mm Carrera: 53.6 mm					
77 mm. Calibre STD. (250 cc)	14.2:1	Original	MX3051C	185,40	MC3267HB	52,79
• KX 450F 04-08	Diámetro: 96 mm Carrera: 62.1 mm					
96 mm. Calibre STD. (449 cc)	13.5:1	Original	M3010	185,40		
• KX 450F 09-10	Diámetro: 96 mm Carrera: 62.1 mm					
96 mm. Calibre STD. (449 cc)	13.5:1	Original	M3036	185,40		
KTM		Cilindro	Kit Pistón	P.V.P.	Juntas Cilindro COMETIC	P.V.P.
• 450 SX-F / XC-F / RSF 07-10	Diámetro: 97 mm Carrera: 60.8 mm					
97 mm. Calibre STD. (450 cc)	13.5:1	Original	M9007	185,40		-
• 450 EXC 03-07 / 450 XC 08-12	Diámetro: 89 mm Carrera: 72 mm					
89 mm. Calibre STD. (450 cc)	13.0:1	Original	M9009	185,40		-
• 450 EXC 03-12 / 450 XC 2008 SOLO COMPETICIÓN	Diámetro: 89 mm Carrera: 72 mm					
89 mm. Calibre STD. (450 cc)	13.5:1	Original	M9010	185,40		-
• 520 EXC 00-02 / 525 EXC 03-07	Diámetro: 95 mm Carrera: 72 mm					
95 mm. Calibre STD. (525 cc)	13.0:1	Original	M9012	185,40		-
SUZUKI		Cilindro	Kit Pistón	P.V.P.	Juntas Cilindro COMETIC	P.V.P.
• RM-Z 250 04-06	Diámetro: 77 mm Carrera: 53.6 mm					
77 mm. Calibre STD. (250 cc)	13.5:1	Original	M3023C	185,40	MC3054	58,48
79 mm Sobremedida (263 cc)	12.5:1	Rectificar y nicasilar	M3001C	185,40		
• RM-Z 250 07-09	Diámetro: 77 mm Carrera: 53.6 mm					
77 mm. Calibre STD. (249 cc)	13.5:1	Original	M3017C	185,40		
77 mm. Calibre STD. (249 cc)	14.2:1	Original	M3016C	185,40		
• RM-Z 450 08-09	Diámetro: 96 mm Carrera: 62.1 mm					
96 mm. Calibre STD. (449 cc)	13.0:1	Original	MX3020	185,40		
96 mm. Calibre STD. (449 cc)	13.5:1	Original	M3021	185,40		
96 mm. Calibre STD. (449 cc)	13.5:1	Original	MX3021	185,40		
YAMAHA		Cilindro	Kit Pistón	P.V.P.	Juntas Cilindro COMETIC	P.V.P.
• YZ 250F 05-13	Diámetro: 77 mm Carrera: 53.6 mm					
77 mm. Calibre STD. (250 cc)	13.5:1	Original	M1034C	185,40	MC3057	58,36
77 mm. Calibre STD. (250 cc)	13.5:1	Original	MX1034C	185,40	MC3057	58,36
77 mm. Calibre STD. (250 cc)	14.0:1	Original	M1035C	185,40	MC3057	58,36
79 mm. Sobremedida. (263 cc)	13.5:1	Rectificar y nicasilar	M1036C	185,40	MC3057	58,36
• WR 250 09-10	Diámetro: 77 mm Carrera: 53.6 mm					
81 mm. Sobremedida. (276 cc)	12.5:1	Cilindro especial o camisa	MX1067C	185,40		
• YZ 450F 03-09	Diámetro: 95 mm Carrera: 63.4 mm					
95 mm. Calibre STD. (449 cc)	13.5:1	Original	M1011	185,40	MC7947-EST (03-05) MC7908-EST (06-09)	67,95 67,95
• YZ 450F 03-09 SOLO COMPETICIÓN	Diámetro: 95 mm Carrera: 63.4 mm					
95 mm. Calibre STD. (449 cc)	13.75:1	Original	M1043	185,40	MC7947-EST (03-05) MC7908-EST (06-09)	67,95 67,95
• YZ 450F 10-13	Diámetro: 97 mm Carrera: 60.8 mm					
97 mm. Calibre STD. (449 cc)	13.0:1	Original	MX1068	185,40	MC3395	58,15



Kit de pistón y juntas

		PISTÓN, SEGMENTOS, BULÓN, CIRCLIPS		RODAMIENTO PISTÓN		SEGMENTOS		JUNTAS CILINDRO		JUNTAS MOTOR		
BETA	Año	Medidas (mm)	Referencia	P.V.P.	Referencia	P.V.P.	Referencia	P.V.P.	Referencia	P.V.P.	Referencia	P.V.P.
RK6 Enduro	97-02	39,46 39,47 39,48	NX70000 NX70000-B NX70000-C	60,18	N09B041	4,06	NX70000R	5,83				
RR 250 Enduro 2t	13-14	66,34 66,35 66,36	NX70051 NX70051-B NX70051-C	93,66	N09B0371	8,65	NX70050R	7,96				
		PISTÓN, SEGMENTOS, BULÓN, CIRCLIPS		RODAMIENTO PISTÓN		SEGMENTOS		JUNTAS CILINDRO		JUNTAS MOTOR		
GAS GAS	Año	Medidas (mm)	Referencia	P.V.P.	Referencia	P.V.P.	Referencia	P.V.P.	Referencia	P.V.P.	Referencia	P.V.P.
MC 125	02-10	53,94 53,95 53,96 54,44 54,94 55,44	NX10000 NX10000-B NX10000-C NX10000-2 NX10000-4 NX10000-6	76,70	N09B0381	8,65	NX10000R NX10000R NX10000R NX10000-2R NX10000-4R NX10000-6R	10,98	NX12000T	33,15		
EC 125	02-10	53,94 53,95 53,96	NX10003 NX10003-B NX10003-C	68,49	N09B0381	8,65	NX20000R	9,53	NX12000T	33,15		
MC 125 (plano)	02-10	53,94 53,95 53,96 54,44 54,94 55,44	NX10000 NX10000-B NX10000-C NX10000-2 NX10000-4 NX10000-6	76,70	N09B0381	8,65	NX10000R NX10000R NX10000R NX10000-2R NX10000-4R NX10000-6R	10,98	NX12000T	33,15		
EC 250	97-14		NX70051 NX70051-B NX70051-C	93,66			NX70050R	7,96	NX12001T	38,13		
EC 250 F 4t	10-15	76,94 76,95 76,96	NX40033 NX40033-B NX40033-C	174,78			NX20030R	15,58	NX40032T	43,29	NX40036F	66,14
EC 450 F	13-15	94,96 94,97 94,98	NX40045 NX40045-B NX40045-C	179,75			NA40009R	25,39	NX40046T	44,37		
		PISTÓN, SEGMENTOS, BULÓN, CIRCLIPS		RODAMIENTO PISTÓN		SEGMENTOS		JUNTAS CILINDRO		JUNTAS MOTOR		
HONDA	Año	Medidas (mm)	Referencia	P.V.P.	Referencia	P.V.P.	Referencia	P.V.P.	Referencia	P.V.P.	Referencia	P.V.P.
CRF 70 F XR 70 R	04-12 97-03								NX10070T	15,83	NX10070F	31,72
CR 80 R** Cilindro Nikasil	86-02	46,94 46,95 46,96 47,44 47,94 48,44	NX10080 NX10080-B NX10080-C NX10080-2 NX10080-4 NX10080-6	74,32	N09B0121	7,29	NX10080R NX10080R NX10080R NX10080-2R NX10080-4R NX10080-6R	7,35	NX10080T (86-91) NX10081T (92-02)	13,65 22,16	NX10080F (86-91) NX10081F (92-02)	35,25 42,27
CRF 80 F XR 80	04-12 93-03								NX10083T	28,46	NX10083F	47,82
CR 85 R Compr. 8.4:1 Cilindro Nikasil	03-07	47,44 47,45 47,46 47,94 48,44	NX10080-2 NX10080-2B NX10080-2C NX10080-4 NX10080-6	74,32	N09B0121	7,29	NX10080-2R NX10080-2R NX10080-2R NX10080-4R NX10080-6R	6,65	NX10081T	22,16	NX10081F	42,27
CRF 100 F XR 100 R	04-13 92,03								NX10100T	22,82	NX10100F	50,48
CR 125 R Compr. 8.6:1 Cilindro Nikasil	92-03	53,94 53,95 53,96 54,44 54,94 55,44	NX10000 NX10000-B NX10000-C NX10000-2 NX10000-4 NX10000-6	76,70	N09B0011	7,29	NX10000R NX10000R NX10000R NX10000-2R NX10000-4R NX10000-6R	10,98	NX10000T (92-99) NX10001T (00-02) NX10002T (03)	24,01 24,76 35,40	NX10000F (92-99) NX10001F (00-02) NX10002F (03)	51,64 51,64 58,65
CR 125 R Compr. 8.6:1 Cilindro Nikasil	04-07	53,94 53,95 53,96	NX10003 NX10003-B NX10003-C	68,49	N09B0011	7,29	NX20000R	9,53	NX10003T (04) NX10004T (05-07)	36,86 37,91	NX10003F (04) NX10004F (05-07)	57,55 65,42
CRE F125 X CRM F 125 X	08-10 08-10								NX40093T	35,61	NX40093F	87,44
CRF 150 F	03-05								NX10150T	35,53	NX10150F	58,71
CRF 150 F	06-15								NX10151T	29,81	NX10151F	52,11
CRF 150 R	07-14								NX10152T	66,53	NX10152F	101,40
XR 200 R	93-02								NX10200T	24,31	NX10200F	37,05

** Pistón o aros Namura no son intercambiables por aros o pistones originales. / En Azul pistones Hyperdryve.

RUEDAS Y NEUMÁTICOS
 MOTOR
 ADMISIÓN / ESCAPE REFRIGERACIÓN
 ELÉCTRICO
 SUSPENSIÓN / DIRECCIÓN
 FRENS
 TRANSMISIÓN
 CONTROLES Y MANDOS
 CHASIS
 ACCESORIOS

Kit de pistón y juntas



Kit juntas motor

		PISTÓN, SEGMENTOS, BULÓN, CIRCLIPS		RODAMIENTO PISTÓN		SEGMENTOS		JUNTAS CILINDRO		JUNTAS MOTOR		
CRF 230 F	03-15									NX10230F	54,01	
CRF 230 L	08-09							NX10230T	32,49	(CRF230F)		
CRF 230 M	08-09									NX10231F	33,24	
										(CRF230L,M)		
CR 250 R	86-96	66,34 66,35 66,36 66,84 67,34 67,84	NX10026 NX10026-B NX10026-C NX10026-2 NX10026-4 NX10026-6	90,57	N095051	9,17	NX10026R NX10026R NX10026R NX10026-2R NX10026-4R NX10026-6R	15,58	NX10026T (86-91) NX10025T (92-01)	17,90 26,03	NX10026F (89-91) NX10025F (92-01)	51,64 54,01
CR 250 R	97-01	66,34 66,35 66,36 66,84 67,34 67,84	NX10025 NX10025-B NX10025-C NX10025-2 NX10025-4 NX10025-6	91,78	N095051	9,17	NX10025R NX10025R NX10025R NX10025-2R NX10025-4R NX10025-6R	14,56	NX10025T	26,03	NX10025F	54,01
CR 250 R	02-04	66,34 66,35 66,36	NX10027 NX10027-B NX10027-C	91,53	N095051	9,17	NX10025R	14,56	NX10027T	33,51	NX10027F	58,77
CR 250 R	05-07	66,34 66,35 66,36	NX10028 NX10028-B NX10028-C	80,37	N095051	9,17	NX10028R	11,88	NX10028T	34,37	NX10028F	65,70
CRF 250 R**	04-09	77,96	NX10035	157,73			NX10035R	19,20	NX10030T (04-13)	59,73	NX10030F (04-13)	106,48
CRF 250 X**	04-16	77,97	NX10035-B									
Compr. 13.2:1		77,98	NX10035-C									
CRF 250 R	10-13	76,80 76,81 76,82	NX10039 NX10039-B NX10039-C	157,51			NX10039R	19,01	NX10031T	67,28	NX10031F	102,12
CRF 250 R	14-16	76,80 76,81 76,82	NX10041 NX10041-B NX10041-C	166,88			NX10039R	19,01	NX10031T	67,28	NX10031F	102,12
Compr. 13.5:1												
CRF 250 L	13-16								NX10040T	84,79	NX10040F	119,05
XR 400 R	96-04	84,97 85,47 85,97 86,47	NA10003 NA10003-2 NA10003-4 NA10003-6	102,64			NA10003R NA10003-2R NA10003-4R NA10003-6R	22,93	NA10003T	47,35	NX10006F	73,08
CRF 450 R	02-08	95,97 95,98 95,99	NX10045 NX10045-B NX10045-C	174,25			NX10045R	21,69	NX10045T (02-06) NX10046T (07-08)	57,74 59,18	NX10045F (02-06) NX10047F (07-08)	96,29 114,71
Compr. 12.0:1												
CRF 450 R**	09-12	95,97 95,98 95,99	NX10046 NX10046-B NX10046-C	171,96			NX10045R	21,69	NX10048T	72,17	NX10048F	109,38
Compr. 12.0:1												
CRF 450 X	05-16	95,97 95,98 95,99	NX10045 NX10045-B NX10045-C	174,25			NX10045R	21,69	NX10046T	59,18	NX10046F	104,85
Compr. 12.0:1												
CR 500	84-01								NX10050T (89-01)	31,39	NX10050F (89-01)	60,12

		PISTÓN, SEGMENTOS, BULÓN, CIRCLIPS		RODAMIENTO PISTÓN		SEGMENTOS		JUNTAS CILINDRO		JUNTAS MOTOR		
HUSABERG	Año	Medidas (mm)	Referencia	P.V.P.	Referencia	P.V.P.	Referencia	P.V.P.	Referencia	P.V.P.	Referencia	P.V.P.
TE 125	12-14	53,94 53,95 53,96	NX70029 NX70029-B NX70029-C	82,83	N09B0131	8,65	NX70029R	17,84	NX70030T	33,29	NX70030F	68,16
TE 250 (motor KTM 2t)	11-14	66,34 66,35 66,36	NX70051 NX70051-B NX70051-C	93,66	N09B0371	8,65	NX70050R	7,96	NX70053T	23,43		
FE 250	2013	75,96 75,97 75,98	NX70060 NX70060-B NX70060-C	170,47			NX70060R	19,01	NX70060T	67,11		
TE 300	11-12		NX70034 NX70034-B NX70034-C	121,31	N09B0371	8,65	NX70034R	22,65	NX70036T	23,90	NX70036F	57,41
FC 350	2014	87,96	NX70062	190,83			NX70062R	19,75	NX70073T	104,63		
FE 350	13-14	87,97	NX70062-B									
		87,98	NX70062-C									
FE 390	10-11								NX70068T	66,67		
FE 450	09-12	94,94	NX70068	179,03			NX70041R	19,98	NX70068T FX450E (10-11)	66,67		
FX 450	10-12	94,95	NX70068-B									
		94,96	NX70068-C									
FE 570	2010								NX70068T	66,67		
FS 570	2010											

** Pistón o aros Namura no son intercambiables por aros o pistones originales. / En Azul pistones Hyperdryve.



Kit de pistón y juntas



Kit juntas cilindro

HUSQVARNA	Año	Medidas (mm)	PISTÓN, SEGMENTOS, BULÓN, CIRCLIPS		RODAMIENTO PISTÓN		SEGMENTOS		JUNTAS CILINDRO		JUNTAS MOTOR	
			Referencia	P.V.P.	Referencia	P.V.P.	Referencia	P.V.P.	Referencia	P.V.P.	Referencia	P.V.P.
TC 85	2014	46,95 46,96 46,97	NX70004 NX70004-B NX70004-C	58,49	N09B0121	7,29	NX10080R	7,35	NX70007T	22,21	NX70007F	49,29
CR 125 WR 125 WRE 125 SM 125 / S	97-14 97-14 98-10 98-14	53,94 53,95 53,96	NX10003 NX10003-B NX10003-C	68,49	N09B0011	7,29	NX20000R	9,53	NX90000T	30,83		
TE 125 SM S4	10-11								NX40093	35,61	NX40093F	87,44
TC 125 TE 125	2014 2014	53,94 53,95 53,96	NX70029 NX70029-B NX70029-C	82,83	N09B0131	8,65	NX70029R	17,84	NX70030T	33,29	NX70030F	68,16
CR 250 R	98-13	66,34 66,35 66,36	NX10025 NX10025-B NX10025-C	91,78			NX10025R	14,56				
TC 250 TE 250 TXC 250 SMR 250	03-04 03-04 03-04 03-04								NX90004T	46,00		
TC 250 (motor KTM) TE 250 (motor KTM)	14-16 14-16	66,34 66,35 66,36	NX70051 NX70051-B NX70051-C	93,66	N09B0131	8,65	NX70050R	7,96	NX70053T	23,43	NX70053F	53,32
TC 250 TE 250 TXC 250 SMR 250	05-11 05-12 05-12 05-09								NX90005T (05-09) NX90011T (10-11)	99,33 88,87	NX90011F (10-11)	178,15
TC 250 TE 250 TXC 250	12-14 13-14 13-14								NX90010T	85,87	NX90010F	173,45
FC 250	2014								NX70065T	103,64	NX70065F	200,17
CR 250 WR 250 WR 300	99-12 99-14 09-14								NX90003T	36,99		
TE 300 (motor KTM) WR 300 (motor KTM)	14-16 08-13	71,94 71,95 71,96	NX70034 NX70034-B NX70034-C	121,31	N09B0131	8,65	NX70034R	22,65	NX70036T TE300	23,90	NX70036F TE300	57,41
FE 350 FC 350	14-15 14-15	87,96 87,97 87,98	NX70062 NX70062-B NX70062-C	190,83			NX70062R	19,75	NX70073T FC350	104,63	NX70073F FC350	187,51
TC 450 TE 450 SMR 450 TC 510 TE 510 R	03-04 03-04 03-04 2004 2004								NX90008T	50,81		
TE 450 TXC 450 SMR 450 TC 510 SMR 510	05-09 05-10 05-09 05-10 05-09								NX90009T	99,33		
TC 610 TE 610 SM 610 S WXE 610	93-06 90-06 2001 90-96								NX90012T	50,42		

KAWASAKI	Año	Medidas (mm)	PISTÓN, SEGMENTOS, BULÓN, CIRCLIPS		RODAMIENTO PISTÓN		SEGMENTOS		JUNTAS CILINDRO		JUNTAS MOTOR	
			Referencia	P.V.P.	Referencia	P.V.P.	Referencia	P.V.P.	Referencia	P.V.P.	Referencia	P.V.P.
KDX 50	03-06	40,96 41,46 41,96	NX30050 NX30050-2 NX30050-4	41,03	N09B0001	7,29	NX30050R NX30050-2R NX30050-4R	9,53	NX20055T	8,68	NX20055F	23,15
KX 60 Cilindro Nikasil	85-03	42,95 42,96 42,97	NX20060 NX20060-B NX20060-C	59,04	N09B0001	7,29	NX20060R	10,03	NX20060T	11,41	NX20060F	23,98
KX 65 Compr. 8.4:1 Cilindro Nikasil	00-14	44,45 44,46 44,47 44,96 45,46 45,95	NX20065 NX20065-B NX20065-C NX20065-2 NX20065-4 NX20065-6	59,04	N09B0431	7,82	NX20060-6R NX20060-6R NX20060-6R NX20065-2R NX20065-4R NX20065-6R	10,03	NX20065T	20,31	NX20065F (00-05) NX20066F (06-14)	39,04 37,38
KX 80 Cilindro Nikasil	88-00	47,95 47,96 47,97 48,45 48,95	NX20080 NX20080-B NX20080-C NX20080-2 NX20080-4	81,80	N09B0061	8,12	NX20080R NX20080R NX20080R NX20080-2R NX20080-4R	14,20	NX20082T (88-90) NX20080T (91-97) NX20081T (98-00)	12,43 20,45 24,67	NX20082F (88-90) NX20080F (91-97) NX20081F (98-00)	28,68 29,15 36,55



Kit de pistón y juntas

			PISTÓN, SEGMENTOS, BULÓN, CIRCLIPS	RODAMIENTO PISTÓN		SEGMENTOS		JUNTAS CILINDRO		JUNTAS MOTOR		
KX 85 Compr. 9.2:1 Cilindro Nikasil	01-13	48,45 48,46 48,47	NX20085 NX20085-B NX20085-C	83,01	N09B0061	8,12	NX20080-2R	14,20	NX20085T	20,24	NX20085F	48,76
KX 100	95-13	52,44 52,45 52,46	NX20010 NX20010-B NX20010-C	80,45	N09B0061	8,12	NX20010R	13,54	NX20010T	31,11	NX20010F	62,63
KLX 110	02-13								NX20011T	28,46	NX20011F	48,71
KLX 125 L	03-06								NX20007T	27,32	NX20007F	52,11
KX 125	90-91	53,95							NX20001T	27,46	NX20001F	50,01
KX 125	92-94	53,95							NX20003T	29,70	NX20003F	53,60
KX 125	95-97	53,95			N09B0131	8,65			NX20002T	30,83	NX20002F	51,64
KX 125	98-00	53,94 53,95 53,96	NX20000 NX20000-B NX20000-C	75,01	N09B0131	8,65	NX20000R	9,53	NX20000T	32,88	NX20000F	51,64
KX 125	01-02	53,94 53,95 53,96	NX20001 NX20001-B NX20001-C	77,94	N09B0131	8,65	NX20000R	9,53	NX20000T	32,88		
KX 125	2003	53,95 53,96 53,97	NX20002 NX20002-B NX20002-C	79,43	N09B0131	8,65	NX20000R	9,53	NX20005T	25,61	NX20004F	47,96
KX 125	04-05	53,95 53,96 53,97	NX20005 NX20005-B NX20005-C	69,24	N09B0131	8,65	NX20000R	9,53	NX20005T	25,61	NX20004F	47,96
KDX 200	89-94								NX20008T	37,91	NX20008F	56,11
KDX 220	97-05								NX20009T	39,12	NX20009F	61,56
KDX 250	91-94								NX20023T	43,29	NX20023F	69,57
KLX 250 R S 250 SF	KLX 250 KLX 94-96 06-14 09-10								NX20036T	34,65	NX20036F	69,24
KX 250** Cilindro Nikasil	92-04	66,35 66,36 66,37 66,85 67,35 67,85	NX20025 NX20025-B NX20025-C NX20025-2 NX20025-4 NX20025-6	89,63	N09B0221	9,17	NX20025R NX20025R NX20025R NX20025-2R NX20025-4R NX20025-6R	15,78	NX20026T (92-03) NX20028T (04)	31,99 44,43	NX20026F (93-03) NX20028F (04)	66,47 62,33
KX 250 Cilindro Nikasil	05-08	66,35 66,36 66,37	NX20029 NX20029-B NX20029-C	92,42	N09B0221	9,17	NX20029R	15,58	NX20029T	31,11	NX20029F	53,60
KX 250 F Compr. 12.6:1 Forjado Cilindro Chrome composite	04-05	76,95 76,96 76,97	NX20030 NX20030-B NX20030-C	171,90			NX20030R	15,58	NX20030T	71,42	NX20030F	83,99
KX 250 F Compr. 13.5:1 Forjado	06-09	76,95 76,96 76,97	NX20031 NX20031-B NX20031-C	171,90			NX20030R	15,58	NX20030T (06-08) NX20017T (2014)	71,42 68,99	NX20030F (06-08) NX20017F (2014)	83,99 103,19
KX 250 F** Compr. 13.8:1 Forjado Cilindro Nikasil	10-16	76,95 76,96 76,97	NX20017 NX20017-B NX20017-C	177,14			NX20017R	19,20	NX20017T (10-14)	68,99	NX20017F (10-13)	103,19
KLX 300 R	97-07								NX20037T	34,37	NX20037F	68,08
KLX 400 Compr. 11.3:1 Cilindro Nikasil	03-06	89,96 89,97 89,98 90,46 90,96 91,46	NA30002 NA30002-B NA30002-C NA30002-2 NA30002-4 NA30002-6	135,63			NA30002R NA30002R NA30002R NA30002-2R NA30002-4R NA30002-6R	25,58	NA30002T	40,45	NX30041F	101,54
KLX 450 R	08-14								NX20045T	71,42	NX20048F	104,30
KX 450 F	06-16	95,95 95,96 95,97	NX20045 NX20045-B NX20045-C	173,48			NX20045R	21,69	NX20045T (06-08) NX20018T (09-14)	71,42 72,83	NX20045F (06-08) NX20018F (09-14)	112,31 121,48
KX 500	89-04				N09B036	6,47			NX20050T	33,49	NX20050F	45,03

** Pistón o aros Namura no son intercambiables por aros o pistones originales. / En Azul pistones Hyperdryve.



Kit de pistón y juntas



KTM	Año	Medidas (mm)	PISTÓN, SEGMENTOS, BULÓN, CIRCLIPS		RODAMIENTO PISTÓN		SEGMENTOS		JUNTAS CILINDRO		JUNTAS MOTOR	
			Referencia	P.V.P.	Referencia	P.V.P.	Referencia	P.V.P.	Referencia	P.V.P.	Referencia	P.V.P.
50 SX pro JR / SR LC 50 Mini / Jr / Sen. Adven. 50 SX Pro JR, SR LC, sen. Adv. 50 SX pro, SR LC, sen. Adv. 50 SX, SX JR, sen. Adv. 50 SX, SX JR, SX mini LC cilindro nikasil	01-02 2002 2003 04-05 06-07 2008	39,46 39,47 39,48	NX70000 NX70000-B NX70000-C	60,18	N09B041	4,06	NX70000R	5,83	NX70000T SX 50 LC (01-08) NX70001T ADV 50 A/C(02-08) NX70010T ADV 50 A/C(97-01)	11,88 9,31 9,78	NX70000F SX 50 LC (01-08) NX70001F ADV 50 A/C (02-08)	20,86 16,60
50 SX	09-16	39,46 39,47 39,48	NX70020 NX70020-B NX70020-C	62,14			NX70000R	5,83	NX70020T	15,47	NX70020F	47,30
60 SX cilindro nikasil	98-00	43,46 43,47 43,48	NX70002 NX70002-B NX70002-C	56,61			NX70002R	5,83				
65 SX 65 XC cilindro nikasil	98-08 2008	44,96 44,97 44,98	NX70002-6 NX70002-6B NX70002-6C	56,61	N09B0422	7,29	NX70002-6R	5,83	NX70003T	16,58	NX70003F	43,96
65 SX 65 XC	09-15 09-15	44,96 44,97 44,98	NX70005 NX70005-B NX70005-C	62,61	N09B0422	7,29	NX70002-6R	5,83	NX70005T	16,74	NX70005F	55,17
85 SX 85 XC cilindro nikasil	03-14 03-14	46,94 46,95 46,96	NX70004 NX70004-B NX70004-C	58,49	N09B0121	7,29	NX10080R	7,35	NX70004T (03-12) NX70007T (13-14)	25,75 22,21	NX70004F (03-12) NX70007F (13-14)	53,49 49,29
125 EXC 125 SX cilindro nikasil	94-00 94-00	54,19 54,20 54,21	NX70026 NX70026-B NX70026-C	81,48	N09B0131	8,65	NX20000-1R	9,53	NX70025T (91-97) NX70026T (98-00)	25,00 28,02	NX70025F (91-97)	59,87
125 SX** 125 EXC** cilindro nikasil 2 segmentos	01-14 01-14	53,94 53,95 53,96	NX70029 NX70029-B NX70029-C	82,83	N09B0131	8,65	NX70029R	17,84	NX70026T (2001) NX70027T (02-06) NX70030T (07-14)	28,02 28,90 33,29	NX70026F (2001) NX70027F (02-06) NX70030F (07-14)	60,09 55,59 68,16
125 SX GP SERIES** cilindro nikasil 1 segmento	01-14	53,95 53,96 53,97	NX30002 NX30002-B NX30002-C	68,96	N09B0131	8,65	NX20000R	9,53	NX70026T (2001) NX70027T (02-06) NX70030T (07-13)	28,02 28,90 33,29	NX70027F (02-06) NX70030F (07-13)	55,59 68,16
200 EXC 200 MXC	98-14 98-14	63,94 63,95 63,96	NX70021 NX70021-B NX70021-C	101,48	N09B0821	8,65	NX70021R	22,43	NX70022T EXC (98-02) NX70021T EXC (03-14)	31,66 23,54	NX70022F EXC (98-02) NX70021F EXC (03-14)	67,72 48,76
200 SX	98-14	63,94 63,95 63,96	NX70022 NX70022-B NX70022-C	88,36	N095131	8,65	NX70022R	11,60	NX70022T EXC (98-02) NX70021T EXC (03-14)	31,66 23,54	NX70022F EXC (98-02) NX70021F EXC (03-14)	67,72 48,76
250 SX & SX M 250 EXC, E-XC E, EGS M cilindro nikasil	90-94	67,44 67,45 67,46	NX70040 NX70040-B NX70040-C	87,64	N09B0371	8,65	NX70040R	15,78	NX70040T	29,89	NX70040F	61,56
250 SX 250 EGS cilindro nikasil	1995 1995	67,44 67,45 67,46			N09B0371	8,65	NX70040R	15,78	NX70040T	29,89	NX70040F	61,56
250 SX, EXC, EGS, MXC cilindro nikasil	96-99	67,44 67,45 67,46	NX70047 NX70047-B NX70047-C	85,93	N09B0371	8,65	NX70040R	15,78	NX70040T	29,89	NX70040F	61,56
250 SX & SXS 250 EXC 250 MXC cilindro nikasil	00-02 00-06 00-05	66,34 66,35 66,36	NX70050 NX70050-B NX70050-C	84,52	N09B0371	8,65	NX70050R	7,96	NX70049T NX70050T EXC (2004) NX70051T EXC (2005)	35,48 29,76 31,11	NX70040F NX70050F EXC (2004) NX70051F EXC (2005)	61,56 48,24 59,35
250 SX & SXS 250 XC, XCW, XCW-E 250 EXT 2t 250 R Freeride cilindro nikasil	03-15 06-12 06-15 2014	66,34 66,35 66,36	NX70051 NX70051-B NX70051-C	93,66	N09B0371	8,65	NX70050R	7,96	NX70050T SX (03-04) NX70051T SX (05-06) XC, XC-W (2006) EXC 2t (06-07) NX70053T SXS (07) SX, XC (07-12) EXC 2t (08-15)	29,76 31,11 23,43	NX70050F SX (03-04) NX70051F SX (05-06) XC, XC-W (06) NX70053F SXS (2007) SX, XC (07-12) XC-W (07-12) EXC 2t (08-15)	48,24 59,35 53,32
250 EXC 4 t	01-06								NX70061T	52,58	NX70061F	96,48
250 SX-F 250 XC-F, XCF-W 250 EXC-F	05-12 07-13 07-13	75,96 75,97 75,98	NX70060 NX70060-B NX70060-C	170,47			NX70060R	19,01	NX70060T	67,11	NX70060F	109,49
250 SX-F 250 XC-F 250 EXC-F six days	13-14 13-14 2014								NX70065T	103,64	NX70065F	200,17
300 EXC, SX 300 XC, XC-W	90-03 90-07								NX70033T EXC, SX, XC (94-03) NX70034T XC, XCW (06-07)	23,13 22,85	NX70033F EXC, SX, XC (94-03) NX70034F XC, XCW (06-07)	55,06 54,15

** Pistón o aros Namura no son intercambiables por aros o pistones originales. / [En Azul pistones Hyperdryve.](#)

RUEDAS Y NEUMÁTICOS
MOTOR
ADMISIÓN / ESCAPE REFRIGERACIÓN
ELECTRICO
SUSPENSIÓN / DIRECCIÓN
FRENS
TRANSMISIÓN
CONTROLES Y MANDOS
CHASIS
ACCESORIOS

Kit de pistón y juntas



Kit juntas motor

			PISTÓN, SEGMENTOS, BULÓN, CIRCLIPS		RODAMIENTO PISTÓN		SEGMENTOS		JUNTAS CILINDRO		JUNTAS MOTOR	
300 EXC	04-16	74,94	NX70034					NX70034T	22,85	NX70034F	54,15	
300 XC	08-16	74,95	NX70034-B	121,31	N09B0371	8,65	NX70034R	22,85	EXC(04-05)	EXC(04-05)		
300 XC-W	08-16	74,96	NX70034-C					XC,XCW(06-07)	23,90	XC,XC-W(06-07)	57,41	
								NX70036T		NX70036F		
								XC, XC-W(08-15)		XC,XC-W(08-15)		
350 EXC-F	12-15		NX70062					NX70062T		NX70062F		
350 Freeride	11-15	87,96	NX70062-B	190,83			NX70062R	19,75	SX-F (11-13)	SX-F (11-13)	105,38	
350 SX-F	12-14	87,97	NX70062-C					EXC-F (12-13)	63,19	EXC-F (12-13)		
350 XC-F	2012	87,98						Freeride (13-14)		Freeride (13-14)		
350 XCF-W	12-14							XCF-W (2012)		XCF-W (2012)		
360 SX, EXC	96-97							NX70037T	22,52	NX70037F	54,15	
380 SX, EXC	98-02							NX70037T	22,52	NX70037F	54,15	
450 EXC	03-07											
450 SMS	2004											
450 MXC	2005							NX70038T	47,16	NX70038F	98,52	
450 XC-W	2007									EXC (04-06)		
										XC-W (2007)		
450 MXC	03-04											
450 SMR	05-07											
450 SX	03-06							NX70039T	48,57	NX70039F	98,52	
450 XS	05-06									MXC (03-04)		
450 XC	04-07									SMR (05-07)		
										SX (03-06)		
450 EXC	08-12	94,94	NX70068	179,03								
450 EXC-R	08-12	94,95	NX70068-B				NX70041R	19,98	NX70068T	66,67	NX70068F	91,45
		94,96	NX70068-C						EXC (09-11)	EXC (09-11)		
450 SX-F, SXS-F	07-12		NX70070	191,74								
450 XC-F	08-09		NX70070-B				NX70070R	19,98	NX70070T	64,43	NX70070F	82,22
			NX70070-C									
450 EXC, XC-W	12-13									NX70068T		
450 SX-F	2013									450 XC-W	66,67	NX70063F
500 EXC, XC-W	12-13									500 EXC, XC-W	66,67	450 XC-W
												500 EXC, XC-W
450 SX-F, XC-F	14-16											
450 SMR	2014									NX70072T	91,62	NX70072F
505 XC-F, SX-F, SX	08-09									NX70080T	62,50	NX70080F
520 SX, MXC, EXC	00-02									NX70039T	48,57	NX70039F
525 SX, MXC, EXC, XC	03-07									NX70039T	48,57	NX70039F
										EXC (03-07)	48,57	EXC (03-07)
										MXC, SX(03-07)	48,57	MXC, SX (03-07)
										XC (06-07)	48,57	XC (06-07)
530 EXC, XC-W	09-11									NX70068T	66,67	NX70063F

			PISTÓN, SEGMENTOS, BULÓN, CIRCLIPS		RODAMIENTO PISTÓN		SEGMENTOS		JUNTAS CILINDRO		JUNTAS MOTOR	
--	--	--	------------------------------------	--	-------------------	--	-----------	--	-----------------	--	--------------	--

RIEJU

125 PRO/SM Marathon	2009									NX40093T	32,23	NX40093F	79,13
---------------------	------	--	--	--	--	--	--	--	--	----------	-------	----------	-------

			PISTÓN, SEGMENTOS, BULÓN, CIRCLIPS		RODAMIENTO PISTÓN		SEGMENTOS		JUNTAS CILINDRO		JUNTAS MOTOR	
--	--	--	------------------------------------	--	-------------------	--	-----------	--	-----------------	--	--------------	--

SUZUKI

JR 50	78-07		NX30050	41,03	N09B0001	7,29	NX30050R	9,53	NX20055T	8,68	NX20055F	23,15	
			NX30050-2				NX30050-2R						
			NX30050-4				NX30050-4R						
RM 60 cilindro electrofusion	2003	42,95	NX20060	59,04	N09B0001	7,29	NX20060R	10,03	NX20060T	11,41	NX20060F	23,98	
		42,96	NX20060-B										
		42,97	NX20060-C										
RM 65 cilindro electrofusion	03-07	44,45	NX20065	59,04	N09B0431	7,82	NX20060-6R	10,03	NX20065T (03-05)	20,31	NX20065F (03-05)	34,04	
		44,46	NX20065-B				NX20060-6R						
		44,47	NX20065-C				NX20060-6R						
		44,96	NX20065-2				NX20065-2R						
		45,46	NX20065-4				NX20065-4R						
		45,95	NX20065-6				NX20065-6R						
RM 80**	91-01	47,43	NX30080	77,25	N09B0121	7,29	NX10080-2R	7,35	NX30080T	20,45	NX30080F	31,94	
		47,44	NX30080-B				NX10080-2R						
		47,45	NX30080-C				NX10080-2R						
		47,93	NX30080-2				NX30080-2R	10,49					
		48,43	NX30080-4				NX30080-4R						
		48,93	NX30080-6				NX30080-6R						
RM 85 cilindro SCEM	02-12	47,94	NX30085	74,82	N09B0121	7,29	NX20080-RA	9,91	NX30085T	21,27	NX30085F	53,60	
		47,95	NX30085-B										
		47,96	NX30085-C										
RM 100	03-04	52,44	NX20010	80,45	N09B0061	8,12	NX20010R	13,54	NX20010T	31,11			
		52,45	NX20010-B										
		52,46	NX20010-C										
DR-Z 110	03-05									NX20011T	28,46	NX20011F	48,78
DR 125	94-96									NX30010T	31,11	NX30007F	29,51
DR-Z 125 L	03-09									NX20007T	27,32	NX20007F	52,11

Kit de pistón y juntas



Kit juntas cilindro

			PISTÓN, SEGMENTOS, BULÓN, CIRCLIPS	RODAMIENTO PISTÓN	SEGMENTOS	JUNTAS CILINDRO	JUNTAS MOTOR									
RM 125 cilindro SCEM	89-00	53,94	NX30000	76,50	N09B0131	8,65	NX20000R	9,53	NX30000T (90-00)	23,37	NX30000F (92-97)	57,22				
		53,95	NX30000-B										10,98	NX10000-2R	NX30001F (98-00)	48,71
		53,96	NX30000-C													
		54,44	NX30000-2													
		54,94	NX30000-4													
55,44	NX30000-6															
RM 125	01-03	53,94	NX30004	74,93			NX20000R	9,53	NX30000T	23,37	NX30002F	48,71				
		53,95	NX30004-B													
		53,96	NX30004-C													
RM 125** cilindro nikasil	04-10	53,95	NX30002	68,96	N09B0131	8,65	NX20000R	9,53	NX30003T (04-07)	25,28	NX30003F	58,38				
		53,96	NX30002-B													
		53,97	NX30002-C													
DR 200	86-09								NX30011T	24,62	NX30011F	52,66				
DR-Z 250	01-07								NX30043T	39,09	NX30043F	59,23				
RM 250	84-85								NX30025T	13,73	NX30025F	35,14				
RM 250 cilindro SCEM	89-91	66,94	NX30025	98,11	N095031	9,70	NX30025R	16,80	NX30021T 1989	19,70	NX30021F 1989	55,70				
		66,95	NX30025-B										NX30022T 1990	20,00	NX30022F 1990	57,69
		66,96	NX30025-C													
RM 250 cilindro SCEM	92-95	66,94	NX30025	98,11	N095031	9,70	NX30025R	16,80	NX30026T (92-93)	15,03	NX30026F (92-93)	54,01				
		66,95	NX30025-B										NX30027T (94-95)	22,63	NX30027F (94-95)	54,01
		66,96	NX30025-C													
RM 250 cilindro SCEM	96-97	66,34	NX30026	102,20	N095031	9,70	NX10025R	14,56	NX30028T	15,67	NX30028F	61,56				
		66,35	NX30026-B													
		66,36	NX30026-C													
RM 250 cilindro SCEM	1998	66,35	NX30024	82,55	N095031	9,70	NX10025R	14,56	NX30028T	15,67	NX30028F	61,56				
		66,36	NX30024-B													
		66,37	NX30024-C													
RM 250 cilindro SCEM	1999	66,34	NX30026	102,20	N095031	9,70	NX10025R	14,56	NX30029T	19,67	NX30029F	51,64				
		66,35	NX30026-B													
		66,36	NX30026-C													
RM 250 cilindro SCEM	00-02	66,35	NX30024	82,55	N095031	9,70	NX10025R	14,56	NX30029T (2000)	19,67	NX30029F (2000)	51,64				
		66,36	NX30024-B										NX30030T (01-02)	19,67	NX30030F (01-02)	64,21
		66,37	NX30024-C													
RM 250 cilindro nikasil	03-10	66,34	NX30027	92,53	N095031	9,70	NX10025R	14,56	NX30031T (03-05)	32,55	NX30033F (03-08)	54,07				
		66,35	NX30027-B													
		66,36	NX30027-C													
		66,84	NX30027-2													
		67,34	NX30027-4													
		67,84	NX30027-6													
RMX 250	89-98								NX30035T	27,24	NX30035F	58,77				
RM-Z 250 piston forjado cilindro SCEM	04-06	76,95	NX20030	171,90			NX20030R	20,25	NX20030T	71,42	NX20030F	83,99				
		76,96	NX20030-B													
		76,97	NX20030-C													
RM-Z 250	07-09	77,00	NX30013	142,56			NX30013R	18,26	NX30038T	50,42	NX30039F	100,40				
		77,01	NX30013-B													
		77,02	NX30013-C													
RM-Z 250	10-14	77,00	NX30014	142,84			NX30013R	18,26	NX30039T	51,91	NX30039F	100,40				
		77,01	NX30014-B													
		77,02	NX30014-C													
DR-Z 400 compres. cilindro nikasil	00-16	89,96	NA30002	135,63			NA30002R	25,58	NA30002T	40,45	NX30041F	101,54				
		89,97	NA30002-B													
		89,98	NA30002-C													
		90,46	NA30002-2													
		90,96	NA30002-4													
		91,46	NA30002-6													
RM-Z 450	05-07		NX30015	171,93			NX30015R	24,37	NX30045T	61,03	NX30045F	114,19				
			NX30015-B													
			NX30015-C													
RM-Z 450 RMX 450	08-12 10-11		NX30016	180,19			NX30016R	24,37	NX30046T	70,81	NX30046F	130,05				
			NX30016-B													
			NX30016-C													
DR 650 SE	96-13								NX30049T	39,51	NX30049F	71,17				

** Pistón o aros Namura no son intercambiables por aros o pistones originales. / En Azul pistones Hyperdryve.



Kit de pistón y juntas

YAMAHA	Año	Medidas (mm)	PISTÓN, SEGMENTOS, BULÓN, CIRCLIPS		RODAMIENTO PISTÓN		SEGMENTOS		JUNTAS CILINDRO		JUNTAS MOTOR	
			Referencia	P.V.P.	Referencia	P.V.P.	Referencia	P.V.P.	Referencia	P.V.P.	Referencia	P.V.P.
PW 50 compres.	81-14	39,96	NX40005	62,16	N09B410	4,37	NX40005R	12,20	NX40055T	4,97	NX40055F	10,94
		40,21	NX40005-1									
		40,46	NX40005-2									
		40,71	NX40005-3									
		40,96	NX40005-4									
41,21	NX40005-5											
41,40	NX40005-6											
BW 80 PW 80 compres. 6.6:1	86-90 83-06	46,97	NX40008	57,55	N09B0422	7,29	NX40008R	11,24	NX40008T	11,69	NX40008F	23,21
		47,47	NX40008-2									
		47,97	NX40008-4									
		48,47	NX40008-6									
YZ 80 compres. 8.2:1 cilindro ceramico	93-01	46,95	NX40080	72,17	N09B0121	7,29	NX10080R	7,35	NX40080T	11,69	NX40080F	24,45
		46,96	NX40080-B									
		46,97	NX40080-C									
		47,44	NX40080-2									
		48,00	NX40080-4									
48,50	NX40080-6											
YZ 85 compres. 8.2:1 cilindro ceramico	02-16	47,44	NX40080-2	72,17	N09B0121	7,29	NX10080-2R	7,35	NX40085T	15,09	NX40085F	36,22
		47,45	NX40080-2B									
		47,46	NX40080-2C									
		48,00	NX40080-4									
48,50	NX40080-6											
DTR 125 R	91-06	55,95	NX40011	46,50			NX40011R	10,03				
		56,20	NX40011-1									
		56,45	NX40011-2									
		56,70	NX40011-3									
		56,95	NX40011-4									
		57,45	NX40011-6									
57,95	NX40011-8											
WR 125 R WR 125 X	09-11 09-11								NX40093T	35,61	NX40093F	87,44
YZ 125	86-88								NX40001T	12,38	NX40001F	39,43
YZ 125	1989								NX40002T	12,38	NX40003F	39,43
YZ 125	90-91								NX40003T	12,38	NX40003F	39,43
YZ 125	92-93								NX40004T	17,93	NX40004F	40,61
YZ 125	94-96								NX40005T	16,91	NX40005F	41,89
YZ 125 compres. 8.9:1 cilindro ceramico	97-01	53,94	NX10003	68,49	N09B0381 (98-00) N09B0011 (2001)	8,65 7,29	NX20000R	9,53	NX40005T (1997) NX40000T (98-01)	16,91	NX40000F	41,77
		53,95	NX10003-B									
		53,96	NX10003-C									
YZ 125** compres. 10.8:1 cilindro ceramico	02-04	53,94	NX40001	79,43	N09B0011	7,29	NX20000R	9,53	NX40007T	20,80	NX40007F	42,66
		53,95	NX40001-B									
		53,96	NX40001-C									
YZ 125** compres. 10.7:1 cilindro ceramico	05-15	53,95	NX40009	68,96	N09B0011	7,29	NX20000R	9,53	NX40009T	24,06	NX40009F	40,97
		53,96	NX40009-B									
		53,97	NX40009-C									
TT-R 125	05-13								NA40020T	34,23	NA40020F	58,65
TW 200	87-11	67,00							NX40020T	34,23	NX40020F	58,65
TTR 225	99-04								NX40022T	35,25	NX40022F	64,21
XT 225	93-07								NX40022T	35,25	NX40022F	64,21
TTR 230	05-12								NX40022T	35,25	NX40022F	64,21
WR 250 compres. 10.6:1 cilindro ceramico	92-98	67,94	NX40026	96,15	N095031	9,70	NX40026R	19,48	NX40026T (90-94) NX40029T (95-98)	24,45	NX40026F (90-94) NX40029F (95-98)	44,29 45,28
		67,95	NX40026-B									
		67,96	NX40026-C									
WR 250 F	01-02								NX40032T	43,29	NX40032F	64,02
WR 250 F	03-13								NX40032T	43,29	NX40036F	66,14
YZ 250 compres. 10.6:1 cilindro ceramico	92-98	67,94	NX40026	96,15	N095031	9,70	NX40026R	19,48	NX40026T (90-94) NX40029T (95-98)	24,45	NX40026F (90-94) NX40029F (95-98)	44,29 45,28
		67,95	NX40026-B									
		67,96	NX40026-C									
YZ 250 compres. 10.9:1 cilindro ceramico	99-16	66,35	NX40025	91,78	N095051	9,70	NX10025R	14,56	NX40025T (99-01) NX40031T (02-14)	17,41	NX40025F (99-00) NX40031F (02-14)	43,52 52,11
		66,36	NX40025-B									
		66,37	NX40025-C									
		66,85	NX40025-2									
		67,35	NX40025-4									
		67,85	NX40025-6									

** Pistón o aros Namura no son intercambiables por aros o pistones originales. / En Azul pistones Hyperdryve.



Kit de pistón y juntas



		PISTÓN, SEGMENTOS, BULÓN, CIRCLIPS		RODAMIENTO PISTÓN	SEGMENTOS		JUNTAS CILINDRO		JUNTAS MOTOR		
WR 250 F	01-02						NX40032T	43,29	NX40032F	64,02	
WR 250 F	03-04						NX40032T	43,29	NX40036F	66,14	
WR 250 F	05-13	76,94 76,95 76,96	NX40033 NX40033-B NX40033-C	174,78		NX20030R	15,58	NX40032T	43,29	NX40036F	66,14
YZ 250 F	01-04						NX40032T	43,29	NX40032F	64,02	
YZ 250 F	05-13	76,94 76,95 76,96	NX40033 NX40033-B NX40033-C	174,78		NX20030R	15,58	NX40032T	43,29	NX40032F	64,02
WR 400 F	98-99						NX40040T	52,52	NX40040F	79,35	
WR 400 F	2000						NX40041T	54,37	NX40041F	82,75	
YZ 400 F	98-99						NX40040T	52,52	NX40040F	79,35	
WR 426 F	01-02						NX40041T	54,37	NX40041F	82,75	
YZ 426 F	00-02						NX40041T	54,37	NX40041F	82,75	
WR 450 F	03-06	94,96	NX40045	179,75							
YZ 450 F	03-05	94,97 94,98	NX40045-B NX40045-C		NA40009R	25,39	NA40009T YZ (03-05)	55,23	NX40045F	81,64	
WR 450 F	07-14	94,96	NX40045	179,75							
YZ 450 F	06-09	94,97 94,98	NX40045-B NX40045-C		NA40009R	25,39	NX40046T	44,37	NX40046F	73,19	
YZ 450 F	10-13	94,95 94,96 94,97	NX40046 NX40046-B NX40046-C	178,84		NX40046R	31,22	NX40047T	62,33	NX40047F	104,04
YZ 450 F	14-16						NX40048T	99,93	NX40048F	143,64	
TT 660 R	84-04	95,00	NA40007	123,53		NA40007R	25,58	NA40007T (84-96)	60,81	NA40007F (84-96)	110,24
XT 600		95,50	NA40007-2		NA40007-2R						
XTZ 600		96,00	NA40007-4		NA40007-4R						
XTZ 660	91-98	99,97 100,47 100,97 101,47	NA40004 NA40004-2 NA40004-4 NA40004-6	123,94		NA40004R NA40004-2R NA40004-4R NA40004-6R	27,79				

Rascador de juntas



Referencia	P.V.P.
DUP12290	6,84



RUEDAS Y NEUMÁTICOS

MOTOR

ADMISIÓN / ESCAPE
REFRIGERACIÓN

ELECTRICO

SUSPENSIÓN / DIRECCIÓN

FRENOS

TRANSMISIÓN

CONTROLES Y MANDOS

CHASIS

ACCESORIOS



Pistones y juntas

Elementos creados específicamente para competición, con los que dotar a tu máquina de las mejores prestaciones.

Namura, marca especializada en la fabricación de pistones, se ha posicionado de una forma brutal en el mercado, extendiendo, los últimos años, sus productos en varios continentes, consiguiendo una impresionante aceptación (por parte del gran público) por ser un producto de altísima calidad con una excelente relación calidad/precio. Sin pasar por alto la gran mejora de prestaciones que estos elementos ofrecen al conjunto.

El esfuerzo del fabricante se ha centrado básicamente en satisfacer las necesidades de los pilotos y usuarios más exigentes de Mx y ATV, ofreciendo un extenso catálogo en el que además de pistones encontramos juntas.



¿Cómo ser referentes?

Como bien sabemos el pistón tiene uno de los trabajos más duros del motor, conectando la energía térmica con la mecánica, a ello que este sea uno de los componentes que debemos tener más en cuenta de todo el conjunto. Para conseguir un producto realmente distinguido del resto, el aluminio recibe un tratamiento especial (en forma de baño) en uno de los últimos pasos del proceso de fabricación. Con ello se dota a estos pistones de unas características muy especiales:

- Mayor dureza. Un pistón original dispone de una dureza de 60 HRB mientras que los pistones Namura ofrecen una dureza de 105 HRB. Ello supone un incremento de la dureza de un 75%
- Se minimiza la dilatación y la contracción del pistón
- Una mayor resistencia al calor
- Se reduce el coeficiente de fricción

MOS2 (tratamiento de Teflón/Molybdenum)

En el último eslabón del proceso de fabricación los pistones Namura reciben un revestimiento a base de Teflón y Molybdenum (un tratamiento anti-fricción), con el que se consigue mejorar aún más las cualidades de este producto.

- Reducción del desgaste
- Protección a la corrosión
- Mejora la durabilidad
- Ofrece lubricación permanente (ideal para condiciones extremas)

*Cuando adquirimos un pistón Namura u otro de sus productos, adquirimos un compromiso directo con el fabricante, quien nos ofrece un producto más duradero, con impresionantes prestaciones y menor mantenimiento.



Pistón Hyperdryve

La nueva línea de pistones Hyperdryve está compuesta de un nuevo aluminio hyper-eutectico desarrollado por la Nasa y manipulado para mantener su alta fuerza de tensión hasta 370°C, un 50% más resistente que un pistón de fundición convencional. Esto da Hyperdryve, la fuerza para funcionar bajo condiciones de funcionamiento normalmente reservadas para pistones forjados.

Los resultados del porque Namura Hyperdryve es el próximo paso en la evolución de pistones de deportes de motor son claros.

Comparacion de Namura Hyperdryve con un típico pistón forjado de aluminio 4032

	Clasificación HRB Temperatura ambiente (Dureza)	Límite de fluencia Temp.perm.a 370° (MPa)	Fuerza de tensión máxima Temp.perm.a 370° (MPa)
Hyperdryve	72	76	97
4032 Forjado	70	31	44

Este aluminio evolutivo combinado con nuestras características ya existentes de cabezas anodizadas* lisas y maquinadas (para mejor reflejo de calor), y faldas recubiertas de MOS2 (dándote arrancadas y frenadas más suaves), concentra las demandas actuales de motores de 4 tiempos 450cc y de 2 tiempos 250cc de altas revoluciones (motores de cross y enduro), a un precio competitivo por debajo de la competencia.

Además de las características y ventajas del pistón habrá una nueva presentación exclusiva para los pistones Hyperdryve Namura. En bote cilíndrico ofreciendo una fácil apertura, de rosca en la parte superior: Dentro están los compartimentos de espuma de protección individuales sosteniendo el pistón, pin, clips y aros junto con un folleto informativo que enumera las características y ventajas de los pistones Hyperdryve.

Kit de cilindro STD o con aumento de cilindrada. Cilindros, pistones y juntas de recambio

Lo más rápido, fiable y económico, sustituir el cilindro y pistón por el kit de cilindrada, ahorrarás tiempo y dinero, pero también aumentarás cilindrada, convirtiendo tu vieja moto en un vehículo con nuevas prestaciones. El pistón Namura supera ampliamente las características y calidades originales. Los cilindros pueden ser normales, de nikasil o cerámicos, según sea el original, como mínimo de la misma calidad que el original. El Kit se entrega con cilindro, pistón, segmentos, bulón, circlips y kit de juntas.

* DAT09463K Es necesario mandrinar 0,8mm el cárter para poder alojar la camisa.

** DAT094621K Usar la junta de culata delgada (la gruesa solo para Quad).



HONDA
XR400



GAS GAS	Año	Descripción	KIT DE CILINDRO		CILINDRO DE RECAMBIO		KIT PISTÓN RECAMBIO		JUNTAS RECAMBIO	
			Referencia	P.V.P.	Referencia	P.V.P.	Referencia	P.V.P.	Referencia	P.V.P.
EC 250 F	10-15	77 mm	DMX091502K	341,44	DMX091502	167,69				
HONDA										
CRF 250 R	04-09	Std. 78 mm (249cc)	DMX09152K	341,44	DMX09152	167,69				
CRF 250 R	04-09	82 mm (de 249 a 290cc)			DMX091522	208,87				
CRF 250 X	04-15	Std. 78 mm (249cc)	DMX09152K	341,44	DMX09152	167,69				
CRF 250 X	04-09	82 mm (de 249 a 290cc)			DMX091522	208,87				
XR 400	96-04	89 mm (de 400 a 440cc)	DAT09463K*	308,12			NA10004	123,25	NA10004T	52,66
CRF 450 R	02-06	Std. 96 mm	DMX09158K	394,98	DMX09158	209,62				
CRF 450 R	07-08	Std. 96 mm	DMX09149K		DMX09158	209,62				
CRF 450 R	02-08	dimensionado 100 mm			DMX091581	233,03				
KAWASAKI										
KLX 400	03-05	94 mm (de 400 a 435cc)	DAT094621K**	361,87			NA30002-16	138,06	NA3000216T	78,60
							NA3000216B	138,06	NA3000216T	78,60
							NA3000216C	138,06	NA3000216T	78,60
SUZUKI										
DR-Z 400	00-15	94 mm (de 400 a 435cc)	DAT094621K**	361,87			NA30002-16	138,06	NA3000216T	78,60
							NA3000216B	138,06	NA3000216T	78,60
							NA3000216C	138,06	NA3000216T	78,60
YAMAHA										
WR 125 R	08-12	Std. 52 mm			DMX09155					
WR 125 X	08-12	Std. 52 mm			DMX09155					
YFZ-R 125	08-12	Std. 52 mm			DMX09155					
WR 250 F	01-13	Std. 77 mm (250cc)	DMX091502K	341,44	DMX091502	167,69			NX40032T	43,29
WR 250 F	01-13	83 mm (de 250 a 290cc)			DMX09150	208,87			NX4003224T	84,38
YZ 250 F	01-04	Std. 77 mm (250cc)			DMX091502	167,69				
YZ 250 F	01-04	83 mm (de 250 a 290cc)			DMX09150	208,87				
YZ 250 F	05-13	Std. 77 mm (250cc)	DMX091502K	341,44	DMX091502	167,69			NX40032T	43,29
YZ 250 F	05-13	83 mm (de 250 a 290cc)			DMX09150	208,87			NX4003224T	84,38
WR 450 F	03-06	Std. 95 mm (449cc)	DMX09151K	394,98	DMX09151	209,62				
WR 450 F	03-06	98 mm (de 449 a 478cc)			DMX091511	233,03				
WR 450 F	07-15	Std. 95 mm (449cc)	DMX09159K	394,98	DMX09159	220,86				
WR 450 F	07-15	98 mm (de 449 a 478cc)			DMX091591	233,03				
YZ 450 F	03-05	Std. 95 mm (449cc)	DMX09151K	394,98	DMX09151	209,62				
YZ 450 F	03-05	98 mm (de 449 a 478cc)			DMX091511	233,03				
YZ 450 F	06-09	Std. 95 mm (449cc)	DMX09159K	394,98	DMX09159	220,86				
YZ 450 F	06-09	98 mm (de 449 a 478cc)			DMX091591	233,03				

RUEDAS Y NEUMÁTICOS

MOTOR

ADMISIÓN / ESCAPE
REFRIGERACIÓN

ELÉCTRICO

SUSPENSIÓN / DIRECCIÓN

FRENOS

TRANSMISIÓN

CONTROLES Y MANDOS

CHASIS

ACCESORIOS



Válvulas de admisión y escape racing

Válvulas de acero inoxidable forjadas y extremadamente ligeras de calidad superior a las originales. Para nuestras válvulas racing recomendamos el montaje de nuestros muelles Pag. 30. Se sirven en cajas de una unidad.



BETA	VÁLVULAS DE ADMISIÓN			VÁLVULAS DE ESCAPE	
	Año	Referencia	P.V.P.	Referencia	P.V.P.
RR 400 Enduro	05-09	DXU09548i	26,23	DXU09548E	25,40
RR 450 Enduro	05-09	DXU09548i	26,23	DXU09548E	25,40
RR 525 Enduro	05-09	DXU09548i	26,23	DXU09548E	25,40

GAS GAS	VÁLVULAS DE ADMISIÓN			VÁLVULAS DE ESCAPE	
	Año	Referencia	P.V.P.	Referencia	P.V.P.
EC 250 F	10-15	DXU09519i* DXU09522i	24,61 24,61	DXU09519E	23,78
EC 300 F	13-15	DXU09519i* DXU09522i	24,61 24,61	DXU09519E	23,78
EC 450 F	13-15	DXU09521i* DXU09524i	24,61 25,40	DXU09521E	25,08

HONDA	VÁLVULAS DE ADMISIÓN			VÁLVULAS DE ESCAPE	
	Año	Referencia	P.V.P.	Referencia	P.V.P.
CRF 150 F	03-05	DXU09543i	24,61	DXU09543E	23,78
CRF 150 F	06-15	DXU09544i	24,61	DXU09544E	23,78
CRF 150 R	07-15	DXU09545i	25,08	DXU09545E	25,08
CRF 230 F	03-15	DXU09543i	24,61	DXU09543E	23,78
CRF 230 L	03-15	DXU09543i	24,61	DXU09543E	23,78
CRF 250 R	04-07	DXU09526i	24,57	DXU09502E	24,29
CRF 250 R	08-09	DXU09526i	24,57	DXU09526E	25,40
CRF 250 R	10-15	DXU09532i	23,78	DXU09532E	25,40
CRF 250 X	04-09	DXU09526i	24,57	DXU09502E	24,29
CRF 450 R	02-06	DXU09502i	26,44	DXU09534E	23,78
CRF 450 R	07-08	DXU09502i	26,44	DXU09501E	23,78
CRF 450 R	09-12	DXU09533i	24,29	DXU09533E	23,78
CRF 450 R	13-15	DXU09533i	24,29	DXU09546E	24,61
CRF 450 X	05-09	DXU09503i	24,61	DXU09503E	24,29

HUSABERG	VÁLVULAS DE ADMISIÓN			VÁLVULAS DE ESCAPE	
	Año	Referencia	P.V.P.	Referencia	P.V.P.
FE 250	2013	DXU09550i	25,08	DXU09550E	24,29
FE 450	04-08	DXU09548i	26,23	DXU09548E	25,40
FE 550	04-08	DXU09548i	26,23	DXU09548E	25,40
FE 650	04-08	DXU09548i	26,23	DXU09548E	25,40
FS 650	04-08	DXU09548i	26,23	DXU09548E	25,40

KAWASAKI	VÁLVULAS DE ADMISIÓN			VÁLVULAS DE ESCAPE	
	Año	Referencia	P.V.P.	Referencia	P.V.P.
KX 250 F	04-06	DXU09509i	24,29	DXU09509E	26,15
KX 250 F	07-08	DXU09552i	24,50	DXU09509E	26,15
KX 250 F	09-15	DXU09515i	24,29	DXU09509E	26,15
KX 450 F	06-08	DXU09164i	21,16	DXU09164E	20,53
KX 450 F	09-15	DXU09528i	24,29	DXU09528E	23,78

KTM	VÁLVULAS DE ADMISIÓN			VÁLVULAS DE ESCAPE	
	Año	Referencia	P.V.P.	Referencia	P.V.P.
250 EXC-F	07-12	DXU09550i	25,08	DXU09550E	24,29
250 SX-F	05-13	DXU09550i	25,08	DXU09550E	24,29
450 EX-C	03-07	DXU09548i	26,23	DXU09548E	25,40
520 SX	00-02	DXU09548i	26,23	DXU09548E	25,40
525 SX	03-07	DXU09548i	26,23	DXU09548E	25,40

SUZUKI	VÁLVULAS DE ADMISIÓN			VÁLVULAS DE ESCAPE	
	Año	Referencia	P.V.P.	Referencia	P.V.P.
RMZ 250	04-06	DXU09509i	24,29	DXU09509E	24,29
RMZ 250	07-09	DXU09530i	25,40	DXU09530E	25,40
RMZ 250	10-15	DXU09531i	25,40	DXU09530E	25,40
RM-Z 450	05-06	DXU09536i	24,61	DXU09536E	23,78
RM-Z 450	2007	DXU09535i	24,61	DXU09535E	23,78
RM-Z 450	08-15	DXU09527i	24,29	DXU09527E	23,78
RMX 450	10-11	DXU09527i	24,29	DXU09527E	23,78

YAMAHA	VÁLVULAS DE ADMISIÓN			VÁLVULAS DE ESCAPE	
	Año	Referencia	P.V.P.	Referencia	P.V.P.
WR 250 F	01-13	DXU09519i* DXU09522i	24,61 24,61	DXU09519E	23,78
YZ 250 F	01-13	DXU09519i* DXU09522i	24,61 24,61	DXU09519E	23,78
YZ 250 F	14-15	DXU09553i	24,29	DXU09553E	23,78
WR 450 F	03-15	DXU09521i* DXU09524i	24,61 25,40	DMX09521E	25,08
YZ 450 F	03-09	DXU09521i* DXU09524i	24,61 25,40	DMX09521E	25,08
YZ 450 F	10-13	DXU09541i	25,40	DXU09541E	24,61
YZ 450 F	14-15	DXU09554i	25,40	DXU09554E	24,61

* Válvula admisión central



Válvulas de admisión y escape

Válvulas ligeras de calidad superior o igual a las originales. Se sirven en cajas de una unidad.

HONDA	VÁLVULAS DE ADMISIÓN			VÁLVULAS DE ESCAPE	
	Año	Referencia	P.V.P.	Referencia	P.V.P.
CRF 70 F	04-12	DAU09000i1	16,65	DAU09000E1	19,22
XR 70 R	97-03	DAU09000i1	16,65	DAU09000E1	19,22
XR 200 R	80-02	DXU09500i	18,03	DXU09500E	18,03
XR 400 R	96-08	DAU09011i	19,30	DAU09011E	22,95
XL 600 R	83-84	DXU09504i	23,33	DXU09504E	23,33
XL 600 R	85-00	DXU09504i	23,33	DXU09504E	23,33
XR 600 R	83-00	DXU09504i	23,33	DXU09504E	23,33
XR 650 L	93-14	DXU09504i	23,33	DXU09504E	23,33

KAWASAKI	VÁLVULAS DE ADMISIÓN			VÁLVULAS DE ESCAPE	
	Año	Referencia	P.V.P.	Referencia	P.V.P.
KLR 250	85-05	DAU09022i	18,50	DAU09022E	21,35
KLX 400 R	03-05	DAU09025i	18,90	DAU09025E1	23,75

SUZUKI	VÁLVULAS DE ADMISIÓN			VÁLVULAS DE ESCAPE	
	Año	Referencia	P.V.P.	Referencia	P.V.P.
DR 350	90-00	DAU09033i	19,10	DAU09033E	22,00
DR 350 S	90-93	DAU09033i	19,10	DAU09033E	22,00
DR 350 SE	94-99	DAU09033i	19,10	DAU09033E	22,00
DR-Z 400	00-06	DAU09025i	18,90	DAU09025E	23,75
DR-Z 400 E	00-07	DAU09025i	18,90	DAU09025E	23,75
DR-Z 400 S	00-14	DAU09025i	18,90	DAU09025E	23,75
DR 650 SE	96-14	DAU09032i	18,50	DAU09032E	24,35

YAMAHA	VÁLVULAS DE ADMISIÓN			VÁLVULAS DE ESCAPE	
	Año	Referencia	P.V.P.	Referencia	P.V.P.
TW 200	87-14	DXU09518i2	18,58	DXU09518E2	20,29
XT 200	82-83	DXU09518i2	18,58	DXU09518E2	20,29
TT 225	86-87	DXU09518i2	18,58	DXU09518E2	20,29
TT 225	1999	DXU09518i2	18,58	DXU09518E2	20,29
TT-R 225	00-04	DXU09518i2	18,58	DXU09518E2	20,29
XT 225	92-07	DXU09518i2	18,58	DXU09518E2	20,29
TT-R 230	05-14	DXU09518i2	18,58	DXU09518E2	20,29
XT 250	09-10	DXU09518i2	18,58		

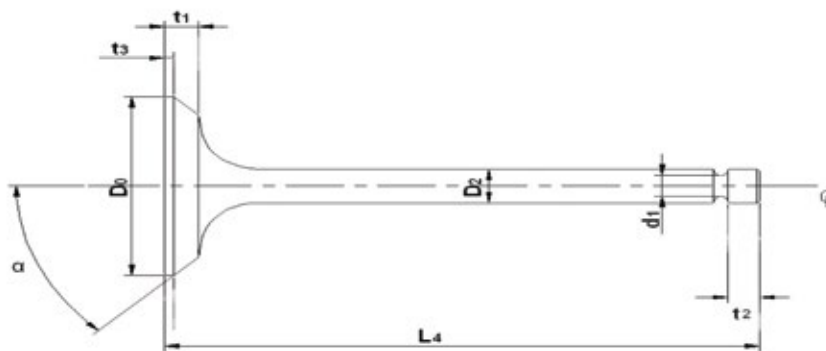

Especificaciones válvulas

Tolerancia (mm)	+/-0.10	----	+/-0.20	+/-0.01	+/-0.15	+/-0.20	+/-0.05	+/-0.10
Referencia	D0	α	L4	D2	t3	t1	d1	t2
DXU09500E	25mm	45°	91.5mm	5.4mm	1.3mm	2.7mm	4.55mm	6.0mm
DXU09500I	30mm	45°	92mm	5.46mm	1.1mm	2.7mm	4.55mm	6.0mm
DXU09501E	30mm	45°	84.3mm	4.98mm	1.0mm	2.3mm	4.3mm	1.5mm
DXU09502E	26mm	45°	82.1mm	4.96mm	1.0mm	2.7mm	4.2mm	1.5mm
DXU09502I	36mm	45°	84.75mm	5.49mm	1.5mm	2.9mm	4.7mm	1.5mm
DXU09503E	30mm	45°	84.5mm	4.97mm	1.2mm	2.7mm	4.3mm	1.5mm
DXU09503I	35mm	45°	84.6mm	5.45mm	1.0mm	2.7mm	4.75mm	1.5mm
DXU09504E	31mm	45°	104.2mm	6.56mm	1.8mm	3.5mm	5.45mm	3.2mm
DXU09504I	36mm	45°	105.6mm	6.58mm	1.0mm	3.3mm	5.5mm	5.7mm
DXU09509E	25mm	45°	79.2mm	4.46mm	1.0mm	2.3mm	3.8mm	1.5mm
DXU09509I	31mm	45°	79mm	4.48mm	1.0mm	2.5mm	3.8mm	1.5mm
DXU09515I	31mm	45°	79.3mm	4.47mm	1.0mm	2.5mm	3.75mm	1.5mm
DXU09519E	24.5mm	45°	77.9mm	4.46mm	1.0mm	2.1mm	3.5mm	2.1mm
DXU09519I	23mm	45°	78.6mm	3.99mm	0.8mm	2.1mm	2.9mm	1.5mm
DXU09521E	28mm	45°	75mm	4.96mm	1.0mm	2.8mm	4.1mm	1.8mm
DXU09521I	27mm	45°	76.3mm	4.48mm	1.0mm	2.7mm	3.46mm	1.8mm
DXU09522I	23mm	45°	80.1mm	3.98mm	1.0mm	2.2mm	3.0mm	1.5mm
DXU09524I	27mm	45°	77.2mm	4.9mm	1.0mm	2.7mm	3.48mm	2.0mm
DXU09526E	26mm	45°	82.2mm	4.46mm	1.0mm	2.5mm	3.8mm	1.5mm
DXU09526I	31mm	45°	83.4mm	4.97mm	1.0mm	2.3mm	4.2mm	1.5mm
DXU09527E	31mm	45°	80.9mm	5.46mm	1.0mm	3.0mm	4.6mm	2.0mm
DXU09527I	35.9mm	45°	81.9mm	5.48mm	1.0mm	3.0mm	4.6mm	2.0mm
DXU09528E	31mm	45°	77mm	5.46mm	1.2mm	3.0mm	4.65mm	2.0mm
DXU09528I	36mm	45°	78.2mm	5.47mm	1.2mm	2.8mm	4.7mm	2.0mm
DXU09530E	25mm	45°	80.7mm	4.46mm	1.0mm	2.3mm	3.55mm	2.1mm
DXU09530I	30.9mm	45°	80.4mm	4.47mm	1.0mm	2.7mm	3.5mm	2.1mm
DXU09531I	31mm	45°	80.2mm	4.48mm	1.0mm	2.7mm	3.55mm	1.5mm
DXU09532E	25mm	45°	84.2mm	4.46mm	1.0mm	2.3mm	3.8mm	1.2mm
DXU09532I	30.5mm	45°	89.1mm	4.98mm	1.0mm	2.5mm	4.2mm	1.2mm
DXU09533E	30mm	45°	80.6mm	4.97mm	1.2mm	2.5mm	4.2mm	1.2mm
DXU09533I	36mm	45°	78.65mm	4.98mm	1.2mm	3.1mm	4.2mm	1.2mm
DXU09534E	31mm	45°	84.3mm	4.97mm	1.0mm	2.7mm	4.2mm	1.5mm
DXU09535E	29mm	45°	81.4mm	5.46mm	1.2mm	2.3mm	4.55mm	2.0mm
DXU09535I	36mm	45°	82.5mm	5.48mm	1.2mm	3.0mm	4.55mm	2.0mm
DXU09536E	29mm	45°	81.3mm	4.98mm	1.1mm	2.7mm	4.0mm	1.8mm
DXU09536I	36mm	45°	82.5mm	4.98mm	1.1mm	2.7mm	4.0mm	1.8mm
DXU09541E	29.95mm	45°	85.95mm	5.39mm	1.2mm	2.8mm	4.6mm	1.8mm
DXU09541I	35.98mm	45°	83.68mm	5.42mm	1.1mm	3mm	4.55mm	1.8mm
DXU09543E	27.00mm	45°	89.35mm	5.34mm	1.3mm	3.0mm	4.75mm	2.6mm
DXU09543I	31.46mm	45°	89.7mm	5.40mm	0.8mm	2.3mm	4.75mm	2.8mm
DXU09544E	25.90mm	45°	82.63mm	4.94mm	1.0mm	2.5mm	4.3mm	1.8mm
DXU09544I	29.33mm	45°	83.4mm	4.89mm	0.8mm	2.2mm	4.3mm	1.8mm
DXU09545E	22.50mm	45°	79.95mm	4.40mm	0.8mm	2.2mm	3.8mm	1.0mm
DXU09545I	25.92mm	45°	77.98mm	4.44mm	1.0mm	2.3mm	3.8mm	1.5mm
DXU09546E	30.95mm	45°	80.50mm	4.89mm	1.0mm	2.7mm	4.3mm	1.4mm
DXU09548E	29.96mm	45°	96.92mm	5.92mm	1.2mm	2.8mm	5.0mm	1.5mm
DXU09548I	35.01mm	45°	96.99mm	5.92mm	1.1mm	3.0mm	4.9mm	1.5mm
DXU09550E	26.60mm	45°	92.90mm	4.91mm	1.1mm	2.5mm	3.9mm	1.4mm
DXU09550I	30.99mm	45°	99.49mm	4.89mm	1.0mm	2.5mm	3.95mm	1.2mm
DXU09552I	30.98mm	45°	79.13mm	4.49mm	0.8mm	1.8mm	3.8mm	1.2mm
DXU09164E	31.00mm	45°	81.99mm	5.36mm	1.0mm	2.6mm	4.6mm	1.8mm
DXU09164I	35.94mm	45°	83.29mm	5.39mm	0.9mm	2.6mm	4.6mm	1.8mm



Muelles para válvulas racing

Muelles reforzados con tratamiento de calor para aumentar la durabilidad. Se sirven en cajas de una unidad.

GAS GAS	Año	Admisión	P.V.P	Escape	P.V.P
EC 250 F	10-15	DXU09519IS	4,67	DXU09519ES	4,78
EC 300 F	13-15	DXU09519IS	4,67	DXU09519ES	4,78
EC 450 F	13-15	DXU09521S	4,78	DXU09521S	4,78

HONDA	Año	Admisión	P.V.P	Escape	P.V.P
CRF 150 F	03-05	DXU09543S	17,30	DXU09543S	17,30
CRF 150 F	06-15	DXU09544S	6,04	DXU09544S	6,04
CRF 150 R	07-15	DXU09545IS	5,74	DXU09545ES	6,11
CRF 230 F	03-15	DXU09543S	17,30	DXU09543S	17,30
CRF 230 L	08-09	DXU09543S	17,30	DXU09543S	17,30
CRF 250 R	04-07	DXU09526IS	5,15	DXU09503ES	6,33
CRF 250 R	08-09	DXU09526IS	5,15	DXU09526ES	5,08
CRF 250 R	10-15	DXU09532IS	5,30	DXU09532ES	5,81
CRF 250 X	04-09	DXU09526IS	5,15	DXU09503ES	6,33
CRF 450 R	02-08	DXU09502IS	5,63	DXU09502ES	5,81
CRF 450 R	09-15	DXU09533IS	5,63	DXU09533ES	6,00
CRF 450 X	05-09	DXU09503IS	9,31	DXU09537ES	10,05

HUSABERG	Año	Admisión	P.V.P	Escape	P.V.P
FE 250	2013	DXU09551ES	5,37	DXU09551ES	5,37

KAWASAKI	Año	Admisión	P.V.P	Escape	P.V.P
KX 250 F	04-05	DXU09509IS	5,15	DXU09509ES	5,19
KX 250 F	2006	DXU09509IS	5,15	DXU09505ES	5,67
KX 250 F	07-08	DXU09552IS	5,92	DXU09505ES	5,67
KX 250 F	09-10	DXU09540IS	4,75	DXU09505ES	5,67
KX 250 F	11-15	DXU09539IS	4,86	DXU09505ES	5,67
KX 450 F	09-15	DXU09528IS	5,41	DXU09528ES	5,10

KTM	Año	Admisión	P.V.P	Escape	P.V.P
250 EXC-F	2007	DXU09550IS	9,27	DXU09550ES	9,27
250 EXC-F	08-12	DXU09551IS	5,89	DXU09551ES	5,37
250 SX-F	05-07	DXU09550IS	9,27	DXU09550ES	9,27
250 SX-F	08-13	DXU09551IS	5,89	DXU09551ES	5,37

SUZUKI	Año	Admisión	P.V.P	Escape	P.V.P
RM-Z 250	04-06	DXU09509IS	5,15	DXU09509ES	5,19
RM-Z 250	07-15	DXU09529IS	4,67	DXU09509ES	5,19
RM-Z 450	05-07	DXU09536IS	5,30	DXU09536ES	5,81
RM-Z 450	08-15	DXU09527IS	5,41	DXU09527ES	5,15
RMX 450	10-11	DXU09527IS	5,41	DXU09527ES	5,15

YAMAHA	Año	Admisión	P.V.P	Escape	P.V.P
WR 250 F	01-13	DXU09519IS	4,67	DXU09519ES	4,78
YZ 250 F	01-12	DXU09519IS	4,67	DXU09519ES	4,78
YZ 250 F	14-15	DXU09553IS	6,37	DXU09553ES	6,11
WR 450 F	03-15	DXU09521S	4,78	DXU09521S	4,78
YZ 450 F	03-09	DXU09521S	4,78	DXU09521S	4,78
YZ 450 F	10-13	DXU09541IS	5,37	DXU09541ES	4,56
YZ 450 F	14-15	DXU09541ES	4,56	DXU09541IS	5,37



Especificaciones de muelles

Referencia	Exterior x Interior x Grosor	Altura	nº Espirales
DXU09502ES	23,5 x 16,5 x 3,6	41,5	7
DXU09502IS	23,7 x 16,5 x 3,6	38,5	6,4
DXU09503ES	20 x 13 x 3,3	42,8	9
DXU09503IS	16 x 12 x 2	36,5	7
DXU09505ES	17,85 x 13 x 2,4	45,45	10
DXU09509ES	20 x 14 x 3	38,5	7
DXU09509IS	20,2 x 14,2 x 3	39	7,3
DXU09519ES	18 x 13 x 2,5	35,3	7
DXU09519IS	15,7 x 11 x 2,3	34,5	7,6
DXU09521S	19,2 x 14,2 x 2,5	35,5	6,5
DXU09526ES	19,9 x 13 x 3,4	43	9
DXU09526IS	18,9 x 13 x 2,9	39,3	8
DXU09527ES	23 x 17 x 3	34,5	6
DXU09527IS	25 x 18,5 x 3,3	35	6
DXU09528ES	21 x 14,5 x 3,2	36	7
DXU09528IS	21 x 14,4 x 3,3	37,5	7
DXU09529IS	20,2 x 14,2 x 3	39,3	8
DXU09532ES	19,88 x 13 x 3,3	47,5	9

Referencia	Exterior x Interior x Grosor	Altura	nº Espirales
DXU09532IS	18,8 x 13 x 2,9	42,7	9
DXU09533ES	23,68 x 16,5 x 3,6	43	8
DXU09533IS	23,3 x 16,5 x 3,3	41	7
DXU09536ES	23 x 17 x 3	35	6
DXU09536IS	24,95 x 18,6 x 3,2	36,5	6
DXU09537ES	18,3 x 13,6 x 2,3 24,9 x 18,5 x 3,3	40 43,5	8 6
DXU09539IS	23,1 x 16,1 x 3,5	35,5	6,5
DXU09540IS	22,72 x 16,2 x 3,2	37,16	7
DXU09541ES	19 x 13,4 x 2,8	36	7,3
DXU09541IS	21,9 x 15,3 x 3,3	40,9	7,5
DXU09545ES	19 x 12,6 x 3,3	44,5	9,25
DXU09545IS	18,6 x 12,6 x 3	38,5	8,5
DXU09550ES	21,8/25,6 x 14,7/18,4 x 3,6	40	6
DXU09550IS	21,8/25,6 x 14,7/18,4 x 3,6	40	6
DXU09551ES	23,2 x 17 x 3,1	35,5	5
DXU09551IS	20,9 x 14,1 x 3,3	40,8	7
DXU09552IS	22,4 x 16,05 x 3,2	37	7
DXU09553ES	18,6 x 12,9 x 2,8	32,8	7,6
DXU09553IS	20 x 14 x 3	36,8	7,5



Caja de pastillas de reglaje

Referencia	Descripción	P.V.P
DMX0943100	Diámetro 7,48mm - Grosor de 120 a 350 - 141 unidades	145,95
DMX0943300	Diámetro 8,90mm - Grosor de 172 a 260 - 69 unidades	87,95
DMX0943200	Diámetro 9,48mm - Grosor de 120 a 350 - 141 unidades	155,95



Pastillas de reglaje (bolsa con 3 unidades)

Set de 3 unidades
Pastilla de 7,48mm

P.V.P
10,95



Set de 3 unidades
Pastilla de 9,48mm

P.V.P
10,95



Referencia	Medida
DMX0943101	120
DMX0943102	125
DMX0943103	130
DMX0943104	135
DMX0943105	140
DMX0943106	145
DMX0943107	150
DMX0943108	155
DMX0943109	160
DMX0943110	165
DMX0943111	170
DMX0943112	175
DMX0943113	180
DMX0943114	185
DMX0943115	190
DMX0943116	195
DMX0943117	200
DMX0943118	205
DMX0943119	210
DMX0943120	215
DMX0943121	220
DMX0943122	225
DMX0943123	230
DMX0943124	235

Referencia	Medida
DMX0943125	240
DMX0943126	245
DMX0943127	250
DMX0943128	255
DMX0943129	260
DMX0943130	265
DMX0943131	270
DMX0943132	275
DMX0943133	280
DMX0943134	285
DMX0943135	290
DMX0943136	295
DMX0943137	300
DMX0943138	305
DMX0943139	310
DMX0943140	315
DMX0943141	320
DMX0943142	325
DMX0943143	330
DMX0943144	335
DMX0943145	340
DMX0943146	345
DMX0943147	350

Referencia	Medida
DMX0943201	120
DMX0943202	125
DMX0943203	130
DMX0943204	135
DMX0943205	140
DMX0943206	145
DMX0943207	150
DMX0943208	155
DMX0943209	160
DMX0943210	165
DMX0943211	170
DMX0943212	175
DMX0943213	180
DMX0943214	185
DMX0943215	190
DMX0943216	195
DMX0943217	200
DMX0943218	205
DMX0943219	210
DMX0943220	215
DMX0943221	220
DMX0943222	225
DMX0943223	230
DMX0943224	235

Referencia	Medida
DMX0943225	240
DMX0943226	245
DMX0943227	250
DMX0943228	255
DMX0943229	260
DMX0943230	265
DMX0943231	270
DMX0943232	275
DMX0943233	280
DMX0943234	285
DMX0943235	290
DMX0943236	295
DMX0943237	300
DMX0943238	305
DMX0943239	310
DMX0943240	315
DMX0943241	320
DMX0943242	325
DMX0943243	330
DMX0943244	335
DMX0943245	340
DMX0943246	345
DMX0943247	350

Set de 3 unidades
Pastilla de 8,90mm

P.V.P
10,95

Referencia	Medida
DMX0943301	172
DMX0943302	176
DMX0943303	180
DMX0943304	184
DMX0943305	188
DMX0943306	192
DMX0943307	196
DMX0943308	200

Referencia	Medida
DMX0943309	204
DMX0943310	208
DMX0943311	212
DMX0943312	216
DMX0943313	220
DMX0943314	224
DMX0943315	228
DMX0943316	232

Referencia	Medida
DMX0943317	236
DMX0943318	240
DMX0943319	244
DMX0943320	248
DMX0943321	252
DMX0943322	256
DMX0943323	260



Bielas completas

Bielas completas con bulón de cigüeñal, separadores y rodamientos.

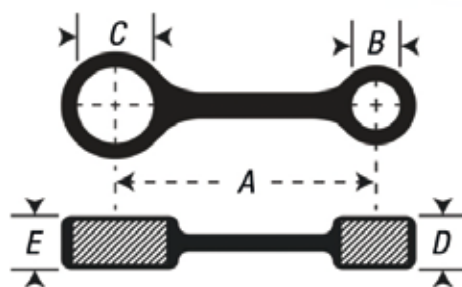

BIELA				BULÓN		RODAMIENTO PISTÓN		RODAMIENTO BIELA				
HONDA	Año	Referencia	P.V.P	A	B	C	D	E	Ø	Largo	Medidas	Medidas
CR 80	86-02	DMX09000	61,01	97	18	26	14,2	14,2	20	45	14x18x.15.8	20x26x13.8
CR 85	03-07	DMX09000	61,01	97	18	26	14,2	14,2	20	45	14x18x.15.8	20x26x13.8
CR 125	88-07	DMX09003	81,39	104	19	29	16	16	22	54	15x19x16.8	22x29x15.8
CRF 150 R	07-14	DMX09046	88,39	75,5	14	32	14	16	25	50	25x32x16	
CRF 150 RB	07-14	DMX09046	88,39	75,5	14	32	14	16	25	50	25x32x16	
CRF 230 F	03-12	DMX09012	64,43	110	18	38	15	18	30	54		
CR 250	84-01	DMX09004	86,45	125,4	22	31	20	16,7	24	60	18x22x22.8	24x31x17
CR 250	02-07	DMX09009	88,68	125,3	22	32	20	16,5	25	59,5	18x22x22.8	25x32x16.5
CRF 250 R	04-14	DMX09138B	101,78	90	16	38	15	18	30	53	16x18x15	30x38x17.8
CRF 250 X	04-13	DMX09138B	101,78	90	16	38	15	18	30	53	16x18x15	30x38x17.8
XR 250	86-05	DMX09006	103,56	105	17	41	18	18	32	58		
CRF 450 R	02-08	DMX09011	128,56	105,5	19	42	18/13	20	34	61	34x42x19.8	34x42x19.8
CRF 450 R	09-14	DMX09088	143,29	102	19	41	18/15.2	19,8	33	60,8	33x41x19.8	
CRF 450 X	05-12	DAT09193	131,24	105.5	19	42	18/13	20	34	65	34x42x19.8	
CR 500	87-01	DMX09007	95,98	144	25	34	24	20	26	68	20x25x27.8	26x35x19.7
XR 600	85-02	DMX09005	139,28	134	24	48	23	23	38	65	38x48x22.8	38x48x22.8
XL 600	83-87	DMX09005	139,28	134	24	48	23	23	38	65	38x48x22.8	38x48x22.8
BIELA				BULÓN		RODAMIENTO PISTÓN		RODAMIENTO BIELA				
HUSABERG	Año	Referencia	P.V.P	A	B	C	D	E	Ø	Largo	Medidas	Medidas
TE 125	12-14	DMX09059	103,12	110	19	28	16	16	22	55		
BIELA				BULÓN		RODAMIENTO PISTÓN		RODAMIENTO BIELA				
HUSQVARNA	Año	Referencia	P.V.P	A	B	C	D	E	Ø	Largo	Medidas	Medidas
CR 125	97-13	DMX09065	88,83	105	19	24	16	30	24	55,3		24x30x15.7
WR 125	97-13	DMX09065	88,83	105	19	24	16	30	24	55,3		24x30x15.7
TC 125	2014	DMX09059	103,12	110	19	28	16	16	22	55		
TE 125	2014	DMX09059	103,12	110	19	28	16	16	22	55		
CR 150	2011	DMX09065	88,83	105	19	24	16	30	24	55,3		24x30x15.7
TC 610	91-98	DMX09103	205,20	127	24	38	22	18	30	60		30x38x17.8
TE 610	91-98	DMX09103	205,20	127	24	38	22	18	30	60		30x38x17.8
BIELA				BULÓN		RODAMIENTO PISTÓN		RODAMIENTO BIELA				
KAWASAKI	Año	Referencia	P.V.P	A	B	C	D	E	Ø	Largo	Medidas	Medidas
KX 60	83-03	DMX09026	68,75	85	16	27	14	14	20	46	12x16x15	20x27x13.8
KX 65	00-14	DMX09026	68,75	85	16	27	14	14	20	46	12x16x15	20x27x13.8
KDX 80	82-88	DMX09027	68,75	92	18	29	16	14	22	46	14x18x17.2	22x29x13.8
KX 80	82-97	DMX09027	68,75	92	18	29	16	14	22	46	14x18x17.2	22x29x13.8
KX 80	98-00	DMX09028	68,75	92	18	29	16	16	22	46	14x18x17.2	22x29x15.8
KX 85	01-14	DMX09028	68,75	92	18	29	16	16	22	46	14x18x17.2	22x29x15.8
KX 100	95-97	DMX09027	68,75	92	18	29	16	14	22	46	14x18x17.2	22x29x13.8
KX 100	98-14	DMX09028	68,75	92	18	29	16	16	22	46	14x18x17.2	22x29x15.8
KX 125	79-87	DMX09029	81,39	106	21	29	17	17,2	22	51	16x21x19.8	22x29x16.8
KX 125	88-91	DMX09031	88,68	109	21	29	17	17	22	51	16x21x19.8	22x29x16.8
KX 125	92-93	DMX09029	81,39	106	21	29	17	17,2	22	51	16x21x19.8	22x29x16.8
KX 125	94-97	DMX09030	86,90	106	19	29	17	17	22	51	15x19x19.8	22x29x16.8
KX 125	98-02	DMX09032	75,59	104	19	29	17	17	22	51	15x19x19.8	22x29x16.8
KX 125	03-06	DMX09035	69,04	104	19	29	17	17	22	56	15x19x19.8	22x29x16.8
KDX 200	86-88	DMX09029	81,39	106	21	29	17	17	22	51	16x21x19.5	22x29x16.8
KDX 200	89-06	DMX09031	88,68	109	21	29	17	17	22	51	16x21x19.8	22x29x16.8
KDX 220	97-06	DMX09031	88,68	109	21	29	17	17	22	51	16x21x19.8	22x29x16.8
KX 250	78-06	DMX09033	82,14	125	22	32	22	19,9	24	59	18x22x23.8	24x32x19.8
KX 250 F	04-09	DMX09050	102,23	92,5	16	38	15	18	30	55		30x38x18
KX 250 F	10-15	DMX09017	89,15	92,5	16	38	15	19	30	56		30x38x18.8
KLX 400	03-04	DAT09165*	105,96	107	20	43	20	22	35	61,85		
KLX 450 R	08-13	DMX09102	124,84	101	19	42	18	19,97	34	60		34x42x19.65
KX 450 F	07-08	DMX09102	124,84	101	19	42	18	19,97	34	60		34x42x19.65
KX 450 F	09-14	DMX09060	161,00	101	19	42	18	19	34	62		
KX 500	85-04	DMX09034	96,12	145	24	33	22	22	26	54	19x24x24.8	26x33x21.9

BIELA				BULÓN		RODAMIENTO PISTÓN		RODAMIENTO BIELA				
KTM	Año	Referencia	P.V.P	A	B	C	D	E	Ø Largo	Medidas	Medidas	
65	97-02	DMX09041	79,46	88	15	24	12,9	14,9	18	56	12x15x16.3	18x24x14.8
65	03-08	DMX09039	72,02	88	15	24	12,9	14,9	18	42	12x15x16.3	18x24x14.8
85 SX	03-12	DMX09040	95,68	96	18	28	13	16	22	46	14x18x15.8	22x28x15.8
85 SX	13-14	DMX09105	100,59	96	18	26	14	15	20	46	14x18x16.5	20x26x14.8
105 SX	03-11	DMX09040	95,68	96	18	28	13	16	22	46	14x18x16.5	22x28x15.8
125 EXC	09-14	DMX09059	103,12	110	19	28	16	16	22	55		
125 SX	98-14	DMX09059	103,12	110	19	28	16	16	22	55		
144 SX	07-08	DMX09059	103,12	110	19	28	16	16	22	55		
150 SX	09-14	DMX09059	103,12	110	19	28	16	16	22	55		
150 XC	10-14	DMX09059	103,12	110	19	28	16	16	22	55		
250	90-99	DMX09099	104,61	132	22	30	16,9	16,9	24	60	18x22x19.8	24x30x16.8
250 EXC-F	06-07	DMX09038	105,20	98	16	38	17,85	17,85	30	53,5		30x38x17.8
250 SX-F	05-12	DMX09038	105,20	98	16	38	17,85	17,85	30	53,5		30x38x17.8
250 SXS-F	07-08	DMX09038	105,20	98	16	38	17,85	17,85	30	53,5		30x38x17.8
250 XC-F	07-09	DMX09038	105,20	98	16	38	17,85	17,85	30	53,5		30x38x17.8
250 XCF-W	08-13	DMX09038	105,20	98	16	38	17,85	17,85	30	53,5		30x38x17.8
250 EXC	04-11	DMX09047	144,48	125	22	30	17	17	24	60	18x22x19.8	24x30x16.8
250 SX	03-14	DMX09047	144,48	125	22	30	17	17	24	60	18x22x19.8	24x30x16.8
250 SXS	03-07	DMX09047	144,48	125	22	30	17	17	24	60	18x22x19.8	24x30x16.8
250 XC	04-14	DMX09047	144,48	125	22	30	17	17	24	60	18x22x19.8	24x30x16.8
250 XC-W	04-14	DMX09047	144,48	125	22	30	17	17	24	60	18x22x19.8	24x30x16.8
300	90-03	DMX09099	104,61	132	22	30	16,9	16,9	24	60	18x22x19.8	24x30x16.8
300 EXC	04-11	DMX09047	144,48	125	22	30	17	17	24	60	18x22x19.8	24x30x16.8
300 MXC	04-11	DMX09047	144,48	125	22	30	17	17	24	60	18x22x19.8	24x30x16.8
300 XC	04-14	DMX09047	144,48	125	22	30	17	17	24	60	18x22x19.8	24x30x16.8
300 XC-W	04-14	DMX09047	144,48	125	22	30	17	17	24	60	18x22x19.8	24x30x16.8
LC4 400	97-07	DMX09015	179,01	141,5	22	50	22,9	22,9	40	65	40x40x22.7	
LC4 600	97-07	DMX09015	179,01	141,5	22	50	22,9	22,9	40	65	40x40x22.7	

BIELA				BULÓN		RODAMIENTO PISTÓN		RODAMIENTO BIELA				
SUZUKI	Año	Referencia	P.V.P	A	B	C	D	E	Ø Largo	Medidas	Medidas	
RM 60	2003	DMX09026	68,75	85	16	27	14	14	20	46	12x16x15	20x27x13.8
RM 65	03-05	DMX09026	68,75	85	16	27	14	14	20	46	12x16x15	20x27x13.8
RM 85	02-12	DMX09055	68,75	93,5	18	26	14	14	20	45	14x18x15.8	20x26x13.8
RM 100	03-05	DMX09028	68,75	92	18	29	16	16	22	46	14x18x17.2	22x29x15.8
RM 125	88-96	DMX09052	81,39	105	19	28	18	16	22	53	15x19x19.8	22x28x15.8
RM 125	99-03	DMX09057	85,41	102	19	28	18	16	22	53	15x19x19.8	22x28x15.8
RM 125	04-09	DMX090591	82,46	110	19	28	16	16	22	52,7	15x19x19.8	22x28x15.8
RM 250	87-95	DMX09053	83,48	128	23	30	20	20	24	58	18x23x22	24x30x19.8
RM 250	96-02	DMX09054	99,55	125,5	23	30	20	20	24	58	18x23x22	24x30x19.8
RM 250	03-08	DMX09058	99,55	125	23	32	20	20	24	58	18x23x22	24x30x19.8
RMX 250	93-99	DMX09053	83,48	128	23	30	20	20	24	58	18x23x22	24x30x19.8
RMZ 250	04-06	DMX09050	102,23	92,5	16	38	15	18	30	55		30x38x18
DRZ 400	00-14	DAT09165	105,96	107	20	43	20	22	35	61,85		
DRZ 400 SM	00-14	DAT09165	105,96	107	20	43	20	22	35	61,85		
RMZ 450	05-07	DMX09016	119,39	106	19	42	18.5	20	34	61		34x42x19.8
RMZ 450	13-15	DMX09016	119,39	106	19	42	18.5	20	34	61		34x42x19.8

BIELA				BULÓN		RODAMIENTO PISTÓN		RODAMIENTO BIELA				
YAMAHA	Año	Referencia	P.V.P	A	B	C	D	E	Ø Largo	Medidas	Medidas	
YZ 80	93-01	DMX09076	61,31	96	18	26	14	14	20	44	14x18x15.8	20x26x13.8
YZ 85	02-14	DMX09076	61,31	96	18	26	14	14	20	44	14x18x15.8	20x26x13.8
YZ 125	86-96	DMX09077	77,24	105	20	29	17	17	22	55	16x20x19.5	22x29x16.8
YZ 125	97-00	DMX09078	78,75	105	20	29	17	17	22	55	15x20x17.7	22x29x16.8
YZ 125	01-04	DMX09082	85,65	105	19	29	16	17	22	55	15x19x16.8	22x29x16.8
YZ 125	05-14	DMX09084	73,51	102	19	29	16	17	22	54	15x19x17	22x29x16
DT 125		DMX09109	44,49	105	20	28	18	16	22	54	16x20x20	22x28x16
DT 125 LC		DMX09109	44,49	105	20	28	18	16	22	54	16x20x20	22x28x16
TRZ 150 R		DMX09014	63,09	105	21	29	18	17	22	56,5	16x21x19.5	22x29x16.8
DT 175		DMX09109	44,49	105	20	28	18	16	22	54	16x20x20	22x28x16
YZ 250	90-98	DMX09080	92,85	125	23	32	20	20	25	60	18x23x22	25x32x19.8
YZ 250	99-14	DMX09083	81,54	125	22	31	20	17	24	59	18x23x22	24x31x16.8
WR 250	90-98	DMX09080	92,85	125	23	32	20	20	25	60	18x23x22	25x32x19.8
YZ 250 F	03-13	DMX09085	122,16	93,5	16	40	15	18	32	55		32x40x20
WR 250 F	03-13	DMX09085	122,16	93,5	16	40	15	18	32	55		32x40x20
YZ 400	1998	DMX09081	120,30	102	18	42	18	20	34	60,8		34x42x19.8
YZ 450 F	03-05	DMX09086	109,22	103,5	18	42	18	20	34	61		34x42x20
YZ 450 F	06-09	DMX09087	107,73	103,5	18	42	18	20	34	61		34x42x20
YZ 450 F	10-13	DMX09090	128,71	103	18	42	18	21	34	61		34x22x20.8
WR 450 F	04-05	DMX09086	109,22	103,5	18	42	18	20	34	61		34x42x20
WR 450 F	07-11	DMX09087	107,73	103,5	18	42	18	20	34	61		34x42x20
XT 500		DMX09044	169,48	145	20	42	24	24	34	73,8		35x43x21.8
XT 600 E		DMX09043	162,79	135,5	22	43	22	22	35	74		34x42x23.5

RUEDAS Y NEUMÁTICOS

MOTOR

ADMISIÓN / ESCAPE
REFRIGERACIÓN

ELÉCTRICO

SUSPENSIÓN / DIRECCIÓN

FRENOS

TRANSMISIÓN

CONTROLES Y MANDOS

CHASIS

ACCESORIOS



Cigüeñales completos

Cigüeñal y biela montado, listo para ser sustituido. Incluye el rodamiento de biela-pistón.

HONDA	Año	Referencia	P.V.P
CR 80 R	86-02	DMX09115	152,35
CR 85 R	03-04	DMX09115	152,35
CRF 250 R	04-09	DMX09138	211,78
CRF 250 R	10-14	DMX09135	216,45

KAWASAKI	Año	Referencia	P.V.P
KX 80	91-00	DMX09119	152,35
KX 85	01-05	DMX09119	152,35
KX 100	95-05	DMX09119	152,35
KX 125	03-05	DMX09118	165,64

KTM	Año	Referencia	P.V.P
85 SX	03-12	DMX09137	148,65
105 SX	04-11	DMX09137	148,65
250 XCF-W	12-13	DMX09136	195,30
250 SX-F	05-10	DMX09139	182,28
250 SX-F	11-12	DMX09136	195,30
250 XC-F	11-12	DMX09136	195,30

SUZUKI	Año	Referencia	P.V.P
RM 100	2003	DMX09119	152,35
RM 125	04-07	DMX09131	190,00

YAMAHA	Año	Referencia	P.V.P
YZ 125	05-14	DMX09133	181,24
YZ 250	03-14	DMX09140	

Extractor de rodamientos

Referencia	P.V.P.
DMC12729	112,85



- 8-10 mm
- 10-12 mm
- 12-14 mm
- 15-17 mm
- 17-20 mm
- 20-24 mm
- 25-29 mm
- 30-32 mm

Extractor de retenes

Referencia	P.V.P.
DUP121791	14,98



PSYCHIC Kit retenes motor

El kit consta de todo el material necesario para sustituir los retenes del motor.

HONDA	Año	Referencia	P.V.P
CR 125	05-07	DMX09277	14,73
CRF 150 R	07-14	DMX09272	19,25
CR 250 R	02-04	DMX09261	11,29
CRF 250 R	10-14	DMX09273	24,12
CRF 250 X	04-12	DMX09279	20,91
CRF 450 R	07-08	DMX09284	21,15
CRF 450 R	09-14	DMX09285	21,62
CRF 450 X	05-08	DMX09274	21,38

KAWASAKI	Año	Referencia	P.V.P
KX 250	05-08	DMX09289	14,02
KX 250 F	06-13	DMX09378	12,71
KX 450 F	06-13	DMX09379	12,47

KTM	Año	Referencia	P.V.P
65 SX	09-14	DMX09290	18,65
65 XC	09-14	DMX09290	18,65
85 SX	03-13	DMX09294	13,90
85 XC	03-13	DMX09294	13,90
105 SX	03-13	DMX09294	13,90
105 XC	03-13	DMX09294	13,90
250 SX	03-12	DMX09295	16,51
250 XC	06-12	DMX09295	16,51
250 XC-W	06-12	DMX09295	16,51
250 SX-F	05-06	DMX09296	16,75
250 XC-F	05-06	DMX09296	16,75

250 XC-W	05-11	DMX09296	16,75
250 SXS-F	05-11	DMX09296	16,75
350 SX-F	11-12	DMX09291	29,34
350 XC-F	11-12	DMX09291	29,34
400 SX	00-02	DMX09292	14,02
400 MXC	00-02	DMX09292	14,02
400 EXC	00-02	DMX09292	14,02
400 SX	00-02	DMX09292	14,02
400 EXC	04-06	DMX09292	14,02
450 EXC	03-07	DMX09292	14,02
450 MXC	03-05	DMX09292	14,02
450 SX	03-06	DMX09292	14,02
450 SXS-F	07-12	DMX09293	30,29
450 SX-F	07-12	DMX09293	30,29
450 XC-F	08-09	DMX09293	30,29
500 SX	08-09	DMX09293	30,29
500 SX-F	08-09	DMX09293	30,29
500 XC-F	08-09	DMX09293	30,29
505 SX	08-09	DMX09293	30,29
505 SX-F	08-09	DMX09293	30,29
505 XC-F	08-09	DMX09293	30,29
520 SX	00-02	DMX09292	14,02
520 MXC	00-02	DMX09292	14,02
520 EXC	00-02	DMX09292	14,02
525 SX	03-07	DMX09292	14,02
525 MXC	03-07	DMX09292	14,02
525 EXC	03-07	DMX09292	14,02



SUZUKI	Año	Referencia	P.V.P
RM 125	01-03	DMX09269	17,34
RM 250	03-05	DMX09265	16,75
RMZ 250	04-06	DMX09372	12,47
RMZ 250	07-08	DMX09363	18,65
RMZ 250	10-12	DMX09364	20,08
RMZ 450	05-07	DMX09366	19,96
RMZ 450	08-13	DMX09365	21,86

YAMAHA	Año	Referencia	P.V.P
YZ 125	05-14	DMX09271	14,85
WR 250 F	01-09	DMX09267	10,81
YZ 250	99-08	DMX09220	19,48
YZ 250 F	01-13	DMX09267	10,81
WR 450 F	03-09	DMX09298	10,81
YZ 450 F	03-13	DMX09298	10,81

Extractor de bulón

Referencia	P.V.P.
X09610	16,68



Compresor de válvulas

Referencia	P.V.P.
DUP121911	35,10



Montador de válvulas

Referencia	Descripción	P.V.P.
DMX12971	Válvula 5mm	13,14
DMX129711	Válvula 5,5mm	13,14



Útil zapatas embrague KTM

Referencia	P.V.P.
DMX12154	9,00



Ajustador válvula escape 2t KTM

Referencia	P.V.P.
DMX12153	9,80



Alicates plato embrague

Referencia	P.V.P.
DUP12212	17,95





Kit discos embrague



El Kit de Embrague reforzado consta de los discos de fricción más los discos metálicos o de separación y los muelles. La calidad es superior a los discos originales, en algunos casos puede ser como mínimo igual al original.

HONDA	Año	Referencia	P.V.P
CR 80 R	87-02	DMX03500H	27,32
CR 80 RB	87-02	DMX03500H	27,32
CR 85 R	03-07	DMX03500H	27,32
CRF 100 F	04-14	DMX03576H	23,09
XR 100 R	87-03	DMX03576H	23,09
CR 125 R	86-99	DMX03501H	46,30
CR 125 R	00-07	DMX03547H	52,11
CRF 150 R	07-13	DMX03205H	37,60
CRF 150 RB	07-13	DMX03205H	37,60
XR 200 R	86-02	DMX03578H	27,57
CRF 230 F	03-14	DMX03580H	38,08
CR 250 R	83-89	DMX03502H	53,68
CR 250 R	90-93	DMX03543H	60,45
CR 250 R	94-07	DMX03552H	64,98
CRF 250 L	13-14	DMX03704H	38,93
CRF 250 R	04-07	DMX03602H	51,02
CRF 250 R	08-09	DMX03231H	52,71
CRF 250 R	11-13	DMX03631H	58,23
CRF 250 RA	2010	DMX03610H	47,13
CRF 250 RB	11-13	DMX03231H	52,71
CRF 250 X	04-13	DMX03231H	52,71
CRF 250 L	13-14	DMX03704H	38,93
XR 250 R	86-95	DAT03903	37,07
XR 250 R	96-04	DMX03583H	38,45
XR 250 L	91-96	DAT03903	37,07
XR 400 R	1996	DMX03584H	46,79
XR 400 R	97-04	DMX03585H	44,49
CRF 450 R	02-03	DMX03551H	64,87
CRF 450 R (6 muelles)	04-05	DMX03574H	66,44
CRF 450 R (6 muelles)	06-08	DMX03551H	62,02
CRF 450 R (4 muelles)	09-10	DMX03611H	60,81
CRF 450 R	11-12	DMX03632H	60,57
CRF 450 R	2013	DMX03664H	63,11
CRF 450 R	2014	DMX03672H	64,68
CRF 450 RA (4 muelles)	09-10	DMX03611H	60,81
CRF 450 RB	2011	DMX03632H	60,57
CRF 450 X	05-14	DMX03574H	61,30
CR 500 R	84-89	DMX03502H	53,68
CR 500 R	90-02	DMX03543H	60,45
XR 600 R	85-00	DMX03588H	51,14
NX 650	88-89	DMX03588H	51,14
XR 650 L	93-14	DMX03588H	51,14

KAWASAKI	Año	Referencia	P.V.P
KX 60	85-03	DMX03503H	25,87
KX 65	00-14	DMX03546H	26,24
KX 80	89-97	DMX03506H	34,70
KX 80	98-00	DMX03528H	35,91
KX 85	01-14	DMX03528H	35,91
KX 100	95-97	DMX03506H	34,70
KX 100	98-14	DMX03528H	35,91
KX 125	94-02	DMX03541H	49,57
KX 125	03-05	DMX03564H	53,32
KLX 250 S	06-14	DMX03614H	48,24
KX 250	92-07	DMX03529H	63,59
KX 250 F	04-14	DMX03601H	60,88
KLX 300 R	98-07	DMX03614H	48,24
KLX 400 R	03-04	DAT03915H	61,63
KLX 450 R	08-12	DMX03200H	60,69
KX 450 F	06-11	DMX03200H	60,69
KX 450 F	12-14	DMX03634H	63,11

KTM	Año	Referencia	P.V.P
60 SX	98-00	DMX03549H	33,49
65 SX	98-08	DMX03549H	33,49
65 SX	09-14	DMX03233H	33,49
65 XC	2008	DMX03549H	33,49
65 XC	09-10	DMX03233H	33,49
85 SX (17"/14")	03-14	DMX03210H	37,00

85 SX (19"/16")	03-14	DMX03210H	37,00
85 XC	08-09	DMX03210H	37,00
105 SX	04-10	DMX03210H	37,00
105 XC	08-10	DMX03210H	37,00
125 EGS	98-99	DMX03605H	48,99
125 EXC	98-05	DMX03605H	48,99
125 EXE	00-01	DMX03605H	48,99
125 Supermoto	00-01	DMX03605H	48,99
125 SX	98-07	DMX03605H	48,99
125 SX	2008	DMX03234H	49,33
125 SX	09-14	DMX03605H	48,99
125 SXS	01-02	DMX03605H	48,99
150 SX	08-14	DMX03230H	48,72
150 XC	10-14	DMX03230H	48,72
200 EGS	98-99	DMX03230H	48,72
200 EXC	97-05	DMX03230H	48,72
200 MXC	98-03	DMX03230H	48,72
200 SX	2003	DMX03230H	48,72
200 XC-W	07-14	DMX03230H	48,72
200 XC	06-09	DMX03230H	48,72
250 SX	94-11	DMX03550H	70,73
250 EGS	94-99	DMX03550H	70,73
250 EXC	94-05	DMX03550H	70,73
250 EXC Racing	02-03	DMX03208H	94,30
250 EXC Racing	2004	DMX03235H	76,89
250 EXC Racing	2005	DMX03239H	93,21
250 EXG-G Racing	2003	DMX03208H	94,30
250 EXC-G Racing	2004	DMX03235H	76,89
250 MXC	98-99	DMX03550H	70,73
250 SX	94-12	DMX03550H	70,73
250 SX-F	05-12	DMX03207H	51,14
250 SX-F	13-14	DMX03630H	109,54
250 XC-F	06-09	DMX03207H	51,14
250 XC-F	13-14	DMX03630H	109,54
250 XC-F-W	06-13	DMX03207H	51,14
250 XC-F-W	2014	DMX03705H1	103,63
250 XC-W	06-12	DMX03550H	70,73
250 XC-W	13-14	DMX03706H1	103,63
250 XC-F-W Six Days	2011	DMX03207H	51,14
250 XC	06-12	DMX03550H	70,73
250 XC	13-14	DMX03706H1	103,63
250 SXS	01-03	DMX03550H	70,73
300 E-GS	94-99	DMX03550H	70,73
300 EXC	94-05	DMX03550H	70,73
300 MXC	94-05	DMX03550H	70,73
300 SX	1994	DMX03550H	70,73
300 Six Days	1996	DMX03550H	70,73
300 XC	06-12	DMX03550H	70,73
300 XC	13-14	DMX03706H	70,73
300 XC-W	06-11	DMX03550H	70,73
350 EXC-F	12-14	DMX03705H	46,30
350 SX-F	11-13	DMX03630H	109,54
350 XC-F	11-14	DMX03630H	109,54
350 XC-F-W	12-14	DMX03705H1	103,63
360 EGS	96-97	DMX03550H	70,73
360 EXC	96-97	DMX03550H	70,73
360 MXC	96-97	DMX03550H	70,73
360 SX	96-97	DMX03550H	70,73
360 Six Days	1996	DMX03550H	70,73
380 EXC	98-02	DMX03550H	70,73
380 MXC	98-01	DMX03550H	70,73
380 SX	98-02	DMX03550H	70,73
400 EXC	00-01	DMX03235H	76,89
400 EXC	2007	DMX03208H	94,30
400 EXC	2002	DMX03208H	94,30
400 EXC Racing	2005	DMX03239H	93,21
400 EXC-G Racing	2002	DMX03208H	94,30
400 EXC-G Racing	2005	DMX03239H	93,21
400 EXC-G Racing	2006	DMX03208H	94,30
400 MXC	2001	DMX03235H	76,89

400 MXC	2002	DMX03208H	94,30
400 RXC-E	1995	DMX03550H	70,73
400 SX	00-01	DMX03235H	76,89
400 SX Racing	2002	DMX03208H	94,30
400 XC-W	10-11	DMX03628H	75,44
450 EXC	06-07	DMX03208H	94,30
450 EXC Racing	10-11	DMX03628H	75,44
450 EXC Racing	2003	DMX03208H	94,30
450 EXC-G Racing	2003	DMX03208H	94,30
450 EXC Racing	2004	DMX03235H	76,89
450 EXC Racing	2005	DMX03239H	93,21
450 EXC-G Racing	2004	DMX03235H	76,89
450 LXC-G Racing	2005	DMX03239H	93,21
450 MXC	2006	DMX03208H	94,30
450 MXC-G Racing	2003	DMX03208H	94,30
450 MXC-G Racing	2004	DMX03235H	76,89
450 MXC-G Racing	2005	DMX03239H	93,21
450 SMR	04-05	DMX03208H	94,30
450 SMR	2006	DMX03208H	94,30
450 SX	2006	DMX03208H	94,30
450 SX-F	07-10	DMX03209H	73,14
450 SX-F	2012	DMX03705H1	103,63
450 SX-F	2013	DMX03706H1	103,63
450 SX-F	14-15	DMX03709H1	103,63
450 SX Racing	2003	DMX03208H	94,30
450 SX Racing	2004	DMX03235H	76,89
450 SX Racing	2005	DMX03239H	93,21
450 EXC-R	2008	DMX03628H	75,44
450 XCR-W	2008	DMX03628H	75,44
450 XC-W	08-09	DMX03209H	73,14
450 XC-W Six Days	10-11	DMX03628H	75,44
450 XC-W	2012	DMX03705H	46,30
450 XC-W	2014	DMX03709H1	103,63
450 XC-F	08-09	DMX03209H	73,14
450 XC-F	2013	DMX03706H1	103,63
450 XC-F	14-15	DMX03709H1	103,63
450 XC-W	2012	DMX03705H1	103,63
500 EXC	2012	DMX03705H1	103,63
500 XC-W	13-14	DMX03706H1	103,63
505 SX-F	07-08	DMX03209H	73,14
505 XC-F	08-09	DMX03209H	73,14
520 EXC	00-01	DMX03235H	76,89
520 SX Racing	00-01	DMX03235H	76,89
520 SX Racing	2002	DMX03208H	94,30
525 EXC-G Racing	2003	DMX03208H	94,30
525 EXC	2003	DMX03208H	94,30
525 EXC Racing	2004	DMX03235H	76,89
525 EXC Racing	2005	DMX03239H	93,21
525 EXC-G Racing	2004	DMX03235H	76,89
525 EXC-G Racing	2005	DMX03239H	93,21
525 MXC Desert Rac.	2006	DMX03208H	94,30
525 MXC Desert Rac.	2003	DMX03208H	94,30
525 MXC Desert Rac.	2004	DMX03235H	76,89
525 MXC Desert Rac.	2005	DMX03239H	93,21
525 MXC-G Racing	2004	DMX03235H	76,89
525 SMR	04-05	DMX03239H	93,21
525 SX Racing	2006	DMX03208H	94,30
525 SX Racing	2003	DMX03208H	94,30
525 SX Racing	2004	DMX03235H	76,89
525 SX Racing	2005	DMX03239H	93,21
530 EXC	10-11	DMX03628H	75,44
530 EXC Champ. Edi.	2010	DMX03628H	75,44
530 XC-W Six Days	10-11	DMX03628H	75,44
540 SXC	98-99	DMX03625H	71,33
540 SXS Racing	2002	DMX03208H	94,30
560 SMR	2006	DMX03208H	94,30
620 LC4 Competition	1999	DMX03625H	71,33
620 LC4 Super Moto	1999	DMX03625H	71,33
620 Super Comp	96-99	DMX03625H	71,33
620 SX	97-99	DMX03625H	71,33
620 SX	1999	DMX03625H	71,33
620 RXC-E	1995	DMX03550H	70,73
620 SC	00-01	DMX03625H	71,33
620 Supermoto	1998	DMX03625H	71,33
620 TXC	1998	DMX03625H	71,33

625 SMC	04-06	DMX03625H	71,33
625 SC	2002	DMX03625H	71,33
625 SXC	03-04	DMX03625H	71,33
640 Adventure-R	98-02	DMX03625H	71,33
640 LC4	99-00	DMX03625H	71,33
640 LC4-E	00-02	DMX03625H	71,33
640 LC4 Adventure	03-06	DMX03625H	71,33
640 LC4 Supermoto	03-04	DMX03625H	71,33
640 LC4 Six Days	1999	DMX03625H	71,33
660 LC4 Rallye	99-00	DMX03625H	71,33
690 Enduro	2008	DMX03627H	70,85
690 Enduro R	10-14	DMX03627H	70,85
690 Supermoto	07-08	DMX03627H	70,85
690 SMC	08-11	DMX03627H	70,85

SUZUKI

Año	Referencia	P.V.P	
RM 60	2003	DMX03503H	25,87
RM 65	03-05	DMX03546H	26,24
RM 80	91-01	DMX03516H	30,71
RM 85	02-12	DMX03516H	30,71
RM 100	03-04	DMX03546H	26,24
DR-Z 110	03-05	DMX03546H	26,24
RM 125	93-98	DMX03565H	53,32
RM 125	99-01	DMX03572H	55,73
RM 125	02-08	DMX03604H	59,48
RM 250	88-90	DMX03526H	62,51
RM 250	91-93	DMX03530H	64,44
RM 250	94-95	DMX03540H	62,51
RM 250	1996	DMX03553H	66,37
RM 250	97-02	DMX03554H	71,34
RM 250	03-05	DMX03711H	54,28
RM 250	06-08	DMX03237H	74,35
RMX 250	94-00	DMX03540H	62,51
RM-Z 250	04-06	DMX03601H	57,31
RM-Z 250	07-09	DMX03206H	62,14
RM-Z 250	10-14	DMX03620H	59,72
DR 350	90-99	DMX03593H	54,16
DR-Z 400 E	00-14	DAT03915H	65,37
RMX 450	10-11	DMX03575H	70,36
RM-Z 450	05-12	DMX03575H	70,36

YAMAHA

Año	Referencia	P.V.P	
YZ 80	86-92	DMX03517H	31,55
YZ 80	93-94	DMX03534H	31,55
YZ 80	95-01	DMX03555H	37,12
YZ 85	02-14	DMX03573H	38,57
TTR 125	00-14	DMX03619H	26,11
YZ 125	91-92	DMX03525H	46,06
YZ 125	1996	DMX03556H	58,84
YZ 125	97-01	DMX03538H	51,99
YZ 125	02-04	DMX03556H	58,84
YZ 125	05-14	DMX03538H	51,99
WR 200 D	1992	DAT03901H	38,41
WR 250	2001	DMX03568H	55,73
WR 250 F	02-13	DMX03570H	59,85
WR 250 R	08-11	DMX03525H	46,06
WR 250 X	08-11	DMX03525H	46,06
YZ 250	85-87	DMX03523H	51,87
YZ 250	88-92	DMX03521H	57,43
YZ 250	93-99	DMX03539H	64,92
YZ 250	00-01	DMX03544H	64,92
YZ 250	02-14	DMX03567H	65,65
YZ 250 F	01-07	DMX03568H	55,73
YZ 250 F	08-13	DMX03229H	62,12
WR 400 F	98-00	DMX03545H	56,22
YZ 400 F	98-99	DMX03545H	56,22
YZ 426 F	2000	DMX03548H	68,31
YZ 426 F	01-02	DMX03569H	69,15
WR 426 F	01-02	DMX03603H	69,15
WR 450 F	03-04	DMX03603H	69,15
WR 450 F	05-14	DMX03218H	67,82
YZ 450 F	03-04	DMX03557H	69,03
YZ 450 F	05-06	DMX03201H	67,70
YZ 450 F	07-13	DMX03217H	65,89
YZ 490	82-89	DMX03522H	51,14
XT 600	90-95	DAT03904H	

EMGO

PSYCHIC

Filtros de aceite



Tipo	Equivalencia Hifo Filtro	Ref. EMGO	Ref. BRONCO	P.V.P
A	HF112	E10-99200		2,58
A	HF116		DAT07066	3,24
A	HF132/HF972		DAT07001	2,58
A	HF136	E10-99300		2,58
A	HF139	E10-55510		2,58
A	HF140	E10-79130		2,58
A	HF141/HF981	E10-79130		2,58
A	HF142	E10-79120		2,58
A	HF143	E10-79110		2,58
A	HF154		DMX07170	3,47
A	HF155/HF655		DMX07010	3,57
A	HF157		DMX07013	3,64
A	HF-207		DMX07157	3,20
C	HF303	E10-82230		5,52
A	HF563		DMX07171	3,76
A	HF611		DMX07019	3,86
A	HF631		DMX07172	3,41
A	HF652		DMX07011	3,20

APRILIA	Año	Referencia	Hifo filtro
125RS4	11-14	DMX07171	HF-563
450 RXV	06-14	DMX07171	HF-563
450 SXV Street Legal	2009	DMX07171	HF-563
450 SXV Supermoto	06-13	DMX07171	HF-563
550 RXV Enduro	06-13	DMX07171	HF-563
550 SXV Street Legal	2009	DMX07171	HF-563
550 SVX Supermoto	06-13	DMX07171	HF-563

BETA	Año	Referencia	Hifo filtro
250 RR Enduro 4T	05-09	DMX07010	HF-155
		DMX07013	HF-157
250 EVO 4T	09-13	DMX07157	HF-207
250 REV 4T	07-08	DMX07157	HF-207
300 EVO 4T	09-13	DMX07157	HF-207
350 Alp 4,0	03-13	DMC07255	HF-136
350 Euro	01-12	DMC07255	HF-136
350 Jonathan	01-12	DMC07255	HF-136
350 Maat	06-15	DMC07255	HF-136
350 Motard 4,0	03-12	DMC07255	HF-136
350 RR Enduro	11-14	DMX07172	HF-631
400 RR Enduro 4T	05-09	DMX07010	HF-155
		DMX07013	HF-157
400 RR Enduro 4T	10-14	DMX07172	HF-631
450 RR Enduro 4T	05-09	DMX07010	HF-155
		DMX07013	HF-157
450 RR Enduro 4T	10-14	DMX07172	HF-631
498 RR Enduro 4T		DMX07172	HF-631
520 RR Enduro 4T	10-14	DMX07172	HF-631
525 RR Enduro 4T	05-09	DMX07010	HF-155
		DMX07013	HF-157

BMW	Año	Referencia	Hifo filtro
G 450 X	09-12	DMX07019	HF-611

GAS GAS	Año	Referencia	Hifo filtro
EC 250 F 4T	10-11	E10-79130	HF-141
EC 250 F 4T	12-13	E10-79110	HF-140
EC 250 F 4T Six Days	2012	E10-79110	HF-140
400 FSE/SM	03-07	E10-99200	HF-112
450FSE/SM	03-07	E10-99200	HF-112
450 FSR/EC/SM	2008	E10-99200	HF-112
450 Pampera	07-08	E10-99200	HF-112
510 EC/SM	2009	E10-99200	HF-112

HONDA	Año	Referencia	Hifo filtro
CRF 150 R	07-14	DAT07066	HF-116
XR 200 R	84-93	E10-99200	HF-112
CRF 250R	04-13	DAT07066	HF-116
CRF 250 RE	14-15	DAT07066	HF-116
CRF 250 X	04-15	DAT07066	HF-116
XL 250	91-95	E10-99200	HF-112
XLR 250 R	84-92	E10-99200	HF-112
XR 250	95-00	E10-99200	HF-112
XR 250	86-04	E10-99200	HF-112
XR 250 L	91-97	E10-99200	HF-112
XR 250 R	84-06	E10-99200	HF-112
XR 400 R	96-04	E10-99200	HF-112
CRF 450 R	02-15	DAT07066	HF-116
CRF 450 X	05-15	DAT07066	HF-116
XL 600 R	83-88	E10-99200	HF-112
XR 600 R	85-02	E10-99200	HF-112
FMX 650	05-07	E10-99200	HF-112
FX 650 Vigor	99-02	E10-99200	HF-112
NX 650 Dominator	88-02	E10-99200	HF-112
SLR 650 Vigor	97-00	E10-99200	HF-112
XR 650 L	93-14	E10-99200	HF-112
XR 650 R	00-07	E10-99200	HF-112

HUSABERG	Año	Referencia	Hifo filtro
FE 250	2013	DMX07010	HF-655
FE 250	2014	DMX07011	HF-652
FE 350	2013	DMX07011	HF-652
FE 390	10-12	DMX07010	HF-655
FC 450	04-06	DMX07010	HF-155
FE 450	04-08	DMX07010	HF-155
FS 450	04-08	DMX07010	HF-155
FE 450	09-14	DMX07010	HF-655
FX 450 Cross Country	10-11	DMX07010	HF-655
FE 501	13-14	DMX07010	HF-655
FC 550	04-06	DMX07010	HF-155
FE 550	04-08	DMX07010	HF-155
FS 550	04-08	DMX07010	HF-155
FE 570 Enduro	09-12	DMX07010	HF-655
FS 570 Supermoto	10-11	DMX07010	HF-655
FE 650	04-08	DMX07010	HF-155
FS 650	04-08	DMX07010	HF-155

HUSQVARNA	Año	Referencia	Hifo filtro
SMR 125 4T	2012	E10-79110	HF-140
SMS 125 4T	11-13	E10-79110	HF-140
TE 125 4T	11-13	E10-79110	HF-140
SMR 250 R	2007	DMX07170	HF-154
TC 250	02-07	DMX07170	HF-154
TC 250	2008	DMX07171	HF-563
TC 250	09-15	DAT07066	HF-116
TC 250 R	2013	DAT07066	HF-116
TE 250	08-14	DMX07171	HF-563
TE 250 R	02-07	DMX07170	HF-154
TE 250 R	10-14	DAT07066	HF-116
TXC 250	08-09	DMX07171	HF-563
TXC 250	10-14	DAT07066	HF-116
TXC 250 R	2013	DAT07066	HF-116
TE 310	09-10	DMX07171	HF-563
TE 310	11-14	DAT07066	HF-116
TE 310 R	2013	DAT07066	HF-116
TXC 310 R	11-14	DAT07066	HF-116
TE 410 E	98-01	DMX07170	HF-154
SMR 449	11-12	DMX07019	HF-611
TC 449	11-14	DMX07019	HF-611
TE 449	11-14	DMX07019	HF-611
SM 450 R	08-10	DMX07171	HF-563
SM 450 RR	2009	DMX07171	HF-563
TXC 450	08-11	DMX07171	HF-563
SM 450 R	04-07	DMX07170	HF-154
TC 450	02-07	DMX07170	HF-154
TC 450	08-10	DMX07171	HF-563
TE 450	02-07	DMX07170	HF-154
TE 450	08-10	DMX07171	HF-563
SM 510 R	08-10	DMX07171	HF-563
TC 510	05-10	DMX07170	HF-154
TE 510	04-07	DMX07170	HF-154
TC 510	08-10	DMX07171	HF-563
TCX 510	08-11	DMX07171	HF-563
TE 510	06-10	DMX07171	HF-563
TXC 510	08-09	DMX07171	HF-563
SMR 511	11-12	DMX07019	HF-611
TE 511	11-14	DMX07019	HF-611
SM 530 RR	2009	DMX07171	HF-563
SM 610	98-99	DMX07170	HF-154
SM 610 S	00-01	DMX07170	HF-154
SM 610 S IE	06-08	DMX07170	HF-154
TE 610 E Enduro	98-01	DMX07170	HF-154



Filtros de aceite

KTM

** DMX07010 Largo

*DMX07013 Corto



TE 610 E LT	2000	DMX07170	HF-154
TE 610 IE	06-08	DMX07170	HF-154
SM 630 IE	2010	DMX07171	HF-563
SMR 630	2011	DMX07171	HF-563
SMS 630	2011	DMX07171	HF-563
TE 630	2011	DMX07171	HF-563
TE 630 IE	2010	DMX07171	HF-563

KAWASAKI	Año	Referencia	Hifo filtro
KLX 110	02-14	E10-99200	HF-112
KLX 125	03-06	E10-55500	HF-132
KLX 125	10-14	E10-99200	HF-112
KLX 140	08-14	E10-99200	HF-112
KL 250	97-03	E10-99200	HF-112
KLX 250	98-01	E10-99200	HF-112
KLX 250 D Tracker	98-02	E10-99200	HF-112
KLX 250 ES	94-97	E10-99200	HF-112
KLX 250 R	93-96	E10-99200	HF-112
KLX 250 R	06-09	E10-99200	HF-112
KLX 250 S	06-09	E10-99200	HF-112
KLX 250 SR	93-97	E10-99200	HF-112
KXF 250	04-15	DMX07157	HF-207
KLX 300	96-08	E10-99200	HF-112
KLX 300 R	97-06	E10-99200	HF-112
KLX 400 R/S	03-05	E10-55510	HF-139
KLX 450 R	08-14	E10-99200	HF-112
KXF 450	06-15	E10-99200	HF-112
KLR 600 R	84-90	E10-30000	HF-123
KLE 650	08-14	E10-82230	HF-303
KLR 650	87-14	E10-30000	HF-123
KLX 650 R	93-01	E10-30000	HF-123

KTM	Año	Referencia	Hifo filtro
250 EXC Racing	03-06	DMX07010**	HF-155
		DMX07013*	HF-157
250 EXC-F	07-12	DMX07010	HF-655
250 EXC-F	2013	DMX07011	HF-652
250 SX-F	06-12	DMX07010	HF-655
250 SX-F	13-14	DMX07011	HF-652
350 EXC-F	12-14	DMX07011	HF-652
350 Freeraid	12-14	DMX07011	HF-652
350 SX-F	11-14	DMX07011	HF-652
350 XCF-F	12-14	DMX07011	HF-652
350 XCF-FW	12-14	DMX07011	HF-652
390 Duke	13-14	DMX07010	HF-155
		DMX07010**	HF-155
400 EGS	94-97	DMX07013*	HF-157
		DMX07010**	HF-155
400 EXC	04-05	DMX07013*	HF-157
		DMX07010**	HF-155
400 MXC	04-05	DMX07013*	HF-157
		DMX07010**	HF-155
400 SX	04-05	DMX07013*	HF-157
		DMX07010**	HF-155
400 XC	2007	DMX07013*	HF-157
		DMX07010**	HF-155
450 EXC	03-07	DMX07013*	HF-157
		DMX07010**	HF-155
450 EXC	09-11	DMX07011	HF-652
450 EXC	12-13	DMX07010	HF-655
450 EXC-R	2008	DMX07011	HF-652
		DMX07010**	HF-155
450 MXC	03-06	DMX07013*	HF-157
		DMX07010**	HF-155
450 SMR	05-07	DMX07013*	HF-157
		DMX07010**	HF-155
450 SMR	08-12	DMX07011	HF-652

450 SMR	13-14	DMX07010	HF-655
		DMX07010**	HF-155
450 SX	03-06	DMX07013*	HF-157
450 SX-F	07-12	DMX07011	HF-652
450 SX-F	13-14	DMX07010	HF-655
		DMX07010**	HF-155
450 XC W	07-08	DMX07013*	HF-157
		DMX07010**	HF-155
450 XC	12-14	DMX07010	HF-655
450 XC WR	08-11	DMX07011	HF-652
450 XC-F	08-11	DMX07011	HF-652
450 XC-F	13-14	DMX07010	HF-655
500 EXC	12-14	DMX07010	HF-655
500 XC-W	12-14	DMX07010	HF-655
505 SX-F	07-11	DMX07011	HF-652
505 XC-F	08-11	DMX07011	HF-652
		DMX07010**	HF-155
520 EXC	99-02	DMX07013*	HF-157
		DMX07010**	HF-155
520 MXC	99-02	DMX07013*	HF-157
		DMX07010**	HF-155
520 SX	99-02	DMX07013*	HF-157
		DMX07010**	HF-155
525 EXC	03-07	DMX07013*	HF-157
		DMX07010**	HF-155
525 MXC	03-07	DMX07013*	HF-157
		DMX07010**	HF-155
525 SMR	04-06	DMX07013*	HF-157
		DMX07010**	HF-155
525 SX	03-07	DMX07013*	HF-157
		DMX07010**	HF-155
530 EXC	09-11	DMX07011	HF-652
530 EXC-R	09-11	DMX07011	HF-652
530 EXC-RW	09-11	DMX07011	HF-652
530 XC	09-11	DMX07011	HF-652
		DMX07010**	HF-155
540 SXS	2007	DMX07013*	HF-157
		DMX07010**	HF-155
560 SMR	2007	DMX07013*	HF-157
		DMX07010**	HF-155
620 LC4	98-99	DMX07013*	HF-157
		DMX07010**	HF-155
625 SMC	04-06	DMX07013*	HF-157
		DMX07010**	HF-155
625 SXC	03-05	DMX07013*	HF-157
		DMX07010**	HF-155
660 Rally Factory	06-07	DMX07013*	HF-157
		DMX07010**	HF-155
660 SMC	04-05	DMX07013*	HF-157
		DMX07010**	HF-155
660 Supermoto	02-03	DMX07013*	HF-157
		DMX07010**	HF-155
690 Duke	08-11	DMX07013*	HF-157
		DMX07010**	HF-155
690 Duke R	10-11	DMX07013*	HF-157
		DMX07010**	HF-155
690 Enduro/R	08-11	DMX07013*	HF-157
		DMX07010**	HF-155
690 SMC Duke	08-11	DMX07013*	HF-157
		DMX07010**	HF-155
690 Supermoto R	07-09	DMX07013*	HF-157

RUEDAS Y NEUMÁTICOS

MOTOR

ADMISIÓN / ESCAPE
REFRIGERACIÓN

ELECTRICO

SUSPENSIÓN / DIRECCIÓN

FRENOS

TRANSMISIÓN

CONTROLES Y MANDOS

CHASIS

ACCESORIOS

EMIGO

PSYCHIC

Filtros de aceite

SHERCO

Año	Referencia	Hifo filtro
08-13	DMX07019	HF-611
2010	DMX07019	HF-611
10-13	DMX07019	HF-611
04-13	DMX07019	HF-611
04-10	DMX07019	HF-611
04-13	DMX07019	HF-611
04-10	DMX07019	HF-611

SUZUKI

Año	Referencia	Hifo filtro
03-06	E10-99200	HF-112
85-00	E10-55500	HF-132
03-14	E10-55500	HF-132
94-95	E10-55500	HF-132
03-13	E10-55500	HF-132
82-93	E10-55500	HF-132
03-12	E10-55500	HF-132
86-13	E10-55500	HF-132
90-95	DMC07255	HF-136
01-07	DMC07255	HF-136
04-14	DMX07157	HF-207
00-07	E10-55510	HF-139
00-13	E10-55510	HF-139
05-13	E10-55510	HF-139
05-13	DMX07157	HF-207
10-13	DMX07157	HF-207

TM

Año	Referencia	Hifo filtro
2007	E10-79120	HF-142
08-11	E10-79130	HF-141
2012	E10-79130	HF-141
07-10	E10-79120	HF-142
2011	E10-79130	HF-141
07-11	E10-79130	HF-141
08-09	E10-79120	HF-142

YAMAHA

Año	Referencia	Hifo filtro
99-04	DAT07002	HF-143
82-96	DAT07002	HF-143
09-13	E10-79130	HF-141
09-13	E10-79130	HF-141
93-97	DAT07003	HF-142
05-14	DAT07002	HF-143
00-06	E10-79120	HF-142
09-15	E10-79110	HF-140
01-02	E10-79120	HF-142
03-08	E10-79130	HF-141
09-14	E10-79110	HF-140
2008	E10-79130	HF-141
09-14	E10-79130	HF-141
01-02	E10-79120	HF-142
03-08	E10-79130	HF-141
09-15	E10-79110	HF-140
85-01	DAT07002	HF-143
99-01	E10-79120	HF-142
98-99	E10-79120	HF-142
01-02	E10-79120	HF-142
00-02	E10-79120	HF-142
03-08	E10-79130	HF-141
09-14	E10-79110	HF-140
03-08	E10-79130	HF-141
09-15	E10-79110	HF-140



Aflojafiltros

Referencia	Dimensión	P.V.P.
DMC1236318	65 mm	5,12
E84-04182	67 mm	5,12



Aflojafiltros

Referencia	Dimensión	P.V.P.
DUP12073	60-76 mm	12,63
DUP120731	73-85 mm	12,63





Tapón drenaje imantado

Tapón de drenaje aceite de motor. Aluminio AL6061-T6. Anodizado dorado. La punta interior está imantada para recoger todas las pequeñas impurezas metálicas que pueda generar el motor, minimizando la posibilidad de taponar la bomba de aceite.

P.V.P
12



DMX12959
M8 x 25mm



DMX12960
M8 x 35mm



DMX12961
M10 x 16mm



DMX12962
M10 x 22mm



DMX12963
M12 x 10mm



DMX12964
M8 x 20mm



DMX12965
M10 x 16mm



DMX12966
M12 x 22mm



DMX12967
M6 x 10mm

HONDA	Año	Referencia	Ref. Original
CRF 150 R	07-13	DMX12960	96300-08035-00
CRF 150 R	07-13	DMX12967	90004-GHB-600
CRF 250 R	04-13	DMX12959	96300-08025-00
CRF 250 R	04-13	DMX12967	90004-GHB-600
CRF 250 X	04-13	DMX12959	96300-08025-00
CRF 250 X	04-13	DMX12967	90004-GHB-600
CRF 450 R	02-13	DMX12960	96300-08035-00
CRF 450 R	02-13	DMX12967	90004-GHB-600
CRF 450 X	04-09	DMX12960	96300-08035-00

KAWASAKI	Año	Referencia	Ref. Original
KX 65	00-14	DMX12961	92066-1437
KX85	01-14	DMX12961	92066-1437
KX 100	01-14	DMX12961	92066-1437
KX 125	96-05	DMX12961	92066-1437
KX 250	96-07	DMX12961	92066-1437
KX 250	09-10	DMX12961	92066-1437
KX 250 F	04-08	DMX12961	92066-1437
KX 450 F	06-14	DMX12962	92066-0038
KLX 450	08-13	DMX12962	92066-0038
KX 500	92-04	DMX12961	92066-1437

KTM	Año	Referencia	Ref. Original
TODOS	Todos	DMX12966	58030021000

SUZUKI	Año	Referencia	Ref. Original
DR-Z 70	08-09	DMX12963	09247-12006
DR-Z400	00-13	DMX12963	09247-12006
RM-Z 250	07-13	DMX12963	09247-12006
RM-Z 450	08-13	DMX12964	09103-08393

YAMAHA	Año	Referencia	Ref. Original
YZ 125	07-12	DMX12965	95022-10016-00
YZ 250 F	06-12	DMX12965	95022-10016-00
WR 250 F	06-12	DMX12965	95022-10016-00
YZ 450 F	06-12	DMX12965	95022-10016-00
WR 450 F	06-12	DMX12965	95022-10016-00

XPEED Tapón llenado aceite

Tapón de llenado aceite de motor, fabricado en aluminio y anodizado en diferentes colores. Se entrega con tórica.

P.V.P
6,90

HONDA	Año	Color	Referencia
CR 125	87-04	Oro	R176301D
CR 125	05-07	Rojo	R176302R
CRF 150 F	03-14	Rojo	R176302R
CRF 150 R	07-14	Rojo	R176302R
CRF 230 F	03-10	Rojo	R176302R
CRF 230 L	08-12	Rojo	R176302R
CR 250	05-07	Rojo	R176302R
CRF 250 R	04-14	Rojo	R176302R
CRF 250 X	04-14	Rojo	R176302R
CRF 450 R	02-04	Oro	R176301D
CRF 450 R	05-14	Rojo	R176302R
CRF 450 X	05-14	Rojo	R176302R
TRX 450 R	04-10	Rojo	R176302R
CR 500	87-04	Oro	R176301D

KAWASAKI	Año	Color	Referencia
KX 80	83-03	Oro	R176301D
KX 85	00-04	Oro	R176301D
KX 100	91-05	Oro	R176301D
KX 125	80-04	Oro	R176301D
KX 125	05-08	Oro	R176304D
KDX 220	83-04	Oro	R176301D
KLX 250	94-06	Oro	R176301D
KLX 250 S	08-10	Oro	R176302D
KX 250	80-04	Oro	R176301D
KX 250	05-07	Oro	R176304D
KX 250 F	04-14	Oro	R176304D
KLX 300	94-06	Oro	R176301D
KLX 300	2007	Oro	R176302D
KX 450 F	06-14	Oro	R176304D
KX 500	83-04	Oro	R176301D

KTM	Año	Color	Referencia
65 SX	02-12	Naranja	R176305O
65 XC	02-12	Naranja	R176305O
85 SX	03-12	Naranja	R176305O
85 XC	03-12	Naranja	R176305O
105 SX	03-12	Naranja	R176305O
105 XC	03-12	Naranja	R176305O
125 a 200 2t.	94-05	Naranja	R176305O
250 a 380 2t.	94-12	Naranja	R176305O
450 EXC	08-12	Naranja	R176305O
450 XC-W	08-12	Naranja	R176305O
530 EXC	08-12	Naranja	R176305O
530 XC-W	08-12	Naranja	R176305O

SUZUKI	Año	Color	Referencia
RM 55	2003	Oro	R176301D
RM 60	03-06	Oro	R176301D
RM 80	90-01	Oro	R176303D
RM 85	02-13	Oro	R176303D
RM 100	2003	Oro	R176301D
RM 125	82-07	Oro	R176303D
RM 250	82-08	Oro	R176303D
RMZ 250	04-06	Oro	R176304D
RMZ 250	07-13	Oro	R176303D
RMZ 450	05-13	Oro	R176303D
RMX 450	10-13	Oro	R176303D

YAMAHA	Año	Color	Referencia
YZ 80	93-01	Azul	R176301B
YZ 85	02-14	Azul	R176301B
YZ 125	94-14	Azul	R176301B
YFS 200	89-06	Azul	R176301B
WR 250 F	03-05	Azul	R176301B
WR 250 F	06-10	Oro	R176302D
WR 250 R	08-10	Azul	R176301B
WR 250 X	08-10	Azul	R176301B
YZ 250	99-14	Azul	R176301B
YZ 250 F	03-14	Azul	R176301B
WR 450 F	03-13	Azul	R176301B
YZ 450 F	03-14	Azul	R176301B





Kit bomba de agua Honda CRF 450 02-08

El kit consta de todo el material necesario para reparar la bomba de agua.
Junta de tapa, eje de la bomba, rodamiento y los dos retenes.

Referencia	Descripción	P.V.P.
DMX09258	Honda CRF 450R	24,41



Kit retenes bomba de agua

El kit consta de todo el material necesario para sustituir los retenes de la bomba de agua.
Se sirve sin eje y con juntas.



DMX10217

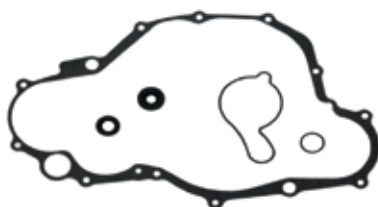

DMX10218



DMX10222

HONDA	Año	Referencia	Nº Piezas	P.V.P.
CR 80	86-07	DMX10207	5	18,61
CR 85	86-07	DMX10207	5	18,61
CR 125 R	90-04	DMX10206	6	19,40
CR 250 R	92-01	DMX10205	6	18,22
CR 250 R	02-04	DMX10203	6	18,22
CR 250 R	05-07	DMX10203	6	18,22
CRF 250 R	04-09	DMX10201	6	17,29
CRF 250 X	04-09	DMX10201	6	17,29
CRF 450 R	02-08	DMX10200	6	19,01
CRF 450 X	05-15	DMX10231	7	23,30

KAWASAKI	Año	Referencia	Nº Piezas	P.V.P.
KX 125	03-05	DMX10211	5	18,88
KX 250 F	04-08	DMX10208	7	20,86
KX 250 F	09-14	DMX10225	8	21,25
KLX 450 R	08-12	DMX10209	4	21,25
KX 450 F	06-08	DMX10209	4	21,25
KX 450 F	09-14	DMX10226	4	21,25

KTM	Año	Referencia	Nº Piezas	P.V.P.
50 Pro-Sr. LC	01-05	DMX10220	3	6,60
50 Supermoto	2006	DMX10220	3	6,60
50 SX	09-12	DMX10221	3	9,77
50 SX Jr.	2009	DMX10221	3	9,77
50 SX Mini	09-12	DMX10221	3	9,77
50 SX Pro-Jr. LC	03-5	DMX10220	3	6,60
50 SX/ SX Jr	06-08	DMX10220	3	6,60
65 SX	00-08	DMX10220	3	6,60
65 SX	09-12	DMX10221	3	9,77
65 XC	2008	DMX10220	3	6,60
65 XC	2009	DMX10221	3	9,77
85 SX	03-04	DMX10222	5	9,77
85 SX 17/14	05-12	DMX10222	5	9,77
85 SX 19/16	05-12	DMX10222	5	9,77
85 XC	08-09	DMX10222	5	9,77
105 SX	04-11	DMX10222	5	9,77
105 XC	08-09	DMX10222	5	9,77
125 EXC	00-01	DMX10223	7	10,96

125 SX	00-12	DMX10223	7	10,96
125 SXS	01-02	DMX10223	7	10,96
125 SXS	07-08	DMX10223	7	10,96
144 SX	07-08	DMX10223	7	10,96
150 SX	09-12	DMX10223	7	10,96
150 XC	10-12	DMX10223	7	10,96
200 EXC	00-05	DMX10223	7	10,96
200 MXC	00-03	DMX10223	7	10,96
200 SX	03-04	DMX10223	7	10,96
250 SX	03-12	DMX10224	3	11,09
250 EXC	04-05	DMX10224	3	11,09
250 XC	06-12	DMX10224	3	11,09
250 XC-W	06-12	DMX10224	3	11,09
250 SXS	2004	DMX10224	3	11,09
300 EXC	04-05	DMX10224	3	11,09
300 MXC	04-05	DMX10224	3	11,09
300 XC	06-12	DMX10224	3	11,09
300 SX-W	06-12	DMX10224	3	11,09

SUZUKI	Año	Referencia	Nº Piezas	P.V.P.
RM 125	04-08	DMX10215	4	17,29
RM 250	01-08	DMX10214	3	17,29
RM-Z 250	04-06	DMX10208	7	20,86
RM-Z 250	07-09	DMX10212	4	20,86
RM-Z 450	05-07	DMX10213	4	20,86
RM-Z 450	08-15	DMX10230	4	21,76

YAMAHA	Año	Referencia	Nº Piezas	P.V.P.
YZ 125	98-04	DMX10232	5	15,82
YZ 125	05-15	DMX10233	5	19,06
WR 250 F	01-13	DMX10219	7	18,88
YZ 250	99-14	DMX10227	4	18,37
YZ 250 F	01-13	DMX10219	7	18,88
WR 450 F	03-06	DMX10217	7	18,88
WR 450 F	07-14	DMX10218	5	19,01
YZ 450 F	03-05	DMX10217	7	18,88
YZ 450 F	07-09	DMX10218	5	19,01
YZF 450	04-09	DMX10218	5	19,01
YZF 450	10-13	DMX10229	5	19,01

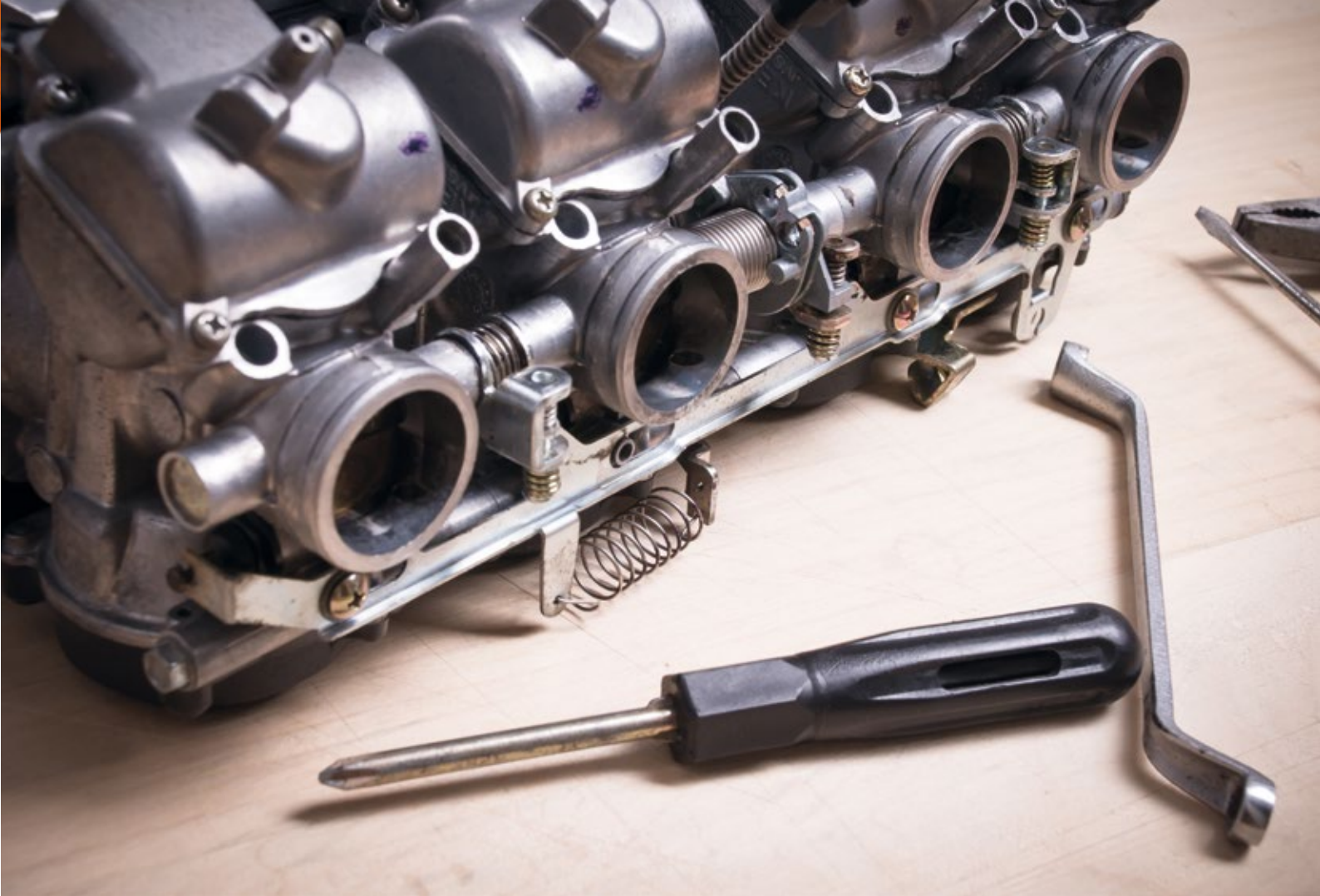

ADMISIÓN ESCAPE REFRIGERACIÓN

ADMISIÓN / ESCAPE / REFRIGERACIÓN



Chiclés carburador

P.V.P
5

Modelo Mikuni SJ

Referencia	Medida	Referencia	Medida	Referencia	Medida	Referencia	Medida
DSJ0725	72,5	DSJ0975	97,5	DSJ1225	122,5	DSJ1475	147,5
DSJ0750	75	DSJ1000	100	DSJ1250	125	DSJ1500	150
DSJ0775	77,5	DSJ1025	102,5	DSJ1275	127,5	DSJ1525	152,5
DSJ0800	80	DSJ1050	105	DSJ1300	130	DSJ1550	155
DSJ0825	82,5	DSJ1075	107,5	DSJ1325	132,5	DSJ1575	157,5
DSJ0850	85	DSJ1100	110	DSJ1350	135	DSJ1600	160
DSJ0875	87,5	DSJ1125	112,5	DSJ1375	137,5	DSJ1700	170
DSJ0900	90	DSJ1150	115	DSJ1400	140		
DSJ0925	92,5	DSJ1175	117,5	DSJ1425	142,5		
DSJ0950	95	DSJ1200	120	DSJ1450	145		

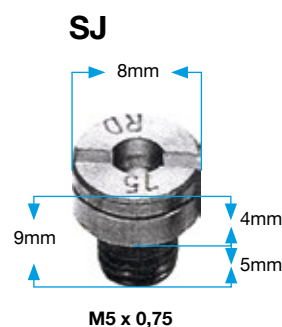

Modelo Mikuni HJ

Referencia	Medida	Referencia	Medida	Referencia	Medida	Referencia	Medida
DHJ0700	70	DHJ1750	175	DHJ3300	330	DHJ5100	510
DHJ0800	80	DHJ1800	180	DHJ3400	340	DHJ5200	520
DHJ0900	90	DHJ1850	185	DHJ3500	350	DHJ5300	530
DHJ1000	100	DHJ1900	190	DHJ3600	360	DHJ5400	540
DHJ1050	105	DHJ1950	195	DHJ3700	370	DHJ5500	550
DHJ1100	110	DHJ2000	200	DHJ3800	380	DHJ5600	560
DHJ1150	115	DHJ2100	210	DHJ3900	390	DHJ5700	570
DHJ1200	120	DHJ2200	220	DHJ4000	400	DHJ5800	580
DHJ1250	125	DHJ2300	230	DHJ4100	410	DHJ5900	590
DHJ1300	130	DHJ2400	240	DHJ4200	420	DHJ6000	600
DHJ1350	135	DHJ2500	250	DHJ4300	430	DHJ6100	610
DHJ1400	140	DHJ2600	260	DHJ4400	440	DHJ6200	620
DHJ1450	145	DHJ2700	270	DHJ4500	450	DHJ6300	630
DHJ1500	150	DHJ2800	280	DHJ4600	460	DHJ6400	640
DHJ1550	155	DHJ2900	290	DHJ4700	470	DHJ6500	650
DHJ1600	160	DHJ3000	300	DHJ4800	480	DHJ6600	660
DHJ1650	165	DHJ3100	310	DHJ4900	490	DHJ6700	670
DHJ1700	170	DHJ3200	320	DHJ5000	500	DHJ6800	680

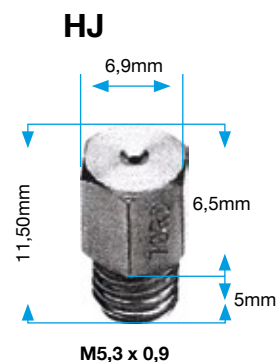

Modelo Keihin KJ

Referencia	Medida	Referencia	Medida	Referencia	Medida	Referencia	Medida
DKJ0725	72,5	DKJ0975	97,5	DKJ1225	122,5	DKJ1475	147,5
DKJ0750	75	DKJ1000	100	DKJ1250	125	DKJ1500	150
DKJ0775	77,5	DKJ1025	102,5	DKJ1275	127,5	DKJ1525	152,5
DKJ0800	80	DKJ1050	105	DKJ1300	130	DKJ1550	155
DKJ0825	82,5	DKJ1075	107,5	DKJ1325	132,5	DKJ1575	157,5
DKJ0850	85	DKJ1100	110	DKJ1350	135	DKJ1600	160
DKJ0875	87,5	DKJ1125	112,5	DKJ1375	137,5	DKJ1650	165
DKJ0900	90	DKJ1150	115	DKJ1400	140	DKJ1700	170
DKJ0925	92,5	DKJ1175	117,5	DKJ1425	142,5	DKJ1900	190
DKJ0950	95	DKJ1200	120	DKJ1450	145		

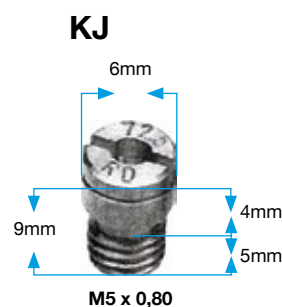

Modelo Keihin CR

Referencia	Medida	Referencia	Medida	Referencia	Medida	Referencia	Medida
DCR0800	80	DCR1200	120	DCR1600	160	DCR2000	200
DCR0820	82	DCR1220	122	DCR1620	162	DCR2020	202
DCR0850	85	DCR1250	125	DCR1650	165	DCR2050	205
DCR0880	88	DCR1280	128	DCR1680	168	DCR2080	208
DCR0900	90	DCR1300	130	DCR1700	170	DCR2100	210
DCR0920	92	DCR1320	132	DCR1720	172	DCR2120	212
DCR0950	95	DCR1350	135	DCR1750	175	DCR2150	215
DCR0980	98	DCR1380	138	DCR1780	178	DCR2180	218
DCR1000	100	DCR1400	140	DCR1800	180	DCR2200	220
DCR1020	102	DCR1420	142	DCR1820	182	DCR2220	222
DCR1050	105	DCR1450	145	DCR1850	185	DCR2250	225
DCR1080	108	DCR1480	148	DCR1880	188	DCR2280	228
DCR1100	110	DCR1500	150	DCR1900	190	DCR2300	230
DCR1120	112	DCR1520	152	DCR1920	192	DCR2320	232
DCR1150	115	DCR1550	155	DCR1950	195	DCR2350	235
DCR1180	118	DCR1580	158	DCR1980	198	DCR2380	238

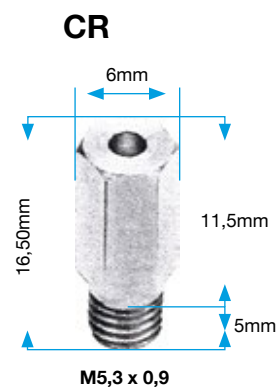



Kit de reparación carburador

El kit de reparación de carburador incluye todo el material indispensable para rehacer todo el carburador.

HONDA	Año	Referencia	P.V.P.
CR 80 R	96-02	DXU07313	24,05
CR 85 R	03-05	DXU07313	24,05
CR 80 RB EXPERT	96-02	DXU07313	24,05
CR 85 RB EXPERT	03-05	DXU07313	24,05
CR 125 R	00-01	DXU07317	22,43
CR 125 R	02-03	DXU07318	22,43
CR 125 R	04-07	DXU07319	33,09
CRF 150 F	06-14	DXU07320	27,30
CRF 230 F	03-05	DXU07323	32,18
CRF 230 F	06-14	DXU07324	20,80
CR 250 R	99-00	DXU07326	20,80
CR 250 R	01-03	DXU07327	22,43
CR 250 R	04-07	DXU07328	33,09
CRF 250 R	2004	DXU07329	31,47
CRF 250 R	2005	DXU07330	31,47
CRF 250 R	06-08	DXU07331	32,13
CRF 250 R	2006	DXU07332	32,13
CRF 250 X	04-06	DXU07333	33,00
XR 400 R	98-04	DXU07336	33,09
CRF 450 R	02-04	DXU07337	31,47
CRF 450 R	05-06	DXU07338	26,43
CRF 450 R	07-08	DXU07339	31,47
CRF 450 X	05-06	DXU07340	33,90
CRF 450 X	07-12	DXU07341	33,90
XR 650 R	00-06	DXU07342	28,93

KAWASAKI	Año	Referencia	P.V.P.
KX 65	02-14	DXU07343	31,72
KX 85	01-05	DXU07344	24,05
KX 125	01-02	DXU07346	20,80
KX 125	03-04	DXU07347	27,30
KX 250	00-04	DXU07348	22,71
KLX 250 S	09-14	DXU07353	32,28
KX 250 F	04-08	DXU07349	31,47
KLR 650	87-07	DXU07350	21,21

KTM	Año	Referencia	P.V.P.
250 SX-F	05-10	DXU07354	41,79
250 XC-F	07-09	DXU07354	41,79
250 XCF-W	07-09	DXU07354	41,79
450 EXC	09-10	DXU07355	42,70
450 SX-F	07-09	DXU07355	42,70
450 XC-W	07-09	DXU07355	42,70
525 EXC 4T	06-07	DXU07355	42,70
525 XC-W	2007	DXU07355	42,70
530 EXC	09-10	DXU07355	42,70

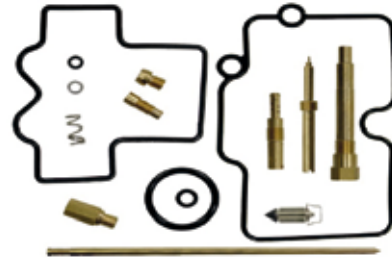

SUZUKI	Año	Referencia	P.V.P.
RM 85	02-06	DXU07356	20,80
RM 85 L	03-06	DXU07356	20,80
RM 125	01-06	DXU07357	23,34
RM 250	01-06	DXU07360	22,43
RM-Z 250	05-06	DXU07349	31,47
RM-Z 250	07-08	DXU07361	33,00
DR-Z 400 S	00-09	DXU07363	33,81
RM-Z 450	05-07	DXU07364	33,00
DR 650 SE	96-09	DXU07365	29,17
XR 650 L	93-09	DXU07366	24,96

YAMAHA	Año	Referencia	P.V.P.
YZ 80	97-01	DXU07369	20,80
YZ 85	02-04	DXU07371	20,80
YZ 85	06-09	DXU07372	29,84
TT-R90R	06-07	DXU07374	29,91
TT-R 125 E	06-07	DXU07396	45,09
TT-R 125 L	06-07	DXU07396	45,09
TT-R 125 LE	06-07	DXU07396	45,09
YZ 125	99-00	DXU07376	22,43
YZ 125	02-04	DXU07377	21,17
YZ 125	05-09	DXU07378	28,79
YZ 250	00-01	DXU07383	24,96
YZ 250	02-04	DXU07384	24,96
YZ 250	07-08	DXU07385	29,84
YZ 250 F	01-02	DXU07386	33,90
YZ 250 F	03-06	DXU07387	32,13
YZ 250 F	07-08	DXU07388	32,13
WR 250 F	05-09	DXU07393	37,73
YZ 426 F	00-02	DXU07390	33,00
YZ 450 F	03-04	DXU07391	28,43
YZ 450 F	05-09	DXU07392	32,13
WR 450 F	05-06	DXU07394	37,87
WR 450 F	07-09	DXU07395	37,87

Extractor de chiclés

Referencia	P.V.P.
DUP12069	9,63



Destornillador curvo

Referencia	P.V.P.
DUP12840	85,82



Galgas Chiclés

Referencia	Medidas (mm)	P.V.P.
DUP12171	Desde 0,45 - 1,5	10,80
DUP121711	Desde 1,5 a 3,0	10,80



RUEDAS Y NEUMÁTICOS

MOTOR

ADMISIÓN / ESCAPE
REFRIGERACIÓN

ELECTRICO

SUSPENSIÓN / DIRECCIÓN

FRENOS

TRANSMISIÓN

CONTROLES Y MANDOS

CHASIS

ACCESORIOS

ADMISIÓN / ESCAPE / REFRIGERACIÓN



Tornillo regulación aire

Tornillo para la mezcla de aire y gasolina, de rápido acceso.
Para carburadores KEIHIN modelo FCR.
Fabricado en aluminio AL6061 T6.



Referencia	Descripción	P.V.P.
DMX07014RD	Rojo	14,84
DMX07014GN	Verde	14,84
DMX07014GL	Oro	14,84
DMX07014BU	Azul	14,84
DMX07014BK	Negro	14,84
DMX07014TI	Titanio	14,84
DMX07014OR	Naranja	14,84



Grifos gasolina

Referencia	Descripción	P.V.P.
DAT07574	Ø 7mm Anclaje Ø 6,6mm a 34mm Tubo 38/29,5mm / 66mm	14,40
DAT07575	Ø 8mm Anclaje Ø 6,6mm a 34mm Tubo 35,8/30mm / 66mm	14,40



Tubo gasolina NBR 5m

Referencia	Descripción	P.V.P.
DMC07043	Tubo Ø 4,8 mm	9,36
DMC070431	Tubo Ø 6,3 mm	9,81
DMC070432	Tubo Ø 8 mm	17,47



Filtros de aire universales

Referencia	Descripción	P.V.P.
DMP07084A1	De espuma roja y boquilla de 28mm	15,10
DMP07084A4	De espuma roja y boquilla de 35mm	15,10
DMP07084A7	De espuma roja y boquilla de 42mm	15,10
DMP07084A11	De espuma roja y boquilla de 50mm	15,10



Brida tubo gasolina 10 und.

Referencia	Descripción	P.V.P.
DSM07046	Ø 8,5 mm	1,80
DSM07045	Ø 9,8 mm	2,80
DSM07049	Ø 11,6 mm	3,30
D07238A	Ø 18 mm	4,40



Láminas de admisión

Marca y recorta las láminas de cualquier modelo.
Placa de carbono específicamente creada para la realización de láminas de admisión.



Referencia	Descripción	P.V.P.
DMP07300	Placa de 50x90 mm y 0,35 mm de espesor	15,60
DMP07301	Placa de 60x100 mm y 0,38 mm de espesor	15,60



Filtro de gasolina

Referencia	Imagen	Descripción	P.V.P.
E14-34441	A	F. Gasolina Grande Ø 6 mm.	0,92
E14-34421	B	F. Gasolina Pequeño Ø 6 mm.	0,79
DUP07101	C	F. Gasolina para tubo Ø 6 mm.	1,20
DUP071011	C	F. Gasolina para tubo Ø 8 mm.	1,30

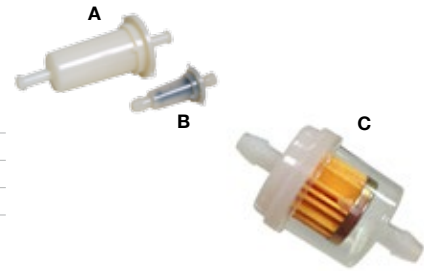

Conector rápido gasolina

Referencia	Descripción	P.V.P.
DAT07040	Tubo Ø 6mm	8,23
DAT070401	Tubo Ø 8mm	9,17



XPEED Válvula tapón gasolina

P.V.P.
6,09

Referencia	Descripción
R250BK	Tubo desvaporador Negro
R250BL	Tubo desvaporador Azul
R250R	Tubo desvaporador Rojo
R250GR	Tubo desvaporador Dorado
DMC07371TI	Tubo desvaporador Titanio



Juego de embudos

Referencia	Descripción	P.V.P.
DUC12201	Ø 50, 75,95, 115 mm	4,80



2 Bolas depósito gasolina de nilón

Referencia	Descripción	P.V.P.
DUP12017	Ø 25 mm	1,99



Provetas medidoras líquido

Referencia	Descripción	P.V.P.
DUP12015	500 ml	3,65
DUP120151	250 ml	3,65



Portachiclés

	Referencia	P.V.P.
1	XSM07067	4,50
2	XSM07022	7,00
3	X0718704	4,70



Limpiador de chiclés

Referencia	P.V.P.
DMP12327	5,93



Depósito gasolina portátil 0,5l.

Referencia	P.V.P.
DUP12185	24,81



ADMISIÓN / ESCAPE / REFRIGERACIÓN



Juntas de escape



Referencia	Ø Exterior	Ø Interior	Ancho
DAT02224	36,0	32,0	32,0

Referencia	Ø Exterior	Ø Interior	Ancho
DMC02208	31,4	25,5	27,7
DAT02207	34,7	28,7	25,2
DAT02225	34,6	28,7	28,2
DMC02213	34,6	28,8	25,5
DMC02227	37,4	31,6	30,8
DAT02209	37,5	31,7	26,7
DMC02221	38,7	31,7	25,0
DMC02211	37,2	32,0	25,0
DAT02229	37,0	32,2	26,2
DMX02156	48,5	34,1	23,5
DMC02228	41,6	34,8	30,1
DAT02228	41,0	35,0	25,0
DAT02222	41,2	35,0	26,0
DAT02230	41,2	35,2	31,3
DMC02232	44,6	38,0	28,3
DMX02150	48,6	38,0	34,5
DMX02153	44,0	38,0	31,0
DAT02227	44,3	38,3	24,5
DMC02205	44,5	38,4	25,0
DMC02217	43,5	38,5	27,6
DMX02151	48,6	40,7	35,3
DMC02210	48,5	42,7	20,6
DMC02235	48,7	42,7	29,0

Referencia	Ø Exterior	Ø Interior	Ancho
DMC02245	43,7	38,2	30,0
DMX02152	48,5	41,3	34,2
DAT02206	46,4	42,0	25,0
DMC02247	49,5	45,0	34,8
DMX02154	54,3	49,0	29,9
DSM02047	34,0	51,0	57,0

Referencia	Ø Exterior	Ø Interior	Ancho
DAT02235	32,7	28,7	30,5
DAT02231	36,3	31,7	30,7
DMC02218	38,6	35,0	25,3
DAT02234	46,8	42,2	25,5

HONDA	Año	CULATA - COLECTOR			COLECTOR - SILENCIOSO		
		Referencia Original	Referencia	P.V.P.	Referencia Original	Referencia	P.V.P.
NX 125	88-90	18291-MN5-650	DAT02220	2,50			
CRF 150 F	03-14	18291-MN5-650	DAT02220	2,50	18391-MB0-891	DMC02213	9,00
CRF 150 R	2005	18291-MN5-650	DAT02220	2,50			
CRF 150 R	06-14				18392-MK4-000	DMC02205	9,00
CRF 150 RB	06-14				18392-MK4-000	DMC02205	9,00
XR 200 R	84-85				18391-438-306	DMC02232	9,00
XR 200 R	88-00	18291-MN5-650	DAT02220	2,50	18391-MB0-891	DMC02213	9,00
XR 200 R	86-87				18391-MB0-891	DMC02213	9,00
CRF 230 F	03-14	18291-MN5-650	DAT02220	2,50	18391-MB0-891	DMC02213	9,00
CRF 230 L	08-09	18291-MN5-650	DAT02220	2,50	18391-ML8-000	DMC02211	9,00
CRF 250 R	07-09	18392-MK4-000	DMC02205	9,00	18391-ML8-000	DMC02211	9,00
CRF 250 R	10-14	18392-MK4-000	DMC02205	9,00			
CRF 250 X	04-13				18392-MK4-000	DMC02205	9,00
XL 250 R	84-87				18391-438-306	DMC02232	9,00
XL 250 S	84-86				18391-MB0-891	DMC02213	9,00
XL 250 S	78-81				18391-MB0-891	DMC02213	9,00
XR 250 L	92-96				18392-ML0-000	DMC02209	10,50
XR 250 R	81-82				18391-429-010	DMC02231	11,70
XR 250 R	84-85				18391-438-306	DMC02232	9,00
XR 250 R	86-89				18392-MK4-000	DMC02205	9,00
XR 350 R	83-84				18391-438-306	DMC02232	9,00
XL 350 R	84-85				18392-MK4-000	DMC02205	9,00
XR 400 R	96-97	18291-MN5-650	DAT02220	2,50			
XR 400 R	98-04	18291-MN5-650	DAT02220	2,50	18392-MK4-000	DMC02205	9,00
CRF 450 R	02-08				18392-MEB-670	DMX02156	9,00
CRF 450 R	09-12				18391-ML0-003	DMC02210	11,50
CRF 450 R (silen. izquierdo)	13-14	18391-ML0-003	DMC02210	11,50	18391-ML8-000	DMC02211	9,00
CRF 450 X	05-14				18392-MEB-670	DMX02156	9,00
XR 500 R	79-83				18391-429-010	DMC02231	11,70
XL 500	79-82				18391-429-010	DMC02231	11,70
XL 600 R	83-87				18391-429-010	DMC02231	11,70
XR 600 R	85-87	18291-MN5-650	DAT02220	2,50	18391-429-010	DMC02231	11,70
XR 600 R	88-90	18291-MN5-650	DAT02220	2,50	18391-MN1-670	DMC02213	9,00
XR 600 R	91-00	18291-MN5-650	DAT02220	2,50	18392-MJ4-670	DMC02235	9,00
XL 600 V Transalp	89-90	18291-MN4-920	DAT02219	2,50			
NX 650	88-89	18291-MN5-650	DAT02220	2,50			
XR 650 L	93-14	18291-MN5-650	DAT02220	2,50	18392-449-000	DMC02235	11,70
XR 650 R	00-07	18291-MN5-650	DAT02220	2,50	18392-MG7-750	DMC02207	10,00
XR 650 R (colector medio)	00-07	18391-MB0-891	DMC02213	9,00			

ADMISIÓN / ESCAPE / REFRIGERACIÓN



Juntas de escape



Referencia	Ø Exterior	Ø Interior	Ancho
DAT02221	54,3 / 44,2	38,6	10,4
DAT02208	56,1 / 48,3	41,7	10,2
DAT02223	58,1	42,6 / 43	14,0



Referencia	Ø Exterior	Ø Interior	Ancho
DAT02213	44,7	38,6	5,3



Referencia	Ø Exterior	Ø Interior	Ancho
DAT02215	39,5	30,8	2,5
DAT02220	40,0	31,7	4,2
DAT02219	43,0	35,0	4,0
DAT02214	45,0	37,1	4,1
DAT02252	46,5	39,9	2,6



Referencia	Ø Exterior	Ø Interior	Ancho
DAT02216	40,5	32,7	3,7
DAT02210	50,0	40,2	5,0



Referencia	Ø Exterior	Ø Interior	Ancho
DAT02211	32,7	22,4	4,1
DAT02212	42,4	31,9	3,4
DAT02217	42,0	35,3	5,5
DAT02218	43,0	34,5	5,0
X1387881	49,5	39,0	5,4
X1387885	42,2	31,8	3,6

KAWASAKI	Año	CULATA - COLECTOR			COLECTOR - SILENCIOSO		
		Referencia Original	Referencia	P.V.P.	Referencia Original	Referencia	P.V.P.
KL 250	90-05				11009-1667	DAT02222	9,00
KL 250	09-10				11061-0360	DMC02211	9,00
KLR 250	90-05				11009-1667	DAT022282	9,00
KLX 250	94-96				11060-1068	DMC02205	9,00
KLX 250	06-14				11061-1055	DMC02216	9,00
KLX 300 R	97-07				11060-1068	DMC02205	9,00
KL 600	84-86				11009-1666	DMC02215	11,70
KL 650 Tengai	90-91				11009-1666	DMC02215	11,70
KLR 650	87-10				11009-1666	DMC02215	11,70
KLX 650	93-96				11009-1666	DMC02215	11,70

SUZUKI	Año	CULATA - COLECTOR			COLECTOR - SILENCIOSO		
		Referencia Original	Referencia	P.V.P.	Referencia Original	Referencia	P.V.P.
DR-Z 250	01-07				14771-13E00	DMC02218	7,50
RM-Z 250	10-13				14771-45G00	DAT02206	13,60
DR 350	90-99				14771-13E00	DMC02218	7,50
RMX 450 Z	10-11				14181-35G00	DAT02252	2,50
RM-Z 450	05-13				14181-35G00	DAT02252	2,50

YAMAHA	Año	CULATA - COLECTOR			COLECTOR - SILENCIOSO		
		Referencia Original	Referencia	P.V.P.	Referencia Original	Referencia	P.V.P.
TW 200	02-14				3YF-14714-00	DMC02227	9,00
XT 225	92-07				3YF-14714-00	DMC02227	9,00
TT-R 225	99-03				3YF-14714-00	DMC02227	9,00
TT-R 225	05-06				4EL-14714-00	DMC02228	10,30
TT-R 230	05-14				3YF-14714-00	DMC02227	9,00
TT-R 250	99-06				4EL-14714-00	DMC02228	9,00
WR 250 F	01-13				5PH-14714-00	DMX02150	10,30
WR 250 R (colector medio)	08-14	5PX-14755-00	DMC02245	10,30			
WR 250 X (colector medio)	08-14	5PX-14755-00	DMC02245	10,30			
YZ 250 F	01-05				3VD-14755-00	DMC02232	9,00
YZ 250 F	06-13				5XD-14714-00	DMX02152	10,30
YZ 250 F (colector medio)	2014	5PX-14755-00	DMC02245	10,30	1SL-14714-00	DMX02154	10,30
XT 250	98-14				3YF-14714-00	DMC02227	9,00
XT 350	92-00				4EL-14714-00	DMC02228	10,30
WR 400 F	98-00				3GW-14714-00	DMX02151	13,60
YZ 400 F	98-99				3GW-14714-00	DMX02151	13,60
WR 426 F	01-02				3GW-14714-00	DMX02151	13,60
WR 450 F	2003				3GW-14714-00	DMX02151	13,60
WR 450 F	07-11				5PH-14714-00	DMX02150	9,00
WR 450 F	12-14				5XD-14714-00	DMX02152	10,30
YZ 426 F	00-02				3GW-14714-00	DMX02151	13,60
YZ 450 F	2003				3GW-14714-00	DMX02151	13,60
YZ 450 F	04-06				5XD-14714-00	DMX02152	10,30
YZ 450 F	07-09				5VY-14714-00	DMC02247	13,60
YZ 450 F (colector medio)	10-13	5PH-14714-00	DMX02150	9,00	8GL-14714-00	DSM02047	13,60
YZ 450 F (colector medio)	14-15	5XD-14714-00	DMX02152	10,30	1SL-14714-00	DMX02154	10,30
TT 600	83-86				3YF-14755-00	DAT02206	13,60
XT 600	84-95				3YF-14755-00	DAT02206	13,60

ADMISIÓN / ESCAPE / REFRIGERACIÓN



Radiadores

Radiador estándar o sobredimensionado.
Se comercializa el kit completo o por radiador suelto.
Se monta sobre anclaje original.
Soldadura del aluminio en TIG.



* Referencias con asterisco indica en qué lado se encuentra el tapón de relleno de anticongelante.

** DXD10019 Sin ubicación para anclaje de ventilador ni termostato.

		COMPLETO		IZQUIERDO		DERECHO		
HONDA	Año	Descripción	Referencia	P.V.P.	Referencia	P.V.P.	Referencia	P.V.P.
CR 85 R	97-08	Sobredimensionado	DXD10008	110				
CR 125	02-04	Estándar	DXD10025	192	DXD10025L	110	DXD10025R*	110
CR 125	05-07	Estándar	DXD10026	192	DXD10026L	110	DXD10026R*	110
CRF 150 R	07-14	Sobredimensionado	DXD10009	192	DXD10009L	110	DXD10009R*	110
CR 250 R	02-04	Estándar	DXD10027	192	DXD10027L	110	DXD10027R*	110
CR 250 R	05-07	Estándar	DXD10028	192	DXD10028L	110	DXD10028R*	110
CRF 250 R	04-09	Sobredimensionado	DXD10000	192	DXD10000L	110	DXD10000R*	110
CRF 250 R	10-13	Estándar	DXD10029	192	DXD10029L	110	DXD10029R*	110
CRF 250 X	04-09	Sobredimensionado	DXD10000	192	DXD10000L	110	DXD10000R*	110
CRF 450	02-04	Sobredimensionado	DXD10012	192	DXD10012L	110	DXD10012R*	110
CRF 450	05-08	Sobredimensionado	DXD10001	192	DXD10001L	110	DXD10001R*	110
CRF 450	09-12	Estándar	DXD10030	192	DXD10030L	110	DXD10030R*	110
CRF 450 X	05-14	Estándar	DXD10056	192	DXD10056L	110	DXD10056R*	110
XR 650 R	00-07	Estándar	DXD10043	192	DXD10043L	110	DXD10043R*	110

		COMPLETO		IZQUIERDO		DERECHO		
HUSABERG	Año	Descripción	Referencia	P.V.P.	Referencia	P.V.P.	Referencia	P.V.P.
FE 250	13-14	Estándar	DXD10020	192	DXD10020L	110	DXD10020R*	110
TE 250	11-13	Estándar	DXD10021	192	DXD10021L	110	DXD10021R*	110
TE 300	11-13	Estándar	DXD10021	192	DXD10021L	110	DXD10021R*	110
FE 350	2013	Estándar	DXD10020	192	DXD10020L	110	DXD10020R*	110
FE 390	10-11	Estándar	DXD10020	192	DXD10020L	110	DXD10020R*	110
FE 450	09-11	Estándar	DXD10020	192	DXD10020L	110	DXD10020R*	110
FE 501	13-14	Estándar	DXD10020	192	DXD10020L	110	DXD10020R*	110

		COMPLETO		IZQUIERDO		DERECHO		
HUSQVARNA	Año	Descripción	Referencia	P.V.P.	Referencia	P.V.P.	Referencia	P.V.P.
CR 125	00-08	Sobredimensionado	DXD10057	192	DXD10057L	110	DXD10057R	110
WR 125	00-08	Sobredimensionado	DXD10057	192	DXD10057L	110	DXD10057R	110
CR 250	00-05	Sobredimensionado	DXD10057	192	DXD10057L	110	DXD10057R	110
WR 250	00-10	Sobredimensionado	DXD10057	192	DXD10057L	110	DXD10057R	110
WR 300	09-10	Sobredimensionado	DXD10057	192	DXD10057L	110	DXD10057R	110
WR 360	00-02	Sobredimensionado	DXD10057	192	DXD10057L	110	DXD10057R	110

		COMPLETO		IZQUIERDO		DERECHO		
KAWASAKI	Año	Descripción	Referencia	P.V.P.	Referencia	P.V.P.	Referencia	P.V.P.
KX 80	2000	Sobredimensionado	DXD10015	110				
KX 85	01-13	Sobredimensionado	DXD10015	110				
KX 100	98-13	Sobredimensionado	DXD10015	110				
KX 125	94-02	Estándar	DXD10041	192	DXD10041L	110	DXD10041R*	110
KX 250 F	94-02	Estándar	DXD10041	192	DXD10041L	110	DXD10041R*	110
KX 250 F	04-05	Sobredimensionado	DXD10011	192	DXD10011L	110	DXD10011R*	110
KX 250 F	2006	Sobredimensionado	DXD10006	192	DXD10006L	110	DXD10006R*	110
KX 250 F	09-10	Estándar	DXD10023	192	DXD10023L	110	DXD10023R*	110
KX 450 F	06-07	Sobredimensionado	DXD10004	192	DXD10004L	110	DXD10004R*	110
KX 450 F	2008	Sobredimensionado	DXD10016	192	DXD10016L	110	DXD10016R*	110
KLX 450	08-09	Sobredimensionado	DXD10016	192	DXD10016L	110	DXD10016R*	110

		COMPLETO		IZQUIERDO		DERECHO		
KTM	Año	Descripción	Referencia	P.V.P.	Referencia	P.V.P.	Referencia	P.V.P.
85 SX	03-10	Estándar	DXD10042	192	DXD10042L	110	DXD10042R*	110
105 SX	03-10	Estándar	DXD10042	192	DXD10042L	110	DXD10042R*	110
125 SX	08-13	Estándar	DXD10021	192	DXD10021L	110	DXD10021R*	110
144 XS	2008	Estándar	DXD10021	192	DXD10021L	110	DXD10021R*	110
150 SX	09-13	Estándar	DXD10021	192	DXD10021L	110	DXD10021R*	110
150 XC	10-13	Estándar	DXD10021	192	DXD10021L	110	DXD10021R*	110
200 XC-W	09-13	Estándar	DXD10021	192	DXD10021L	110	DXD10021R*	110
250 EXC	00-05	Estándar	DXD10055	192	DXD10055L	110	DXD10055R*	110
250 SX	00-05	Estándar	DXD10055	192	DXD10055L	110	DXD10055R*	110
250 SX	08-13	Estándar	DXD10021	192	DXD10021L	110	DXD10021R*	110
250 SX-F	07-12	Estándar	DXD10019	192	DXD10019L	110	DXD10019R*	110



Radiadores

			COMPLETO		IZQUIERDO		DERECHO	
250 SXS-F	2007	Estándar	DXD10019	192	DXD10019L	110	DXD10019R*	110
250 XC-F	08-09	Estándar	DXD10019	192	DXD10019L	110	DXD10019R*	110
250 XC-F	11-12	Estándar	DXD10019	192	DXD10019L	110	DXD10019R*	110
250 XC-W	08-13	Estándar	DXD10021	192	DXD10021L	110	DXD10021R*	110
300 XC	09-13	Estándar	DXD10021	192	DXD10021L	110	DXD10021R*	110
300 XC-W	09-13	Estándar	DXD10021	192	DXD10021L	110	DXD10021R*	110
350 EXC-F	12-14	Estándar	DXD10019	192	DXD10019L	110	DXD10019R*	110
350 SX-F	11-12	Estándar	DXD10019	192	DXD10019L	110	DXD10019R*	110
350 XC-F	11-12	Estándar	DXD10019	192	DXD10019L	110	DXD10019R*	110
350 XCF-W	11-14	Estándar	DXD10019	192	DXD10019L	110	DXD10019R*	110
400 EXC	00-02	Estándar	DXD10055	192	DXD10055L	110	DXD10055R*	110
400 EXC	03-07	Estándar	DXD10040	192	DXD10040L	110	DXD10040R*	110
400 EXC	09-11	Estándar	DXD10019	192	DXD10019L	110	DXD10019R*	110
400 MXC	00-02	Estándar	DXD10055	192	DXD10055L	110	DXD10055R*	110
400 MXC	03-07	Estándar	DXD10040	192	DXD10040L	110	DXD10040R*	110
400 SX	00-02	Estándar	DXD10055	192	DXD10055L	110	DXD10055R*	110
400 XC-W	2007	Estándar	DXD10040	192	DXD10040L	110	DXD10040R*	110
400 XC-W	09-10	Estándar	DXD10020	192	DXD10020L	110	DXD10020R*	110
450 EXC	00-02	Estándar	DXD10055	192	DXD10055L	110	DXD10055R*	110
450 EXC	03-07	Estándar	DXD10040	192	DXD10040L	110	DXD10040R*	110
450 EXC	08-12	Estándar	DXD10019	192	DXD10019L	110	DXD10019R*	110
450 EXC-R	09-10	Estándar	DXD10020	192	DXD10020L	110	DXD10020R*	110
450 MXC	00-02	Estándar	DXD10055	192	DXD10055L	110	DXD10055R*	110
450 MXC	03-07	Estándar	DXD10040	192	DXD10040L	110	DXD10040R*	110
450 SX	00-02	Estándar	DXD10055	192	DXD10055L	110	DXD10055R*	110
450 SMR	08-12	Estándar	DXD10020	192	DXD10020L	110	DXD10020R*	110
450 SX-F	07-12	Estándar	DXD10020	192	DXD10020L	110	DXD10020R*	110
450 SX-F	13-14	Estándar	DXD10019	192	DXD10019L	110	DXD10019R*	110
450 XC-F	06-07	Estándar	DXD10040	192	DXD10040L	110	DXD10040R*	110
450 XC-F	08-12	Estándar	DXD10020	192	DXD10020L	110	DXD10020R*	110
450 XC-F	13-14	Estándar	DXD10019	192	DXD10019L	110	DXD10019R*	110
450 XC-W	06-07	Estándar	DXD10040	192	DXD10040L	110	DXD10040R*	110
500 EXC	12-14	Estándar	DXD10019	192	DXD10019L	110	DXD10019R*	110
500 XC-W	12-14	Estándar	DXD10019	192	DXD10019L	110	DXD10019R*	110
505 SX-F	07-08	Estándar	DXD10020	192	DXD10020L	110	DXD10020R*	110
505 XC-F	08-09	Estándar	DXD10020	192	DXD10020L	110	DXD10020R*	110
520 EXC	00-02	Estándar	DXD10055	192	DXD10055L	110	DXD10055R*	110
520 MXC	00-02	Estándar	DXD10055	192	DXD10055L	110	DXD10055R*	110
520 SX	00-02	Estándar	DXD10055	192	DXD10055L	110	DXD10055R*	110
525 EXC	03-07	Estándar	DXD10040	192	DXD10040L	110	DXD10040R*	110
525 MXC	03-07	Estándar	DXD10040	192	DXD10040L	110	DXD10040R*	110
525 EXC	00-05	Estándar	DXD10055	192	DXD10055L	110	DXD10055R*	110
525 MXC	00-05	Estándar	DXD10055	192	DXD10055L	110	DXD10055R*	110
525 SMR	00-05	Estándar	DXD10055	192	DXD10055L	110	DXD10055R*	110
525 SX	00-05	Estándar	DXD10055	192	DXD10055L	110	DXD10055R*	110
525 XC	00-05	Estándar	DXD10055	192	DXD10055L	110	DXD10055R*	110
525 XC-F	06-07	Estándar	DXD10040	192	DXD10040L	110	DXD10040R*	110
525 XCW	00-05	Estándar	DXD10055	192	DXD10055L	110	DXD10055R*	110
525 XC-W	2007	Estándar	DXD10040	192	DXD10040L	110	DXD10040R*	110
530 EXC	08-11	Estándar	DXD10019	192	DXD10019L	110	DXD10019R*	110
530 EXC-R	08-11	Estándar	DXD10020	192	DXD10020L	110	DXD10020R*	110
530 XC-W	08-11	Estándar	DXD10020	192	DXD10020L	110	DXD10020R*	110

			COMPLETO		IZQUIERDO		DERECHO	
SUZUKI	Año	Descripción	Referencia	P.V.P.	Referencia	P.V.P.	Referencia	P.V.P.
RM 85	02-10	Sobredimensionado	DXD10036	192	DXD10036L	110	DXD10036R*	110
RM-Z 250	04-06	Sobredimensionado	DXD10011	192	DXD10011L	110	DXD10011R*	110
RM-Z 250	07-09	Sobredimensionado	DXD10037	192	DXD10037L	110	DXD10037R*	110
RM-Z 450	2005	Estándar	DXD10018	192	DXD10018L	110	DXD10018R*	110
RM-Z 450	2006	Sobredimensionado	DXD10038	192	DXD10038L	110	DXD10038R*	110
RM-Z 450	2007	Sobredimensionado	DXD10039	192	DXD10039L	110	DXD10039R*	110
RM-Z 450	08-11	Estándar	DXD10045	192	DXD10045L	110	DXD10045R*	110
RMX 450	2010	Estándar	DXD10045	192	DXD10045L	110	DXD10045R*	110

RUEDAS Y NEUMÁTICOS

MOTOR

ADMISIÓN / ESCAPE REFRIGERACIÓN

ELECTRICO

SUSPENSIÓN / DIRECCIÓN

FRENOS

TRANSMISIÓN

CONTROLES Y MANDOS

CHASIS

ACCESORIOS



Radiadores

YAMAHA	Año	Descripción	COMPLETO		IZQUIERDO		DERECHO	
			Referencia	P.V.P.	Referencia	P.V.P.	Referencia	P.V.P.
YZ 85	02-10	Estándar	DXD10010	110				
YZ 125	05-14	Sobredimensionado	DXD10031	192	DXD10031L	110	DXD10031R*	110
WR 250 F	01-05	Sobredimensionado	DXD10005	192	DXD10005L	110	DXD10005R*	110
WR 250 F	07-13	Sobredimensionado	DXD10003	192	DXD10003L	110	DXD10003R*	110
YZ 250	97-01	Estándar	DXD10032	192	DXD10032L	110	DXD10032R*	110
YZ 250	02-14	Estándar	DXD10033	192	DXD10033L	110	DXD10033R*	110
YZ 250 F	01-05	Sobredimensionado	DXD10005	192	DXD10005L	110	DXD10005R*	110
YZ 250 F	2006	Sobredimensionado	DXD10003	192	DXD10003L	110	DXD10003R*	110
YZ 250 F	07-09	Sobredimensionado	DXD10007	192	DXD10007L	110	DXD10007R*	110
YZ 250 F	10-13	Estándar	DXD10034	192	DXD10034L	110	DXD10034R*	110
YZ 426 F	00-05	Sobredimensionado	DXD10014	192	DXD10014L	110	DXD10014R*	110
WR 426 F	00-05	Sobredimensionado	DXD10014	192	DXD10014L	110	DXD10014R*	110
WR 450 F	00-05	Sobredimensionado	DXD10014	192	DXD10014L	110	DXD10014R*	110
YZ 450 F	00-05	Sobredimensionado	DXD10014	192	DXD10014L	110	DXD10014R*	110
YZ 450 F	2006	Sobredimensionado	DXD10002	192	DXD10002L	110	DXD10002R*	110
YZ 450 F	07-09	Sobredimensionado	DXD10017	192	DXD10017L	110	DXD10017R*	110
YZ 450 F	10-13	Estándar	DXD10035	192	DXD10035L	110	DXD10035R*	110

Difusor temperatura radiador

∅ Interior 13,5mm ∅ Exterior 18,8mm

Referencia	P.V.P.
R160010	11,85



Rejas protección radiador

Dimensiones 20x30cm.
Fabricadas en aluminio.

	Referencia	P.V.P.
PLATEADA	DMP12081S	6,44
NEGRA	DMP12081	6,44

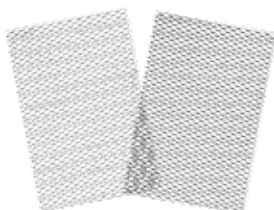

Saca muelles

Referencia	P.V.P.
DUP12351	6,98



Fibra silencioso 1100°C

Referencia	Largo	Ancho	Grosor	P.V.P.
DMC021111	1000 mm	330 mm	6 mm	19,35



XPEED

Tapón silencioso



Referencia	Descripción	P.V.P.
DMX02004	Pequeño Ø10 a 30mm	5,34
DMX02005	Grande Ø27 a 49mm	5,95

ELÉCTRICO



BRONCO Baterías

Todas las baterías Bronco llevan el ácido incluido. Las baterías sin mantenimiento o las baterías secas sólo se pueden recargar con cargadores de impulsos o de baja intensidad de carga.



BRONCO		XPEED	
Referencia	P.V.P.	Referencia	P.V.P.
YT7B-BS	37,99	X02072	33,92
YTX4L-BS	18,59		
YTX5L-BS	22,87	X02050	20,45
YTX7A-BS	29,14		
YTX7L-BS	29,14	X02070	26,90
YTX9-BS	36,10		
YTZ10S	43,83		
YTZ5S	29,82		
YTZ7S	35,62	YTZ7S-BS	32,15

APRILIA	Año	Referencia
450 MXV	06-12	YTX7A-BS
450 RXV	05-09	YTZ10S
450 RXV	10-	YTX7A-BS
450 SXV	05-10	YTZ10S
450 SXV	10-	YTX7A-BS
550 RXV	05-09	YTZ10S
550 RXV	10-	YTX7A-BS
550 SXV	05-09	YTZ10S
550 SXV	10-	YTX7A-BS

BETA	Año	Referencia
250 RR 2t Enduro	12-15	YTZ7S
300 RR 2t Enduro	13-15	YTZ7S
350 RR 4t Enduro	11-15	YTZ7S
350 RR Efi	15-	YTZ7S
390 RR 4t	15-	YTZ7S
400 RR 4t Enduro	05-15	YTZ7S
430 RR 4t	15-	YTZ7S
450 RR 4t Enduro	05-15	YTZ7S
498 RR 4t Enduro	12-15	YTZ7S
525 RR 4t	05-11	YTZ7S

BMW	Año	Referencia
G 450 X	08-11	YTZ7S

GAS-GAS	Año	Referencia
EC 250 F	10-15	YTZ7S
EC 250 FSE 4t	01-09	YTZ7S
EC 250 Racing	09-12	YTZ7S
EC 300 E	11-15	YTZ7S
EC 300 F	15-	YTZ7S
EC 300 Racing	09-15	YTZ7S
EC 300 Six Days	11-15	YTZ7S
EC 400 FSE	01-05	YTZ7S
EC 450 F	15-	YTZ7S
RC 450 Raid	15-	YTZ7S

HM	Año	Referencia
CRE 250 X	09-15	YTZ7S
CRE F 300 X	08-09	YTZ7S
CRE 450 X	09-15	YTZ7S

HONDA	Año	Referencia
CRF 230 F	03-13	YTZ7S
CRF 250 L	08-13	YTZ7S
CRF 250 M	13-	YTX7L-BS
CRF 250 X	04-13	YTZ7S
CRF 450 F	01-15	YTZ7S
CRF 450 Rally	13-15	YTZ7S
CRF 450 X	05-09	YTZ7S
XR 250 R	03-10	YTX7L-BS
XR 600 R	93-93	YTX9-BS
XR 650 L	93-11	YTX9-BS
XR 650 R	00-07	YTX9-BS

HUSABERG	Año	Referencia
350 FE	13-14	YTZ7S
390 FE	10-12	YTZ7S
450 FC	04-11	YTZ7S
450 FE	04-13	YTZ7S
450 FS	04-04	YTZ7S
450 FX	10-13	YTZ7S
501 FE	13-14	YTZ7S
550 FC	06-08	YTZ7S
550 FE	06-08	YTZ7S

HUSQVARNA	Año	Referencia
250 FE	14-15	YTZ7S
250 TC	04-14	YTZ7S
250 TE	05-14	YTZ7S
250 TE-R	13-13	YTZ7S
310 TE	09-13	YTZ7S
310 TE-R	13-13	YTZ7S
410 TE	95-00	YTZ7S
410 TE/E	00-02	YTZ7S
449 TC	11-13	YTZ7S
449 TE	11-13	YTZ7S
450 FC	14-15	YTZ7S
450 SM R	01-04	YTZ7S
450 TC	05-10	YTZ7S
450 TE	05-10	YTZ7S
501 FE	14-15	YTZ7S
510 TC	04-09	YTZ7S
510 TE	95-10	YTZ7S
511 TE	11-13	YTZ7S
570 SM R	01-04	YTZ7S
610 SM R	00-04	YTZ7S
610 TC	95-03	YTZ7S
610 TE	92-03	YTZ7S
630 SM R	06-12	YTZ7S
630 TE	10-12	YTZ7S

KAWASAKI	Año	Referencia
KLX 250 S	05-15	YTX7L-BS
KLX 400 R	03-04	YT7B-BS
KLX 450 R	07-15	YTZ7S

KTM	Año	Referencia
250 EXC 4t	03-05	YTZ7S
250 EXC 2t	05-	YTX4L-BS
250 EXC 2t Six Days	05-	YTX4L-BS
250 EXC-F	05-	YTX5L-BS
250 EXC-F Six Days	05-	YTX4L-BS
250 SX-F	05-	YTX4L-BS
250 XC	05-	YTX4L-BS
250 XC-F	05-	YTX4L-BS
300 EXC	05-	YTX4L-BS
300 EXC Six Days	05-	YTX4L-BS
300 XC	05-	YTX4L-BS
450 EXC	04-14	YTX5L-BS
450 MXC Racing	00-02	YTX5L-BS
450 SXF	07-14	YTX4L-BS
450 XC F	06-14	YTX5L-BS
450 XC W	05-	YTX5L-BS
500 EXC 4t	12-14	YTX5L-BS
500 EXC Six Days	12-14	YTX5L-BS
505 SXF	07-09	YTX5L-BS
525 EXC	03-16	YTZ5S
525 EXC/SX	04-05	YTZ5S
530 EXC-R/XC/W	08-11	YTX5L-BS

SHERCO	Año	Referencia
250 SEF	15-	YTX5L-BS
250 SE-R	15-	YTX5L-BS
250 SEF-R	15-	YTX5L-BS
SX 2.5 F	10-11	YTX5L-BS
SE 2.5 i	12-14	YTX5L-BS
X-Ride 290	13-14	YTX5L-BS
SE 3.0	10-11	YTX5L-BS
SE 3.0 i	12-14	YTX5L-BS
300 SE	15-	YTX5L-BS
300 SEF	15-	YTX5L-BS
300 SE-R	15-	YTX5L-BS
300 SEF-R	15-	YTX5L-BS
SE 4.5 i	12-14	YTX5L-BS
4.5 4t	04-08	YTX5L-BS
450 SEF	15-	YTX5L-BS
450 SEF-R	15-	YTX5L-BS
5.1 4t	06-08	YTX5L-BS
SE 5.1 i	12-14	YTX5L-BS

SUZUKI	Año	Referencia
DR-Z 250	01-07	YTZ7S
DR-Z 400	00-13	YT7B-BS
RMX 450 Z	10-15	YT7B-BS

YAMAHA	Año	Referencia
WR 250 F	03-09	YTZ7S
WR 250 R	08-12	YTZ7S
WR 250 X	08-12	YTZ7S
WR 450 F	03-15	YTZ7S



Cargadores baterías



Cargador automático, carga y mantiene

6V/12V. 1Ah. 3 Fases de carga. Para baterías de 2Ah. a 40Ah.
Carga totalmente automática con desconexión al finalizar la carga.
Función de mantenimiento de carga automático.
Apto para todo tipo de baterías, excepto las de litio.

Referencia	P.V.P.
GBA10	38,13



Cargador automático, carga, mantiene y recupera

12V. 1,5Ah. 5 Fases de carga. Para baterías de 4Ah. a 30Ah y mantenimiento hasta 120Ah
Carga totalmente automática con desconexión al finalizar la carga.
Función de mantenimiento de carga automático.
Recupera baterías sulfatadas.
Apto para todo tipo de baterías, excepto las de litio.

Referencia	P.V.P.
GBS15	46,80



Cargador automático profesional, carga, mantiene y recupera

12V. 1Ah/2Ah/4Ah. 7 Fases de carga. Para baterías de 4Ah. a 140Ah.
Carga totalmente automática con desconexión al finalizar la carga.
Función de mantenimiento de carga automático.
Recupera baterías sulfatadas.
Función de equalización.
Apto para todo tipo de baterías, excepto las de litio.

Referencia	P.V.P.
GBS40	62,53



Comprobador de batería y alternador.
Analiza el estado de la batería y verifica el funcionamiento del alternador.

Referencia	P.V.P.
G142	18,43



Kit conexión permanente con fusible.

Referencia	P.V.P.
G129	10,85



Kit encendedor con fusible, para cargar la batería desde la toma del encendedor.

Referencia	P.V.P.
G150	20,56



Bobina encendido

P.V.P
23,89

Las dos bobinas sirven para la mayoría de motos, compare las medidas del cuadro inferior con las medidas de la bobina original y rápidamente obtendrá la referencia requerida. Si prefiere concretar el modelo llámenos.



DMX01002



DMX01003

Referencia	Largo	Distancia entre agujeros	Ø Agujero	Grosor	Distancia cable	Primario Ohmios	Secundario Ohmios
DMX01002	66mm	55mm	7mm	8.2mm	330mm	0.6	5430
DMX01003	90mm	80mm	6mm	7mm	280mm	0.5	5410

Regulador corriente

Yamaha WR 250 F 03-05
Yamaha WR 450 F 03-04

Referencia	Descripción	P.V.P.
DMX01150	12V - 25A	59,40



Pipa de bujía con resistencia

Yamaha WR 250 R 08-15

Referencia	Descripción	P.V.P.
DSM01123	1,3Ω / 9,6Ω	



Juego conectores macho y hembra



Referencia	Descripción	P.V.P.
DUP01060	2 terminales	2,59



Referencia	Descripción	P.V.P.
DUP01061	3 terminales	3,39



Referencia	Descripción	P.V.P.
DUP01062	4 terminales	4,06

XPEED Pipas de bujía



Referencia	Descripción	P.V.P.
E28-47800	Silicona	1,25



Referencia	Descripción	P.V.P.
D0110904	Tipo NGK	2,22



Referencia	Descripción	P.V.P.
D01110B	Con cable 50cm	3,90



Referencia	Descripción	P.V.P.
D0110924	Silicona con resistencia	5,99



Referencia	Descripción	P.V.P.
D0110923	Silicona con resistencia	5,99



Bujías NGK

Referencia P.V.P.

B10EG	8,26
B10EGV	18,28
B10ES	3,74
B10EVX	12,94
B10HS	3,86
B10HVX	12,94
B5ES	3,74
B5HS	3,22
B6ES	3,67
B6HS	3,67
B7ES	3,67
B7HS	3,67
B8EG	8,26
B8EGV	18,28
B8ES	3,67
B8HS	3,67
B8HVX	12,94
B9EG	8,26
B9EGV	18,28
B9ES	3,67
B9EVX	12,94
B9HS	3,67
B9HVX	12,94
BCP7ES	3,22
BKR5ES	4,63
BKR6E	4,34
BKR7E	5,31
BKR7EIX	19,06
BKR7EKC	9,26
BM6A	3,06
BM6F	3,06
BM7A	3,06
BMR7A	4,66
BP5ES	3,16
BP5HS	3,56
BP6ES	3,16

BP6HS	3,22
BP7ES	3,22
BP7HS	3,22
BP8ES	3,72
BP8HS	3,74
BP9ES	4,63
BPM6A	3,06
BPM7A	3,06
BPMR6F	4,66
BPMR7A	4,23
BPR5ES	3,84
BPR5ES11	3,84
BPR6ES	3,84
BPR6HS	3,84
BPR6HSA	4,71
BPR7EIX	19,06
BPR7ES	3,84
BPR7HS	4,84
BPR8ES	4,84
BPR8HS	4,71
BPR9ES	4,84
BR10ECM	10,14
BR10ECMVX	17,89
BR10ECS	10,14
BR10EG	10,14
BR10EIX	18,89
BR10ES	4,71
BR2LM	4,23
BR4HS	4,66
BR6ES	4,63
BR6HS	4,71
BR6HSA	4,71
BR7ES	4,71
BR7HS	4,84
BR8ECM	10,14
BR8EG	10,14

BR8EIX	18,89
BR8ES	4,84
BR8EVX	17,89
BR8HIX	18,89
BR8HS	4,84
BR8HS10	4,54
BR8HSA	4,71
BR9ECM	10,14
BR9ECS	10,14
BR9EG	10,14
BR9EIX	18,89
BR9ES	4,84
BR9EVX	17,89
BR9HIX	18,89
BR9HS	4,71
C6HSA	3,74
C7HSA	3,74
CMR6H	5,14
CPR6EA9	10,14
CPR7EA9	10,14
CPR8E	10,14
CPR8EA9	10,14
CPR9EA9	10,14
CR10E	10,14
CR10EIX	18,89
CR10EK	11,54
CR6HS	4,71
CR6HSA	4,71
CR7E	10,14
CR7EB	10,14
CR7EH9	12,17
CR7EIX	18,89
CR7EK	11,54
CR7EKB	11,54
CR7HIX	18,89
CR7HS	4,84
CR7HSA	4,71

CR8E	10,14
CR8EB	10,14
CR8EH9	12,17
CR8EHIX9	18,89
CR8EHVX9	17,89
CR8EIB10	13,71
CR8EIX	18,89
CR8EK	11,54
CR8EKB	11,54
CR8EVX	17,89
CR8HIX	18,89
CR8HSA	4,71
CR9E	10,14
CR9EB	10,14
CR9EH9	12,17
CR9EHI9	21,94
CR9EHIX9	18,89
CR9EHVX9	17,89
CR9EIA9	14,43
CR9EIX	18,89
CR9EK	11,71
CR9EKB	14,83
CR9EKPA	14,06
CR9EVX	17,89
D7EA	3,74
D8EA	3,74
D9EA	3,74
DCPR7E	7,31
DCPR8E	8,38
DCPR8EIX	19,06
DCPR8EKC	11,13
DCPR8EKP	19,63
DCPR9E	8,47
DCPR9EIX	19,06
DCPR9EVX	18,31
DPR6EA9	4,71
DPR7EA9	4,84

DPR8EA9	4,84
DPR8EIX-9	18,89
DPR8EVX9	17,89
DPR8Z	10,14
DPR9EA9	4,84
DPR9EIX9	18,89
DPR9EVX9	17,89
DPR9Z	10,14
DR7EA	4,71
DR7ES	4,71
DR8EA	4,84
DR8EB	10,43
DR8EIX	18,89
DR8ES	4,84
DR8ESL	4,84
DR9EA	4,84
IFR8H11	34,54
IFR9H11	34,54
JR8B9	37,31
IMR8C9H	34,54
IMR9A9H	30,60
IMR9B9H	34,54
IMR9C9H	33,26
IMR9C9HES	30,03
IMR9E9HES	30,03
J9A	8,26
JR10B	7,49
JR9B	7,49
JR9C	9,94
LMAR8A9	20,60
MAR10AJ	21,49
PMR8B	32,50

Interruptor



Referencia	Descripción	P.V.P.
DUP01107	Ø 8 mm	5,35



Referencia	Descripción	P.V.P.
DUP011071	Ø 8 mm	5,35



Referencia	Descripción	P.V.P.
DUP01360	Ø 8 mm	5,16



Referencia	Descripción	P.V.P.
D1216604	Ø 8 mm	6,90

Interruptor de freno mecánico



Referencia	Descripción	P.V.P.
E46-50700	YAMAHA	5,84



Referencia	Descripción	P.V.P.
DMX01006	YAMAHA	5,84



Referencia	Descripción	P.V.P.
DMC01698	YAMAHA	13,23

XPEED Interruptor de freno hidráulico



Referencia	Descripción	P.V.P.
DAT01524	HONDA	15,66



Referencia	Descripción	P.V.P.
DMC01323	Japonesas M10 x 1,25	8,47
DMC013231	Europeas M10 x 1,00	8,47



Referencia	Descripción	P.V.P.
DMC013282	Japonesas M10 x 1,25	13,04
DMC013283	Europeas M10 x 1,00	13,04

Conmutador luces



Referencia	Descripción	P.V.P.
DMX01024	KTM, HUSABERG	19,10

Interruptor de embrague



Referencia	Descripción	P.V.P.
DMX01050	HONDA	7,35

XPEED Interruptores de paro



Referencia	Descripción	P.V.P.
DMC010221	KTM	13,68



Referencia	Descripción	P.V.P.
DMC01116	YAMAHA	11,48



Referencia	Descripción	P.V.P.
DMC011181	KTM	10,40



Referencia	Descripción	P.V.P.
DMX01009	YAMAHA	16,93



Referencia	Descripción	P.V.P.
DMX01010	YAMAHA	12,36



Referencia	Descripción	P.V.P.
DMX01007BK	HONDA / KTM / KAWASAKI / SUZUKI / YAMAHA	20,88



Referencia	Descripción	P.V.P.
DMX01008	HONDA	25,20



Referencia	Descripción	P.V.P.
DMC01117	KAWASAKI	10,64



Referencia	Descripción	P.V.P.
DMC01118	KAWASAKI	10,88

XPEED Interruptores de arranque



Referencia	Descripción	P.V.P.
DMX01023	HONDA	22,20



Referencia	Descripción	P.V.P.
DMX010231	HONDA	16,92



Referencia	Descripción	P.V.P.
DMX01011	KAWASAKI	12,71



Referencia	Descripción	P.V.P.
DMX01013	KTM	12,39



Referencia	Descripción	P.V.P.
DMX01014	SUZUKI	13,32



Referencia	Descripción	P.V.P.
DMX01012	YAMAHA	12,71

RUEDAS Y NEUMÁTICOS

MOTOR

ADMISIÓN / ESCAPE
REFRIGERACIÓN

ELÉCTRICO

SUSPENSIÓN / DIRECCIÓN

FRENOS

TRANSMISIÓN

CONTROLES Y MANDOS

CHASIS

ACCESORIOS

XSM01085A



Toma corriente

Referencia	Descripción	P.V.P.
XSM01085A	Toma Mechero	8,58
DUP01251	Toma USB	22,50



Faros halógenos

Precio faro por 1 unidad.
*Instalación eléctrica con todo el material necesario.

Referencia	Descripción	Diámetro	Largo	P.V.P.
DMP01102	A 35W Negro	45	60	15,05
DMP01102P	A 35W Cromado	45	60	15,05
DMP01103	B 50W Negro	60	65	15,80
DMP01666	C 20W Negro	35	50	10,92
DMP01666P	C 20W Cromado	35	50	10,92
DMC01633	Instalación eléctrica, relé, interruptor			15,70



DUP01251

Relés de arranque



Referencia	Descripción	P.V.P.
DAT01097	12V 80A	20,93



Referencia	Descripción	P.V.P.
DAT01098	HONDA	20,00



Referencia	Descripción	P.V.P.
DAT01100	YAMAHA	39,84



Referencia	Descripción	P.V.P.
DAT01105	YAMAHA	21,55



Referencia	Descripción	P.V.P.
DAT01751	HONDA	14,73



Referencia	Descripción	P.V.P.
DMC01696	12V 30A	24,03

Limitador velocidad y RPM

Especialmente concebido para alquileres o niños, donde lo que se pretende es limitar la velocidad y revoluciones del vehículo.

Para ofrecer la máxima seguridad al conductor sin perjudicar el funcionamiento del motor, con un mínimo coste y rapidez.



Referencia	P.V.P.
D12474	25,50



Alargo guardabarros led

Guardabarros con luz led, de posición y freno, homologada.

Referencia	P.V.P.
DMX042241	19,84

SUSPENSIÓN DIRECCIÓN



SUSPENSIÓN / DIRECCIÓN



Kit de reparación dirección



P.V.P
40

APRILIA

Año	Referencia
RXV 550	06-08 DMX08281
SXV 550	06-08 DMX08281

BMW

Año	Referencia
F 650 GS	99-02 DMX08281
F 650 GS Dakar	00-05 DMX08281
F 650 GGS	00-05 DMX08281
F 650 GS M	03-07 DMX08281
F 650 GS K 72	06-10 DMX08281
G 650 GS	08-09 DMX08281

BETA

Año	Referencia
REV 50	06-08 DMX08198
EVO 80	09-11 DMX08198
EVO JR 80	09-11 DMX08198
REV 80	06-08 DMX08198
EVO 2T 125	09-14 DMX08198
REV 2T 125	04-08 DMX08198
EVO 2T 200	09-13 DMX08198
REV 2T 200	04-08 DMX08198
EVO 2T 250	09-13 DMX08198
EVO 4T 250	09-12 DMX08198
REV 2T 250	04-08 DMX08198
REV 4T 250	2008 DMX08198
EVO 2T 290	09-11 DMX08198
EVO 2T 300	12-13 DMX08198
EVO 4T 300	09-12 DMX08198
REV 2T 270	04-08 DMX08198

GAS GAS

Año	Referencia
65 MC	2006 DMX08198
125 Pampera	02-05 DMX08198
125 TXT	02-12 DMX08198
200 TXT	02-09 DMX08198
250 Pampera	02-05 DMX08198
250 TXT	02-12 DMX08198
280 Pampera	02-05 DMX08198
280 TXT	02-12 DMX08198
300 TXT	02-13 DMX08198

HONDA

Año	Referencia
CR 80 R	87-02 DMX08180
CR 80 RB	96-02 DMX08180
CR 85 R	03-07 DMX08180
CR 125 R	85-89 DMX08180
CR 125 R	90-92 DMX08181
CR 125 R	93-07 DMX08182
CR 150 F	03-14 DMX08180
CR 150 R	07-14 DMX08180
CR 150 RB	07-14 DMX08180
XR 200 R	85-02 DMX08180
CRF 230 F	03-14 DMX08180
CR 250 R	85-87 DMX08180
CR 250 R	90-91 DMX08181
CRF 250 R	04-09 DMX08182
CRF 250 R	10-12 DMX08180
CRF 250 X	04-13 DMX08182
XL 250 R	85-87 DMX08180
XR 250 R	85-04 DMX08180
XL 350 R	1985 DMX08180
XR 400 R	96-04 DMX08180
CRF 450 R	02-08 DMX08182

CRF 450 R	09-12	DMX08180
CRF 450 X	05-14	DMX08182
CR 500 R	90-01	DMX08181
XL 600 R	86-87	DMX08180
XL 600 V Transalp	89-90	DMX08180
XR 600 R	85-00	DMX08180
XR 650 L	93-13	DMX08180
XR 650 R	00-07	DMX08181

HUSABERG

Año	Referencia
250 FE	13-14 DMX08190
250 TE	11-14 DMX08190
300 TE	11-14 DMX08190
350 FE	2013 DMX08190
390 FE	10-11 DMX08190
450 FE	09-14 DMX08190
450 FX	10-11 DMX08190
501 FE	13-14 DMX08190
570 FE	09-11 DMX08190
570 FS	10-11 DMX08190

HUSQVARNA

Año	Referencia
TXC 10	2008 DMX08190
CR 125	99-08 DMX08190
WR 125	2008 DMX08190
CR 250	99-04 DMX08190
TC 250	03-08 DMX08190
TE 250	2008 DMX08190
TE 250	2011 DMX08190
TXC 250	2008 DMX08190
WR 250	2008 DMX08190
TE 300	2011 DMX08190
390 FE	10-11 DMX08190
450FE	09-11 DMX08190
450FX	10-11 DMX08190
SM450R	2008 DMX08190
TC450	03-08 DMX08190
TE450	2008 DMX08190
TXC450	2008 DMX08190
TC510	2008 DMX08190
SM510R	2008 DMX08190
570FE	09-11 DMX08190
570FS	10-11 DMX08190
TC570	01-02 DMX08190
SM610	2008 DMX08190
TC610	99-00 DMX08190
TE610	2008 DMX08190

KAWASAKI

Año	Referencia
KX 65	00-14 DMX08184
KX 80	86-00 DMX08184
KX 85	01-14 DMX08184
KX 100	95-14 DMX08184
KX 125	82-91 DMX08295
KX 125	92-05 DMX08187
KLX 125	03-06 DMX08185
KDX 200	83-06 DMX08295
KDX 220	97-05 DMX08295
KDX 250	81-94 DMX08295
KL 250	00-03 DMX08199
KLR 250	85-05 DMX08199
KLX 250	94-96 DMX08199
KLX 250 S	06-12 DMX08199

KLX 250 SF	09-10	DMX08199
KX 250	79-91	DMX08199
KX 250	92-07	DMX08187
KX 250 F	04-14	DMX08187
KLX 300	97-07	DMX08199
KLX 400	2003	DMX08189
KX 400	75-76	DMX08184
KLX 450 R	08-09	DMX08187
KX 450 F	06-14	DMX08187

KTM

Año	Referencia
50 SX	06-14 DMX08198
50 SXS	11-13 DMX08198
50 SM	2006 DMX08198
50 SX Mini	09-14 DMX08198
60 SX	98-00 DMX08198
65 SX	98-14 DMX08198
65 XC	08-09 DMX08198
85 SX	03-14 DMX08198
85 XC	08-09 DMX08198
105 XC	08-09 DMX08198
105 SX	06-11 DMX08198
125 EGS	93-99 DMX08190
125 EXC	93-09 DMX08190
125 EXE	00-01 DMX08190
125 SX	93-14 DMX08190
125 SXS	2004 DMX08190
144 SX	07-08 DMX08190
150 SX	09-14 DMX08190
150 XC	10-14 DMX08190
200 EGS	98-99 DMX08190
200 EXC	98-05 DMX08190
200 MXC	98-03 DMX08190
200 SX	00-04 DMX08190
200 XC	06-09 DMX08190
200 XC-W	06-13 DMX08190
250 EGS	94-99 DMX08190
250 EXC	94-05 DMX08190
250 EXC-G Racing	02-05 DMX08190
250 MXC	98-01 DMX08190
250 SX	94-14 DMX08190
250 SX-F	05-14 DMX08190
250 SXS	01-04 DMX08190
250 XC	06-14 DMX08190
250 XC-F	07-14 DMX08190
250 XC-FW	07-14 DMX08190
300 EGS	94-99 DMX08190
300 EXC	94-05 DMX08190
300 MXC	94-05 DMX08190
300 SX	1994 DMX08190
300 XC	06-14 DMX08190
300 XC-W	06-14 DMX08190
350 LC4	94-95 DMX08190
350 SX-F	11-14 DMX08190
350 XC-F	12-14 DMX08190
360 EGS	96-97 DMX08190
360 EXC	96-97 DMX08190
360 MXC	96-97 DMX08190
360 SX	96-97 DMX08190
380 EGS	98-99 DMX08190
380 EXC	98-02 DMX08190
380 MXC	98-01 DMX08190
380 SX	98-02 DMX08190



Kit de reparación dirección



400 Duke	94-95	DMX08190
400 EGS	94-97	DMX08190
400 EGS-E	1997	DMX08190
400 EXC	94-02	DMX08190
400 EXC-G	04-06	DMX08190
400 LC	98-99	DMX08190
400 LC4-E	00-01	DMX08190
400 LSE	1997	DMX08190
400 MXC	01-02	DMX08190
400 RXC	95-98	DMX08190
400 SC	2000	DMX08190
400 SX	98-02	DMX08190
400 SXC	97-00	DMX08190
400 TXC	1998	DMX08190
400 XC-W	07-10	DMX08190
440 EXC	94-95	DMX08190
440 MXC	1994	DMX08190
440 SX	1994	DMX08190
450 EXC	03-11	DMX08190
450 EXC-G	04-07	DMX08190
450 EXC-R	2008	DMX08190
450 MXC-G	03-05	DMX08190
450 SMR	05-07	DMX08190
450 SMS	03-04	DMX08190
450 SX	03-06	DMX08190
450 SX-F	07-13	DMX08190
450 SXS	03-04	DMX08190
450 XC	04-07	DMX08190
450 XC-F	08-14	DMX08190
450 XC-W	07-14	DMX08190
450 XCR-W	2008	DMX08190
500 LC4	91-92	DMX08190
500 XC-W	12-14	DMX08190
505 SX-F	2008	DMX08190
505 XC-F	08-09	DMX08190
520 EXC	00-02	DMX08190
520 MXC	01-02	DMX08190
520 SX	00-02	DMX08190
525 EXC	03-07	DMX08190
525 SX	03-06	DMX08190
525 MXC-G	03-05	DMX08190
525 SMR	2005	DMX08190
525 XC	06-07	DMX08190
525 XC-W	2007	DMX08190
530 EXC	09-11	DMX08190
530 EXC-R	08-09	DMX08190
530 XCR-W	2008	DMX08190
530 XC-W	09-11	DMX08190
550 MXC	94-96	DMX08190
560 SMR	06-07	DMX08190
600 LC4	91-92	DMX08190
620 Duke	94-97	DMX08190
620 EGS	94-97	DMX08190
620 EGS-E	1997	DMX08190
620 EXC	94-95	DMX08190
620 LC4	97-98	DMX08190
620 LC4 Comp	1999	DMX08190
620 LC4 SuperMoto	1999	DMX08190
620 RXC	95-97	DMX08190
620 SuperMoto	1998	DMX08190
620 SX	97-99	DMX08190
620 SXC	1997	DMX08190
620 TXC	1998	DMX08190
625 SXC	03-05	DMX08190
625 SMC	04-06	DMX08190

640 Adventure	98-07	DMX08190
640 LC4	2005	DMX08190
640 LC4 Adventure	06-07	DMX08190
640 SuperMoto	99-01	DMX08190
690 Duke	2008	DMX08190
690 Rally	2008	DMX08190
690 Enduro	09-12	DMX08190
950 Adventure	03-06	DMX08190
950 Superenduro	2007	DMX08190
950 SM	05-06	DMX08190
990 Adventure	07-12	DMX08190
990 Supermoto	10-11	DMX08190
990 Super Duke	06-08	DMX08190

TM	Año	Referencia
MX 85	06-09	DMX08184
EN 125	96-97	DMX08184
EN 125	02-11	DMX08182
MX 125	96-97	DMX08184
MX 125	02-11	DMX08182
SMX 125	05-08	DMX08182
SMR 125	2009	DMX08182
EN 144	08-11	DMX08182
MX 144	08-11	DMX08182
EN 250	96-97	DMX08184
EN 250	02-11	DMX08182
EN 250 F	02-11	DMX08182
MX 250	96-97	DMX08184
MX 250	02-11	DMX08182
MX 250 F	02-11	DMX08182
EN 300	1997	DMX08184
EN 300	02-11	DMX08182
MX 300	1997	DMX08184
MX 300	02-11	DMX08182
EN 400 F	02-03	DMX08182
MX 400 F	02-03	DMX08182
EN 450 F	04-11	DMX08182
MX 450 F	04-11	DMX08182
SMR 450 F	2009	DMX08182
SMX 450 F	05-07	DMX08182
SM 450 F	2008	DMX08182
EN 530 F	02-11	DMX08182
MX 530 F	02-11	DMX08182
SMR 530 F	08-09	DMX08182
SMX 660	06-07	DMX08182
SMX 660 F	08-09	DMX08182
SMX 660 S	2005	DMX08182

SHERCO	Año	Referencia
Trials 0.80	04-13	DMX08198
Trials 1.25	99-14	DMX08198
Trials 2.0	99-09	DMX08198
Trials 2.5	99-13	DMX08198
Trials 2.9	99-13	DMX08198
Trials 3.0	2013	DMX08198
Trials 3.2 4T	07-09	DMX08198

SUZUKI	Año	Referencia
RM 65	03-05	DMX08184
RM 100	2003	DMX08184
DR 125 S	94-96	DMX08197
DRZ 125 L	03-08	DMX08189
RM 125	1988	DMX08197
RM 125	89-90	DMX08197
RM 125	93-04	DMX08189
RM 125	05-08	DMX08284
DRZ 125	03-08	DMX08185
DRZ 125 L	03-08	DMX08185
DR 200	86-88	DMX08197
DR 250	90-93	DMX08197
RM 250	93-04	DMX08189
RM 250	05-08	DMX08284
RMX 250	93-98	DMX08189
RMZ 250	04-06	DMX08187
RMZ 250	07-08	DMX08284
RMZ 250	09-12	DMX08197
DR-Z 400 E	00-07	DMX08189
DR-Z 400 K	00-04	DMX08189
DR-Z 400 S	00-12	DMX08189
DR-Z 400 SM	05-09	DMX08189
RMX 450	2010	DMX08197
RMZ 450	05-07	DMX08284
RMZ 450	08-12	DMX08197
DR 650 SE	96-11	DMX08189

YAMAHA	Año	Referencia
YZ 80	93-01	DMX08184
YZ 85	02-12	DMX08184
YZ 125	96-12	DMX08193
TT 230 R	05-12	DMX08295
XT 250	08-12	DMX08184
YZ 250	96-12	DMX08193
YZ 250 F	01-12	DMX08193
WR 250 F	01-12	DMX08193
WR 250 R	08-12	DMX08193
WR 250 X	08-12	DMX08193
YZ 400 F	98-99	DMX08193
WR 400 F	98-00	DMX08193
YZ 426 F	00-02	DMX08193
WR 426 F	00-02	DMX08193
YZ 450 F	03-12	DMX08193
WR 450 F	03-11	DMX08193

RUEDAS Y NEUMÁTICOS

MOTOR

ADMISIÓN / ESCAPE
REFRIGERACIÓN

ELECTRICO

SUSPENSIÓN / DIRECCIÓN

FRENOS

TRANSMISIÓN

CONTROLES Y MANDOS

CHASIS

ACCESORIOS

SUSPENSIÓN / DIRECCIÓN



Kit reparación bieleta

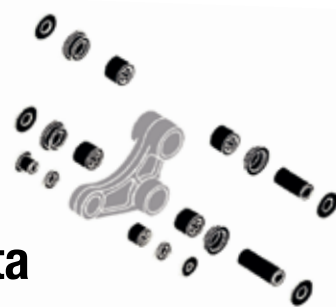

HONDA	Año	Referencia	P.V.P.
XR 80 R	01-03	DMX04108	40,98
CR 80	96-02	DMX041061	44,35
CR 85	03-07	DMX041061	44,35
CRF 80 F	04-13	DMX04108	40,98
CRF 100 F	04-13	DMX04108	40,98
CR 125 R	94-95	DMX04526	
CR 125 R	1996	DMX041013	66,71
CR 125 R	1997	DMX041011	53,01
CR 125 R	98-99	DMX041021	51,10
CR 125 R	00-01	DMX041031	57,07
CR 125 R	02-04	DMX042481	60,54
CR 125 R	05-07	DMX042482	69,01
CRF 150 F	03-14	DMX041091	57,17
CRF 150 R	07-14	DMX041471	53,71
CRF 150 RB	07-14	DMX041471	53,71
CRF 230 F	03-14	DMX041091	57,17
CR 250 R	94-95	DMX04526	
CR 250 R	1996	DMX041013	66,71
CR 250 R	1997	DMX041012	50,70
CR 250 R	98-99	DMX041021	51,10
CR 250 R	00-01	DMX041031	57,07
CR 250 R	02-04	DMX042481	60,54
CR 250 R	05-07	DMX041251	69,01
CRF 250 R	2004	DMX042481	60,54
CRF 250 R	05-09	DMX042482	69,01
CRF 250 R	10-14	DMX04167	70,31
CRF 250 X	2006	DMX041251	69,01
CRF 250 X	07-13	DMX041291	69,01
CRF 450 R	02-04	DMX042481	60,54
CRF 450 R	05-08	DMX041251	69,01
CRF 450 R	09-14	DMX04167	70,31
CRF 450 X	05-13	DMX041251	69,01
CR 500 R	96-01	DMX041051	73,35
KAWASAKI	Año	Referencia	P.V.P.
KX 60	85-03	DMX04113	44,53
KX 65	00-01	DMX04114	47,80
KX 65	02-14	DMX041151	58,59
KX 80	90-00	DMX041241	54,75
KX 85	01-14	DMX041241	54,75
KX 100	98-14	DMX041241	54,75
KLX 125	03-06	DMX04525	50,82
KX 125	94-98	DMX041211	50,82
KX 125	99-03	DMX04123	45,73
KX 125	04-05	DMX042501	63,36
KDX 200	95-06	DMX041211	50,82
KDX 220	95-06	DMX041211	50,82
KLX 250	95-96	DMX04283	57,00
KX 250	1998	DMX041212	45,35
KX 250	99-03	DMX04123	45,73
KX 250	04-07	DMX042501	63,36
KX 250 F	04-05	DMX042501	63,36
KX 250 F	06-14	DMX04281	60,11
KLX 300 R	93-07	DMX04283	57,00
KLX 400	2003	DMX041491	52,67
KLX 450 R	08-09	DMX04281	60,11
KX 450 F	06-14	DMX04281	60,11

KTM	Año	Referencia	P.V.P.
125 SX	12-14	DMX04168	82,57
150 SX	12-14	DMX04168	82,57
150 XC	12-14	DMX04168	82,57
250 SX	12-14	DMX04168	82,57
250 SX-F	11-14	DMX04168	82,57
250 XC	12-14	DMX04168	82,57
250 XC-F	11-14	DMX04168	82,57
300 XC	12-14	DMX04168	82,57
350 SX-F	11-14	DMX04168	82,57
350 XC-F	12-14	DMX04168	82,57
450 SX-F	11-13	DMX04168	82,57
450 XC-F	13-14	DMX04168	82,57
SUZUKI	Año	Referencia	P.V.P.
RM 65	03-05	DMX041151	58,59
RM 80	90-01	DMX041451	64,12
RM 85	02-04	DMX041451	64,12
RM 85	05-12	DMX041452	59,68
RM 85 L	05-12	DMX041452	59,68
RM 100	2003	DMX042521	75,08
DR-Z 125	03-13	DMX04525	50,82
RM 125	93-95	DMX04143	46,50
RM 125	96-97	DMX041411	59,57
RM 125	98-99	DMX041421	46,66
RM 125	2000	DMX04144	44,02
RM 125	2001	DMX041461	53,13
RM 125	02-03	DMX041462	53,25
RM 125	2004	DMX042521	75,08
RM 125	05-07	DMX041171	71,83
RM 250	93-95	DMX04143	46,50
RM 250	96-97	DMX041411	59,57
RM 250	98-99	DMX041421	46,66
RM 250	2000	DMX04144	44,02
RM 250	2001	DMX041461	53,13
RM 250	02-03	DMX041462	53,25
RM 250	2004	DMX042521	75,08
RM 250	05-09	DMX041171	71,83
RM 250	05-09	DMX041171	71,83
RM-Z 250	04-06	DMX042501	63,36
RM-Z 250	07-09	DMX041171	71,83
RM-Z 250	10-12	DMX041501	68,46
RM-Z 250	2013	DMX04524	
DR-Z 400 E	00-07	DMX041491	52,67
DR-Z 400 SL	00-14	DMX041491	52,67
DR-Z 400 SM	05-14	DMX041491	52,67
RM-Z 450	05-09	DMX041171	71,83
RM-Z 450	10-12	DMX041501	68,46
RMX 450	2010	DMX04150	

YAMAHA	Año	Referencia	P.V.P.
YZ 80	93-01	DMX041621	63,80
YZ 85	03-14	DMX041622	60,43
YZ 125	94-00	DMX041611	65,21
YZ 125	2001	DMX041612	63,04
YZ 125	02-04	DMX041631	61,19
YZ 125	2005	DMX042531	80,62
YZ 125	06-14	DMX04522	78,45
WR 250	94-97	DMX041611	65,21
WR 250 F	2001	DMX041612	63,04
WR 250 F	02-04	DMX041631	61,19
WR 250 F	2005	DMX042531	80,62
WR 250 F	2006	DMX04282	69,95
WR 250 F	07-13	DMX041641	78,77
YZ 250	94-00	DMX041611	65,21
YZ 250	2001	DMX041612	63,04
YZ 250	02-04	DMX041631	61,19
YZ 250	2005	DMX042531	80,62
YZ 250	06-14	DMX04522	78,45
YZ 250 F	2001	DMX041612	63,04
YZ 250 F	02-04	DMX041631	61,19
YZ 250 F	2005	DMX042531	80,62
YZ 250 F	2006	DMX04164	71,28
YZ 250 F	2007	DMX042821	76,82
YZ 250 F	2008	DMX042822	78,45
YZ 250 F	09-14	DMX041661	75,52
WR 400 F	98-00	DMX041611	65,21
YZ 400 F	98-99	DMX041611	65,21
WR 426 F	01-02	DMX041612	63,04
YZ 426 F	2000	DMX041611	65,21
YZ 426 F	2001	DMX041612	63,04
WR 450 F	03-04	DMX041631	61,19
WR 450 F	2005	DMX042531	80,62
WR 450 F	07-14	DMX041641	78,77
YZ 450 F	03-04	DMX041631	61,19
YZ 450 F	2005	DMX042531	80,62
YZ 450 F	06-08	DMX041641	78,77
YZ 450 F	09-14	DMX041661	75,52



Control de horquilla

P.V.P
54



Retenedor de horquilla delantera para controlar la salida en carreras
Fabricado en aluminio mecanizado AL 6061-T6

HONDA	Año	Referencia
CR 80 R	96-02	DMX04004
CR 85 R	03-14	DMX04004
CR 125 R	98-14	DMX04005
CRF 150	03-14	DMX04004
CR 250 R	98-14	DMX04006
CRF 250 R	04-14	DMX04006
CRF 250 X	04-14	DMX04006
CRF 450 R	02-07	DMX04006
CRF 450 X	05-07	DMX04006

KAWASAKI	Año	Referencia
KX 80	98-00	DMX04007
KX 85	01-14	DMX04007
KX 100	98-14	DMX04007
KX 125	99-03	DMX04008
KX 125	04-10	DMX04011
KX 250	99-03	DMX04008
KX 250	04-10	DMX04011
KXF 250 F	04-05	DMX04011
KXF 250 F	07-14	DMX04015
KXF 450	07-14	DMX04008

KTM	Año	Referencia
65 SX	00-14	DMX04009
125 SX	02-14	DMX04009
200 SX	03-14	DMX04009
250 SX	02-14	DMX04009
400 SX	2002	DMX04009
450 SX	03-06	DMX04009
520 SX	2002	DMX04009

SUZUKI	Año	Referencia
RM 85	02-14	DMX04010
RM 125	01-14	DMX04011
RM 250	01-03	DMX04012
RM 250	04-06	DMX04011
RMZ 250	04-06	DMX04012
RMZ 250	07-14	DMX04020
RMZ 450	05-06	DMX04011
RMZ 450	07-14	DMX04020

YAMAHA	Año	Referencia
YZ 80	93-01	DMX04013
YZ 85	02-14	DMX04013
YZ 125	98-04	DMX04014
YZ 125	05-07	DMX04016
YZ 125	08-09	DMX04019
YZ 125	10-14	DMX04021
WR 250 F	01-14	DMX04014
YZ 250	98-04	DMX04014
YZ 250	05-07	DMX04016
YZ 250	08-09	DMX04019
YZ 250	10-14	DMX04021
YZ 250 F	98-04	DMX04014
YZ 250 F	05-07	DMX04016
YZ 250 F	08-09	DMX04019
YZ 250 F	10-14	DMX04021
WR 400 F	98-00	DMX04014
YZ 400 F	98-99	DMX04014
WR 426 F	01-02	DMX04014
YZ 426 F	00-02	DMX04014
WR 450 F	03-14	DMX04014
YZ 450 F	03-04	DMX04014
YZ 450 F	05-07	DMX04016
YZ 450 F	08-09	DMX04019
YZ 450 F	10-14	DMX04021

PSYCHIC Sangrados de horquilla

Fabricado en aluminio AL 6061
Anodizado en diferentes colores



P.V.P
11,80



Referencia	Color	Descripción
DMX08051	PLATEADO	M5 0.8 MM Horquillas Showa-Kayaba
DMX08052	DORADO	M4 0.7 MM Horquillas europeas
DMX08053	NEGRO	M4 0.7 MM Horquillas europeas

PSYCHIC Sangrados de horquilla mini

Fabricado en acero inoxidable mucho más resistentes.

P.V.P
15,80



Referencia	Color	Descripción
DMX08049	PLATEADO	M4 0.7 MM Horquillas europeas

XPEED Protector horquilla neopreno

Referencia	P.V.P.
DMX12039	13,64

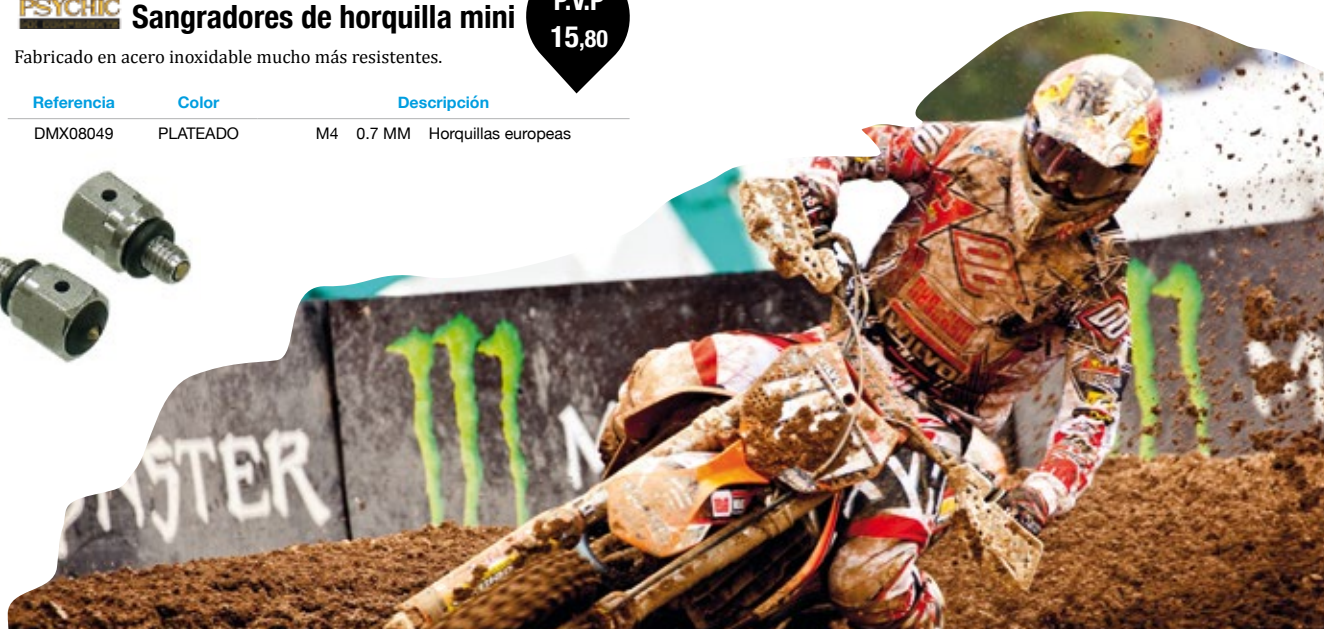

RUEDAS Y NEUMÁTICOS

MOTOR

ADMISIÓN / ESCAPE
REFRIGERACIÓN

ELÉCTRICO

SUSPENSIÓN / DIRECCIÓN

FRENOS

TRANSMISIÓN

CONTROLES Y MANDOS

CHASIS

ACCESORIOS



Kit reparación basculante

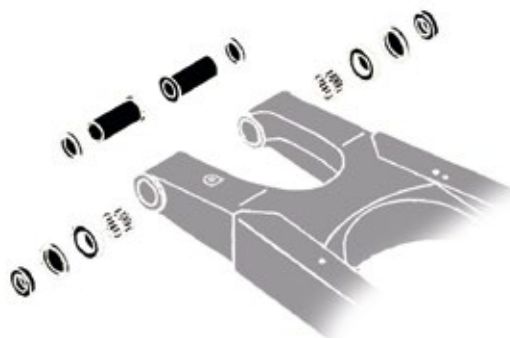

GAS GAS	Año	Referencia	P.V.P.
EC 125	02-11	DMX04293	63,63
MC 125	02-09	DMX04293	63,63
MX 125	02-07	DMX04293	63,63
SM 125	02-08	DMX04293	63,63
EC 200	02-11	DMX04293	63,63
MC 200	02-07	DMX04293	63,63
MX 200	02-07	DMX04293	63,63
SM 200	02-07	DMX04293	63,63
EC 250	02-11	DMX04293	63,63
MC 250	02-09	DMX04293	63,63
MX 250	02-07	DMX04293	63,63
SM 250	02-07	DMX04293	63,63
EC 300	02-11	DMX04293	63,63
MC 300	02-07	DMX04293	63,63
MX 300	02-07	DMX04293	63,63
SM 300	02-07	DMX04293	63,63

HONDA	Año	Referencia	P.V.P.
CRF 50 F	04-14	DMX04256	47,67
XR 50 R	00-03	DMX04256	47,67
XR 70 R	00-03	DMX04256	47,67
CRF 70 F	04-11	DMX04256	47,67
CR 80 R	96-97	DMX04175	32,27
CR 80 R	98-99	DMX04177	33,46
CR 80 R	00-02	DMX04178	34,23
CRF 80 F	04-09	DMX04294	52,00
CR 85 R	03-07	DMX04178	34,23
XR 100 R	85-03	DMX04294	52,00
CRF 100 F	04-11	DMX04294	52,00
CR 125 R	89-92	DMX04173	53,69
CR 125 R	93-01	DMX04174	49,63
CR 125 R	02-07	DMX04179	50,61
CRF 150 R	07-14	DMX04178	34,23
CRF 150 RB	07-14	DMX04178	34,23
CRF 230 F	03-14	DMX04295	49,00
CR 250 R	88-91	DMX04173	53,69
CR 250 R	92-01	DMX04176	52,71
CR 250 R	02-07	DMX04180	51,17
CRF 250 R	04-09	DMX04257	54,95
CRF 250 R	10-13	DMX04383	54,39
CRF 250 R	2014	DMX04385	51,17
CRF 250 X	04-09	DMX04257	54,95
CRF 450 R	02-04	DMX04180	51,17
CRF 450 R	05-08	DMX04297	53,27
CRF 450 R	09-12	DMX04383	54,39
CRF 450 R	13-14	DMX04385	51,17
CRF 450 X	05-14	DMX04297	53,27
CR 500 R	89-01	DMX04173	53,69

HUSABERG	Año	Referencia	P.V.P.
FE 250	2013	DMX04196	52,99
TE 250	12-13	DMX04196	52,99
TE 300	12-13	DMX04196	52,99
FE 350	2013	DMX04196	52,99
FE 450 E	09-10	DMX04198	53,13
FX 450 C	2010	DMX04198	53,13
FE 501	2013	DMX04198	53,13
FE 570 E	09-12	DMX04198	53,13

KAWASAKI	Año	Referencia	P.V.P.
KX 60	99-01	DMX04186	35,21
KX 65	00-14	DMX04186	35,21
KX 80	83-00	DMX04186	35,21
KX 85	01-14	DMX04186	35,21
KX 100	95-14	DMX04186	35,21
KX 125	86-91	DMX04182	40,25
KX 125	96-97	DMX04183	54,95
KX 125	1998	DMX04184	53,41
KX 125	99-05	DMX04185	53,41
KDX 200	89-94	DMX04182	40,25
KDX 200	95-06	DMX04181	42,49
KDX 220	97-05	DMX04181	42,49
KDX 250	91-94	DMX04182	40,25
KX 250	86-91	DMX04182	40,25
KX 250	96-97	DMX04183	54,95
KX 250	1998	DMX04184	53,41
KX 250	99-07	DMX04185	53,41
KX 250 F	04-05	DMX04187	54,25
KX 250 F	06-14	DMX04290	59,57
KLX 300 R	97-07	DMX04182	40,25
KLX 450 R	08-09	DMX04290	59,57
KX 450 F	06-14	DMX04290	59,57

KTM	Año	Referencia	P.V.P.
125 EXC	98-03	DMX04194	45,99
125 EXC	04-05	DMX04196	52,99
125 MXC	98-03	DMX04194	45,99
125 SX	98-03	DMX04194	45,99
125 SX	04-14	DMX04196	52,99
150 SX	09-14	DMX04196	52,99
150 XC	10-14	DMX04196	52,99
200 EXC	98-03	DMX04194	45,99
200 EXC	04-05	DMX04196	52,99
200 MXC	98-03	DMX04194	45,99
200 MXC	04-05	DMX04196	52,99
200 SX	98-03	DMX04194	45,99
200 SX	04-06	DMX04196	52,99
200 XC	06-09	DMX04196	52,99
200 XC-W	07-14	DMX04196	52,99
250 EXC	98-03	DMX04194	45,99
250 EXC Racing	2004	DMX04198	53,13



250 EXC	04-05	DMX04196	52,99
250 MXC	98-03	DMX04194	45,99
250 SX	98-02	DMX04194	45,99
250 SX	03-14	DMX04196	52,99
250 SX-F	06-14	DMX04196	52,99
250 XC	06-14	DMX04196	52,99
250 XC-F	07-14	DMX04196	52,99
250 XC-W	06-14	DMX04196	52,99
250 XCF-W	07-14	DMX04196	52,99
300 EXC	98-03	DMX04194	45,99
300 EXC	04-08	DMX04196	52,99
300 MXC	98-03	DMX04194	45,99
300 MXC	04-05	DMX04196	52,99
300 SX	98-02	DMX04194	45,99
300 XC	06-11	DMX04196	52,99
300 XC-W	06-11	DMX04196	52,99
350 SX-F	2011	DMX04196	52,99
380 EXC	98-02	DMX04194	45,99
380 MXC	98-02	DMX04194	45,99
380 SX	98-02	DMX04194	45,99
400 EXC	00-02	DMX04195	47,25
400 EXC-G	2006	DMX04198	53,13
400 MXC	00-02	DMX04195	47,25
400 SX	00-06	DMX04195	47,25
450 EXC	2003	DMX04195	47,25
450 EXC	04-13	DMX04198	53,13
450 EXC-G	06-09	DMX04198	53,13
450 EXC-R	04-09	DMX04198	53,13
450 MXC	2003	DMX04195	47,25
450 MXC	04-05	DMX04198	53,13
450 SX	2003	DMX04195	47,25
450 SX	04-06	DMX04198	53,13
450 SX-F	07-12	DMX04196	52,99
450 XC	2007	DMX04196	52,99
450 XC-F	08-13	DMX04196	52,99
450 XC-G	2006	DMX04198	53,13
450 XC-W	07-14	DMX04198	53,13
500 EXC	12-14	DMX04198	53,13
500 XC-W	12-14	DMX04198	53,13
505 SX-F	08-09	DMX04196	52,99
505 XC-F	08-09	DMX04196	52,99
520 EXC	00-02	DMX04195	47,25
520 MXC	00-02	DMX04195	47,25
520 SX	00-02	DMX04195	47,25
525 EXC	2003	DMX04195	47,25
525 EXC	04-05	DMX04198	53,13
525 EXC-G	06-07	DMX04198	53,13
525 MXC	2003	DMX04195	47,25
525 MXC	04-05	DMX04198	53,13
525 SX	2003	DMX04195	47,25
525 SX	04-06	DMX04198	53,13
525 XC	06-07	DMX04196	52,99
525 XC-W	2007	DMX04196	52,99
530 EXC	09-11	DMX04198	53,13
530 EXC-R	08-10	DMX04198	53,13
530 XC-W	08-11	DMX04198	53,13

SUZUKI

Año	Referencia	P.V.P.	
RM 65	03-05	DMX04186	35,21
RM 80	96-01	DMX04190	39,55
RM 85	2002	DMX04190	39,55
RM 85	03-12	DMX04192	54,11
RM 100	2003	DMX04186	35,21
DR 125	94-96	DMX04291	55,93
RM 125	96-00	DMX04188	54,81
RM 125	01-03	DMX04189	51,59
RM 125	04-07	DMX04193	54,11
DR 200	86-04	DMX04291	37,03
RM 250	96-00	DMX04188	54,81
RM 250	01-03	DMX04189	51,59
RM 250	04-08	DMX04193	54,11
RM-Z 250	04-06	DMX04187	54,25
RM-Z 250	07-09	DMX04193	54,11
RM-Z 250	10-13	DMX04197	57,19
DR-Z 400 E	00-07	DMX04191	55,93
DR-Z 400 S	00-08	DMX04191	55,93
DR-Z 400 SM	05-09	DMX04191	55,93
RM-Z 450	05-13	DMX04193	54,11
RMX 450	2010	DMX04193	54,11

YAMAHA

Año	Referencia	P.V.P.	
YZ 80	93-98	DMX04240	41,30
YZ 80	99-01	DMX04241	41,65
YZ 85	02-14	DMX04241	41,65
YZ 125	94-97	DMX04238	53,97
YZ 125	99-01	DMX04236	53,97
YZ 125	02-04	DMX04242	58,31
YZ 125	05-14	DMX04258	62,65
WR 250	91-93	DMX04237	60,48
WR 250	94-97	DMX04238	53,97
WR 250 F	2001	DMX04236	53,97
WR 250 F	02-05	DMX04242	58,31
WR 250 F	06-13	DMX04380	60,69
YZ 250	88-92	DMX04237	60,48
YZ 250	93-97	DMX04238	53,97
YZ 250	99-01	DMX04236	53,97
YZ 250	02-04	DMX04242	58,31
YZ 250	05-14	DMX04259	58,31
YZ 250 F	2001	DMX04236	53,97
YZ 250 F	02-06	DMX04242	58,31
YZ 250 F	07-13	DMX04380	60,69
YZ 250 F	2014	DMX04287	56,77
WR 400 F	99-00	DMX04236	53,97
YZ 400 F	1999	DMX04236	53,97
WR 426 F	2001	DMX04236	53,97
WR 426 F	2002	DMX04242	58,31
YZ 426 F	00-01	DMX04236	53,97
YZ 426 F	2002	DMX04242	58,31
WR 450 F	03-05	DMX04242	58,31
WR 450 F	06-14	DMX04380	60,69
YZ 450 F	03-05	DMX04242	58,31
YZ 450 F	06-09	DMX04380	60,69
YZ 450 F	10-14	DMX04287	56,77
WR 500 Z	92-93	DMX04237	60,48



Kit reparación casquillos amortiguador trasero



GAS GAS	Año	Referencia	P.V.P.
EC 125	02-11	DMX04135	27,09
MC 125	02-09	DMX04135	27,09
MX 125	02-07	DMX04135	27,09
SM 125	02-08	DMX04135	27,09
EC 200	02-11	DMX04135	27,09
MC 200	02-07	DMX04135	27,09
MX 200	02-07	DMX04135	27,09
SM 200	02-07	DMX04135	27,09
EC 250	02-11	DMX04135	27,09
MC 250	02-09	DMX04135	27,09
MX 250	02-07	DMX04135	27,09
SM 250	02-07	DMX04135	27,09
EC 300	02-11	DMX04135	27,09
MC 300	02-07	DMX04135	27,09
MX 300	02-07	DMX04135	27,09
SM 300	02-07	DMX04135	27,09

HONDA	Año	Referencia	27,09
CR 80	96-02	DMX04112	31,01
CR 85	03-07	DMX04112	31,01
CR 125	97-04	DMX04111	53,27
CR 125 R	05-07	DMX04254	54,11
CRF 150 R	07-14	DMX04136	31,57
CRF 150 RB	07-14	DMX04136	31,57
CRF 150 F	03-14	DMX04137	22,75
CRF 230 F	03-14	DMX04137	22,75
CR 250	97-04	DMX04111	53,27
CR 250 R	05-07	DMX04254	54,11
CRF 250 R	04-05	DMX04111	53,27
CRF 250 R	06-14	DMX04254	54,11
CRF 250 X	04-05	DMX04111	53,27
CRF 250 X	05-13	DMX04254	54,11
CRF 450 F	02-06	DMX04111	53,27
CRF 450 R	02-04	DMX04111	53,27
CRF 450 R	05-14	DMX04254	54,11
CRF 450 X	05-14	DMX04254	54,11

HUSABERG	Año	Referencia	P.V.P.
FE 250	2013	DMX04247	60,69
TE 250	12-13	DMX04247	60,69
TE 300	12-13	DMX04247	60,69
FE 350	2013	DMX04247	60,69
FE 390 E	2010	DMX04247	60,69
FX 450 C	2010	DMX04247	60,69
FE 450 E	09-10	DMX04247	60,69
FE 501	2013	DMX04247	60,69
FE 570 E	09-10	DMX04247	60,69

KAWASAKI	Año	Referencia	P.V.P.
KX 65	00-14	DMX04119	21,91
KX 80	98-00	DMX04131	31,15
KX 85	01-15	DMX04131	31,15
KX 100	98-15	DMX04131	31,15
KX 125	89-97	DMX04120	31,43
KX 125	98-07	DMX04131	31,15
KLX 125	03-06	DMX04156	19,81
KDX 200	89-06	DMX04132	24,85
KDX 220	97-05	DMX04132	24,85
KDX 250	91-04	DMX04132	24,85
KLX 250	95-96	DMX04132	24,85
KX 250	89-97	DMX04120	31,43
KX 250	98-07	DMX04131	31,15
KX 250 F	04-05	DMX04131	31,15
KX 250 F	06-15	DMX04131	31,15
KLX 300 R	97-07	DMX04132	24,85

KLX 400	2003	DMX04156	19,81
KLX 400	03-05	DMX04151	42,77
KLX 450 R	08-09	DMX04131	31,15
KX 450 F	06-15	DMX04131	31,15
KX 500	89-04	DMX04120	31,43
KLX 650	93-96	DMX04132	24,85

KTM	Año	Referencia	P.V.P.
125 EXC	99-01	DMX04246	59,85
125 EXC	02-05	DMX04247	60,69
125 MXC	02-05	DMX04247	60,69
125 SX	99-01	DMX04246	59,85
125 SX	02-11	DMX04247	60,69
150 SX	09-13	DMX04247	60,69
150 XC	10-11	DMX04247	60,69
200 EXC	99-01	DMX04246	59,85
200 EXC	02-06	DMX04247	60,69
200 MXC	02-05	DMX04247	60,69
200 SX	99-01	DMX04246	59,85
200 SX	02-04	DMX04247	60,69
200 XC	06-14	DMX04247	60,69
200 XC-W	06-14	DMX04247	60,69
250 EXC	99-01	DMX04246	59,85
250 EXC	02-05	DMX04247	60,69
250 EXC 2t	2004	DMX04247	60,69
250 EXC 4t	2004	DMX04247	60,69
250 MXC	02-05	DMX04247	60,69
250 SX	99-01	DMX04246	59,85
250 SX	02-08	DMX04247	60,69
250 SX-F	06-07	DMX04247	60,69
250 XC	06-11	DMX04247	60,69
250 XC-W	06-14	DMX04247	60,69
250 XC-F	07-11	DMX04247	60,69
250 XCF-W	06-14	DMX04247	60,69
300 EXC	99-01	DMX04246	59,85
300 EXC	02-05	DMX04247	60,69
300 MXC	02-05	DMX04247	60,69
300 SX	99-01	DMX04246	59,85
300 SX	2002	DMX04247	60,69
300 XC	06-11	DMX04247	60,69
300 XC-W	06-14	DMX04247	60,69
350 XCF-W	12-14	DMX04247	60,69
380 EXC	99-01	DMX04246	59,85
380 EXC	2002	DMX04247	60,69
380 MXC	99-01	DMX04246	59,85
380 MXC	2002	DMX04247	60,69
380 SX	99-01	DMX04246	59,85
380 SX	2002	DMX04247	60,69
400 EXC	00-01	DMX04246	59,85
400 EXC	2002	DMX04247	60,69
400 EXC-G	2006	DMX04247	60,69
400 MXC	00-01	DMX04246	59,85
400 MXC	2002	DMX04247	60,69
400 SX	00-01	DMX04246	59,85
400 SX	02-06	DMX04247	60,69
400 XC-W	07-10	DMX04247	60,69
450 EXC	03-13	DMX04247	60,69
450 EXC-G	06-09	DMX04247	60,69
450 EXC-R	03-09	DMX04247	60,69
450 MXC	03-05	DMX04247	60,69
450 SX	03-06	DMX04247	60,69
450 SX-F	07-10	DMX04247	60,69
450 XC	06-07	DMX04247	60,69
450 XC-F	08-09	DMX04247	60,69
450 XC-W	07-12	DMX04247	60,69
505 SX-F	2008	DMX04247	60,69

520 EXC	00-01	DMX04246	59,85
520 EXC	2002	DMX04247	60,69
520 MXC	00-01	DMX04246	59,85
520 MXC	2002	DMX04247	60,69
520 SX	00-01	DMX04246	59,85
520 SX	2002	DMX04247	60,69
525 EXC	03-06	DMX04247	60,69
525 MXC	03-06	DMX04247	60,69
525 SX	2006	DMX04247	60,69
525 XC-F	2007	DMX04247	60,69
530 EXC-R	08-10	DMX04247	60,69
530 XC-W	08-11	DMX04247	60,69

SUZUKI	Año	Referencia	P.V.P.
RM 65	03-05	DMX04119	21,91
RM 80	90-01	DMX04153	30,03
RM 85	02-04	DMX04153	30,03
RM 85	05-12	DMX04255	21,63
RM 100	2003	DMX04131	31,15
RM 125	96-99	DMX04155	39,97
RM 125	2000	DMX04151	42,77
RM 125	2001	DMX04152	32,55
RM 125	02-07	DMX04154	31,43
RM 250	96-99	DMX04155	39,97
RM 250	2000	DMX04151	42,77
RM 250	2001	DMX04152	32,55
RM 250	02-08	DMX04154	31,43
RM-Z 250	04-06	DMX04131	31,15
RM-Z 250	07-09	DMX04154	31,43
RM-Z 250	10-13	DMX04390	36,89
DR-Z 400 E	00-06	DMX04151	42,77
DR-Z 400 K	00-04	DMX04151	42,77
DR-Z 400 S	00-13	DMX04151	42,77
DR-Z 400 SM	00-12	DMX04151	42,77
RMX 450	2010	DMX04390	36,89
RM-Z 450	05-09	DMX04154	31,43
RM-Z 450	10-13	DMX04390	36,89

YAMAHA	Año	Referencia	P.V.P.
YZ 80	93-01	DMX04169	29,68
YZ 85	2002	DMX04169	29,68
YZ 85	03-14	DMX04170	28,07
YZ 125	98-00	DMX04171	45,29
YZ 125	01-14	DMX04172	44,17
WR 250 F	01-13	DMX04172	44,17
YZ 250	98-00	DMX04171	45,29
YZ 250	01-14	DMX04172	44,17
YZ 250 F	01-06	DMX04172	44,17
YZ 250 F	07-14	DMX04139	43,26
YZ 400 F	98-99	DMX04171	45,29
WR 426 F	01-02	DMX04172	44,17
YZ 426 F	2000	DMX04171	45,29
YZ 426 F	01-02	DMX04172	44,17
WR 450 F	98-00	DMX04171	45,29
WR 450 F	03-14	DMX04172	44,17
YZ 450 F	03-14	DMX04172	44,17

FRENOS





Pastillas freno sinterizadas

CARACTERÍSTICAS DE LAS PASTILLAS DE FRENO.

Orgánicas FF: Recomendadas para todo tipo de vehículos con conducción normal y paseo, y cualquier tipo de superficie, ya sea seca o mojada. Mezcla de Carbón Kevlar y fibras arámidas DuPont. Estas proporcionan una gran duración y poco desgaste del disco de freno, con una gran potencia de frenada.

Sinterizadas FG: Son las mejores pastillas para Off-Road. El material de alta densidad consiste en una mezcla de Cobre, Carbón, Estaño y otros elementos metálicos.

Ofrece excelente rendimiento y estabilidad en todas las temperaturas, reduce el desgaste y no hay diferencia de funcionamiento en condiciones secas o mojadas. Desgasta más el disco de freno. Recomendadas para todo tipo de terrenos: secos, barro, arena...



Orgánica



Sinterizada

Sinterizadas HH: Recomendadas para asfalto y carreras. Estas reclaman el índice más alto, H en frío y H en caliente. Estas pastillas ofrecen la máxima frenada y sin deterioro, ofreciendo la mayor seguridad de conducción. Menor desgaste al reducir la transferencia de calor aumentando al máximo la vida útil de la pastilla (en conducción en barro o arena su desgaste es considerable). No disponible para off-road.

PSYCHIC		GALFER		
Referencia	P.V.P.	Referencia	P.V.P.	Compuesto
		FD012B	13,00	G1054
		FD048B	14,50	G1054
DMP05080F	16,30	FD065B	9,90	G1054
		FD074B	18,00	G1054
DAT05560F	18,02	FD075E	22,00	G1396
DAT05404F	14,67	FD076E	22,00	G1396
		FD079B	17,90	G1054
		FD080B	20,20	G1054
		FD082B	22,60	G1054
		FD084B	16,20	G1054
		FD085B	22,00	G1054
E64-71971	16,45	FD086E	22,00	G1396
		FD089B	19,70	G1054
DMC05264F	19,86	FD091E	22,00	G1396
DAT05407F	17,79	FD092E	22,00	G1396
E64-51880	16,76	FD093E	22,00	G1396
		FD094E	22,00	G1396
E64-51866	15,32	FD095E	22,00	G1396
		FD097B	17,90	G1054
E64-81372	16,96	FD114E	22,00	G1396
		FD128B	19,50	G1054
		FD133B	15,50	G1054
DMC05554F	16,87	FD138E	22,00	G1396
		FD162B	15,60	G1054
DMX05286F	16,91	FD164E	22,00	G1396
DMC05553F	17,98	FD165E	22,00	G1396
		FD172ST	20,30	G1370
		FD177B	23,00	G1054
DMX05265F	19,86	FD204E	22,00	G1396
		FD223B	18,50	G1054
		FD224B	18,50	G1054
		FD225B	14,90	G1054
		FD230E	19,40	G1396
		FD252B	19,50	G1054
		FD252B	19,50	G1054
		FD254E	22,00	G1396
		FD265E	20,60	G1396
		FD266B	24,60	G1054
		FD270B	18,00	G1054
DMX05002F	16,32	FD278E	22,00	G1396
DMX05272F	19,96	FD286E	22,00	G1396
DMX05001F	16,32	FD291E	22,00	G1396
DAT05505F	14,67	FD299B	15,60	G1054
		FD362E	22,00	G1396
DMX05291F	16,91	FD364E	22,00	G1396
		FD409E	22,00	G1396
		FD441E	22,00	G1396
		FD450B	16,70	G1054
		FD456B	18,90	G1054
		FD458B	17,40	G1054



Compuesto G1396

Pastilla metálica (sinterizada). Compuesto especial para Off-Road. Muy buen comportamiento en seco y en mojado, bajo desgaste en barro y polvo. Máxima frenada.



Compuesto G1054

Pastilla semi-metálica (orgánica). Compuesto mixto para todo tipo de vehículos de mediana cilindrada. Buen comportamiento en seco y en mojado.



Compuesto G1370

Pastilla metálica (sinterizada). Compuesto especial para todo tipo de vehículos. Muy buen comportamiento en seco y en mojado, bajo desgaste. Máxima frenada.

	DELANTERAS				TRASERAS				
	PSYCHIC - EMGO		GALFER		PSYCHIC - EMGO		GALFER		
AJP	Año	Referencia	P.V.P.	Referencia	P.V.P.	Referencia	P.V.P.	Referencia	P.V.P.
PR 4 125 Enduro	05-09			FD133B	15,50			FD223B	18,50
PR 4 125 Enduro/Pro	10-			FD162B	15,60			FD252B	19,50
PR 4 200 Enduro/Pro	10-			FD162B	15,60			FD252B	19,50
Enduro 250	05-			FD133B	15,50			FD223B	18,50
PR 5 250 Enduro	09-10	DMX05286F	16,91	FD164E	22,00	E64-51880	16,76	FD093E	22,00
PR 5 250 Enduro	11-			FD409E	22,00	E64-51880	16,76	FD093E	22,00
ALFER	Año	Referencia	P.V.P.	Referencia	P.V.P.	Referencia	P.V.P.	Referencia	P.V.P.
125 VR 4T	03-	DMC05554F	16,87	FD138E	22,00	DMC05553F	17,98	FD165E	22,00
125 VR 4T No Limits	03-	DMC05554F	16,87	FD138E	22,00	DMC05553F	17,98	FD165E	22,00
250 AR	92-92			FD089B	19,70	DAT05560F	18,02	FD075E	22,00
250 AR	93-	DMC05554F	16,87	FD138E	22,00	DAT05560F	18,02	FD075E	22,00
250 VR	94-94	DMC05554F	16,87	FD138E	22,00	DAT05560F	18,02	FD075E	22,00
250 VR Enduro	95-	DMC05554F	16,87	FD138E	22,00	DMC05553F	17,98	FD165E	22,00
250 VR Motocross	95-	DMC05554F	16,87	FD138E	22,00	DMC05553F	17,98	FD165E	22,00
250 No Limits	95-	DMC05554F	16,87	FD138E	22,00	DMC05553F	17,98	FD165E	22,00
APRILIA	Año	Referencia	P.V.P.	Referencia	P.V.P.	Referencia	P.V.P.	Referencia	P.V.P.
MXV 450	07-	DMX05286F	16,91	FD164E	22,00	DMX05272F	19,96	FD286E	22,00
RXV 450	06-	DMX05286F	16,91	FD164E	22,00	DMX05272F	19,96	FD286E	22,00
RXV 550	07-	DMX05286F	16,91	FD164E	22,00	DMX05272F	19,96	FD286E	22,00
BETA	Año	Referencia	P.V.P.	Referencia	P.V.P.	Referencia	P.V.P.	Referencia	P.V.P.
125 RR 4t	06-			FD162B	15,60			FD456B	18,90
125 RR Enduro	08-			FD162B	15,60			FD456B	18,90
250 RR 4t	05-	DMX05286F	16,91	FD164E	22,00			FD456B	18,90
250 RR 2t Enduro	12-	DMX05286F	16,91	FD164E	22,00			FD456B	18,90
300 RR 2t Enduro	13-	DMX05286F	16,91	FD164E	22,00			FD456B	18,90
300 Xtrainer	15-	DMX05286F	16,91	FD164E	22,00			FD456B	18,90
350 RR 4T	11-12	DMX05286F	16,91	FD164E	22,00			FD456B	18,90
350 RR 4t Enduro	13-	DMX05286F	16,91	FD164E	22,00			FD456B	18,90
350 RR Efi	15-	DMX05286F	16,91	FD164E	22,00			FD456B	18,90
390 RR 4t	15-	DMX05286F	16,91	FD164E	22,00			FD456B	18,90
400 RR 4t	05-12	DMX05286F	16,91	FD164E	22,00			FD456B	18,90
400 RR 4t Enduro	13-	DMX05286F	16,91	FD164E	22,00			FD456B	18,90
430 RR 4t	15-	DMX05286F	16,91	FD164E	22,00			FD456B	18,90
450 RR 4t	05-12	DMX05286F	16,91	FD164E	22,00			FD456B	18,90
450 RR 4t Enduro	13-	DMX05286F	16,91	FD164E	22,00			FD456B	18,90
480 RR 4t	15-	DMX05286F	16,91	FD164E	22,00			FD456B	18,90
498 RR 4t	12-12	DMX05286F	16,91	FD164E	22,00			FD456B	18,90
498 RR 4t Enduro	13-	DMX05286F	16,91	FD164E	22,00			FD456B	18,90
525 RR 4t	05-	DMX05286F	16,91	FD164E	22,00			FD456B	18,90
BMW	Año	Referencia	P.V.P.	Referencia	P.V.P.	Referencia	P.V.P.	Referencia	P.V.P.
G 450 X	08-	DMC05554F	16,87	FD138E	22,00	DMX05001F	16,32	FD291E	22,00
450 Sport Enduro	08-	DMC05554F	16,87	FD138E	22,00	DMX05001F	16,32	FD291E	22,00
GAS GAS	Año	Referencia	P.V.P.	Referencia	P.V.P.	Referencia	P.V.P.	Referencia	P.V.P.
65 MC	06-			FD224B	18,50			FD224B	18,50
70 EC Enducross Boy	99-			FD225B	14,90			FD225B	14,90
Enducross 80	94	DMC05554F	16,87	FD138E	22,00			FD074B	18,00
EC 125	94-00	DMC05554F	16,87	FD138E	22,00			FD074B	18,00



		DELANTERAS				TRASERAS			
		PSYCHIC - EMGO		GALFER		PSYCHIC - EMGO		GALFER	
EC 125	01-14	DMX05286F	16,91	FD138E	22,00	E64-51880	16,76	FD093E	22,00
EC 125	15-	DMX05286F	16,91	FD164E	22,00	DMX05272F	19,96	FD286E	22,00
EC 125 Six Days	11-	DMX05286F	16,91	FD164E	22,00	DMX05272F	19,96	FD286E	22,00
Enduro TT 125	93-	DMC05554F	16,87	FD138E	22,00	DAT05560F	18,02	FD075E	22,00
Enducamp 4t 125	05-			FD162B	15,60	E64-51880	16,76	FD093E	22,00
MC 125	94-00	DMC05554F	16,87	FD138E	22,00			FD074B	18,00
MC 125	01-	DMX05286F	16,91	FD164E	22,00	E64-51880	16,76	FD093E	22,00
TT 125	95-	DMC05554F	16,87	FD138E	22,00	DMC05553F	17,98	FD165E	22,00
EC 200	99-00	DMC05554F	16,87	FD138E	22,00	DMC05553F	17,98	FD165E	22,00
EC 200	01-	DMX05286F	16,91	FD164E	22,00	E64-51880	16,76	FD093E	22,00
EC 200 Six Days	11-	DMX05286F	16,91	FD164E	22,00	DMX05272F	19,96	FD286E	22,00
EC 250	95-98	DMC05554F	16,87	FD138E	22,00	DAT05560F	18,02	FD075E	22,00
EC 250	99-00	DMC05554F	16,87	FD138E	22,00	DMC05553F	17,98	FD165E	22,00
EC 250	01-	DMX05286F	16,91	FD164E	22,00	E64-51880	16,76	FD093E	22,00
EC 250 E	11-	DMX05286F	16,91	FD164E	22,00	DMX05272F	19,96	FD286E	22,00
EC 250 F	10-	DMX05286F	16,91	FD164E	22,00	DMX05272F	19,96	FD286E	22,00
EC 250 FSE	01-	DMX05286F	16,91	FD164E	22,00	E64-51880	16,76	FD093E	22,00
EC 250 Racing	09-	DMX05286F	16,91	FD164E	22,00	E64-51880	16,76	FD093E	22,00
EC 250 Six Days	11-	DMX05286F	16,91	FD164E	22,00	DMX05272F	19,96	FD286E	22,00
EC 250 YR	12-	DMX05286F	16,91	FD164E	22,00	DMX05272F	19,96	FD286E	22,00
FSE 250 4T	99-	DMC05554F	16,87	FD138E	22,00	DMC05553F	17,98	FD165E	22,00
MC 250	95-98	DMC05554F	16,87	FD138E	22,00	DAT05560F	18,02	FD075E	22,00
MC 250	99-00	DMC05554F	16,87	FD138E	22,00	DMC05553F	17,98	FD165E	22,00
MC 250	01-	DMX05286F	16,91	FD164E	22,00	E64-51880	16,76	FD093E	22,00
TT 250	95-	DMC05554F	16,87	FD138E	22,00	DMC05553F	17,98	FD165E	22,00
EC 300	99-00	DMC05554F	16,87	FD138E	22,00	DMC05553F	17,98	FD165E	22,00
EC 300	01-	DMX05286F	16,91	FD164E	22,00	E64-51880	16,76	FD093E	22,00
EC 300 E	11-	DMX05286F	16,91	FD164E	22,00	DMX05272F	19,96	FD286E	22,00
EC 300 F	15-	DMX05286F	16,91	FD164E	22,00	DMX05272F	19,96	FD286E	22,00
EC 300 Six Days	11-	DMX05286F	16,91	FD164E	22,00	DMX05272F	19,96	FD286E	22,00
EC 300 Racing	09-	DMX05286F	16,91	FD164E	22,00	DMX05272F	19,96	FD286E	22,00
EC 400 FSE	99-00	DMC05554F	16,87	FD138E	22,00	DMC05553F	17,98	FD165E	22,00
EC 400 FSE	01-	DMX05286F	16,91	FD164E	22,00	E64-51880	16,76	FD093E	22,00
Enducamp 400 4T	05-			FD162B	15,60	E64-51880	16,76	FD093E	22,00
Pampera 400	06-	DMX05286F	16,91	FD164E	22,00	E64-51880	16,76	FD093E	22,00
EC 450 F	15-	DMX05286F	16,91	FD164E	22,00	DMX05272F	19,96	FD286E	22,00
EC 450 FSE	03-	DMX05286F	16,91	FD164E	22,00	E64-51880	16,76	FD093E	22,00
EC 450 RAID	15-	DMX05286F	16,91	FD164E	22,00	DMX05272F	19,96	FD286E	22,00

HM	Año	Referencia	P.V.P.	Referencia	P.V.P.	Referencia	P.V.P.	Referencia	P.V.P.
CRE F 125 X	08-			FD162B	15,60	DMX05002F	16,32	FD278E	22,00
CRE 125 R	03-	DMX05286F	16,91	FD164E	22,00	DMX05002F	16,32	FD278E	22,00
CRF 150 R / R2	08-	DAT05404F	14,67	FD076E	22,00	DMX05002F	16,32	FD278E	22,00
EASY 230 F ENDURO	04-	DMX05286F	16,91	FD164E	22,00	DMX05002F	16,32	FD278E	22,00
CRE 250 F	03-	DMX05286F	16,91	FD164E	22,00	DMX05002F	16,32	FD278E	22,00
CRF 250 R	03-	DMX05286F	16,91	FD164E	22,00	DMX05002F	16,32	FD278E	22,00
CRE 250 X	09-	DMX05286F	16,91	FD164E	22,00	DMX05002F	16,32	FD278E	22,00
CRE 300 X	09-	DMX05286F	16,91	FD164E	22,00	DMX05002F	16,32	FD278E	22,00
CRE 450 F	03-	DMX05286F	16,91	FD164E	22,00	DMX05002F	16,32	FD278E	22,00
CRE 450 R	09-	DMX05286F	16,91	FD164E	22,00	DMX05002F	16,32	FD278E	22,00
CRE 450 X	09-	DMX05286F	16,91	FD164E	22,00	DMX05002F	16,32	FD278E	22,00
CRE F 490 X	07-	DMX05286F	16,91	FD164E	22,00	DMX05002F	16,32	FD278E	22,00
CRE 500 X	09-	DMX05286F	16,91	FD164E	22,00	DMX05002F	16,32	FD278E	22,00

HONDA	Año	Referencia	P.V.P.	Referencia	P.V.P.	Referencia	P.V.P.	Referencia	P.V.P.
CR 80 R	90-96	E64-51866	15,32	FD095E	22,00	E64-51880	16,76	FD093E	22,00
CR 80 R	97-02	DAT05404F	14,67	FD076E	22,00	E64-51880	16,76	FD093E	22,00
CR 85 R	03-07	DAT05404F	14,67	FD076E	22,00	E64-51880	16,76	FD093E	22,00
CR 125 ENDURO	91-	DAT05407F	17,79	FD092E	22,00	E64-51880	16,76	FD093E	22,00
CR 125 R	87-93	DAT05407F	17,79	FD092E	22,00	E64-51880	16,76	FD093E	22,00
CR 125 R	94-01	DMX05286F	16,91	FD164E	22,00	E64-51880	16,76	FD093E	22,00
CR 125 R	02-07	DMX05286F	16,91	FD164E	22,00	DMX05002F	16,32	FD278E	22,00
CRF 150 F	03-06	DMX05286F	16,91	FD164E	22,00				
CRF 150 R	07-	DAT05404F	14,67	FD076E	22,00	DMX05002F	16,32	FD278E	22,00
XLR 200 R	93-99	DMX05286F	16,91	FD164E	22,00	DMX05251M	6,77		
XR 200 R	80-02	DMX05251M	6,77			DMX05251M	6,77		
CRF 230 F	04-	DMX05286F	16,91	FD164E	22,00	DMX05251M	6,77		
CRF 230 L	08-	DMX05286F	16,91	FD164E	22,00	DMX05002F	16,32	FD278E	22,00
CRF 230 M	09-15	DMX05286F	16,91	FD164E	22,00	DMX05002F	16,32	FD278E	22,00



Pastillas freno sinterizadas



Orgánica



Sinterizada

		DELANTERAS				TRASERAS			
		PSYCHIC - EMGO		GALFER		PSYCHIC - EMGO		GALFER	
CR 250 ENDURO	91-	DAT05407F	17,79	FD092E	22,00	E64-51880	16,76	FD093E	22,00
CR 250 R	87-91	DAT05407F	17,79	FD092E	22,00	E64-51880	16,76	FD093E	22,00
CR 250 R	92-01	DMX05286F	16,91	FD164E	22,00	E64-51880	16,76	FD093E	22,00
CR 250 R	02-07	DMX05286F	16,91	FD164E	22,00	DMX05002F	16,32	FD278E	22,00
CRE 250	90-	DAT05407F	17,79	FD092E	22,00	E64-51880	16,76	FD093E	22,00
CRF 250 L	12-15	DMX05286F	16,91	FD164E	22,00	DMX05268F	17,21		
CRF 250 R	04-	DMX05286F	16,91	FD164E	22,00	DMX05002F	16,32	FD278E	22,00
CRF 250 X	04-	DMX05286F	16,91	FD164E	22,00	DMX05002F	16,32	FD278E	22,00
CRF 250 XR LD	13-	DMX05286F	16,91	FD164E	22,00	DMX05002F	16,32	FD278E	22,00
XR 250 R	88-90	DAT05407F	17,79	FD092E	22,00	DMX05268F	17,21		
XR 250 L, R	91-93	DMX05286F	16,91	FD164E	22,00	E64-51880	16,76	FD093E	22,00
XR 250 R	94-02	DMX05286F	16,91	FD164E	22,00	E64-51880	16,76	FD093E	22,00
XR 250 R	03-	DMX05286F	16,91	FD164E	22,00	DMX05002F	16,32	FD278E	22,00
XR 400 R	96-	DMX05286F	16,91	FD164E	22,00	E64-51880	16,76	FD093E	22,00
CRF 450 F	01-14	DMX05286F	16,91	FD164E	22,00	DMX05002F	16,32	FD278E	22,00
CRF 450 R	01-15	DMX05286F	16,91	FD164E	22,00	DMX05002F	16,32	FD278E	22,00
CRF 450 RALLY	13-	DMX05286F	16,91	FD164E	22,00	DMX05002F	16,32	FD278E	22,00
CRF 450 X	04-	DMX05286F	16,91	FD164E	22,00	DMX05002F	16,32	FD278E	22,00
CRF 450 XR LD	13-	DMX05286F	16,91	FD164E	22,00	DMX05002F	16,32	FD278E	22,00
CR 500 R	87-92	DAT05407F	17,79	FD092E	22,00	E64-51880	16,76	FD093E	22,00
CR 500 R	93-00	DMX05286F	16,91	FD164E	22,00	E64-51880	16,76	FD093E	22,00
XR 600 R	87-90	DAT05407F	17,79	FD092E	22,00				
XR 600 R	91-92	DAT05407F	17,79	FD092E	22,00	E64-51880	16,76	FD093E	22,00
XR 600 R	93-	DMX05286F	16,91	FD164E	22,00	E64-51880	16,76	FD093E	22,00
XR 650 L	93-11	DMX05286F	16,91	FD164E	22,00	DMX05268F	17,21		
XR 650 R	00-	DMX05286F	16,91	FD164E	22,00	E64-51880	16,76	FD093E	22,00

HUSABERG									
	Año	Referencia	P.V.P.	Referencia	P.V.P.	Referencia	P.V.P.	Referencia	P.V.P.
125 TE	11-	DMC05554F	16,87	FD138E	22,00	DMX05001F	16,32	FD291E	22,00
250 TE	11-	DMC05554F	16,87	FD138E	22,00	DMX05001F	16,32	FD291E	22,00
250 FE	13-	DMC05554F	16,87	FD138E	22,00	DMX05001F	16,32	FD291E	22,00
300 TE	11-	DMC05554F	16,87	FD138E	22,00	DMX05001F	16,32	FD291E	22,00
350 FC	95-99	DMC05554F	16,87	FD138E	22,00	DMC05553F	17,98	FD165E	22,00
350 FE	95-99	DMC05554F	16,87	FD138E	22,00	DMC05553F	17,98	FD165E	22,00
350 FE	13-	DMC05554F	16,87	FD138E	22,00	DMX05001F	16,32	FD291E	22,00
350 MC	91-92			FD089B	19,70	DAT05560F	18,02	FD075E	22,00
350 MC	94-			FD089B	19,70	DMC05553F	17,98	FD165E	22,00
390 FE	10-	DMC05554F	16,87	FD138E	22,00	DMX05001F	16,32	FD291E	22,00
400 FE	00-	DMC05554F	16,87	FD138E	22,00	DMC05553F	17,98	FD165E	22,00
450 FC	04-	DMC05554F	16,87	FD138E	22,00	DMC05553F	17,98	FD165E	22,00
450 FE	04-	DMC05554F	16,87	FD138E	22,00	DMC05553F	17,98	FD165E	22,00
450 FE	12-	DMC05554F	16,87	FD138E	22,00	DMX05001F	16,32	FD291E	22,00
450 FS	04-04	DMC05655F	19,77			DMC05553F	17,98		
450 FX	10-	DMC05554F	16,87	FD138E	22,00	DMX05001F	16,32	FD291E	22,00
500 Cross	93-93	DMC05554F	16,87	FD138E	22,00	DAT05560F	18,02	FD075E	22,00
500 MC	91-92			FD138E	22,00	DAT05560F	18,02	FD075E	22,00
501 FC	95-99	DMC05554F	16,87	FD138E	22,00	DMC05553F	17,98	FD165E	22,00
501 FE	95-99	DMC05554F	16,87	FD138E	22,00	DMC05553F	17,98	FD165E	22,00
501 FE	13-	DMC05554F	16,87	FD138E	22,00	DMX05001F	16,32	FD291E	22,00
501 MC	89-92			FD089B	19,70	DAT05560F	18,02	FD075E	22,00
501 MC	94-99			FD089B	19,70	DMC05553F	17,98	FD165E	22,00
550 FC	04-	DMC05554F	16,87	FD138E	22,00	DMC05553F	17,98	FD165E	22,00
550 FE	04-	DMC05554F	16,87	FD138E	22,00	DMC05553F	17,98	FD165E	22,00
570 FE	09-	DMC05554F	16,87	FD138E	22,00	DMX05001F	16,32	FD291E	22,00
600 FC	95-99	DMC05554F	16,87	FD138E	22,00	DMC05553F	17,98	FD165E	22,00
600 FE	95-99	DMC05554F	16,87	FD138E	22,00	DMC05553F	17,98	FD165E	22,00
650 FC	04-	DMC05554F	16,87	FD138E	22,00	DMC05553F	17,98	FD165E	22,00
650 FE	04-	DMC05554F	16,87	FD138E	22,00	DMC05553F	17,98	FD165E	22,00
650 FS	03-03	DMC05655F	19,77			DMC05553F	17,98		

HUSQVARNA	DELANTERAS				TRASERAS				
	PSYCHIC - EMGO	GALFER		PSYCHIC - EMGO	GALFER				
Año	Referencia	P.V.P.	Referencia	P.V.P.	Referencia	P.V.P.	Referencia	P.V.P.	
50 CR	11-		FD230E	19,40			FD230E	19,40	
50 CR Senior Pro	05-		FD224B	18,50			FD230E	19,40	
65 CR	11-		FD265E	20,60			FD441E	22,00	
85 TC 17/14	14-		FD458B	17,40			FD441E	22,00	
85 TC 19/16	14-		FD458B	17,40			FD441E	22,00	
100 TE	05-		FD224B	18,50			FD230E	19,40	
125 CR	91-91		FD089B	19,70	DAT05560F	18,02	FD075E	22,00	
125 CR	92-94	DAT05561F		15,82					
125 CR	94-99	DMC05554F	16,87	FD138E	22,00	DMC05553F	17,98	FD165E	22,00
125 CR	93-99	E64-71971	16,45	FD086E	22,00	DAT05560F	18,02	FD075E	22,00
125 CR	04-05	DMC05554F	16,87	FD138E	22,00	DMX05001F	16,32	FD291E	22,00
125 SM S	00-	DMC05554F	16,87	FD138E	22,00	DMC05553F	17,98	FD165E	22,00
125 SM S 4t	11-	DMC05554F	16,87	FD138E	22,00	DMC05553F	17,98	FD165E	22,00
125 TC	14-	DMC05554F	16,87	FD138E	22,00	DMX05001F	16,32	FD291E	22,00
125 TE 4t	11-13	DMC05554F	16,87	FD138E	22,00	DMC05553F	17,98	FD165E	22,00
125 TE	14-	DMC05554F	16,87	FD138E	22,00	DMX05001F	16,32	FD291E	22,00
125 WR	93-99	E64-71971	16,45	FD086E	22,00	DAT05560F	18,02	FD075E	22,00
125 WR	94-99	DMC05554F	16,87	FD138E	22,00	DMC05553F	17,98	FD165E	22,00
125 WR	06-	DMC05554F	16,87	FD138E	22,00	DMX05001F	16,32	FD291E	22,00
125 WRE	94-	DMC05554F	16,87	FD138E	22,00	DMC05553F	17,98	FD165E	22,00
125 WXE	07-		FD133B	15,50	E64-51880	16,76	FD093E	22,00	
250 CR	94-03	DMC05554F	16,87	FD138E	22,00	DMC05553F	17,98	FD165E	22,00
250 CR	04-05	DMC05554F	16,87	FD138E	22,00	DMX05001F	16,32	FD291E	22,00
250 CR, WR	93-99	E64-71971	16,45	FD086E	22,00	DAT05560F	18,02	FD075E	22,00
250 FC	14-	DMC05554F	16,87	FD138E	22,00	DMX05001F	16,32	FD291E	22,00
250 FE	14-	DMC05554F	16,87	FD138E	22,00	DMX05001F	16,32	FD291E	22,00
250 TC	04-16	DMC05554F	16,87	FD138E	22,00	DMX05001F	16,32	FD291E	22,00
250 TE	05-14	DMC05554F	16,87	FD138E	22,00	DMX05001F	16,32	FD291E	22,00
250 TE-R	13-13	DMC05554F	16,87	FD138E	22,00	DMX05001F	16,32	FD291E	22,00
250 WR	94-00	DMC05554F	16,87	FD138E	22,00	DMC05553F	17,98	FD165E	22,00
300 TE	14-	DMC05554F	16,87	FD138E	22,00	DMX05001F	16,32	FD291E	22,00
300 WR	09-	DMC05554F	16,87	FD138E	22,00	DMX05001F	16,32	FD291E	22,00
310 TE	09-	DMC05554F	16,87	FD138E	22,00	DMX05001F	16,32	FD291E	22,00
350 FC	14-	DMC05554F	16,87	FD138E	22,00	DMX05001F	16,32	FD291E	22,00
350 FE	14-	DMC05554F	16,87	FD138E	22,00	DMX05001F	16,32	FD291E	22,00
350 TE	94-99	DMC05554F	16,87	FD138E	22,00	DMC05553F	17,98	FD165E	22,00
350 TE 4t	91-94		FD089B	19,70	DAT05560F	18,02	FD075E	22,00	
360 CR	92-94		FD089B	19,70	DAT05560F	18,02	FD075E	22,00	
360 CR	94-99	DMC05554F	16,87	FD138E	22,00	DMC05553F	17,98	FD165E	22,00
360 WR	92-94	E64-71971	16,45	FD086E	22,00	DAT05404F	14,67	FD076E	22,00
360 WR	94-00	DMC05554F	16,87	FD138E	22,00	DMC05553F	17,98	FD165E	22,00
401 Svartpilen	15-		FD450B	16,70					
410 TE	94-00	DMC05554F	16,87	FD138E	22,00	DMC05553F	17,98	FD165E	22,00
410 TE/E	00-02	DMC05554F	16,87	FD138E	22,00	DMC05553F	17,98		
449 TE	11-	DMC05554F	16,87	FD138E	22,00	DMX05001F	16,32	FD291E	22,00
449 TC	11-13	DMC05554F	16,87	FD138E	22,00	DMX05001F	16,32		
450 FE	14-	DMC05554F	16,87	FD138E	22,00	DMX05001F	16,32	FD291E	22,00
450 FC	14-	DMC05554F	16,87	FD138E	22,00	DMX05001F	16,32	FD291E	22,00
450 TC	05-	DMC05554F	16,87	FD138E	22,00	DMX05001F	16,32	FD291E	22,00
450 TE	05-	DMC05554F	16,87	FD138E	22,00	DMX05001F	16,32	FD291E	22,00
449 TC	11-	DMC05554F	16,87	FD138E	22,00	DMX05001F	16,32	FD291E	22,00
449 TE	11-	DMC05554F	16,87	FD138E	22,00	DMX05001F	16,32	FD291E	22,00
450 SM R	01-04	DMC05655F	19,77			DMC05553F	17,98		
501 FE	14-	DMC05554F	16,87	FD138E	22,00	DMX05001F	16,32	FD291E	22,00
510 TC	04-05	DMC05554F	16,87	FD138E	22,00	DMX05001F	16,32	FD291E	22,00
510 TE	90-94		FD089B	19,70	DAT05560F	18,02	FD075E	22,00	
510 TE	95-04	DMC05554F	16,87	FD138E	22,00	DMC05553F	17,98	FD165E	22,00
510 TE	05-	DMC05554F	16,87	FD138E	22,00	DMX05001F	16,32	FD291E	22,00
511 TE	11-	DMC05554F	16,87	FD138E	22,00	DMX05001F	16,32	FD291E	22,00
570 TE	00-	DMC05554F	16,87	FD138E	22,00	DMC05553F	17,98	FD165E	22,00
570 SM R	01-04	DMC05655F	19,77			DMC05553F	17,98		
610 SM R	00-04	DMC05655F	19,77			DMC05553F	17,98		
610 TC	91-94		FD089B	19,70	DAT05560F	18,02	FD075E	22,00	
610 TC	94-00	DMC05554F	16,87	FD138E	22,00	DMC05553F	17,98	FD165E	22,00

		DELANTERAS				TRASERAS			
		PSYCHIC - EMGO		GALFER		PSYCHIC - EMGO		GALFER	
610 TE 4t	91-94			FD089B	19,70	DAT05560F	18,02	FD075E	22,00
610 TE	92-94	E64-71971	16,45	FD086E	22,00	E64-51866	15,32	FD095E	22,00
610 TE	94-	DMC05554F	16,87	FD138E	22,00	DMC05553F	17,98	FD165E	22,00
630 SM R	06-12	DMC05655F	19,77			DMX05001F	16,32		
630 TE	10-	DMC05554F	16,87	FD138E	22,00	DMC05553F	17,98	FD165E	22,00
KAWASAKI									
	Año	Referencia	P.V.P.	Referencia	P.V.P.	Referencia	P.V.P.	Referencia	P.V.P.
KX 60	94-	E64-71971	16,45	FD086E	22,00				
KX 65	00-14			FD254E	22,00	E64-51866	15,32	FD095E	22,00
KX 80	93-96	DMC05264F	19,86	FD091E	22,00	E64-81372	16,96	FD114E	22,00
KX 80 R7 KX 80-II	97-99	DMX05265F	19,86	FD204E	22,00	DAT05404F	14,67	FD076E	22,00
KX 85	00-	DMX05265F	19,86	FD204E	22,00	DAT05404F	14,67	FD076E	22,00
KX 100	88-04			FD094E	22,00	DAT05404F	14,67	FD076E	22,00
KL 125 ENDURO	03-	DMX05286F	16,91	FD164E	22,00	DMX05272F	19,96	FD286E	22,00
KX 125	89-94	E64-71971	16,45	FD086E	22,00	E64-81372	16,96	FD114E	22,00
KX 125	95-05	DMX05286F	16,91	FD164E	22,00	E64-51880	16,76	FD093E	22,00
KLX 140 L	08-	E64-71971	16,45	FD086E	22,00	E64-51866	15,32	FD095E	22,00
KDX 200 SR	90-	E64-71971	16,45	FD086E	22,00	E64-81372	16,96	FD114E	22,00
KDX 220	99-	DMX05286F	16,91	FD164E	22,00	E64-81372	16,96	FD114E	22,00
KDX 250 R	92-	E64-71971	16,45	FD086E	22,00	E64-81372	16,96	FD114E	22,00
KLX 250	09-	E64-71971	16,45	FD086E	22,00	E64-51880	16,76	FD093E	22,00
KLX 250 R	92-	E64-71971	16,45	FD086E	22,00	E64-81372	16,96	FD114E	22,00
KLX 250 S	05-07	DMX05286F	16,91	FD164E	22,00	E64-51880	16,76	FD093E	22,00
KLX 250 S	08-	DMX05286F	16,91	FD164E	22,00	DMX05272F	19,96	FD286E	22,00
KLX 250 SF	09-	E64-71971	16,45	FD086E	22,00	E64-51880	16,76	FD093E	22,00
KX 250	89-93	E64-71971	16,45	FD086E	22,00	E64-81372	16,96	FD114E	22,00
KX 250	94-94	DMX05286F	16,91	FD164E	22,00	E64-81372	16,96	FD114E	22,00
KX 250	95-03	DMX05286F	16,91	FD164E	22,00	E64-51880	16,76	FD093E	22,00
KX 250	04-	DMX05286F	16,91	FD164E	22,00	DMX05272F	19,96	FD286E	22,00
KX 250 F	04-	DMX05286F	16,91	FD164E	22,00	DMX05272F	19,96	FD286E	22,00
KXE 250 F	03-	DMX05286F	16,91	FD164E	22,00	DMX05272F	19,96	FD286E	22,00
KLX 300 R	96-	DMX05286F	16,91	FD164E	22,00	E64-51880	16,76	FD093E	22,00
KLX 400 R	03-	DMX05286F	16,91	FD164E	22,00	E64-51880	16,76	FD093E	22,00
KLX 450 R	07-	DMX05286F	16,91	FD164E	22,00	DMX05272F	19,96	FD286E	22,00
KX 450 F	06-	DMX05286F	16,91	FD164E	22,00	DMX05272F	19,96	FD286E	22,00
KXE 450 F	06-	DMX05286F	16,91	FD164E	22,00	DMX05272F	19,96	FD286E	22,00
KX 500	89-93	E64-71971	16,45	FD086E	22,00	E64-81372	16,96	FD114E	22,00
KX 500	94-04	DMX05286F	16,91	FD164E	22,00	E64-81372	16,96	FD114E	22,00
KX 500	95-	DMX05286F	16,91	FD164E	22,00	E64-51880	16,76	FD093E	22,00
KLX 650 R	93-	DMX05286F	16,91	FD164E	22,00	E64-81372	16,96	FD114E	22,00
KLX 650 S	93-	DMX05286F	16,91	FD164E	22,00	E64-81372	16,96	FD114E	22,00
KTM									
	Año	Referencia	P.V.P.	Referencia	P.V.P.	Referencia	P.V.P.	Referencia	P.V.P.
50 Go	95-			FD084B	16,20				
50 LC Pro Senior	04-			FD230E	19,40			FD230E	19,40
50 SX	06-			FD230E	19,40			FD230E	19,40
EXC 50	99-			FD133B	15,50	DMP05080F	16,30	FD065B	9,90
60 SX	99-	DMP05080F	16,30	FD065B	9,90				
65 SX	00-01	DMP05080F	16,30	FD065B	9,90			FD048B	14,50
65 SX	02-03			FD265E	20,60			FD048B	14,50
65 SX	04-08			FD265E	20,60			FD230E	19,40
65 SX	09-			FD265E	20,60			FD265E	20,60
65 XC	08-			FD265E	20,60			FD230E	19,40
80 MX	92-01			FD012B	13,00				
85 SX	03-06			FD265E	20,60			FD265E	20,60
85 SX	07-10			FD265E	20,60			FD265E	20,60
85 SX	11-11			FD265E	20,60			FD441E	22,00
85 SX 17/14	12-			FD458B	17,40			FD441E	22,00
85 SX 19/16	13-			FD458B	17,40			FD441E	22,00
105 SX (USA)	04-06			FD265E	20,60			FD265E	20,60
105 XC	07-			FD265E	20,60			FD265E	20,60
125 Enduro	88-91			FD074B	18,00			FD074B	18,00
125 Enduro	92-92			FD128B	19,50	DAT05560F	18,02	FD075E	22,00
125 Enduro	93-	DMC05554F	16,87	FD138E	22,00	DAT05560F	18,02	FD075E	22,00
125 EGS	95-03	DMC05554F	16,87	FD138E	22,00	DMC05553F	17,98	FD165E	22,00
125 EXC	95-03	DMC05554F	16,87	FD138E	22,00	DMC05553F	17,98	FD165E	22,00
125 EXC	04-	DMC05554F	16,87	FD138E	22,00	DMX05001F	16,32	FD291E	22,00

RUEDAS Y NEUMÁTICOS

MOTOR

 ADMISIÓN / ESCAPE
REFRIGERACIÓN

ELÉCTRICO

SUSPENSIÓN / DIRECCIÓN

FRENOS

TRANSMISIÓN

CONTROLES Y MANDOS

CHASIS

ACCESORIOS

		DELANTERAS				TRASERAS			
		PSYCHIC - EMGO		GALFER		PSYCHIC - EMGO		GALFER	
125 GS	89-90			FD074B	18,00			FD074B	18,00
125 GS	91-92			FD128B	19,50	DAT05560F	18,02	FD075E	22,00
125 GS	93-93	DMC05554F	16,87	FD138E	22,00	DAT05560F	18,02	FD075E	22,00
125 GS	94-94	DMC05554F	16,87	FD138E	22,00	DMC05553F	17,98	FD165E	22,00
125 MX	89-91	DAT05560F	18,02	FD075E	22,00	DAT05560F	18,02	FD075E	22,00
125 MX	92-95	DMC05554F	16,87	FD138E	22,00	DAT05560F	18,02	FD075E	22,00
125 RS	89-			FD082B	22,60				
125 SX	93-93	DMC05554F	16,87	FD138E	22,00	DAT05560F	18,02	FD075E	22,00
125 SX	94-03	DMC05554F	16,87	FD138E	22,00	DMC05553F	17,98	FD165E	22,00
125 SX	04-	DMC05554F	16,87	FD138E	22,00	DMX05001F	16,32	FD291E	22,00
144 SX	08-	DMC05554F	16,87	FD138E	22,00	DMX05001F	16,32	FD291E	22,00
150 SX 17/14	15-			FD458B	17,40			FD441E	22,00
150 SX 19/16	15			FD458B	17,40			FD441E	22,00
150 XC	10-	DMC05554F	16,87	FD138E	22,00	DMX05001F	16,32	FD291E	22,00
200 EXC	98-03	DMC05554F	16,87	FD138E	22,00	DMC05553F	17,98	FD165E	22,00
200 EXC	04-	DMC05554F	16,87	FD138E	22,00	DMX05001F	16,32	FD291E	22,00
200 EGS	99-02	DMC05554F	16,87	FD138E	22,00	DMC05553F	17,98	FD165E	22,00
200 SX	03-03	DMC05554F	16,87	FD138E	22,00	DMC05553F	17,98	FD165E	22,00
200 SX	04-	DMC05554F	16,87	FD138E	22,00	DMX05001F	16,32	FD291E	22,00
250 EGS	93-93	DMC05554F	16,87	FD138E	22,00	DAT05560F	18,02	FD075E	22,00
250 EGS	94-	DMC05554F	16,87	FD138E	22,00	DMC05553F	17,98	FD165E	22,00
250 Enduro	88-91			FD074B	18,00			FD074B	18,00
250 Enduro	92-92			FD128B	19,50	DAT05560F	18,02	FD075E	22,00
250 Enduro	93-	DMC05554F	16,87	FD138E	22,00	DAT05560F	18,02	FD075E	22,00
250 EXC	93-93	DMC05554F	16,87	FD138E	22,00	DAT05560F	18,02	FD075E	22,00
250 EXC	94-03	DMC05554F	16,87	FD138E	22,00	DMC05553F	17,98	FD165E	22,00
250 EXC / 4t	04-	DMC05554F	16,87	FD138E	22,00	DMX05001F	16,32	FD291E	22,00
250 F	06-	DMC05554F	16,87	FD138E	22,00	DMX05001F	16,32	FD291E	22,00
250 Freeride	13-			FD458B	17,40			FD441E	22,00
250 GS	89-90			FD074B	18,00			FD074B	18,00
250 GS	91-92			FD128B	19,50	DAT05560F	18,02	FD075E	22,00
250 GS	93-93	DMC05554F	16,87	FD138E	22,00	DAT05560F	18,02	FD075E	22,00
250 GS	94-	DMC05554F	16,87	FD138E	22,00	DMC05553F	17,98	FD165E	22,00
250 MX	89-91	DAT05560F	18,02	FD075E	22,00	DAT05560F	18,02	FD075E	22,00
250 MX	92-92	DMC05554F	16,87	FD138E	22,00	DAT05560F	18,02	FD075E	22,00
250 MX	03-	DMC05554F	16,87	FD138E	22,00	DMC05553F	17,98	FD165E	22,00
250 SX	93-93	DMC05554F	16,87	FD138E	22,00	DAT05560F	18,02	FD075E	22,00
250 SX	94-02	DMC05554F	16,87	FD138E	22,00	DMC05553F	17,98	FD165E	22,00
250 SX	03-	DMC05554F	16,87	FD138E	22,00	DMX05001F	16,32	FD291E	22,00
250 SX F	15-	DMC05554F	16,87	FD138E	22,00	DMX05001F	16,32	FD291E	22,00
250 XC / F / W	06-	DMC05554F	16,87	FD138E	22,00	DMX05001F	16,32	FD291E	22,00
300 Enduro	92-92			FD128B	19,50	DAT05560F	18,02	FD075E	22,00
300 Enduro	93-	DMC05554F	16,87	FD138E	22,00	DAT05560F	18,02	FD075E	22,00
300 EGS	93-03	DMC05554F	16,87	FD138E	22,00	DAT05560F	18,02	FD075E	22,00
300 EXC	03-03	DMC05554F	16,87	FD138E	22,00	DMC05553F	17,98	FD165E	22,00
300 EXC	04-	DMC05554F	16,87	FD138E	22,00	DMX05001F	16,32	FD291E	22,00
300 EXC - E	08-	DMC05554F	16,87	FD138E	22,00	DMX05001F	16,32	FD291E	22,00
300 GS	91-			FD128B	19,50	DAT05560F	18,02	FD075E	22,00
300 MXC	04-	DMC05554F	16,87	FD138E	22,00	DMX05001F	16,32	FD291E	22,00
300 SX	93-03	DMC05554F	16,87	FD138E	22,00	DAT05560F	18,02	FD075E	22,00
300 XC	93-03	DMC05554F	16,87			DAT05560F	18,02		
300 XC / W	06-	DMC05554F	16,87	FD138E	22,00	DMX05001F	16,32	FD291E	22,00
350 ECX F	12-	DMC05554F	16,87	FD138E	22,00	DMX05001F	16,32	FD291E	22,00
350 EXC LC4	94-	DMC05554F	16,87	FD138E	22,00	DMC05553F	17,98	FD165E	22,00
350 Enduro	88-			FD074B	18,00			FD074B	18,00
350 Freeride	12-			FD458B	17,40			FD441E	22,00
350 MX	91-91	DAT05560F	18,02	FD075E	22,00	DAT05560F	18,02	FD075E	22,00
350 MX	92-	DMC05554F	16,87	FD138E	22,00	DAT05560F	18,02	FD075E	22,00
350 SX Factory	10-	DMC05554F	16,87	FD138E	22,00	DMX05001F	16,32	FD291E	22,00
350 SX F	11-	DMC05554F	16,87	FD138E	22,00	DMX05001F	16,32	FD291E	22,00
350 XC F	11-	DMC05554F	16,87	FD138E	22,00	DMX05001F	16,32	FD291E	22,00
400 EXC	04-	DMC05554F	16,87	FD138E	22,00	DMX05001F	16,32	FD291E	22,00
400 LC4 EGS	94-96	DMC05554F	16,87	FD138E	22,00	DMC05553F	17,98	FD165E	22,00
440 SX	94-	DMC05554F	16,87	FD138E	22,00	DMC05553F	17,98	FD165E	22,00
450 EXC	03-03	DMC05554F	16,87	FD138E	22,00	DMC05553F	17,98	FD165E	22,00
450 EXC	04-	DMC05554F	16,87	FD138E	22,00	DMX05001F	16,32	FD291E	22,00
450 EXC - R	08-	DMC05554F	16,87	FD138E	22,00	DMX05001F	16,32	FD291E	22,00

		DELANTERAS				TRASERAS			
		PSYCHIC - EMGO		GALFER		PSYCHIC - EMGO		GALFER	
450 MXC	04-	DMC05554F	16,87	FD138E	22,00	DMX05001F	16,32	FD291E	22,00
450 Rally	11-	DMC05554F	16,87	FD138E	22,00	DMX05001F	16,32	FD291E	22,00
450 SX	03-	DMC05554F	16,87	FD138E	22,00	DMX05001F	16,32	FD291E	22,00
450 SXF	07-	DMC05554F	16,87	FD138E	22,00	DMX05001F	16,32	FD291E	22,00
450 XC	06-	DMC05554F	16,87	FD138E	22,00	DMX05001F	16,32	FD291E	22,00
450 XC Six Days	10-	DMC05554F	16,87	FD138E	22,00	DMX05001F	16,32	FD291E	22,00
500 EXC 4t	12-14	DMC05554F	16,87			DMX05001F	16,32		
500 EXC	14-	DMC05554F	16,87	FD138E	22,00	DMX05001F	16,32	FD291E	22,00
500 MX	92-	DMC05554F	16,87	FD138E	22,00	DAT05560F	18,02	FD075E	22,00
500 SX	93-	DMC05554F	16,87	FD138E	22,00	DAT05560F	18,02	FD075E	22,00
505 SX	07-	DMC05554F	16,87	FD138E	22,00	DMX05001F	16,32	FD291E	22,00
505 SXF	07-09	DMC05554F	16,87			DMX05001F	16,32		
525 EXC	03-03	DMC05554F	16,87	FD138E	22,00	DMC05553F	17,98	FD165E	22,00
525 EXC	04-	DMC05554F	16,87	FD138E	22,00	DMX05001F	16,32	FD291E	22,00
525 MXC	04-	DMC05554F	16,87	FD138E	22,00	DMX05001F	16,32	FD291E	22,00
525 SX	03-03	DMC05554F	16,87	FD138E	22,00	DMC05553F	17,98	FD165E	22,00
525 SX	04-	DMC05554F	16,87	FD138E	22,00	DMX05001F	16,32	FD291E	22,00
530 EXC-R	08-	DMC05554F	16,87	FD138E	22,00	DMX05001F	16,32	FD291E	22,00
530 XC / W	08-	DMC05554F	16,87	FD138E	22,00	DMX05001F	16,32	FD291E	22,00
530 XC Six days	10-	DMC05554F	16,87	FD138E	22,00	DMX05001F	16,32	FD291E	22,00
540 SXC	99-	DMC05554F	16,87	FD138E	22,00	DMC05553F	17,98	FD165E	22,00
550 MG,XC	94-	DMC05554F	16,87	FD138E	22,00	DMC05553F	17,98	FD165E	22,00
600 4t Gara	91-92			FD128B	19,50	DAT05560F	18,02	FD075E	22,00
600 4t GS	93-93	DMC05554F	16,87	FD138E	22,00	DAT05560F	18,02	FD075E	22,00
600 4t GS	94-	DMC05554F	16,87	FD138E	22,00	DMC05553F	17,98	FD165E	22,00
600 MX LC4	90-	DAT05560F	18,02	FD075E	22,00	DAT05560F	18,02	FD075E	22,00
600 Prolever	87-			FD085B	22,00			FD085B	22,00
620 LC4 EXC, EGS, SX	94-	DMC05554F	16,87	FD138E	22,00	DMC05553F	17,98	FD165E	22,00
625 EXC	03-	DMC05554F	16,87	FD138E	22,00	DMC05553F	17,98	FD165E	22,00
640 LC4 Enduro	99-	DMC05554F	16,87	FD138E	22,00	DMC05553F	17,98	FD165E	22,00
690 Enduro	08-			FD172ST	25,90	DMC05553F	17,98	FD165E	22,00
690 Enduro R	09-			FD172ST	25,90	DMC05553F	17,98	FD165E	22,00
950 Adventure S	03-			FD172ST	25,90	DMC05554F	16,87	FD138E	22,00
950 R Super Enduro	06-			FD172ST	25,90	DMC05554F	16,87	FD138E	22,00
990 R Super Enduro	06-			FD172ST	25,90	DMC05554F	16,87	FD138E	22,00
POLINI	Año	Referencia	P.V.P.	Referencia	P.V.P.	Referencia	P.V.P.	Referencia	P.V.P.
65 XP R Minicross	08-			FD224B	18,50			FD224B	18,50
100 XP 4t Cross	08-			FD224B	18,50			FD224B	18,50
100 XP 4t Racing Cross	08-			FD224B	18,50			FD224B	18,50
125 XP 4 Off Road	08-			FD224B	18,50			FD224B	18,50
RIEJU	Año	Referencia	P.V.P.	Referencia	P.V.P.	Referencia	P.V.P.	Referencia	P.V.P.
250 Marathon	09-	DMC05554F	16,87	FD138E	22,00	DMX05001F	16,32	FD291E	22,00
250 MRX	06-	DMX05286F	16,91	FD164E	22,00	E64-51880	16,76	FD093E	22,00
450 Marathon 450	09-	DMC05554F	16,87	FD138E	22,00	DMX05001F	16,32	FD291E	22,00
450 MRX	05-	DMX05286F	16,91	FD164E	22,00	E64-51880	16,76	FD093E	22,00
SCORPA	Año	Referencia	P.V.P.	Referencia	P.V.P.	Referencia	P.V.P.	Referencia	P.V.P.
125 T-Ride F	10-			FD409E	22,00			FD270B	18,00
250 Enduro 2.5 i	06-	DMX05286F	16,91	FD164E	22,00	E64-51880	16,76	FD093E	22,00
450 Enduro 4.5 i	06-	DMX05286F	16,91	FD164E	22,00	E64-51880	16,76	FD093E	22,00
510 Enduro 5.1 i	06-	DMX05286F	16,91	FD164E	22,00	E64-51880	16,76	FD093E	22,00
SHERCO	Año	Referencia	P.V.P.	Referencia	P.V.P.	Referencia	P.V.P.	Referencia	P.V.P.
125 SE 1.25 F	10-			FD162B	15,60			FD270B	18,00
250 2.5 if	09-	DMC05554F	16,87	FD138E	22,00	E64-51880	16,76	FD093E	22,00
250 SE 2.5i	12-13	DMC05554F	16,87	FD138E	22,00	DMX05001F	16,32	FD291E	22,00
250 SX 2.5 F	10-	DMC05554F	16,87	FD138E	22,00	DMX05272F	19,96	FD286E	22,00
250 SE Fork Sachs	14-	DMC05554F	16,87	FD138E	22,00	DMX05001F	16,32	FD291E	22,00
250 SE Fork WP	14-	DMC05554F	16,87	FD138E	22,00	DMX05001F	16,32	FD291E	22,00
250 SE-R Fork Sachs	14-	DMC05554F	16,87	FD138E	22,00	DMX05001F	16,32	FD291E	22,00
250 SE-R Fork WP	14-	DMC05554F	16,87	FD138E	22,00	DMX05001F	16,32	FD291E	22,00
250 SEF Fork Sachs	14-	DMC05554F	16,87	FD138E	22,00	DMX05001F	16,32	FD291E	22,00
250 SEF Fork WP	14-	DMC05554F	16,87	FD138E	22,00	DMX05001F	16,32	FD291E	22,00
250 SEF-R Fork Sachs	14-	DMC05554F	16,87	FD138E	22,00	DMX05001F	16,32	FD291E	22,00
250 SEF-R Fork WP	14-	DMC05554F	16,87	FD138E	22,00	DMX05001F	16,32	FD291E	22,00
290 X-Ride	13-14	DAT05560F	18,02			DAT05560F	18,02		

		DELANTERAS				TRASERAS			
		PSYCHIC - EMGO		GALFER		PSYCHIC - EMGO		GALFER	
300 SE 3.0	10-11	DMC05554F	16,87	FD138E	22,00	DMX05272F	19,96	FD286E	22,00
300 SE 3.0i	12-13	DMC05554F	16,87	FD138E	22,00	DMX05001F	16,32	FD291E	22,00
300 SE Fork Sachs	14-	DMC05554F	16,87	FD138E	22,00	DMX05001F	16,32	FD291E	22,00
300 SE Fork WP	14-	DMC05554F	16,87	FD138E	22,00	DMX05001F	16,32	FD291E	22,00
300 SE-R Fork Sachs	14-	DMC05554F	16,87	FD138E	22,00	DMX05001F	16,32	FD291E	22,00
300 SE-R Fork WP	14-	DMC05554F	16,87	FD138E	22,00	DMX05001F	16,32	FD291E	22,00
300 SEF Fork Sachs	14-	DMC05554F	16,87	FD138E	22,00	DMX05001F	16,32	FD291E	22,00
300 SEF Fork WP	14-	DMC05554F	16,87	FD138E	22,00	DMX05001F	16,32	FD291E	22,00
300 SEF-R Fork Sachs	14-	DMC05554F	16,87	FD138E	22,00	DMX05001F	16,32	FD291E	22,00
300 SEF-R Fork WP	14-	DMC05554F	16,87	FD138E	22,00	DMX05001F	16,32	FD291E	22,00
450 4.5 4t	04-08	DMC05554F	16,87	FD138E	22,00	DMX05272F	19,96	FD286E	22,00
450 4.5 if	09-	DMC05554F	16,87	FD138E	22,00	E64-51880	16,76	FD093E	22,00
450 SEF Fork Sachs	15-	DMC05554F	16,87	FD138E	22,00	DMX05001F	16,32	FD291E	22,00
450 SEF Fork WP	15-	DMC05554F	16,87	FD138E	22,00	DMX05001F	16,32	FD291E	22,00
450 SEF-R Fork Sachs	15-	DMC05554F	16,87	FD138E	22,00	DMX05001F	16,32	FD291E	22,00
450 SEF-R Fork WP	15-	DMC05554F	16,87	FD138E	22,00	DMX05001F	16,32	FD291E	22,00
450 SE 4.5i	12-13	DMC05554F	16,87	FD138E	22,00	DMX05001F	16,32	FD291E	22,00
510 5.1 4t	06-08	DMC05554F	16,87	FD138E	22,00	DMX05272F	19,96	FD286E	22,00
510 5.1 if	09-	DMC05554F	16,87	FD138E	22,00	E64-51880	16,76	FD093E	22,00
510 SE 5.1i	12-13	DMC05554F	16,87	FD138E	22,00	DMX05001F	16,32	FD291E	22,00
SUZUKI	Año	Referencia	P.V.P.	Referencia	P.V.P.	Referencia	P.V.P.	Referencia	P.V.P.
RM 65	03-			FD254E	22,00	E64-51866	15,32	FD095E	22,00
RM 80	90-95			FD094E	22,00			FD094E	22,00
RM 80	96-02			FD177B	23,00			FD094E	22,00
RM 85 / L	03-04			FD177B	23,00			FD094E	22,00
RM 85 / L	05-	DMX05265F	19,86	FD204E	22,00			FD362E	22,00
RM 125	89-95	E64-71971	16,45	FD086E	22,00	E64-81372	16,96	FD114E	22,00
RM 125	96-03	DMX05286F	16,91	FD164E	22,00	E64-51880	16,76	FD093E	22,00
RM 125	04-09	DMX05286F	16,91	FD164E	22,00	DMX05272F	19,96	FD286E	22,00
DR 250 S	90-00	E64-71971	16,45	FD086E	22,00	E64-81372	16,96	FD114E	22,00
DR-Z 250 E	01-	DMX05286F	16,91	FD164E	22,00	E64-51880	16,76	FD093E	22,00
RM 250	89-95	E64-71971	16,45	FD086E	22,00	E64-81372	16,96	FD114E	22,00
RM 250	96-12	DMX05286F	16,91	FD164E	22,00	E64-51880	16,76	FD093E	22,00
RM 250 Z	04-06	DMX05286F	16,91	FD164E	22,00	DMX05272F	19,96	FD286E	22,00
RMX S	92-94	E64-71971	16,45	FD086E	22,00	E64-81372	16,96	FD114E	22,00
RMX 250	95-	E64-71971	16,45	FD086E	22,00	E64-81372	16,96	FD114E	22,00
DR 350 S	90-92	E64-71971	16,45	FD086E	22,00	E64-81372	16,96	FD114E	22,00
DR 350 S, SH	93-93	E64-71971	16,45	FD086E	22,00	E64-81372	16,96	FD114E	22,00
DR 350 SE	94-	E64-71971	16,45	FD086E	22,00	E64-81372	16,96	FD114E	22,00
DR-Z 400 E	00-	DMX05286F	16,91	FD164E	22,00	E64-51880	16,76	FD093E	22,00
DR-Z 400 S	00-	DMX05286F	16,91	FD164E	22,00	E64-51880	16,76	FD093E	22,00
RM 450 Z	05-	DMX05286F	16,91	FD164E	22,00	DMX05272F	19,96	FD286E	22,00
RMX 450 Z	10-	DMX05286F	16,91	FD164E	22,00	DMX05272F	19,96	FD286E	22,00
SWM	Año	Referencia	P.V.P.	Referencia	P.V.P.	Referencia	P.V.P.	Referencia	P.V.P.
RS 125 R	16-	DMC05554F	16,87	FD138E	22,00	DMX05001F	16,32	FD291E	22,00
MC 250 S	16-	DMC05554F	16,87	FD138E	22,00	DMX05001F	16,32	FD291E	22,00
RS 300 R	16-	DMC05554F	16,87	FD138E	22,00	DMX05001F	16,32	FD291E	22,00
RS 340 S	16-	DMC05554F	16,87	FD138E	22,00	DMX05001F	16,32	FD291E	22,00
TM	Año	Referencia	P.V.P.	Referencia	P.V.P.	Referencia	P.V.P.	Referencia	P.V.P.
80 GS, MC	90-92			FD089B	19,70	DAT05560F	18,02	FD075E	22,00
80 GS, MC	93-	DMC05554F	16,87	FD138E	22,00	DMC05553F	17,98	FD165E	22,00
80 Junior	05-	DMC05554F	16,87	FD138E	22,00	E64-51880	16,76	FD093E	22,00
85 Junior	05-	DMC05554F	16,87	FD138E	22,00	E64-51880	16,76	FD093E	22,00
85 MX	01-04	DMC05554F	16,87	FD138E	22,00	DMC05553F	17,98	FD165E	22,00
85 MX	05-12	DMC05554F	16,87	FD138E	22,00	DMX05272F	19,96	FD286E	22,00
85 MX	13-	DMX05002F	16,32	FD278E	22,00	DMX05002F	16,32	FD278E	22,00
100 Junior	05-	DMC05554F	16,87	FD138E	22,00	E64-51880	16,76	FD093E	22,00
125 Cross	00-	DMC05554F	16,87	FD138E	22,00	DMC05553F	17,98	FD165E	22,00
125 Enduro/MX	00-	DMC05554F	16,87	FD138E	22,00	DMC05553F	17,98	FD165E	22,00
125 GS, MC	90-92			FD089B	19,70	DAT05560F	18,02	FD075E	22,00
125 GS, MC	93-	DMC05554F	16,87	FD138E	22,00	DMC05553F	17,98	FD165E	22,00
125 EN	00-04	DMC05554F	16,87			DMC05553F	17,98		
125 EN	04-	DMC05554F	16,87	FD138E	22,00	DMX05272F	19,96	FD286E	22,00
125 MX	00-04	DMC05554F	16,87	FD138E	22,00	DMX05272F	19,96	FD286E	22,00
125 MX	05-	DMC05554F	16,87	FD138E	22,00	DMX05272F	19,96	FD286E	22,00
144 EN	14-14	DMC05554F	16,87	FD138E	22,00	DMX05272F	19,96	FD286E	22,00

		DELANTERAS				TRASERAS			
		PSYCHIC - EMGO		GALFER		PSYCHIC - EMGO		GALFER	
144 MX	15-	DMC05554F	16,87	FD138E	22,00	DMX05272F	19,96	FD286E	22,00
250 Enduro 4t	00-	DMC05554F	16,87	FD138E	22,00	DMC05553F	17,98	FD165E	22,00
250 EN	04-	DMC05554F	16,87	FD138E	22,00	DMX05272F	19,96	FD286E	22,00
250 EN F	04-	DMC05554F	16,87	FD138E	22,00	DMX05272F	19,96	FD286E	22,00
250 MX	05-	DMC05554F	16,87	FD138E	22,00	DMX05272F	19,96	FD286E	22,00
250 MX F	05-	DMC05554F	16,87	FD138E	22,00	DMX05272F	19,96	FD286E	22,00
300 Enduro 4t	01-	DMC05554F	16,87	FD138E	22,00	DMC05553F	17,98	FD165E	22,00
300 EN	14-	DMC05554F	16,87	FD138E	22,00	DMX05272F	19,96	FD286E	22,00
300 MX	14-	DMC05554F	16,87	FD138E	22,00	DMX05272F	19,96	FD286E	22,00
300 MX	15-	DMC05554F	16,87	FD138E	22,00	DMX05272F	19,96	FD286E	22,00
400 4t E/Cross	00-02	DMC05554F	16,87	FD138E	22,00	DMC05553F	17,98	FD165E	22,00
400 4t E/Cross	03-	DMC05554F	16,87	FD138E	22,00	E64-51880	16,76	FD093E	22,00
450 EN F	04-	DMC05554F	16,87	FD138E	22,00	DMX05272F	19,96	FD286E	22,00
450 MX F	05-	DMC05554F	16,87	FD138E	22,00	DMX05272F	19,96	FD286E	22,00
530 4t E/Cross	03-	DMC05554F	16,87	FD138E	22,00	E64-51880	16,76	FD093E	22,00
530 EN F	04-	DMC05554F	16,87	FD138E	22,00	DMX05272F	19,96	FD286E	22,00
530 MX F	05-	DMC05554F	16,87	FD138E	22,00	DMX05272F	19,96	FD286E	22,00

YAMAHA									
	Año	Referencia	P.V.P.	Referencia	P.V.P.	Referencia	P.V.P.	Referencia	P.V.P.
YZ 80	93-02			FD097B	17,90	DAT05505F	14,67	FD299B	15,60
YZ 85	03-			FD097B	17,90	DAT05505F	14,67	FD299B	15,60
WR 125	90-97	E64-71971	16,45	FD086E	22,00	E64-81372	16,96	FD114E	22,00
WR 125	98-02	DMX05286F	16,91	FD164E	22,00	E64-51880	16,76	FD093E	22,00
WR 125	03-07	DMX05286F	16,91	FD164E	22,00	DMX05272F	19,96	FD286E	22,00
WR 125 R	09-			FD266B	24,60	DMC05553F	17,98	FD165E	22,00
YZ 125	08-	DMX05291F	16,91	FD364E	22,00	DMX05272F	19,96	FD286E	22,00
YZ 125	90-97	E64-71971	16,45	FD086E	22,00	E64-81372	16,96	FD114E	22,00
YZ 125	98-02	DMX05286F	16,91	FD164E	22,00	E64-51880	16,76	FD093E	22,00
YZ 125	03-07	DMX05286F	16,91	FD164E	22,00	DMX05272F	19,96	FD286E	22,00
YZ 125	08-14	DMX05291F	16,91			DMX05272F	19,96		
WR 200 R	93-	E64-71971	16,45	FD086E	22,00	E64-81372	16,96	FD114E	22,00
TT 225 R	00-			FD079B	17,90				
TTR 230	05-12	DAT05561F	15,82			DAT05462M			
TT 250	86-92			FD080B	20,20				
TT 250 R	93-	E64-71971	16,45	FD086E	22,00	E64-81372	16,96	FD114E	22,00
WR 250	91-98	E64-71971	16,45	FD086E	22,00	E64-81372	16,96	FD114E	22,00
WR 250	99-02	DMX05286F	16,91	FD164E	22,00	E64-51880	16,76	FD093E	22,00
WR 250 F 4T	99-02	DMX05286F	16,91	FD164E	22,00	E64-51880	16,76	FD093E	22,00
WR 250 F 4T	03-06	DMX05286F	16,91	FD164E	22,00	DMX05272F	19,96	FD286E	22,00
WR 250 F 4T	07-	DMX05291F	16,91	FD364E	22,00	DMX05272F	19,96	FD286E	22,00
WR 250 R	08-	DMX05286F	16,91	FD164E	22,00	DMX05272F	19,96	FD286E	22,00
WR 250 X	08-					DMX05272F	19,96		
YZ 250	92-98	E64-71971	16,45	FD086E	22,00	E64-81372	16,96	FD114E	22,00
YZ 250	99-	DMX05286F	16,91	FD164E	22,00	E64-51880	16,76	FD093E	22,00
YZ 250	08-	DMX05291F	16,91	FD364E	22,00	DMX05272F	19,96	FD286E	22,00
YZ 250 F	00-02	DMX05286F	16,91	FD164E	22,00	E64-51880	16,76	FD093E	22,00
YZ 250 F	03-06	DMX05286F	16,91	FD164E	22,00	DMX05272F	19,96	FD286E	22,00
YZ 250 F	07-	DMX05291F	16,91	FD364E	22,00	DMX05272F	19,96	FD286E	22,00
TT 350	87-91			FD080B	20,20				
YZ 360	90-	E64-71971	16,45	FD086E	22,00	E64-81372	16,96	FD114E	22,00
WR 400 F	98-99	DMX05286F	16,91	FD164E	22,00	E64-51880	16,76	FD093E	22,00
YZ 400 F	98-99	DMX05286F	16,91	FD164E	22,00	E64-51880	16,76	FD093E	22,00
WR 426 F	00-02	DMX05286F	16,91	FD164E	22,00	E64-51880	16,76	FD093E	22,00
YZ 426 F	00-02	DMX05286F	16,91	FD164E	22,00	E64-51880	16,76	FD093E	22,00
WR 450 F	03-	DMX05286F	16,91	FD164E	22,00	DMX05272F	19,96	FD286E	22,00
YZ 450 F	03-07	DMX05286F	16,91	FD164E	22,00	DMX05272F	19,96	FD286E	22,00
YZ 450 F	08-11	DMX05291F	16,91	FD364E	22,00	DMX05272F	19,96	FD286E	22,00
YZ 490	86-			FD080B	20,20				
YZ 490 RALLY	90-			FD080B	20,20				
WR 500	92-	E64-71971	16,45	FD086E	22,00	E64-81372	16,96	FD114E	22,00
TT 600	90-92			FD080B	20,20				
TT 600	93-94	E64-71971	16,45	FD086E	22,00	E64-81372	16,96	FD114E	22,00
TT 600	95-97	DMC05554F	16,87	FD138E	22,00	DMC05553F	17,98	FD165E	22,00
TT 600 S	94-			FD079B	17,90			FD079B	17,90
TT 600 R	99-02	DMC05554F	16,87	FD138E	22,00	DMC05553F	17,98	FD165E	22,00
TT 600 RE	03-	DMC05554F	16,87	FD138E	22,00	DMC05553F	17,98	FD165E	22,00

RUEDAS Y NEUMÁTICOS

MOTOR

ADMISIÓN / ESCAPE
REFRIGERACIÓN

ELECTRICO

SUSPENSIÓN / DIRECCIÓN

FRENOS

TRANSMISIÓN

CONTROLES Y MANDOS

CHASIS

ACCESORIOS



Discos de freno



GAS GAS	Año	DELANTERO		TRASERO	
		Referencia	P.V.P.	Referencia	P.V.P.
EC 400 FSE	01-14			DMX05516	63,69

HM	Año	DELANTERO		TRASERO	
		Referencia	P.V.P.	Referencia	P.V.P.
CRE 125	03-14	DMX05529	63,69	DMX05519	62,30
CRE 250 F	03-14	DMX05529	63,69	DMX05519	62,30
CRE 250 R	03-08	DMX05529	63,69	DMX05519	62,30
CRE 250 X	09-14	DMX05529	63,69	DMX05519	62,30
CRF 250 R	09-14	DMX05529	63,69	DMX05519	62,30
CRF 250 R	15-16	DMX05578			
CRM 250 X	07-14	DMX05529	63,69	DMX05519	62,30
CRE 300 X	09-14	DMX05529	63,69	DMX05519	62,30
CRE 450 F	03-14	DMX05529	63,69	DMX05519	62,30
CRE 450 R	09-14	DMX05529	63,69	DMX05519	62,30
CRE 450 X	09-14	DMX05529	63,69	DMX05519	62,30
CRF 450 R	09-14	DMX05529	63,69	DMX05519	62,30
CRF 450 R	15-16	DMX05578			
CRMF 450 R	09-14	DMX05529	63,69	DMX05519	62,30
CRMF 450 X	09-14	DMX05529	63,69	DMX05519	62,30
CREF 490 X	07-14	DMX05529	63,69	DMX05519	62,30
CREM 490 X	07-14	DMX05529	63,69	DMX05519	62,30
CRE 500 X	09-14	DMX05529	63,69	DMX05519	62,30

HONDA	Año	DELANTERO		TRASERO	
		Referencia	P.V.P.	Referencia	P.V.P.
CR 80	97-02	DMX05518	53,92	DMX05500	51,10
CR 85	03-07	DMX05518	53,92	DMX05500	51,10
CR 125	02-07	DMX05529	63,69	DMX05519	62,30
CRF 230 F	03-15	DMX05549	64,45		
CRF 230 L	08-11	DMX05549	64,45	DMX05552	64,88
CRF 230 M	09-11	DMX05549	64,45	DMX05552	64,88
CR 250 R	02-07	DMX05529	63,69	DMX05519	62,30
CRF 250 R	04-14	DMX05529	63,69	DMX05519	62,30
CRF 250 R				DMX05519	62,30
CRF 250 X	04-15	DMX05529	63,69	DMX05519	62,30
XR 250 L	91-93	DMX05549	64,45	DMX05552	64,88
XR 250 R	94-03	DMX05549	64,45	DMX05552	64,88
XR 400 R	96-04	DMX05549	64,45	DMX05552	64,88
CRF 450 R	01-03	DMX05529	63,69		
CRF 450 R	04-14	DMX05529	63,69	DMX05519	62,30
CRF 450 R	2015			DMX05519	62,30
CRF 450 X	04-15	DMX05529	63,69	DMX05519	62,30
CR 500 R	92-94	DMX05549	64,45		
CR 500 R	95-00	DMX05529	63,69		
XR 600 R	84-90	DMX05549	64,45		
XR 600 R	91-00	DMX05549	64,45	DMX05552	64,88
XR 650 L	93-14	DMX05549	64,45	DMX05552	64,88
XR 650 R	00-07	DMX05549	64,45		

HUSABERG	Año	DELANTERO		TRASERO	
		Referencia	P.V.P.	Referencia	P.V.P.
TE 125	11-	DMX05515	64,45	DMX05516	63,69
FE 250	13-	DMX05515	64,45	DMX05516	63,69
TE 250	11-	DMX05515	64,45	DMX05516	63,69
TE 300	11-	DMX05515	64,45	DMX05516	63,69
FE 350	13	DMX05515	64,45	DMX05516	63,69
FE 390	10-	DMX05515	64,45	DMX05516	63,69

FE 400	00-	DMX05515	64,45	DMX05516	63,69
FC 450	04-	DMX05515	64,45	DMX05516	63,69
FC 450	04-	DMX05515	64,45	DMX05516	63,69
FE 450	12-	DMX05515	64,45	DMX05516	63,69
FS 450	04			DMX05516	63,69
FSE 450	05-			DMX05516	63,69
FX 450	10-	DMX05515	64,45	DMX05516	63,69
FE 501	13-	DMX05515	64,45	DMX05516	63,69
FC 550	04-	DMX05515	64,45	DMX05516	63,69
FE 550	04-	DMX05515	64,45	DMX05516	63,69
FE 570	09-	DMX05515	64,45	DMX05516	63,69
FC 650	04-	DMX05515	64,45	DMX05516	63,69
FE 650	04-	DMX05515	64,45	DMX05516	63,69

HUSQVARNA	Año	DELANTERO		TRASERO	
		Referencia	P.V.P.	Referencia	P.V.P.
125 TC	14-15	DMX05515	64,45	DMX05516	63,69
125 TE	14-15	DMX05515	64,45	DMX05516	63,69
250 FC	14-15	DMX05515	64,45	DMX05516	63,69
250 FE	14-15	DMX05515	64,45	DMX05516	63,69
250 TC	14-15	DMX05515	64,45	DMX05516	63,69
250 TE	14-15	DMX05515	64,45	DMX05516	63,69
450 FC	14-15	DMX05515	64,45	DMX05516	63,69
501 FE	14-15	DMX05515	64,45	DMX05516	63,69

KAWASAKI	Año	DELANTERO		TRASERO	
		Referencia	P.V.P.	Referencia	P.V.P.
KX 80	86-92	DMX05533	59,35		
KX 80	93-96	DMX05533	59,35	DMX05522	49,37
KX 80	97-99	DMX05533	59,35	DMX05522	49,37
KX 85	00-14	DMX05533	59,35	DMX05522	49,37
KX 100	97-14	DMX05533	59,35	DMX05522	49,37
KX 125	89-02	DMX05520	67,05	DMX05521	59,02
KX 125	03-05	DMX05536	64,45	DMX05531	59,78
KX 125	06-07	DMX05539	65,86	DMX05531	59,78
KLX 250 S	05-07	DMX05520	67,05		
KX 250	89-02	DMX05520	67,05	DMX05521	59,02
KX 250	03-05	DMX05536	64,45	DMX05531	59,78
KX 250	06-07	DMX05539	65,86	DMX05531	59,78
KX 250 F	04-05	DMX05536	64,45	DMX05531	59,78
KX 250 F	06-14	DMX05539	65,86	DMX05531	59,78
KX 250 F	15-16	DMX05576		DMX05531	59,78
KLX 400 R	03-06	DMX05520	67,05	DMX05521	59,02
KLX 450 R	07-12	DMX05539	65,86	DMX05531	59,78
KX 450 F	06-14	DMX05539	65,86	DMX05531	59,78
KX 450 F	15-16	DMX05576		DMX05531	59,78

KTM	Año	DELANTERO		TRASERO	
		Referencia	P.V.P.	Referencia	P.V.P.
EXC 125	95-03	DMX05515	64,45	DMX05516	63,69
EGS 125	95-03	DMX05515	64,45	DMX05516	63,69
SX 125	95-03	DMX05515	64,45	DMX05516	63,69
SX 144	08-	DMX05515	64,45	DMX05516	63,69
XC 150	10-14	DMX05515	64,45	DMX05516	63,69
EGS 200	99-02	DMX05515	64,45	DMX05516	63,69
EXC 200	98-	DMX05515	64,45	DMX05516	63,69
SX 200	03-	DMX05515	64,45	DMX05516	63,69
ENDURO 250	92-	DMX05515	64,45	DMX05516	63,69
EGS 250	99-	DMX05515	64,45	DMX05516	63,69
EXC 250 4T	03-	DMX05515	64,45	DMX05516	63,69



Discos de freno



EXC-F 250	2015	DMX05515	64,45	DMX05516	63,69
GS 250	93-	DMX05515	64,45	DMX05516	63,69
SX 250	94-	DMX05515	64,45	DMX05516	63,69
SXF 250	2015	DMX05515	64,45	DMX05516	63,69
ENDURO 300	92-	DMX05515	64,45	DMX05516	63,69
EXC 300	03-	DMX05515	64,45	DMX05516	63,69
EXC-E 300	08-	DMX05515	64,45	DMX05516	63,69
GS 300	91-			DMX05516	63,69
MXC 300	04-	DMX05515	64,45	DMX05516	63,69
SX 300	93-03	DMX05515	64,45	DMX05516	63,69
EGS 300	93-03	DMX05515	64,45	DMX05516	63,69
XC 300	93-03	DMX05515	64,45	DMX05516	63,69
XC-W 300	06-	DMX05515	64,45	DMX05516	63,69
EXC-F 350	12-	DMX05515	64,45	DMX05516	63,69
MX 350	92-	DMX05515	64,45	DMX05516	63,69
SX-F 350	11-	DMX05515	64,45	DMX05516	63,69
SX Factory 350	10-	DMX05515	64,45	DMX05516	63,69
XC-F 350	11-	DMX05515	64,45	DMX05516	63,69
EXC 400	04-	DMX05515	64,45	DMX05516	63,69
EXC 450	03-	DMX05515	64,45	DMX05516	63,69
MXC 450	04-	DMX05515	64,45	DMX05516	63,69
SX 450	03-	DMX05515	64,45	DMX05516	63,69
SX-F 450	07-	DMX05515	64,45	DMX05516	63,69
XC 450	06-	DMX05515	64,45	DMX05516	63,69
EXC 500	14-	DMX05515	64,45	DMX05516	63,69
MX 500	92-	DMX05515	64,45	DMX05516	63,69
SX 500	93-	DMX05515	64,45	DMX05516	63,69
SX 505	07-	DMX05515	64,45	DMX05516	63,69
EXC 525	03-	DMX05515	64,45	DMX05516	63,69
MXC 525	04-	DMX05515	64,45	DMX05516	63,69
SX 525	03-	DMX05515	64,45	DMX05516	63,69
EXC-R 530	08-	DMX05515	64,45	DMX05516	63,69
XC 530	08-	DMX05515	64,45	DMX05516	63,69
XCW 530	08-	DMX05515	64,45	DMX05516	63,69

XC SIX DAYS 530	10-	DMX05515	64,45	DMX05516	63,69
XC 550	94-	DMX05515	64,45	DMX05516	63,69

SUZUKI

Año	DELANTERO		TRASERO		
	Referencia	P.V.P.	Referencia	P.V.P.	
RM 85	05-12	DMX05540	57,18	DMX05541	49,04
RM 125	88-98	DMX05513	60,98	DMX05514	61,52
RM 125	99-08	DMX05513	60,98	DMX05517	63,69
DRZ 250 E	01-07	DMX05513	60,98		
RM 250	87-98	DMX05513	60,98	DMX05514	61,52
RM 250	99-08	DMX05513	60,98	DMX05517	63,69
RMZ 250	04-06	DMX05536	64,45	DMX05331	61,52
RMZ 250	07-14	DMX05537	61,09	DMX05538	60,98
RMX 250	95-98	DMX05513	60,98	DMX05514	61,52
DRZ 400	00-14	DMX05513	60,98	DMX05514	61,52
RMZ 450	05-14	DMX05537	61,09	DMX05538	60,98
RMX 450	2010	DMX05537	61,09	DMX05538	60,98

YAMAHA

Año	DELANTERO		TRASERO		
	Referencia	P.V.P.	Referencia	P.V.P.	
YZ 80	93-02	DMX05535	60,09	DMX05527	53,17
YZ 85	03-15	DMX05535	60,09	DMX05527	53,17
YZ 125	01-02	DMX05523	62,71	DMX05512	61,52
YZ 125	03-15	DMX05523	62,71	DMX05525	64,12
WR 250	2001	DMX05523	62,71	DMX05525	64,12
WR 250 F	2001	DMX05523	62,71	DMX05512	61,52
WR 250 F	02-15	DMX05523	62,71	DMX05525	64,12
YZ 250	2001	DMX05523	62,71	DMX05525	64,12
YZ 250 F	02-15	DMX05523	62,71	DMX05525	64,12
YZ 250 F	01-02	DMX05523	62,71	DMX05512	61,52
YZ 250 F	03-15	DMX05523	62,71	DMX05525	64,12
YZ 250 F	2016	DMX05577			
WR 426 F	00-01	DMX05523	62,71	DMX05512	61,52
YZ 426 F	00-01	DMX05523	62,71	DMX05512	61,52
WR 450 F	03-15	DMX05523	62,71	DMX05525	64,12
YZ 450 F	03-15	DMX05523	62,71	DMX05525	64,12
YZ 450 F	2016	DMX05577			

Separador de pistón pinza de freno

Referencia	P.V.P.
DUP12075	17,13



Separador de pistón pinza de freno

Separa de un mínimo de 6,4mm a un máximo de 58mm

Referencia	P.V.P.
DUP12074	47,34





Kit reparación bomba de freno



HONDA	Año	Posición	Referencia	P.V.P.
CR 80 R	98-99	Delantero	DMX05605	18,48
CR 80 R	00-02	Delantero	DMX05604	18,48
CR 85 R	03-07	Delantero	DMX05604	18,48
CR 125	86-99	Delantero	DMX05605	18,48
CR 125	00-07	Delantero	DMX05604	18,48
CRF 125 F	14-15	Delantero	DMX05624	20,86
CRF 150 F	03-15	Delantero	DMX05624	20,86
CRF 150 R	07-14	Delantero	DMX05604	18,48
CRF 230 F	03-15	Delantero	DMX05624	20,86
CR 250	87-99	Delantero	DMX05605	18,48
CR 250 R	1986	Delantero	DMX05605	18,48
CRF 250 R	04-06	Delantero	DMX05604	18,48
CRF 250 R	07-15	Delantero	DMX05623	20,46
CRF 250 X	04-13	Delantero	DMX05604	18,48
XR 250 R	96-99	Delantero	DMX05605	18,48
XR 250 R	00-04	Delantero	DMX05604	18,48
XR 350 R	1985	Delantero	DMX05605	18,48
XR 400 R	96-99	Delantero	DMX05605	18,48
XR 400 R	00-03	Delantero	DMX05604	18,48
CRF 450 R	02-06	Delantero	DMX05604	18,48
CRF 450 R	07-15	Delantero	DMX05623	20,46
CRF 450 X	05-14	Delantero	DMX05604	18,48
CR 500 R	86-99	Delantero	DMX05605	18,48
CR 500 R	00-01	Delantero	DMX05604	18,48
XR 600 R	1985	Delantero	DMX05605	18,48
XR 650 R	00-07	Delantero	DMX05604	18,48

KAWASAKI	Año	Posición	Referencia	P.V.P.
KX 80	94-96	Delantero	DMX05613	18,48
KX 85	01-13	Delantero	DMX05609	18,48
KX 100	95-96	Delantero	DMX05613	18,48
KX 100	01-13	Delantero	DMX05609	18,48
KX 125	94-96	Delantero	DMX05613	18,48
KX 125	97-99	Delantero	DMX05608	22,18
KX 125	01-05	Delantero	DMX05609	18,48
KDX 200	95-06	Delantero	DMX05613	18,48
KDX 220 R	98-05	Delantero	DMX05613	18,48
KLX 250	94-96	Delantero	DMX05613	18,48
KX 250	97-99	Delantero	DMX05608	22,18
KX 250	01-07	Delantero	DMX05609	22,18
KX 250 F	06-11	Delantero	DMX05609	18,48
KX 250 F	13-14	Delantero	DMX05625	18,48
KLX 300 R	97-07	Delantero	DMX05613	18,48
KX 450 F	06-11	Delantero	DMX05609	18,48
KX 450 F	13-14	Delantero	DMX05625	18,48
KX 500	94-96	Delantero	DMX05613	18,48
KX 500	2004	Delantero	DMX05609	18,48

KTM	Año	Posición	Referencia	P.V.P.
125 SX	06-08	Delantero	DMX05602	18,48
125 SX	09-13	Delantero	DMX05603	21,78
144 SX	2008	Delantero	DMX05602	18,48
144 SX-F	2008	Delantero	DMX05602	18,48
150 SX	09-12	Delantero	DMX05603	21,78
150 XC	10-13	Delantero	DMX05603	21,78
200 EXC	2005	Delantero	DMX05601	18,48
200 XC	06-09	Delantero	DMX05602	18,48
200 XC-W	06-09	Delantero	DMX05602	18,48
200 XC-W	10-13	Delantero	DMX05603	21,78

250 SX	09-13	Delantero	DMX05603	21,78
250 SX-F	09-13	Delantero	DMX05603	21,78
250 XC	08-09	Delantero	DMX05602	18,48
250 XC	10-13	Delantero	DMX05603	21,78
250 XC-F	06-09	Delantero	DMX05602	18,48
250 XC-F	11-13	Delantero	DMX05603	21,78
250 XCF-W	07-10	Delantero	DMX05602	18,48
250 XCF-W	11-13	Delantero	DMX05603	21,78
250 XC-W	10-13	Delantero	DMX05603	21,78
300 EXC	2005	Delantero	DMX05601	18,48
300 MXC	2005	Delantero	DMX05601	18,48
300 XC	06-09	Delantero	DMX05602	18,48
300 XC	10-13	Delantero	DMX05603	21,78
300 XC-W	06-09	Delantero	DMX05602	18,48
300 XC-W	10-13	Delantero	DMX05603	21,78
350 EXC-F	12-13	Delantero	DMX05603	21,78
350 SX-F	11-13	Delantero	DMX05603	21,78
350 XC-F	11-13	Delantero	DMX05603	21,78
350 XCF-W	12-13	Delantero	DMX05603	21,78
400 EXC Racing	2005	Delantero	DMX05601	18,48
400 EXC-G Racing	2005	Delantero	DMX05601	18,48
400 XC-W	07-09	Delantero	DMX05602	18,48
400 XC-W	2010	Delantero	DMX05603	21,78
450 EXC	10-11	Delantero	DMX05603	21,78
450 EXC Racing	2005	Delantero	DMX05601	18,48
450 EXC-G Racing	2005	Delantero	DMX05601	18,48
450 EXC-R	2008	Delantero	DMX05602	18,48
450 SX Racing	2005	Delantero	DMX05601	18,48
450 SX Racing	2006	Delantero	DMX05602	18,48
450 SXS	2006	Delantero	DMX05602	18,48
450 SX-F	07-08	Delantero	DMX05602	18,48
450 SX-F	09-13	Delantero	DMX05603	21,78
450 SXS Racing	2005	Delantero	DMX05601	18,48
450 XC	2007	Delantero	DMX05602	18,48
450 XC-F	2013	Delantero	DMX05603	21,78
450 XCF	08-09	Delantero	DMX05602	18,48
450 XC-W	07-10	Delantero	DMX05602	18,48
450 XC-W	10-13	Delantero	DMX05603	21,78
450 XCRW	2008	Delantero	DMX05602	18,48
500 EXC	12-13	Delantero	DMX05603	21,78
500 XC-W	12-13	Delantero	DMX05603	21,78
505 SX-F	2008	Delantero	DMX05602	18,48
505 XCF	2008	Delantero	DMX05602	18,48
525 EXC Racing	2005	Delantero	DMX05601	18,48
525 EXC-G Racing	2005	Delantero	DMX05601	18,48
525 MXC-G Racing	2005	Delantero	DMX05601	18,48
525 SX Racing	2005	Delantero	DMX05601	18,48
525 SX Supermoto	2005	Delantero	DMX05601	18,48
525 XC	2007	Delantero	DMX05602	18,48
525 XCW	2007	Delantero	DMX05602	18,48
530 EXC	10-11	Delantero	DMX05603	21,78
530 EXC-R	2008	Delantero	DMX05602	18,48
530 XC-W	10-11	Delantero	DMX05603	21,78
530 XCRW	2008	Delantero	DMX05602	18,48
540 SXS	2006	Delantero	DMX05602	18,48
540 SXS Racing	2005	Delantero	DMX05601	18,48
625 SXC	06-07	Delantero	DMX05600	18,48
660 Rally	06-07	Delantero	DMX05600	18,48
690 Rally	07-09	Delantero	DMX05600	18,48
todos los modelos	01-04	Delantero	DMX05600	18,48



Kit reparación bomba de freno



SUZUKI	Año	Posición	Referencia	P.V.P.
RM 80	89-01	Delantero	DMX05615	18,88
RM 85	05-12	Delantero	DMX05610	19,80
RM 125	89-95	Delantero	DMX05615	18,88
RM 125	96-03	Delantero	DMX05611	21,12
RM 125	04-08	Delantero	DMX05610	19,80
DR 200 SE	96-13	Delantero	DMX05620	20,46
DR-Z 250	01-07	Delantero	DMX05615	18,88
RM 250	89-95	Delantero	DMX05615	18,88
RM 250	96-00	Delantero	DMX05611	21,12
RM 250	01-08	Delantero	DMX05610	19,80
RMX 250	89-98	Delantero	DMX05615	18,88
RM-Z 250	07-13	Delantero	DMX05610	19,80
DR 350	90-99	Delantero	DMX05615	18,88
DR 350 SE	90-99	Delantero	DMX05620	20,46
DR-Z 400	00-07	Delantero	DMX05611	21,12
DR-Z 400 E	00-07	Delantero	DMX05611	21,12
DR-Z 400 S	00-12	Delantero	DMX05620	20,46
DR-Z 400 SM	00-12	Delantero	DMX05620	20,46
RM-Z 450	05-13	Delantero	DMX05610	19,80
RMX 450	2011	Delantero	DMX05610	19,80
DR 650 SE	96-09	Delantero	DMX05621	20,86

YAMAHA	Año	Posición	Referencia	P.V.P.
YZ 80	86-96	Delantero	DMX05616	18,88
YZ 80	2001	Delantero	DMX05606	17,56
YZ 85	02-09	Trasero	DMX05606	17,56
YZ 85	05-14	Delantero	DMX05607	17,82
YZ 125	86-89	Delantero	DMX05616	18,88
YZ 125	90-95	Delantero	DMX05617	18,88
YZ 125	2001	Delantero	DMX05606	17,56

YZ 125	02-07	Delantero	DMX05607	17,82
YZ 125	08-14	Delantero	DMX05626	19,80
RT 180	1998	Delantero	DMX05616	18,88
TT-R 225	99-04	Delantero	DMX05616	18,88
TT-R 230	05-14	Delantero	DMX05607	17,82
WR 250 F	2001	Delantero	DMX05606	17,56
WR 250 F	02-09	Delantero	DMX05607	17,82
WR 250 Z	91-96	Delantero	DMX05617	18,88
YZ 250	86-89	Delantero	DMX05616	18,88
YZ 250	90-95	Delantero	DMX05617	18,88
YZ 250	2001	Delantero	DMX05606	17,56
YZ 250	03-07	Delantero	DMX05607	17,82
YZ 250	08-14	Delantero	DMX05626	19,80
YZ 250 F	2001	Delantero	DMX05606	17,56
YZ 250 F	02-06	Delantero	DMX05607	17,82
YZ 250 F	07-14	Delantero	DMX05626	19,80
YZ 250 WR	1989	Delantero	DMX05616	18,88
YZ 250 WR	1990	Delantero	DMX05617	18,88
WR 426 F	2001	Delantero	DMX05606	17,56
YZ 426 F	2001	Delantero	DMX05606	17,56
WR 450 F	02-09	Delantero	DMX05607	17,82
YZ 450 F	02-07	Delantero	DMX05607	17,82
YZ 450 F	08-14	Delantero	DMX05626	19,80
YZ 490	86-90	Delantero	DMX05616	18,88
WR 500	92-93	Delantero	DMX05617	18,88



RUEDAS Y NEUMÁTICOS

MOTOR

ADMISIÓN / ESCAPE
REFRIGERACIÓN

ELECTRICO

SUSPENSIÓN / DIRECCIÓN

FRENOS

TRANSMISIÓN

CONTROLES Y MANDOS

CHASIS

ACCESORIOS

XPEED Protector disco freno trasero

Proteje el disco de freno de caídas y golpes. Construido en material PEHD de 15mm, el grosor le confiere una rigidez inigualable, poco peso y mucho menos deformable que el aluminio.

GAS GAS	Año	Referencia
Todas (125 a 450cc)	00-09	P9208030
HONDA	Año	Referencia
CR 125	02-07	P9264030
CR 250	02-07	P9264030
CRF 250	02-15	P9264030
CRF 450	02-15	P9264030
KAWASAKI	Año	Referencia
KX 125	03-05	P9265030
KX 250	03-07	P9265030
KX 250 F	03-13	P9265030
KX 450 F	03-13	P9265030

SUZUKI	Año	Referencia
RM 125	05-08	P9259030
RM 250	05-08	P9259030
RMZ 250	07-15	P9259030
RMX 450	2010	P9259030
RMZ 450	05-15	P9259030
YAMAHA	Año	Referencia
YZ 125	99-15	P9261030
YZ 250	99-15	P9261030
YZ 250 F	01-15	P9261030
YZ 450 F	99-15	P9261030

P.V.P
22,23



PSYCHIC Disipador temperatura freno

La mejor solución para prevenir la ebullición del líquido de frenos, de forma rápida y barata. Los amantes del supermotard, tendrán la posibilidad de aumentar la frenada sin mayores costes que esta pieza. Fabricada en aluminio AL 6061

P.V.P
19,78



Referencia	Color	Descripción
DMX05332	M10 X P1.25 Japonesas	anodizado dorado
DMX05333	M10 X P1.0 Europeas	Anodizado naranja



TRANSMISIÓN





Piñones y coronas acero



Corona



Piñón normal

HONDA	DESARROLLO			PIÑÓN	NORMAL	RACING	CORONA	
	Año	Dientes Piñón-Corona	Cadena	Dientes	Referencia	Referencia	Dientes	Referencia
CR 125	87-96	13-51	114/520	12	DMX55112		47	DMX210471
CR 125	1997	12-49	112/520	13	DMX55113	DMX551134	48	DMX210481
CR 125	98-99	13-51	114/520	14	DMX55114		49	DMX210491
CR 125	00-01	13-52	114/520				50	DMX210501
CR 125	2002	13-51	114/520				51	DMX210511
CR 125	2003	13-52	116/520				52	DMX210521
CR 125	04-07	13-52	116/520	12	DMX55612		47	DMX210471
				13	DMX55613	DMX556134	48	DMX210481
				14	DMX55614	DMX556144	49	DMX210491
							50	DMX210501
							51	DMX210511
							52	DMX210521
							53	DMX210531
CRF 150 F	03-05	13-48	112/520	12	DMX322712		47	DMX210471
CRF 150 F	06-15	13-47	104/520	13	DMX322713		48	DMX210481
				14	DMX322714		49	DMX210491
				15	DMX322715		50	DMX210501
							51	DMX210511
							52	DMX210521
							53	DMX210531
CRF 150 R	07-15	15-50	120/420	12	DMX131012		49	DMX21549
				13	DMX131013		50	DMX21550
				14	DMX131014		51	DMX21551
				15	DMX131015			
CRF 230 F	03-15	13-50	110/520	12	DMX322712		47	DMX210471
				13	DMX322713		48	DMX210481
				14	DMX322714		49	DMX210491
				15	DMX322715		50	DMX210501
							51	DMX210511
							52	DMX210521
							53	DMX210531
CR 250 R	88-89	14-51	116/520				47	DMX210471
CR 250 R	90-91	14-53	116/520				48	DMX210481
CR 250 R	92-93	13-49	112/520	12	DMX56712	DMX567134	49	DMX210491
CR 250 R	94-95	13-49	114/520	13	DMX56713		50	DMX210501
CR 250 R	96-02	13-50	114/520	14	DMX56714		51	DMX210511
CR 250 R	2003	13-48	114/520				52	DMX210521
CR 250 R	2004	13-50	114/520				53	DMX210531
CR 250 R	2005	13-49	116/520					
CR 250 R	06-08	13-49	114/520					
CRF 250 R	04-10	13-51	114/520	12	DMX55612		47	DMX210471
CRF 250 R	11-15	13-49	116/520	13	DMX55613	DMX556134	48	DMX210481
CRF 250 X	04-15	14-53	116/520	14	DMX55614	DMX556144	49	DMX210491
							50	DMX210501
							51	DMX210511
							52	DMX210521
							53	DMX210531
XR 250 R	90-95	13-48	108/520	12	DMX322712		45	DMX80345
				13	DMX322713		48	DMX80348
				14	DMX322714			
				15	DMX322715			
XR 250 R	96-04	13-48	106/520	12	DMX132112		47	DMX210471
				13	DMX132113		48	DMX210481
				14	DMX132114		49	DMX210491
							50	DMX210501
							51	DMX210511
							52	DMX210521
							53	DMX210531
XR 400 R	96-04	15-45	108/520	13	DAT58713		47	DMX210471
				14	DAT58714		48	DMX210481
				15	DAT58715		49	DMX210491
							50	DMX210501
							51	DMX210511
							52	DMX210521
							53	DMX210531
CRF 450 R	02-03	13-50	114/520	13	DMX56713	DMX567134	47	DMX210471
CRF 450 R	04-15	13-48	114/520	14	DMX56714		48	DMX210481
CRF 450 X	05-15	13-51	114/520				49	DMX210491
							50	DMX210501
							51	DMX210511
							52	DMX210521
							53	DMX210531

Piñón racing

Hendiduras para desalajar el barro y agujeros para minimizar el peso.



Piñones y coronas acero

P.V.P
9

P.V.P
12

P.V.P
15

P.V.P
18

P.V.P
22

KAWASAKI	DESARROLLO			PIÑÓN		NORMAL	RACING	CORONA	
	Año	Dientes Piñón-Corona	Cadena	Dientes	Referencia		Referencia	Dientes	Referencia
KX 125	94-95	12-49	110/520					45	DMX28745
KX 125	96-97	13-50	112/520					46	DMX28746
KX 125	1998	12-48	112/520	12	DMX58412			47	DMX28747
KX 125	1999	12-47	110/520	13	DMX58413		DMX584134	48	DMX28748
KX 125	00-02	12-49	110/520					49	DMX28749
KX 125	2003	13-51	110/520					50	DMX28750
KX 125	04-08	13-51	114/520					51	DMX28751
								52	DMX28752
								53	DMX28753
KDX 200	89-94	13-47	110/520					45	DMX28745
KDX 200	95-06	13-47	108/520					46	DMX28746
KDX 220	97-05	13-47	108/520	11	DMX52611			47	DMX28747
KDX 250	91-94	14-48	112/520	12	DMX52612			48	DMX28748
KX 250	87-89	14-47	114/520	13	DMX52613			49	DMX28749
KX 250	90-91	14-48	114/520	14	DMX52614			50	DMX28750
KX 250	92-93	14-49	114/520	15	DMX52615			51	DMX28751
KX 250	94-96	14-49	112/520					52	DMX28752
KX 250	97-98	13-49	114/520					53	DMX28753
KX 250	99-01	14-49	114/520	12	DMX56512			45	DMX28745
KX 250	02-05	13-49	114/520	13	DMX56513		DMX565134	46	DMX28746
KX 250	06-08	13-51	116/520	14	DAT50414		DMX565144	47	DMX28747
								48	DMX28748
								49	DMX28749
								50	DMX28750
								51	DMX28751
								52	DMX28752
								53	DMX28753
KX 250 F	04-05	13-48	114/520	12	DMX50712			45	DMX28745
				13	DMX50713			46	DMX28746
				14	DMX50714			47	DMX28747
				15	DMX50715			48	DMX28748
								49	DMX28749
								50	DMX28750
								51	DMX28751
								52	DMX28752
								53	DMX28753
KX 250 F	06-10	13-48	112/520	13	DMX144613			45	DMX28745
KX 250 F	11-15	13-50	114/520	14	DMX144614			46	DMX28746
								47	DMX28747
								48	DMX28748
								49	DMX28749
								50	DMX28750
								51	DMX28751
								52	DMX28752
								53	DMX28753
KX 450	06-15	13-50	114/520	13	DMX156513		DMX1565134	45	DMX28745
				14	DMX156514			46	DMX28746
								47	DMX28747
								48	DMX28748
								49	DMX28749
								50	DMX28750
								51	DMX28751
								52	DMX28752
								53	DMX28753
KX 500	87-04	14-47	114/520	11	DMX52611			45	DMX28745
				12	DMX52612			46	DMX28746
				13	DMX52613			47	DMX28747
				14	DMX52614			48	DMX28748
				15	DMX52615			49	DMX28749
								50	DMX28750
								51	DMX28751
								52	DMX28752
								53	DMX28753



Piñones y coronas acero



KTM	Año	DESARROLLO		PIÑÓN			CORONA	
		Dientes Piñón-Corona	Cadena	Dientes	Referencia	Referencia	Dientes	Referencia
125 EXC	95-97	13-48						
125 EXC	98-99	13-50						
125 EXC	2000	14-38						
125 EXC	04-10	14-42						
125 EXC	12-15	14-50						
125 SX	95-15	13-50	118/520					
150 SX	08-14	14-50	120/520					
150 SX	2015	14-48						
200 EXC	98-99	14-50						
200 EXC	00-10	14-42	118/520					
200 SX	2002	14-45	118/520					
200 SX	03-06	14-45	112/520					
200 XC	06-10	14-48	118/520					
250 EXC	91-94	14-50	116/520					
250 EXC	96-98	14-50						
250 EXC	1999	14-50	118/520				38	DMX89738
250 EXC	00-03	15-48	118/520				39	DMX89739
250 EXC	05-11	13-40					40	DMX89740
250 EXC	12-15	14-50					41	DMX89741
250 EXC-F	07-11	14-38	118/520	12	DMX539912		42	DMX89742
250 EXC-F	12-13	14-50		13	DMX539913	DMX5399134	43	DMX89743
250 EXC-F	14-15	14-52		14	DMX539914	DMX5399144	44	DMX89744
250 SX	1995	13-50		15	DMX539915	DMX5399154	45	DMX89745
250 SX	97-03	14-50	118/520				46	DMX89746
250 SX	04-15	13-48	116/520				47	DMX89747
250 SX-F	06-12	13-48	116/520				48	DMX89748
250 SX-F	13-15	13-50					49	DMX89749
250 XC	07-14	14-50	114/520				50	DMX89750
250 XC	2015	13-50	114/520				51	DMX89751
250 XC-F	07-09	13-48					52	DMX89752
250 XC-F	12-14	13-50	118/520					
250 XC-W	10-15	13-50	118/520					
250 XCF-W	10-11	13-52						
250 XCF-W	12-15	13-50	118/520					
300 EXC	90-95	14-50	116/520					
300 EXC	95-97	14-50						
300 EXC	1998	14-52						
300 EXC	1999	14-50	118/520					
300 EXC	00-03	15-48						
300 EXC	2004	13-42						
300 EXC	05-11	13-40	116/520					
300 EXC	12-15	14-50						
400 EXC	00-02	15-48						
400 EXC	02-03	14-50	118/520					
400 EXC	04-11	15-45						
450 EXC Enduro Racing	03-12	15-45						
450 EXC Racing	13-15	14-52	116/520					
450 SX-F	07-12	14-52						



Piñón normal



Piñón racing





Piñones y coronas acero



SUZUKI	DESARROLLO			PIÑÓN	NORMAL	RACING	CORONA	
	Año	Dientes Piñón-Corona	Cadena	Dientes	Referencia	Referencia	Dientes	Referencia
RM 125	88-91	13-51	118/520	11	DMX42711		46	DMX808461
RM 125	92-96	12-49	114/520	12	DMX42712	DMX427124	47	DMX808471
RM 125	97-99	12-50	114/520	13	DMX42713		48	DMX808481
RM 125	00-05	12-49	114/520	14	DMX42714		49	DMX808491
RM 125	06-12	12-51	114/520				50	DMX808501
							51	DMX808511
							52	DMX808521
							53	DMX808531
RM 250	87-88	13-50	116/520				46	DMX808461
RM 250	89-97	13-49	116/520	13	DAT03229	DAT032294	47	DMX808471
RM 250	1998	13-50	114/520	14	DAT03230		48	DMX808481
RM 250	1999	13-49	114/520	15	DAT03231		49	DMX808491
RM 250	00-03	13-48	114/520				50	DMX808501
RM 250	04-12	13-50	114/520				51	DMX808511
							52	DMX808521
							53	DMX808531
RMZ 250	04-06	13-48	114/520	12	DMX50712		45	DMX28745
				13	DMX50713		46	DMX28746
				14	DMX50714		47	DMX28747
				15	DMX50715		48	DMX28748
							49	DMX28749
							50	DMX28750
							51	DMX28751
							52	DMX28752
							53	DMX28753
RMZ 250	07-09	12-48	112/520	11	DMX42711		46	DMX808461
RMZ 250	10-12	13-49	114/520	12	DMX42712	DMX427124	47	DMX808471
				13	DMX42713		48	DMX808481
				14	DMX42714		49	DMX808491
							50	DMX808501
							51	DMX808511
							52	DMX808521
							53	DMX808531
RMZ 250	13-15	13-49		13	DMX144213		46	DMX808461
				14	DMX144214		47	DMX808471
				15	DMX144215		48	DMX808481
							49	DMX808491
							50	DMX808501
							51	DMX808511
							52	DMX808521
							53	DMX808531
RMZ 450	05-07	14-49	116/520	13	DMX144113	DMX1441134	46	DMX808461
RMZ 450	08-12	13-50	114/520	14	DMX144114		47	DMX808471
RMX450	10-13	13-51	114/520	15	DMX144115		48	DMX808481
							49	DMX808491
							50	DMX808501
							51	DMX808511
							52	DMX808521
							53	DMX808531
RMZ 450	13-15	13-50	114/520	13	DMX144313		48	DMX808481
				14	DMX144314		49	DMX808491
				15	DMX144315		50	DMX808501
							51	DMX808511
							52	DMX808521
							53	DMX808531



RUEDAS Y NEUMÁTICOS

MOTOR

ADMISIÓN / ESCAPE REFRIGERACIÓN

ELÉCTRICO

SUSPENSIÓN / DIRECCIÓN

FRENOS

TRANSMISIÓN

CONTROLES Y MANDOS

CHASIS

ACCESORIOS



YAMAHA	DESARROLLO			PIÑÓN	NORMAL	RACING	CORONA	
	Año	Dientes Piñón-Corona	Cadena	Dientes	Referencia	Referencia	Dientes	Referencia
TTR 125	00-01	13-49	116/428	13 14	DMX54813 DMX54814		49	DMX83349
							49	DMX184349
							50	DMX184350
TTR 125 E	02-10	13-49	116/428	13	DMX54813		51	DMX184351
TTR 125 L	05-15	13-54	122/428	14	DMX54814		52	DMX184352
							53	DMX184353
							54	DMX184354
							46	DMX85346
							47	DMX85347
YZ 125	1988	13-49	112/520	12	DMX56312		48	DMX85348
YZ 125	89-92	13-51	116/520	13	DMX56313		49	DMX85349
YZ 125	93-96	13-50	116/520	14	DMX56314		50	DMX85350
YZ 125	97-98	13-48	112/520	15	DMX56315		51	DMX85351
							52	DMX85352
							53	DMX85353
				12	DMX56312		48	DMX25148
YZ 125	99-01	13-48	112/520	13	DMX56313		49	DMX25149
YZ 125	02-04	13-49	112/520	14	DMX56314		50	DMX25150
				15	DMX56315		51	DMX25151
							48	DMX25148
YZ 125	05-15	13-48	112/520	13	DMX50613	DMX1590134	49	DMX25149
				14	DMX50614		50	DMX25150
							51	DMX25151
				12	DAT56912		48	DMX25148
TTR 230	05-15	13-49	106/520	13	DAT56913		49	DMX25149
				14	DAT56914		50	DMX25150
							51	DMX25151
WR 250	1989	14-49	114/520				46	DMX85346
WR 250	1990	14-51	116/520	11	DMX52611		47	DMX85347
WR 250	91-92	14-52	116/520	12	DMX52612		48	DMX85348
WR 250	1993	14-51	116/520	13	DMX52613		49	DMX85349
WR 250	1994	14-52	116/520	14	DMX52614		50	DMX85350
WR 250	1995	15-52	116/520	15	DMX52615		51	DMX85351
WR 250	1996	14-52	116/520	16	DMX52616		52	DMX85352
WR 250	1997	14-49	112/520				53	DMX85353
WR 250	1998	14-48	112/520					
				12	DMX56512		48	DMX25148
WR 250 F	99-00	14-50	114/520	13	DMX56513	DMX565134	49	DMX25149
				14	DAT50414	DMX565144	50	DMX25150
							51	DMX25151
							47	DMX25147
							48	DMX25148
WR 250 F	01-06	13-52	114/520	13	DMX50613	DMX1590134	49	DMX25149
WR 250 F	07-10	13-50	114/520	14	DMX50614		50	DMX25150
WR 250 F	10-15	14-47	114/520				51	DMX25151
							52	DMX24552
							53	DMX24553
YZ 250	1979	14-48	108/520					
YZ 250	1980	14-48	106/520					
YZ 250	1981	14-48	110/520	11	DMX52611		46	DMX85346
YZ 250	82-84	13-48	112/520	12	DMX52612		47	DMX85347
YZ 250	85-86	14-50	114/520	13	DMX52613		48	DMX85348
YZ 250	87-89	14-49	114/520	14	DMX52614		49	DMX85349
YZ 250	90-91	14-51	116/520	15	DMX52615		50	DMX85350
YZ 250	1992	14-49	116/520	16	DMX52616		51	DMX85351
YZ 250	1993	14-51	116/520				52	DMX85352
YZ 250	94-97	13-49	114/520				53	DMX85353
YZ 250	1998	13-50	114/520					
YZ 250	99-01	14-50	114/520	12	DMX56512		48	DMX25148
YZ 250	02-04	14-49	114/520	13	DMX56513	DMX565134	49	DMX25149
YZ 250	05-15	14-50	114/520	14	DAT50414	DMX565144	50	DMX25150
							51	DMX25151
YZ 250 F	01-04	13-48	112/520				48	DMX25148
YZ 250 F	05-09	13-49	112/520	13	DMX50613	DMX1590134	49	DMX25149
YZ 250 F	10-13	13-51	114/520	14	DMX50614		50	DMX25150
YZ 250 F	14-15	13-50	114/520				51	DMX25151
WR 426 F	01-02	14-50	114/520					
YZ 426 F	00-02	14-48	114/520				47	DMX25147
WR 450 F	03-06	14-50	114/520				48	DMX25148
WR 450 F	07-09	13-50	114/520	12	DMX56512		49	DMX25149
WR 450 F	10-15	14-47	114/520	13	DMX56513	DMX565134	50	DMX25150
YZ 450 F	03-04	14-48	114/520	14	DAT50414	DMX565144	51	DMX25151
YZ 450 F	05-06	14-51	114/520				52	DMX24552
YZ 450 F	07-14	13-49	114/520				53	DMX24553
YZ 450 F	2015	13-48	114/520					



Cadenas

La cadena se sirve con enganche de clip.



Eslabones	Reforzada 420		Reforzada 428		Reforzada 428 OR con retenes "O"		Reforzada 520M sin retenes		Super reforzada 520H sin retenes		Super reforzada 520 ORM con retenes "O"	
	Ref.	P.V.P.	Ref.	P.V.P.	Ref.	P.V.P.	Ref.	P.V.P.	Ref.	P.V.P.	Ref.	P.V.P.
110	Z42110	26,57	Z43110	30,46	Z44110	39,77			Z52110	38,29	Z53110	57,81
112									Z52112	38,88	Z53112	58,78
114									Z52114	39,48	Z53114	59,76
116							Z59116	41,17	Z52116	40,08	Z53116	60,73
118											Z53118	61,71
120			Z43120	33,00	Z44120	43,11	Z59120	42,45			Z53120	62,68
122			Z43122	33,64								
130	Z42130	30,66										
Remache	Z42001	1,20	Z43001	1,20	Z44001	1,74	Z59001	1,44	Z52001	1,74	Z53001	1,84
Clip	Z42002	1,32	Z43002	1,50	Z44002	1,92	Z59002	2,20	Z52002	2,54	Z53002	2,82

Características técnicas

Rotura a	22000 kN	23000 kN	23400 kN	35000 kN	36800 kN	34000 kN
Hasta	110cc	150cc	425cc	450cc	675cc	700cc

Cadenas de retenes con aro de goma de perfil en "O", el aro de goma mantiene la grasa en el interior del eslabón impidiendo su salida, mantenimiento mínimo. Es la cadena más utilizada en el mercado de repuestos y también en origen.

PSYCHIC Rodillos cadena

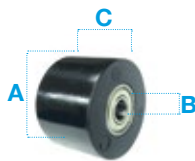

Referencia	Tipo	A	B	C	P.V.P.
DMC030394	B	32	6	29	5,61
DMC030397	B	32	8	29	6,75
DMC030395	B	42	6	29	6,75
DMC030398	B	42	8	29	6,87
DMC030396	A	35	8	19	6,98
DMC030399	D	39	8	23	7,56
DMC0303911	C	38	8	23	7,82
DMC0303910	B	32	8	23	7,82
DMC0303912	B	32	8	23,5	8,31
DMC0303913	B	42	8	23,5	8,31

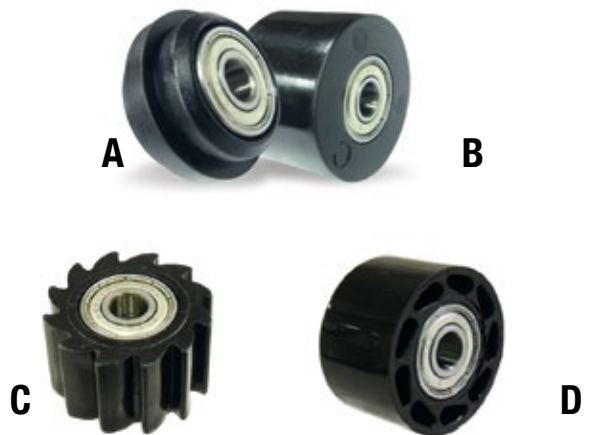

XPEED Limpiador de cadena

Referencia	P.V.P.
DUP12226	8,47



XPEED Mini corta cadenas

Referencia	P.V.P.
E84-56430	23,16





Protector piñón

HONDA	Año	Referencia
CRF 150 R	07-14	DMX03400
XR 250 BAJA	95-02	DMX03403
XR 250 MOTARD	03-07	DMX03403
CRM 250 R	91-98	DMX03402
CRM 250 AR	91-98	DMX03402
CR 250 R	02-07	DMX03401
CRF 250 R	04-09	DMX03401
CRF 250 R	10-14	DMX03440
CRF 250 X	04-15	DMX03401
CRF 450 R	05-07	DMX03400
CRF 450 R	2008	DMX03401
CRF 450 R	09-14	DMX03440
CRF 450 X	05-14	DMX03400

KAWASAKI	Año	Referencia
KX 125	03-08	DMX03408
KLX 150	09-14	DMX03441
D-TRACKER	98-14	DMX03411
KX 250	05-08	DMX03408
KX 250 F	04-14	DMX03409
KLX 250 ES	93-10	DMX03411
KLX 250 SR	93-10	DMX03411
KX 450 F	06-14	DMX03408
KLX 450 R	08-09	DMX03410

SUZUKI	Año	Referencia
RM 125	03-09	DMX03412
RM 250	99-09	DMX03412
RMZ 250	04-06	DMX03409
RMZ 250	07-14	DMX03404
DRZ 400 S	00-13	DMX03413
DRZ 400 S M	00-13	DMX03413
RMZ 450	05-14	DMX03404

YAMAHA	Año	Referencia
YZ 125	05-15	DMX03401
YZ 250	99-14	DMX03404
YZ 250 F	01-13	DMX03404
WR 250 F	01-10	DMX03404
WR 250 R	07-09	DMX03406
WR 250 X	07-09	DMX03406
TRICKER 250	04-09	DMX03407
XT 250 X	06-09	DMX03407
SEROW 250	05-09	DMX03407
YZ 450 F	03-13	DMX03405
WR 450 F	03-13	DMX03405

P.V.P
27



Protege el piñón y la cadena de interferencias externas. Su diseño ofrece una visión rápida del piñón.

Fabricado en aluminio y anodizado en dorado.



Protector de cadena

Construido en aluminio con el interior de plástico anti-desgaste. Anodizado en dorado.



P.V.P
42

HONDA	Año	Referencia
CR 125	90-04	DMX03416
CR 125	05-10	DMX03415
CR 250 R	90-04	DMX03416
CR 250 R	05-09	DMX03415
CRF 250	02-04	DMX03416
CRF 250	05-06	DMX03415
CRF 250	07-14	DMX03414
XR 250 R	86-04	DMX03414
XR 400 R	86-04	DMX03414
CRF 450 R	02-04	DMX03416
CRF 450 R	05-14	DMX03414
CRF 450 X	02-04	DMX03416
CRF 450 X	05-14	DMX03414
XR 600 R	85-00	DMX03414

KAWASAKI	Año	Referencia
KX 125	97-06	DMX03419
KLX 150	09-14	DMX03425
KD 220	Todas	DMX03421
KX 250	97-07	DMX03419
KX 250 F	04-05	DMX03419
KX 250 F	06-08	DMX03420
KX 250 F	09-12	DMX03424
KX 450 F	06-08	DMX03420
KX 450 F	09-12	DMX03424
KLX 450 R	08-10	DMX03419

KTM	Año	Referencia
125 Todas	98-06	DMX03422
250 Todas	94-97	DMX03422
300 Todas	94-95	DMX03422
360 Todas	96-97	DMX03422
380 Todas	98-06	DMX03422
EXC	08-14	DMX03427
SX	2007	DMX03427
SX	08-14	DMX03426
SX-F	2007	DMX03427
SX-F	08-14	DMX03426
XC	08-14	DMX03427

SUZUKI	Año	Referencia
RM 125	99-09	DMX03418
RMX 125	99-09	DMX03418
RM 250	99-09	DMX03418
RMX 250	99-09	DMX03418
RMZ 250	04-07	DMX03419
RMZ 250	06-07	DMX03418
DRZ 400	00-13	DMX03418
RMZ 450	05-14	DMX03418

YAMAHA	Año	Referencia
YZ 125	97-14	DMX03418
YZ 250	99-14	DMX03418
YZ 250 F	98-06	DMX03418
YZ 250 F	07-14	DMX03417
WR 250 F	07-14	DMX03417
YZ 400 F	98-99	DMX03418
YZ 426 F	00-02	DMX03418
YZ 450 F	03-06	DMX03418
YZ 450 F	07-14	DMX03417
WR 450 F	07-14	DMX03417



CONTROLES MANDOS



EMIGO Paramanos

Para proteger las manos de las piedras o del frío.
Fáciles de montar. Se venden solos o en cajas de 5 juegos.

Referencia	Descripción	P.V.P.
E79-97937	Paramanos Azul Yamaha	23,96
E79-97931	Paramanos Rojo Honda	23,96
E79-97934	Paramanos Negro	23,96
E79-97936	Paramanos Transparente	23,96
E79-97930	Paramanos Blanco	23,96
E79-97935	Paramanos Carbono	26,81
E79-97939	* Recambio anclajes	9,90

* Los pilotos que sustituyan el manillar y no deseen perder los protectores de manos, disponen de los anclajes interiores del manillar como recambio.



PSYCHIC Paramanos

Referencia	Descripción	P.V.P.
DMX12027BU	Paramanos Azul Yamaha	28,21
DMX12027RD	Paramanos Rojo Honda	28,21
DMX12027BK	Paramanos Negro	28,21
DMX12027YL	Paramanos Amarillo	28,21
DMX12027WI	Paramanos Blanco	28,21
DMX12027GN	Paramanos Verde	28,21



PSYCHIC Manillares aluminio Ø28

Manillar aluminio 7075T6
anodizado tipo tapered



Referencia	Descripción	P.V.P.
DMX08148BK	Manillar aluminio negro Ø 28mm (protector incluido), largo 790mm	58,35
DMX08148BU	Manillar aluminio azul Ø 28mm (protector incluido), largo 790mm	58,35
DMX08148GL	Manillar aluminio dorado Ø 28mm (protector incluido), largo 790mm	58,35
DMX08148OR	Manillar aluminio naranja Ø 28mm (protector incluido), largo 790mm	58,35
DMX08148RD	Manillar aluminio rojo Ø 28mm (protector incluido), largo 790mm	58,35
DMX08148TI	Manillar aluminio titanio Ø 28mm (protector incluido), largo 790mm	58,35

Calefacción manos

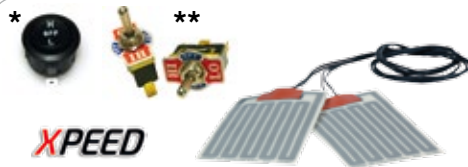

Ofrece una temperatura de confort a las manos.
Dispone de dos intensidades. Fácil montaje.
Se puede servir con dos modelos de interruptor.

Referencia		P.V.P.
D12170A	Calefactable *	28,20
D12170B	Calefactable **	28,20
D1216604	Interruptor recambio **	6,90

BRONCO

EMIGO

Elevadores manillar de aluminio

Eleva el manillar económicamente y sin trabajo, si eres alto podrás conducir más cómodamente y sin doblar tan pronunciadamente la espalda. Fabricados con aluminio AL 6061



Referencia	Descripción	Color	P.V.P.
DMX081101	de Ø 22 mm a 22 mm, 2 cm mas alto	aluminio	31,14
DMX081681	de Ø 22 mm a 22 mm, 2 cm mas alto	aluminio negro	33,38
DMX08169	de Ø 22 mm a 22 mm, 2 a 4 cm mas alto	aluminio	41,95
DMX08110	de Ø 22 mm a 28,6 mm, 2 cm mas alto	aluminio	31,14
DMX08168	de Ø 22 mm a 28,6 mm, 2 cm mas alto	aluminio negro	33,38
E23-08191	de Ø 22 mm a 28,6 mm, 2 cm mas alto	aluminio	39,78
DMX081691	de Ø 28,6 mm a 28,6 mm, 2 a 4 cm mas alto	aluminio	44,76
DMX08151	Elevador manillar moto Ø 28,6 mm	aluminio	36,12

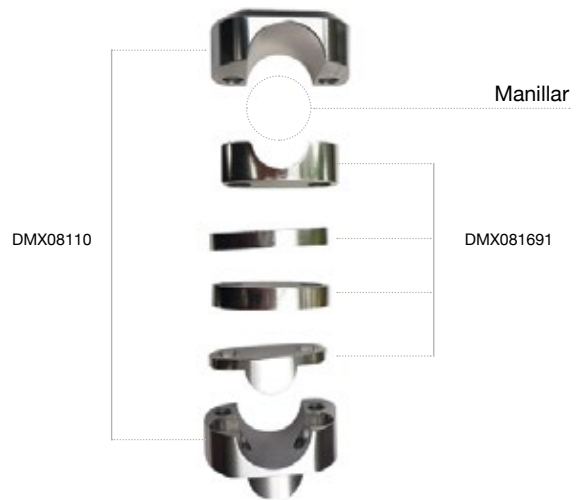

XPEED Puños



Referencia	Descripción	P.V.P.
DMX08020	Puños de goma Negros 22 - 24	7,36
DMX08027	Puños de goma Grises 22 - 24	7,36
R520111	Puños de goma Negros 22 - 24	7,36
R520113	Puños de goma Grises 22 - 24	7,36
R520121	Puños de goma Grises 22 - 24	7,36
R520153	Puños de goma Negros 22 - 24	7,36
R520171	Puños de goma Azules 22 - 24	7,36

XPEED Donuts



Referencia	Descripción	P.V.P.
R620010K	Protector de pulgar Negro	3,20

XPEED Varilla manillar



Referencia	Descripción	P.V.P.
RY100A	Varilla manillar Ø 22 Xpeed	13,80

RUEDAS Y NEUMÁTICOS

MOTOR

ADMISIÓN / ESCAPE
REFRIGERACIÓN

ELECTRICO

SUSPENSIÓN / DIRECCIÓN

FRENOS

TRANSMISIÓN

CONTROLES Y MANDOS

CHASIS

ACCESORIOS



Mando acelerador



Modelos específicos

HONDA	Año	Referencia	P.V.P
CR 125 R	93-03	D101054	21,33
CRF 230 F	03-07	DMX08660	15,64
CRF 250 R	04-08	DMX08660	15,64
CRF 250 X	04-12	DMX08660	15,64
CRF 450 R	02-08	DMX08660	15,64
CRF 450 X	05-14	DMX08660	15,64

KAWASAKI	Año	Referencia	P.V.P
KX 125	92-05	D101054	21,33
KX 250	92-05	D101054	21,33
KX 250 F		DMX08661	15,64

KTM	Año	Referencia	P.V.P
SXF 250	05-12	DMX08664	21,33
XCF 250	05-12	DMX08664	21,33
SXF 450	05-12	DMX08664	21,33
XCF 450	05-12	DMX08664	21,33
SXF 530	05-12	DMX08664	21,33
XCF 530	05-12	DMX08664	21,33

SUZUKI	Año	Referencia	P.V.P
RM 125	95-05	D101054	21,33
RM 250	95-05	D101054	21,33
RM 250 F		DMX08661	15,64

YAMAHA	Año	Referencia	P.V.P
YZ 125	96-10	D101054	21,33
YZ 250	96-10	D101054	21,33
YZ 250		DMX08661	15,64
WR 400		DMX08661	15,64
YZ 400		DMX08661	15,64
YZ 450 F		DMX08661	15,64



D101053

Modelos estándar

	Giro	Referencia	P.V.P
TIPO CR PRO	170° 1/2	D101053	15,64
TIPO VORTEX	95° 1/4	D101054	21,33
TIPO TURBO	150° 3/4	D101057	16,59
TIPO MOTION PRO	165° 1/2	D101059	15,64
TIPO MAGURA 313		DMX08662	15,64



Acelerador de aluminio

P.V.P
25



Para los pilotos que no quieren romper más la empuñadura de plástico del gas.

Para montar en manillares de 22 mm

Fabricado en aluminio AL 6061

Color aluminio con empuñadura de goma negra

HONDA	Año	Referencia
CR 125	93-08	DMX08658
CR 250	93-08	DMX08658
CRF 250	02-08	DMX08656
CRF 250 X	02-08	DMX08656
CRF 450	02-08	DMX08656
CR 500	93-08	DMX08656

KAWASAKI	Año	Referencia
KX 60	98-08	DMX08657
KX 65	00-08	DMX08657
KX 80	98-08	DMX08657
KX 85	98-08	DMX08657
KX 100	98-08	DMX08657
KX 125	93-08	DMX08657
KX 250	93-08	DMX08657
KXF 250	04-08	DMX08654
KXF 450	06-08	DMX08654

KTM	Año	Referencia
85 SX todas 2 t	97-08	DMX08658
400 todas 4 t	00-08	DMX08655
450 todas 4 t	00-08	DMX08655
520 todas 4 t	00-08	DMX08655
525 todas 4 t	00-08	DMX08655

SUZUKI	Año	Referencia
RM 65	03-08	DMX08657
RM 80	90-08	DMX08657
RM 85	02-08	DMX08657
RM 100	03-08	DMX08658
RM 125	96-08	DMX08657
RM 250	96-08	DMX08657
RMZ 250	04-08	DMX08654
RMX 450	05-08	DMX08654

YAMAHA	Año	Referencia
YZ 125	96-08	DMX08657
YZ 250	96-08	DMX08657
YZF 250	01-08	DMX08654
WRF 250	01-08	DMX08654
YZF 400	01-08	DMX08654
WRF 400	01-08	DMX08654
YZF 426	01-08	DMX08654
WRF 426	01-08	DMX08654
YZF 450	01-08	DMX08654
WRF 450	01-08	DMX08654



Cañas acelerador

P.V.P
6,82



GAS GAS	Año	Referencia
todos los modelos	96-08	D101079
TXT 250 PRO	04-13	D101079
TXT 300 PRO	04-13	D101079

HONDA	Año	Referencia
CR 80 R	85-00	D101085
CRF 80 R	04-13	D101087
CR 85 R	03-07	D101085
CRF 100 F	04-13	D101087
CR 125 R	89-07	D101079
CR 250 R	89-07	D101079
CRF 250 R	04-14	D101097
CRF 250 X	04-14	D101097
CRF 450 R	02-14	D101097
CRF 450 X	05-14	D101097
CR 500 R	90-00	D101079

HUSQVARNA	Año	Referencia
CR 125	00-12	D101079
WR 125	00-12	D101079
CR 250	00-05	D101079
WR 250	00-12	D101079

HUSABERG	Año	Referencia
FE 250	2013	D101079
FC 350	1996	D101079
FE 350	91-96	D101079
FE 350	2012	D101079
FE 390	10-12	D101079
FE 400 E	96-03	D101079
FC 400	96-99	D101079
FE 400	96-00	D101079
FC 450	04-05	D101079
FE 450 E	04-08	D101079
FE 450	09-13	D101079
FC 470	01-02	D101079
FC 470 E	2002	D101079
FC 499	92-93	D101079
FE 501	94-00	D101079
FE 501	89-00	D101079
FE 501	2013	D101079
FE 501 E	96-03	D101079
FC 550	01-04	D101079
FE 550 E	04-08	D101079
FE 570	09-12	D101079
FC 600	93-00	D101079
FE 600	93-96	D101079
FE 600	2003	D101079
FE 600 E	96-00	D101079

KAWASAKI	Año	Referencia
KX 60	84-03	D101092
KX 65	00-14	D101092
KX 80	89-00	D101092
KX 85	01-14	D101092
KX 100	95-14	D101092
KLX 110	02-14	D101092
KX125	92-02	DMX086531
KX250	92-07	DMX086531
KX 250 F	04-12	DMX08659
KLX 450 R	08-12	DMX08659
KX 450 F	06-14	DMX08659

KTM	Año	Referencia
85 SX 17/14	04-12	D101079
85 SX 19/16	05-10	D101079
105 SX	04-11	D101079
105 XC	08-09	D101079
125 EGS	98-99	D101079
125 EXC	98-07	D101079
125 EXE	00-01	D101079
125 SX	98-13	D101079
125 SXS	00-08	D101079
144 SX	07-08	D101079
150 SX	08-13	D101079
150 XC	10-13	D101079
200 EGS	98-99	D101079
200 EXC	98-05	D101079
200 MXC	98-03	D101079
200 SX	98-04	D101079
200 XC	06-09	D101079
200 XCW	03-13	D101079
250 EGS	98-99	D101079
250 EXC	97-05	D101079
250 MXC	98-03	D101079
250 SX	97-13	D101079
250 SX-F	05-11	D101098
250 XC	06-13	D101079
250 XC-F	07-09	D101098
250 XC-W	06-13	D101079
250 XCF-W	07-11	D101098
300 EGS	98-99	D101079
300 EXC	97-05	D101079
300 MXC	97-05	D101079
300 XC	06-13	D101079
300 XC-W	06-13	D101079
360 EXC	1997	D101079
360 MXC	1997	D101079
360 SX	1997	D101079
380 EGS	98-99	D101079

380 EXC	98-02	D101079
380 MXC	98-02	D101079
380 SX	98-02	D101079
400 EXC	01-05	D101098
400 MXC	01-02	D101098
400 SX	00-02	D101098
400 XC-W	2007	D101098
450 EXC	03-05	D101098
450 MXC	03-05	D101098
450 SMR	2005	D101098
450 SX-F	03-05	D101098
450 XC-F	07-09	D101098
450 XC-W	07-10	D101098
520 EXC	00-02	D101098
520 MXC	00-02	D101098
520 SX	00-02	D101098
525 EXC-G	06-07	D101098
525 MXC	03-05	D101098
525 SMR	04-05	D101098
525 SX	03-06	D101098
525 XC-G	06-07	D101098
525 XC-W	2007	D101098

SUZUKI	Año	Referencia
RM 125	95-07	DMX086531
RM 250	95-08	DMX086531
RMZ 250	04-12	DMX08659
RMZ 450	04-12	DMX08659

YAMAHA	Año	Referencia
YZ 125	96-14	DMX086531
YZ 250	96-12	DMX086531
WRF 400	98-00	DMX08659
YZF 400	98-99	DMX08659
WRF 426	01-02	DMX08659
YZF 426	00-02	DMX08659
WRF 450	03-12	DMX08659
YZF 450	03-12	DMX08659



Desmultiplicador embrague

Referencia	P.V.P.
DAT05700	20,93



Kit reparación de cables

Referencia	P.V.P.
DMP05092	5,28



RUEDAS Y NEUMÁTICOS

MOTOR

ADMISIÓN / ESCAPE
REFRIGERACIÓN

ELECTRICO

SUSPENSIÓN / DIRECCIÓN

FRENOS

TRANSMISIÓN

CONTROLES Y MANDOS

CHASIS

ACCESORIOS

CONTROLES Y MANDOS



Cables acelerador y embrague

HONDA	Año	Acelerador	P.V.P.	Embrague	P.V.P.
CRF 250 R	04-07	D102414	11,06	D102544	17,52
CRF 250 R	08-09	D102414	11,06	D102549	13,48
CRF 250 R	10-13	D102584	14,95	D102579	24,26
CRF 250 R	14-15	D102601	19,72	DMX05957	15,80
CRF 250 X	04-13	D102414	11,06	D102412	9,80
CRF 450 R	02-07	D102414	11,06	D102545	16,17
CRF 450 R	2008	D102414	11,06	D102550	16,17
CRF 450 R	09-12	D102577	24,50	D102579	24,26
CRF 450 R	13-14	D102590	23,52	D102579	24,26
CRF 450 X	05-12	D102414	11,06	D102515	17,27

HUSABERG	Año	Acelerador	P.V.P.	Embrague	P.V.P.
TE 250	2011	D110056	12,74		
TE 250	2013	D110152	12,60		
TE 300	2011	D110056	12,74		
TE 300	2013	D110152	12,60		

HUSQVARNA	Año	Acelerador	P.V.P.	Embrague	P.V.P.
CR 125	00-07			D110065	21,93
CR 125	09-12	D110062	13,44		
WR 125	00-07			D110065	21,93
WRE 125	04-05			D110065	21,93
WR 125	09-12	D110062	13,44		
TC 250	08-10	D110125			
WR 250	08-14			D110150	28,66
WR 300	09-12	D110134	9,66	D110150	28,66
WR 300	13-14			D110150	28,66
TC 449	11-12	D110148	28,66		
TXC 449	2011	D110148	28,66		
TXC 511	11-12	D110148	28,66		

KAWASAKI	Año	Acelerador	P.V.P.	Embrague	P.V.P.
KX 125	00-02	D103189	8,82	D103308	12,32
KX 125	2003	D103189	8,82	D103330	12,88
KX 125	04-05	D103189	8,82	D103346	11,76
KX 250	99-04	D103189	8,82	D103304	12,88
KX 250	05-07	D103357	9,24	D103356	9,24
KX 250 F	05-08	D103365	19,11	D103359	11,39
KX 250 F	09-10	D103365	19,11	D103394	15,93
KX 250 F	11-12	D103428	29,03	D103427	14,70
KX 250 F	13-14	D103430	19,97	D103427	14,70
KX 450 F	06-08	D103365	19,11	D103367	13,72
KX 450 F	09-12	D103396	18,01	D103400	13,60
KX 450 F	13-14	D103430	19,97	D103400	13,60
KLX 450	08-09	D103365	19,11	D103378	

SUZUKI	Año	Acelerador	P.V.P.	Embrague	P.V.P.
RM 125	04-07	D104208	10,43	D104244	9,24
RM 125	2008	D104208	10,43	D104244	9,24
RM 250	04-08	D104208	10,43	D104244	9,24
RMZ 250	05-06	D103358	17,52	D103359	11,39
RMZ 250	07-09	D104278	18,01	D104264	11,06
RMZ 250	10-12	D104278	18,01	D104319	16,78
RMZ 250	2013	D104341	33,32	D104338	13,44
RMZ 250	2014	D104341	33,32		
RMZ 450	05-06	D103348	21,68	D104252	10,22
RMZ 450	2007	D104278	18,01	D104252	10,22
RMZ 450	08-09	D104278	18,01	D104280	17,89
RMZ 450	10-12	D104278	18,01	D104280	17,89
RMZ 450	13-14	D104339	34,06	D104280	17,89
RMX 450	2010	D104278	18,01	D104320	14,95



Los cables cuya referencia es **AZUL** son 7cm más largos

YAMAHA	Año	Acelerador	P.V.P.	Embrague	P.V.P.
YZ 125	2004	D105236	11,20	D105307	14,00
YZ 125	05-06	D105236	11,20	D105401	13,86
YZ 125	07-14	D105355	14,09	D105401	13,86
YZ 125	2015			DMX05964	11,20
WR 250 F	03-06	D105286	23,64	D105295	11,76
WR 250 F	07-13	D105396	23,15	D105295	11,76
WR 250 R	08-14	D105388	26,18	D105389	13,02
WR 250 X	08-11	D105388	26,18	D105389	13,02
YZ 250	00-03	D105237	13,35	D105234	11,90
YZ 250	2004	D105237	13,35	D105309	8,54
YZ 250	2005	D105237	13,35	D105357	13,44
YZ 250	06-14	D105355	14,09	D105357	13,44
YZ 250	2015			DMX05964	11,20
YZ 250 F	01-02	D105238	21,07	D105239	12,32
YZ 250 F	2003	D105286	23,64	D105291	11,20
YZ 250 F	04-05	D105286	23,64	D105311	10,22
YZ 250 F	06-08	D105396	23,15	D105331	13,16
YZ 250 F	09-13	D105396	23,15	D105392	13,60
YZ 250 F	14-15	DMX05960	31,24	DMX05958	22,79
WR 450 F	03-06	D105286	23,64	D105293	19,60
WR 450 F	07-11	D105396	23,15	D105353	13,44
WR 450 F	12-14	D105409	35,16	D105410	20,09
YZ 450 F	04-05	D105286	23,64	D105311	10,22
YZ 450 F	06-08	D105286	23,64	D105333	9,24
YZ 450 F	2009	D105286	23,64	D105385	13,43
YZ 450 F	10-13	D105397	43,73	D105395	18,74
YZ 450 F	14-15	DMX05961	31,24	D105414	20,34

KTM	Año	Acelerador	P.V.P.
125 EXC	98-01	D110056	12,74
125 EXC	2002	D110056	12,74
125 EXC	03-04	D110056	12,74
125 EXC	2005	D110056	12,74
125 SX	11-12	D110056	12,74
125 SX	2013	D110152	12,60
250 EXC-F	2007	D110110	19,97
250 SX-F	05-12	D110110	19,97
250 SXS-F	06-08	D110110	19,97
250 XC-F	09-12	D110110	19,97
250 XCF-W	06-12	D110110	19,97
250 EXC	03-04	D110056	12,74
250 EXC	2005	D110056	12,74
250 SX	2013	D110152	12,60
250 SXF	05-12	D110111	18,01
250 SXF	05-12	D110122	17,40
250 SXF	13-14	D110151	20,46
250 XC	06-12	D110056	12,74
250 XCF	07-09	D110111	18,01
250 XCF	11-12	D110111	18,01
250 XCF	13-14	D110151	20,46
250 XCF-W	13-14	D110151	20,46
300 XC	06-12	D110056	12,74
350 EXC-F	2012	D110111	18,01
350 EXC-F	13-14	D110151	20,46
350 SX-F	11-12	D110110	19,97
350 SX-F	13-14	D110151	20,46
350 XC-F	11-12	D110110	19,97
350 XC-F	13-14	D110151	20,46
350 XCF-W	13-14	D110151	20,46
450 EXC-R	2008	D110110	19,97
450 SX-F	07-12	D110110	19,97
450 SXS-F	07-08	D110110	19,97
450 EXC-G	03-04	D110117	25,60
450 EXC-R	08-11	D110111	18,01
450 SX-F	07-12	D110111	18,01
450 SX-F	13-14	D110151	20,46
450 XC-F	06-07	D110117	25,60
450 XC-F	08-09	D110111	18,01
450 XC-F	13-14	D110151	20,46
450 XC-F WCE	2010	D110111	18,01
450 XC-W	13-14	D110151	20,46
500 EXC	2012	D110110	19,97
500 EXC	13-14	D110151	20,46
500 XC-W	2012	D110110	19,97
525 EXC-G	2004	D110117	25,60
525 EXC-G	2005	D110117	25,60
525 EXC-G	2006	D110117	25,60
525 MXC-G	03-05	D110117	25,60
525 SX	03-06	D110117	25,60
525 XC	2007	D110117	25,60
525 XC-G	2006	D110117	25,60
525 XC-W	2007	D110117	25,60
530 EXC	09-11	D110110	19,97
530 EXC-R	2008	D110110	19,97
530 XCR-W	2008	D110110	19,97
530 EXC	09-11	D110111	18,01
530 EXC	09-11	D110122	17,40
530 EXC CE	2010	D110111	18,01
530 EXC CE	2010	D110122	17,40
530 EXC-R	2008	D110111	18,01
530 EXC-R	2008	D110122	17,40
530 XC RW	2008	D110111	18,01
530 XC RW	2008	D110122	17,40
530 XC W	2009	D110111	18,01
530 XC W	2009	D110122	17,40
530 XC WSD	10-11	D110111	18,01
530 XC WSD	10-11	D110122	17,40



RUEDAS Y NEUMÁTICOS

MOTOR

ADMISIÓN / ESCAPE
REFRIGERACIÓN

ELECTRICO

SUSPENSIÓN / DIRECCIÓN

FRENOS

TRANSMISIÓN

CONTROLES Y MANDOS

CHASIS

ACCESORIOS

CONTROLES Y MANDOS



Soportes de maneta embrague



DMX083591A



DMX083591B



DMX08369
DMX083691



DMC08163
DMC081631
DMC08163B "Negra"

HONDA	FUNDICIÓN				FORJADA	
	Año	Descripción	Referencia	P.V.P.	Referencia	P.V.P.
CR 125 R	96-03	embrague	DMX08369	6,86	DMX083691	13,66
CR 125 R	04-07	embrague			DMX083591B	20,34
CR 250 R	97-03	embrague	DMX08369	6,86	DMX083691	13,66
CR 250 R	04-07	embrague			DMX083591B	20,34
CRF 250	04-09	embrague			DMX083591A	27,20
CRF 250	10-14	embrague			DMX083591B	20,34
CRF 450	04-08	embrague			DMX083591A	27,20
CRF 450	09-14	embrague			DMX083591B	20,34



D54221

KAWASAKI	FUNDICIÓN				FORJADA	
	Año	Descripción	Referencia	P.V.P.	Referencia	P.V.P.
KX 65	00-14	embrague	DMC08163	7,60	DMC081631	13,66
KX 80	98-14	embrague	DMC08163	7,60	DMC081631	13,66
KX 85	98-14	embrague	DMC08163	7,60	DMC081631	13,66
KX 100	98-14	embrague	DMC08163	7,60	DMC081631	13,66
KX 125	90-05	embrague	DMC08163	7,60	DMC081631	13,66
KX 250	90-04	embrague	DMC08163	7,60	DMC081631	13,66
KX 500	91-04	embrague	DMC08163	7,60	DMC081631	13,66



DMC08554

SUZUKI	FUNDICIÓN				FORJADA	
	Año	Descripción	Referencia	P.V.P.	Referencia	P.V.P.
RM 125	96-06	embrague	DMC08554	7,60		
RM 125	98-02	embrague			D54221	13,60
RM 250	96-06	embrague	DMC08554	7,60		
RM 250	98-02	embrague			D54221	13,60



DMC08149
DMC081491
DMC08149B "Negra"

YAMAHA	FUNDICIÓN				FORJADA	
	Año	Descripción	Referencia	P.V.P.	Referencia	P.V.P.
YZ 80	91-94	embrague	DMC08149	7,60	DMC081491	13,66
YZ 85	02-14	embrague	DMC08149	7,60	DMC081491	13,66
TT-R 125	00-04	embrague	DMC08149	7,60	DMC081491	13,66
TT-R 125	00-04	embrague	DMC08149	7,60	DMC081491	13,66
TT-T 125	03-04	embrague	DMC08149	7,60	DMC081491	13,66
YZ 125	84-99	embrague	DMC08149	7,60	DMC081491	13,66
YZ 125	00-03	embrague	DMC08199	10,78	DMC081991	17,44
WR 250	91-97	embrague	DMC08149	7,60	DMC081491	13,66
WR 250 F	01-02	embrague	DMC08199	10,78	DMC081991	17,44
YZ 250	84-99	embrague	DMC08149	7,60	DMC081491	13,66
YZ 250	00-03	embrague	DMC08199	10,78	DMC081991	17,44
YZ 250 F	01-03	embrague	DMC08199	10,78	DMC081991	17,44
YZ 250 F	09-14	embrague			DMX08455	36,58
WR 400 F	98-99	embrague	DMC08149	7,60	DMC081491	13,66
WR 400 F	2000	embrague	DMC08199	10,78	DMC081991	17,44
YZ 400 F	98-99	embrague	DMC08149	7,60	DMC081491	13,66
WR 426 F	01-02	embrague	DMC08199	10,78	DMC081991	17,44
YZ 426	00-02	embrague	DMC08199	10,78	DMC081991	17,44
YZ 450 F	2003	embrague	DMC08199	10,78	DMC081991	17,44
YZ 450 F	09-14	embrague			DMX08455	36,58



DMC08199
DMC081991
DMC08199B "Negra"



DMX08455



Manetas plegables

Manetas forjadas y plegables para minimizar los riesgos de rotura.

P.V.P
39



HONDA	Año	Referencia Freno	Referencia Embrague
CR 80	92-03	DMX08421	DMX08429
CR 80	04-07	DMX08421	
CR 85	92-07	DMX08421	DMX08429
CR 85	08-10		DMX08429
CR 125	92-03	DMX08421	DMX08429
CR 125	04-07	DMX08421	DMX08429
CR 125 R	04-07		DMX08430
CRF 150	07-14	DMX08421	DMX08429
XR 200 R	82-03	DMX08421	
CR 250	1991		DMX08429
CR 250	92-03	DMX08421	DMX08429
CR 250	04-07	DMX08421	DMX08429
CR 250 R	04-07		DMX08430
CRF 250 R	02-06	DMX08421	DMX08430
CRF 250 R	07-14	DMX08427	DMX08430
CRF 250 X	04-09	DMX08421	DMX08430
CRF 250 X	10-14	DMX08421	
XR 250 R	82-03	DMX08421	
XR 400 R	82-14	DMX08421	
CRF 450 R	02-03	DMX08421	
CRF 450 R	04-06	DMX08421	DMX08430
CRF 450 R	07-14	DMX08427	DMX08430
CRF 450 X	04-14	DMX08421	DMX08430
CR 500	91-03		DMX08429
XR 650 R	82-14	DMX08421	

KAWASAKI	Año	Referencia Freno	Referencia Embrague
KX 60	00-14	DMX08422	
KX 65	00-14	DMX08422	
KX 80	97-14		DMX08431
KX 85	97-99		DMX08431
KX 85	00-14	DMX08422	DMX08431
KX 100	97-99		DMX08431
KX 100	00-14	DMX08422	DMX08431
KX 125	98-99		DMX08431
KX 125	00-05	DMX08422	DMX08431
KX 125	06-09	DMX08422	
KLX 125	04-14	DMX08422	
KDX 200	00-14	DMX08422	
KX 250	94-99		DMX08431
KX 250	00-04	DMX08422	DMX08431
KX 250	05-07	DMX08422	DMX08433
KX 250	08-09	DMX08422	
KX 250 F	2004	DMX08422	DMX08431
KX 250 F	04-14	DMX08422	DMX08433
KX 250 F	2015	DMX08422	
KLX 250 DISC	04-14	DMX08422	
KX 450 F	06-12	DMX08422	DMX08433
KX 450 F	13-14		DMX08433
KLX 450	08-14	DMX08422	
KX 500	94-04		DMX08431

KTM	Año	Referencia Freno	Referencia Embrague
65 SX	2001	DMX08423	
65 SX	02-03	DMX08423	DMX08436
65 SX	04-12	DMX08424	DMX08436
65 SX	2013		DMX08436
65 XC	08-09		DMX08436
85 SX	04-12	DMX08424	DMX08436
85 SX	2013		DMX08436
105 SX	04-11	DMX08424	DMX08436
105 SX	2012	DMX08424	
105 XC	08-10		DMX08436
125 EXC	00-03		DMX08436
125 SX	98-99	DMX08423	
125 SX	00-08	DMX08423	DMX08436
125 SX	09-13	DMX08423	
125 XC-F	98-08	DMX08423	
125 XC-W	98-08	DMX08423	
144 SX	07-08		DMX08436
150 SX	98-13	DMX08423	
200 EXC	98-99	DMX08423	
200 EXC	00-05	DMX08423	DMX08436
200 EXC	06-13	DMX08423	
200 MXC	00-04		DMX08436
200 SX	00-04		DMX08436
200 XC-F	98-08	DMX08423	
200 XC-W	98-08	DMX08423	DMX08436
250 EXC	98-99	DMX08423	
250 EXC	00-05	DMX08423	DMX08436
250 MXC	98-99	DMX08423	
250 MXC	00-05	DMX08423	DMX08436
250 SX	98-99	DMX08423	
250 SX	00-05	DMX08423	DMX08436
250 SX	06-13	DMX08423	DMX08442
250 SX	2014		DMX08442
250 SX-F	04-06	DMX08423	
250 SX-F	07-14	DMX08423	DMX08442
250 XC	98-05	DMX08423	
250 XC	06-14		DMX08442
250 XC-F	98-05	DMX08423	
250 XC-F	07-09		DMX08442
250 XC-F	11-14		DMX08442
250 XC-W	98-05	DMX08423	
250 XC-W	06-07		DMX08442
250 XC-W	08-14		DMX08442
250 XCF	04-14	DMX08423	
250 XCF-W	04-06	DMX08423	
250 XCF-W	07-14	DMX08423	DMX08442
300 EXC	98-99	DMX08423	
300 EXC	00-05	DMX08423	DMX08436
300 MXC	98-05	DMX08423	
300 SX	98-05	DMX08423	
300 XC	98-05	DMX08423	

RUEDAS Y NEUMÁTICOS

MOTOR

ADMISIÓN / ESCAPE
REFRIGERACIÓN

ELÉCTRICO

SUSPENSIÓN / DIRECCIÓN

FRENOS

TRANSMISIÓN

CONTROLES Y MANDOS

CHASIS

ACCESORIOS



Manetas plegables

300 XC	06-13	DMX08423	DMX08442
300 XC	2014		DMX08442
300 XC-F	98-05	DMX08423	
300 XC-W	98-05	DMX08423	
300 XC-W	06-14		DMX08442
300 WC-W	06-13	DMX08423	
350 EXC-F	12-14		DMX08442
350 SX	10-13	DMX08423	
350 SX-F	11-14		DMX08442
350 XCF-W	11-14		DMX08442
350 XCF-W	12-14		DMX08442
380 EXC/SX	00-02		DMX08436
400 EXC 4T	00-07		DMX08436
400 SX 4T	00-02		DMX08436
400 SX-F	98-08	DMX08423	
400 XC	98-08	DMX08423	
400 XC-F	98-14	DMX08423	
400 XC-W	98-06	DMX08423	
400 XC-W	2007	DMX08423	DMX08436
400 XC-W	09-10	DMX08423	DMX08442
400 XC-W	11-14	DMX08423	
450 EXC	98-02	DMX08423	
450 EXC	03-06	DMX08423	DMX08436
450 EXC	2007	DMX08423	DMX08442
450 EXC	08-14	DMX08423	
450 EXC-R	08-11		DMX08442
450 MXC 4T	03-05		DMX08436
450 SX 4T	03-06		DMX08436
450 SX-F	98-06	DMX08423	
450 SX-F	07-08	DMX08423	DMX08436
450 SX-F	09-12	DMX08423	
450 SX-F	2013	DMX08423	DMX08442
450 SX-F	2014		DMX08442
450 XC	98-08	DMX08423	
450 XC-F	98-05	DMX08423	
450 XC-F	06-09	DMX08423	DMX08436
450 XC-F	10-12	DMX08423	
450 XC-F	13-14	DMX08423	DMX08442
450 XC-W	98-07	DMX08423	
450 XC-W	08-14	DMX08423	DMX08442
500 EXC	12-14		DMX08442
500 XC-W	12-14		DMX08442
505 SX-F	98-06	DMX08423	
505 SX-F	07-08	DMX08423	DMX08436
505 XC	98-08	DMX08423	
505 XC-F	98-07	DMX08423	
505 XC-F	08-09	DMX08423	DMX08442
505 XC-F	10-13	DMX08423	
505 XC-W	98-14	DMX08423	
520 EXC	00-02		DMX08436
520 MXC	00-02		DMX08436
520 SX	00-02		DMX08436
525 EXC	98-14	DMX08423	
525 EXC	03-14	DMX08423	
525 EXC 4T	03-06		DMX08436
525 EXC 4T	05-06		DMX08442
525 MXC 4T	03-05		DMX08436
525 SX	98-08	DMX08423	
525 SX 4T	03-06		DMX08436
525 XC-F	98-05	DMX08423	
525 XC-F	06-07	DMX08423	DMX08436
525 XC-F	08-14	DMX08423	
525 XC-W	98-14	DMX08423	
530 EXC	98-14	DMX08423	

SUZUKI	Año	Referencia Freno	Referencia Embrague
RM 65	03-14	DMX08422	
RM 85	96-01	DMX08421	
RM 85	02-04	DMX08425	DMX08432
RM 85	03-13	DMX08422	DMX08432
RM 85	2014	DMX08422	
RM 100	03-04		DMX08431
DRZ 125 L	04-14	DMX08422	
RM 125	86-95	DMX08425	
RM 125	96-99	DMX08421	
RM 125	00-03	DMX08421	DMX08432
RM 125	96-07	DMX08422	DMX08432
RM 125	08-09	DMX08422	
DRZ 250	04-14	DMX08422	
RM 250	86-95	DMX08425	
RM 250	96-03	DMX08421	
RM 250	96-99	DMX08422	
RM 250	00-08	DMX08422	DMX08432
RM 250	2009	DMX08422	
RM 250	09-14	DMX08422	
RMZ 250	05-06		DMX08433
RMZ 250	07-13		DMX08431
RM 450	03-04	DMX08422	
RM 450	2005	DMX08422	DMX08433
RM 450	06-13	DMX08422	DMX08431
RM 450	2014	DMX08422	

YAMAHA	Año	Referencia Freno	Referencia Embrague
YZ 80	94-00		DMX08432
YZ 80	01-14	DMX08422	DMX08432
YZ 85	94-00		DMX08432
YZ 85	01-14	DMX08422	DMX08432
TTR 125	1999	DMX08426	
TTR 125	00-14	DMX08426	DMX08432
YZ 125	94-99		DMX08432
YZ 125	00-14		DMX08433
YZ 125	01-07	DMX08422	DMX08433
YZ 125	08-14	DMX08428	DMX08433
TT-R 230	99-14	DMX08422	
TTR 250	N/A	DMX08426	
WR 250	00-02		DMX08433
WR 250	03-07		DMX08438
WR 250 F	02-03	DMX08422	
WR 250 F	04-14	DMX08422	
YZ 250	94-99		DMX08432
YZ 250	01-07	DMX08422	DMX08433
YZ 250	08-14	DMX08428	DMX08433
YZ 250 F	01-06	DMX08422	DMX08433
YZ 250 F	07-14	DMX08428	DMX08433
WR 400 F	02-03	DMX08422	
WR 426 F	01-02	DMX08422	
YZ 426 F	01-02	DMX08422	DMX08433
WR 426 F	00-02		DMX08433
WR 450 F	03-07		DMX08438
WR 450 F	04-07	DMX08422	DMX08438
WR 450 F	08-14	DMX08422	
YZ 450 F	03-08	DMX08422	DMX08433
YZ 450 F	09-14	DMX08428	



Manetas fundición y forjadas

Manetas de fundición a un precio inigualable. Las manetas forjadas son de calidad similar o superior a las originales, y no se rompen con facilidad, pudiendo enderezar la maneta sin llegar a la rotura.



HONDA	FUNDICIÓN					FORJADA			
	Año	Embrague	P.V.P.	Freno	P.V.P.	Embrague	P.V.P.	Freno	P.V.P.
CRF50F	04-15			DMP08000	4,59				
XR 50 R	00-03			DMP08000	4,59				
CRF 70 F	04-12	DAT08100	5,30	DMX08603	5,82				
XR 70 R	97-03	DAT08100	5,30	DMX08603	5,82				
CR 80 R	86-95	DMC08090B	4,90	DMC08081	5,40	DMC080901	8,20	DMC080811	5,41
CR 80 R	96-97	DMC08175	4,30			DMC081751	8,20		
CR 80 R	98-02	DMC08175	4,30	DMC08174	4,90	DMC081751	8,20	DMC081741	8,40
CRF 80 F	04-11	DAT08100	5,30						
XR 80 R	96-03	DAT08100	5,30	DMC08174	4,90			DMC081741	8,40
CR 85 R	03-08	DMC08175	4,30	DMC08174	4,90	DMC081751	8,20	DMC081741	8,40
CRF 100 F	04-12	DMC08175	4,30	DMC08174	4,90	DMC081751	8,20	DMC081741	8,40
XR 100 R	96-03	DMX08358	5,30						
CR 125 R	96-03	DMC08175	4,30	DMC08174	4,90	DMC081751	8,20	DMC081741	8,40
CR 125 R	04-07	DMX08359	4,70	DMC08174	4,90	DMX083591	8,30	DMC081741	8,40
CRF 150 F	03-15	DMX08361	5,80	DMC08174	4,90			DMC081741	8,40
CRF 150 R	08-14	DMC08175	4,30	DMC08174	4,90	DMC081751	8,20	DMC081741	8,40
XR 200 R	96-01			DMC08174	4,90			DMC081741	8,40
CRF 230 F	03-15	DMX08361	5,80	DMC08174	4,90			DMC081741	8,40
CR 250 R	96-03	DMC08175	4,30	DMC08174	4,90	DMC081751	8,20	DMC081741	8,40
CR 250 R	04-07	DMX08359	4,70	DMC08174	4,90	DMX083591	8,30	DMC081741	8,40
CRF 250 R	04-06	DMX08359	4,70	DMC08174	4,90	DMX083591	8,30	DMC081741	8,40
CRF 250 R	07-15	DMX08394	4,90	DMX083921	10,40	DMX083941	8,80	DMX08392	16,00
CRF250 X	04-12	DMX08359	4,70	DMC08174	4,90	DMX083591	8,30	DMC081741	8,40
XR 250 R	96-04	DMC08175	4,30	DMC08174	4,90	DMC081751	8,20	DMC081741	8,40
XR 400 R	96-04	DMC08175	4,30	DMC08174	4,90	DMC081751	8,20	DMC081741	8,40
CRF 450 R	02-03	DMC08175	4,30	DMC08174	4,90	DMC081751	8,20	DMC081741	8,40
CRF 450 R	04-06	DMX08359	4,70	DMC08174	4,90	DMX083591	8,30	DMC081741	8,40
CRF 450 R	07-14	DMX08394	4,90	DMX083921	10,40	DMX083941	8,80	DMX08392	16,00
CRF 450 X	05-14	DMX08359	4,70	DMC08174	4,90	DMX083591	8,30	DMC081741	8,40
CR 500 R	96-01	DMC08175	4,30	DMC08174	4,90	DMC081751	8,20	DMC081741	8,40
XR 650 R	00-07	DMC08175	4,30	DMC08174	4,90	DMC081751	8,20	DMC081741	8,40

HUSABERG	FUNDICIÓN					FORJADA			
	Año	Embrague	P.V.P.	Freno	P.V.P.	Embrague	P.V.P.	Freno	P.V.P.
todas	89-97	DMX08407	6,31						
todas	98-08	DMX08408	8,39						
TE 250	11-13			DMX084076				DMX08398	11,70
FE 250	2014			DMX08382	12,80			DMX083821	19,54
TE 250	2014			DMX08382	12,80			DMX083821	19,54
TE 300	11-13			DMX084076				DMX08398	11,70
TE 300	2014			DMX08382	12,80			DMX083821	19,54
FE 350	2014			DMX08382	12,80			DMX083821	19,54
FE 390	10-11			DMX084076		DMX08457	21,30	DMX08398	11,70
FE 450	04-06	DMX08318 larga DMX08444 corta	8,20			DMX083181 larga	13,50		
FE 450	07-08	DMX08318 larga DMX08444 corta	8,20	DMX084051	10,30	DMX083181 larga	13,50	DMX08405	14,60
FE 450	09-13			DMX084076		DMX08457	21,30	DMX08398	11,70
FE 450	2014			DMX08382	12,80			DMX083821	19,54
FX 450	2010			DMX084076		DMX08457	21,30	DMX08398	11,70
FE 501	2004	DMX08318 larga DMX08444 corta	8,20	DMX084051	10,30	DMX083181 larga	13,50	DMX08405	14,60
FE 501	2014			DMX08382	12,80			DMX083821	19,54
FE 550	04-05	DMX08318 larga DMX08444 corta	8,20	DMX084051	10,30	DMX083181 larga	13,50	DMX08405	14,60
FC 550	04-06	DMX08318 larga DMX08444 corta	8,20			DMX083181 larga	13,50		
FC550	2007	DMX08318 larga DMX08444 corta	8,20	DMX084051	10,30	DMX083181 larga	13,50	DMX08405	14,60
FE 550	2008	DMX08318 larga DMX08444 corta	8,20	DMX084051	10,30	DMX083181 larga	13,50	DMX08405	14,60
FE 570	09-10			DMX084076		DMX08457	21,30	DMX08398	11,70
FS 570	10-11								
FE 570	2011			DMX084076				DMX08398	11,70
FE 570 S	2011			DMX084076		DMX08457	21,30	DMX08398	11,70

CONTROLES Y MANDOS



Manetas fundición y forjadas

Manetas de fundición a un precio inigualable. Las manetas forjadas son de calidad similar o superior a las originales, y no se rompen con facilidad, pudiendo enderezar la maneta sin llegar a la rotura.



FE 650	04-06	DMX08318 larga DMX08444 corta	8,20			DMX083181 larga	13,50		
FS 650	04-08	DMX08318 larga DMX08444 corta	8,20			DMX083181 larga	13,50		
FE 650	04-08	DMX08318 larga DMX08444 corta	8,20	DMX084051	10,30	DMX083181 larga	13,50	DMX08405	14,60

HUSQVARNA	Año	Embrague	FUNDICIÓN			FORJADA			
			P.V.P.	Freno	P.V.P.	Embrague	P.V.P.	Freno	P.V.P.
ALLMODELS	95-00	DMX08407	6,31						
	06-08								
WRE 125	98-07	DMX08407	6,31						
CR 125	98-99	DMX08407	6,31						
CR 125	99-09			DMX084076				DMX08398	11,70
SM 125	98-99	DMX08407	6,31						
SMS 125	00-07	DMX08407	6,31						
WR 125	98-09	DMX08407	6,31						
WR 125	06-10			DMX084076				DMX08398	11,70
CR 250	98-04	DMX08407	6,31						
SMR 250	2006	DMX08408	8,39						
SMR 250	2007	DMX08407	6,31						
TC 250	03-10	DMX08408	8,39						
TC 250	2004	DMX08407	6,31						
TC 250	05-06	DMX08407	6,31	DMX084076				DMX08398	11,70
TC 250	07-08	DMX08407	6,31						
TC 250	10-11	DMX08397	16,97			DMX083971	11,70		
TE 250	2004	DMX08407	6,31						
TE 250	05-09	DMX08407	6,31	DMX084076				DMX08398	11,70
TE 250	10-11	DMX08397	16,97	DMX084076		DMX083971	11,70	DMX08398	11,70
TXC 250	10-11	DMX08397	16,97			DMX083971	11,70		
WR 250	98-02	DMX08407	6,31						
WR 250	07-			DMX084076				DMX08398	11,70
WR 300	09-11			DMX084076				DMX08398	11,70
TE 310	2008	DMX08408	8,39						
TXC 310	2008	DMX08408	8,39						
SMR 310	08-09	DMX08408	8,39						
TE 310	09-10	DMX08407	6,31	DMX084076				DMX08398	11,70
TE 310	2011	DMX08397	16,97	DMX084076				DMX08398	11,70
WR 360	99-02	DMX08407	6,31						
TE 400	2001	DMX08407	6,31						
SMR 400	04-07	DMX08407	6,31						
SMR 449	2011	DMX08397	16,97			DMX083971	11,70		
TC 449	2011	DMX08397	16,97			DMX083971	11,70		
TE 449	2011	DMX08397	16,97	DMX084076		DMX083971	11,70	DMX08398	11,70
TXC 449	2011	DMX08397	16,97	DMX084076		DMX083971	11,70	DMX08398	11,70
SMR 450	03-06	DMX08408	8,39						
SMR 450	04-10	DMX08407	6,31						
SMR 450 R	2009	DMX08407	6,31						
SMRR 450	2006	DMX08408	8,39						
TC 450	2004	DMX08407	6,31						
TC 450	05-06	DMX08407	6,31	DMX084076				DMX08398	11,70
TC 450	07-10	DMX08407	6,31						
TE 450	2004	DMX08407	6,31						
TE 450	05-10	DMX08407	6,31	DMX084076				DMX08398	11,70
SMR 511	2011	DMX08397	16,97	DMX084076		DMX083971	11,70		
TE 511	2011			DMX084076				DMX08398	11,70
TXC 511	2011	DMX08397	16,97	DMX084076		DMX083971	11,70	DMX08398	11,70
TE 510	2004	DMX08407	6,31						
TE 510 R	2004	DMX08407	6,31						



Manetas fundición y forjadas

Manetas de fundición a un precio inigualable. Las manetas forjadas son de calidad similar o superior a las originales, y no se rompen con facilidad, pudiendo enderezar la maneta sin llegar a la rotura.



KAWASAKI	Año	FUNDICIÓN				FORJADA			
		Embrague	P.V.P.	Freno	P.V.P.	Embrague	P.V.P.	Freno	P.V.P.
KX 60	90-03			DMX08610	5,82				
KX 65	00-15	DMC08147	4,30	DMX08384	6,60	DMC081471	8,40	DMX083841	10,80
KX 80	88-93	DMC08144	4,30	DMC08146	5,00	DMC081441	8,40		
KX 80	94-96	DMC08144	4,30	DMC08174	4,90	DMC081441	8,40	DMC081741	8,40
KX 80	1997	DMC08144	4,30			DMC081441	8,40		
KX 80	98-00	DMC08147	4,30	DMC08178	5,00	DMC081471	8,40	DMC081781	8,50
KX 85	01-09	DMC08147	4,30	DMX08384	6,60	DMC081471	8,40	DMX083841	10,80
KX 85	10-14	DMC08147	4,30	DMX08384	6,60	DMC081471	8,40	DMX083841	10,80
KX 100	95-96	DMC08144	4,30	DMC08174	4,90	DMC081441	8,40	DMC081741	8,40
KX 100	1997	DMC08144	4,30	DMC08178	5,00	DMC081441	8,40	DMC081781	8,50
KX 100	98-00	DMC08147	4,30	DMC08178	5,00	DMC081471	8,40	DMC081781	8,50
KX 100	01-14	DMC08147	4,30	DMX08384	6,60	DMC081471	8,40	DMX083841	10,80
KLX 110	02-14			DMX08610	5,82				
KLX 110 L	10-14	DMX08611	6,19						
KX 125	90-92	DMC08147	4,30	DMC08146	5,00	DMC081471	8,40	DMC081461	8,50
KX 125	93-96	DMC08147	4,30	DMC08174	4,90	DMC081471	8,40	DMC081741	8,40
KX 125	97-99	DMC08147	4,30	DMC08178	5,00	DMC081471	8,40	DMC081781	8,50
KX 125	00-05	DMC08147	4,30	DMX08384	6,60	DMC081471	8,40	DMX083841	10,80
KLX 125 (DRUM)	03-06								
KLX 125L (DISK)	03-06			DMC08146	5,00			DMC081461	8,50
KLX 140 L	08-14	DMX08611	6,19	DMC08018	5,40				
KDX 200	89-94	DMC08144	4,30	DMC08146	5,00	DMC081441	8,40	DMC081461	8,50
KDX 200	95-06	DMC08144	4,30	DMC08174	4,90	DMC081441	8,40	DMC081741	8,40
KDX 220 R	97-05	DMC08144	4,30	DMC08174	4,90	DMC081441	8,40	DMC081741	8,40
KDX 250	91-94	DMC08144	4,30	DMC08146	5,00	DMC081441	8,40	DMC081461	8,50
KX 250	90-92	DMC08147	4,30	DMC08146	5,00	DMC081471	8,40	DMC081461	8,50
KX 250	93-96	DMC08147	4,30	DMC08174	4,90	DMC081471	8,40	DMC081741	8,40
KX 250	97-99	DMC08147	4,30	DMC08178	5,00	DMC081471	8,40	DMC081781	8,50
KX 250	00-14	DMC08147	4,30			DMC081471	8,40	DMX083841	10,80
KX 250	05-07	DMX08420	4,90			DMX084201	4,91	DMX083841	10,80
KX 250 F	2004	DMC08147	4,30			DMC081471	8,40	DMX083841	10,80
KX 250 F	05-10	DMX08420	4,90			DMX084201	4,91	DMX083841	10,80
KX 250 F	2011	DMX08420	4,90			DMX084201	4,91	DMX083841	10,80
KX 250 F	2012	DMX08420	4,90			DMX084201	4,91	DMX083841	10,80
KX 250 F	13-14	DMX08420	4,90	DMX08373	7,00	DMX084201	4,91	DMX083731	11,80
KX 250 F	2015	DMX08420	4,90			DMX084201	4,91		
KLX 300 A	97-74	DMC08144	4,30	DMC08174	4,90	DMC081441	8,40	DMC081741	8,40
KLX 400 R	2002	N/A		N/A		N/A		N/A	
KX 450 F	06-08	DMX08420	4,90					DMX083841	10,80
KX 450 F	09-12	DMX08420	4,90					DMX083841	10,80
KX 450 F	13-14	DMX08420	4,90	DMX08373	7,00	DMC081471	8,40	DMX083731	11,80
KX 450 F	2015	DMX08420	4,90			DMC081471	8,40		
KX 500	90-93	DMC08147	4,30	DMC08146	5,00	DMC081471	8,40	DMC081461	8,50
KX 500	94-96	DMC08147	4,30	DMC08174	4,90	DMC081471	8,40	DMC081741	8,40
KX 500	97-03	DMC08147	4,30	DMC08178	5,00	DMC081471	8,40	DMC081781	8,50
KX 500	2004	DMC08147	4,30			DMC081471	8,40	DMX083841	10,80

KTM	Año	FUNDICIÓN				FORJADA			
		Embrague	P.V.P.	Freno	P.V.P.	Embrague	P.V.P.	Freno	P.V.P.
65 SX	02-03	DMX08318 larga DMX08444 corta	8,20	DMX08405	14,60	DMX083181 larga	13,50	DMX084051	10,30
65 SX	04-11	DMX08318 larga DMX08444 corta	8,20			DMX083181 larga	13,50		
65SX	12-13	DMX08318 larga DMX08444 corta	8,20	DMX08446	16,60	DMX083181 larga	13,50	DMX084461	21,38
65 SX	2014	DMX08602		DMX08602	16,17	DMX086021	24,56	DMX086021	24,56
65 XC	08-09	DMX08318 larga DMX08444 corta	8,20			DMX083181 larga	13,50		
85 SX	03-12	DMX08318 larga DMX08444 corta	8,20			DMX083181 larga	13,50		
85 SX	2013	DMX08318 larga DMX08444 corta	8,20	DMX08456	19,17	DMX083181 larga	13,50	DMX084561	24,56
85 SX	2014	DMX08602	16,17	DMX08602	16,17	DMX086021	24,56	DMX086021	24,56
85 XC	2008	DMX08318 larga DMX08444 corta	8,20	DMX08405	14,60	DMX083181 larga	13,50	DMX084051	10,30

CONTROLES Y MANDOS



Manetas fundición y forjadas

Manetas de fundición a un precio inigualable. Las manetas forjadas son de calidad similar o superior a las originales, y no se rompen con facilidad, pudiendo enderezar la maneta sin llegar a la rotura.



KTM	Año	FUNDICIÓN				FORJADA			
		Embrague	P.V.P.	Freno	P.V.P.	Embrague	P.V.P.	Freno	P.V.P.
105 SX	03-11	DMX08318 larga DMX08444 corta	8,20	DMX08405	14,60	DMX083181 larga	13,50	DMX084051	10,30
105 XC	08-09	DMX08318 larga DMX08444 corta	8,20	DMX08405	14,60	DMX083181 larga	13,50	DMX084051	10,30
125 EXC	94-96			DMC08000	5,00				
125 EXC	98-99	DMX08318 larga DMX08444 corta	8,20	DMC08000	5,00	DMX083181 larga	13,50		
125 EXC	00-04	DMX08318 larga DMX08444 corta	8,20	DMX08405	14,60	DMX083181 larga	13,50	DMX084051	10,30
125 EXC	2005	DMX08318 larga DMX08444 corta	8,20			DMX083181 larga	13,50	DMX08398	11,70
125 EXC	2014			DMX08382	12,80			DMX083821	19,54
125 MXC	2002	DMX08318 larga DMX08444 corta	8,20			DMX083181 larga	13,50		
125 MXC	2004	DMX08318 larga DMX08444 corta	8,20			DMX083181 larga	13,50		
125 SX	95-97			DMC08000	5,00				
125 SX	98-99	DMX08318 larga DMX08444 corta	8,20	DMC08000	5,00	DMX083181 larga	13,50		
125 SX	2000	DMX08318 larga DMX08444 corta	8,20			DMX083181 larga	13,50		
125 SX	01-04	DMX08318 larga DMX08444 corta	8,20	DMX08405	14,60	DMX083181 larga	13,50	DMX084051	10,30
125 SX	05-08	DMX08318 larga DMX08444 corta	8,20			DMX083181 larga	13,50	DMX08398	11,70
125 SX	2009					DMX084571	21,31	DMX08398	11,70
125 SX	11-13					DMX084571	21,31	DMX08398	11,70
125 SX	2014			DMX08382	12,80			DMX083821	19,54
144 SX	07-08	DMX08318 larga DMX08444 corta	8,20			DMX083181 larga	13,50	DMX08398	11,70
150 SX	09-13					DMX084571	21,31	DMX08398	11,70
150 XC	10-13					DMX084571	21,31	DMX08398	11,70
200 EXC	1997			DMC08000	5,00				
200 EXC	98-99	DMX08318 larga DMX08444 corta	8,20	DMC08000	5,00	DMX083181 larga	13,50		
200 EXC	00-04	DMX08318 larga DMX08444 corta	8,20	DMX08405	14,60	DMX083181 larga	13,50	DMX084051	10,30
200 EXC	2005	DMX08318 larga DMX08444 corta	8,20			DMX083181 larga	13,50	DMX08398	11,70
200 MXC	98-99	DMX08318 larga DMX08444 corta	8,20	DMC08000	5,00	DMX083181 larga	13,50		
200 MXC	00-03	DMX08318 larga DMX08444 corta	8,20	DMX08405	14,60	DMX083181 larga	13,50	DMX084051	10,30
200 SX	03-04	DMX08318 larga DMX08444 corta	8,20	DMX08405	14,60	DMX083181 larga	13,50	DMX084051	10,30
200 XC	06-08	DMX08318 larga DMX08444 corta	8,20			DMX083181 larga	13,50	DMX08398	11,70
200 XC	2009					DMX08457	21,30	DMX08398	11,70
200 XCW	06-08	DMX08318 larga DMX08444 corta	8,20			DMX083181 larga	13,50	DMX08398	11,70
200 XCW	09-13					DMX084571	21,31	DMX08398	11,70
200 EXC	2014			DMX08382	12,80			DMX083821	19,54
250 EXC	1994			DMC08000	5,00				
250 EXC	97-99			DMC08000	5,00				
250 EXC	1999	DMX08318 larga DMX08444 corta	8,20	DMC08000	5,00	DMX083181 larga	13,50		
250 EXC	00-04	DMX08318 larga DMX08444 corta	8,20	DMX08405	14,60	DMX083181 larga	13,50	DMX084051	10,30
250 EXC	2005	DMX08318 larga DMX08444 corta	8,20			DMX083181 larga	13,50	DMX08398	11,70
250 EXC	2014			DMX08382	12,80			DMX083821	19,54
250 EXCG	02-04	DMX08318 larga DMX08444 corta	8,20	DMX08405	14,60	DMX083181 larga	13,50	DMX084051	10,30
250 MXC	1998			DMC08000	5,00				
250 MXC	1999	DMX08318 larga DMX08444 corta	8,20	DMC08000	5,00	DMX083181 larga	13,50		
250 MXC	00-02	DMX08318 larga DMX08444 corta	8,20	DMX08405	14,60	DMX083181 larga	13,50	DMX084051	10,30
250 SX	1996			DMC08000	5,00				
250 SX	1998			DMC08000	5,00				
250 SX	1999	DMX08318 larga DMX08444 corta	8,20	DMC08000	5,00	DMX083181 larga	13,50		
250 SX	00-04	DMX08318 larga DMX08444 corta	8,20						
250 SX	2005	DMX08318 larga DMX08444 corta	8,20	DMX084051	10,30	DMX083181 larga	13,50	DMX08405	14,60
250 SX	06-13	DMX08397	16,97			DMX083181 larga	13,50	DMX08398	11,70



Manetas fundición y forjadas

Manetas de fundición a un precio inigualable. Las manetas forjadas son de calidad similar o superior a las originales, y no se rompen con facilidad, pudiendo enderezar la maneta sin llegar a la rotura.



KTM	Año	FUNDICIÓN				FORJADA			
		Embrague	P.V.P.	Freno	P.V.P.	Embrague	P.V.P.	Freno	P.V.P.
250 SX	2014					DMX083971	11,70	DMX08398	11,70
250 SXF	06-13	DMX08397	16,97	DMX08382	12,80			DMX083821	19,54
250 XC	06-13	DMX08397	16,97			DMX083971	11,70	DMX08398	11,70
250 XC	2014					DMX083971	11,70	DMX08398	11,70
250 XCF	07-09	DMX08397	16,97	DMX08382	12,80			DMX083821	19,54
250 XCF (ALL)	11-13	DMX08397	16,97			DMX083971	11,70	DMX08398	11,70
250 XCW	07-13	DMX08397	16,97			DMX083971	11,70	DMX08398	11,70
250 XCF-W	2014					DMX083971	11,70	DMX08398	11,70
FREERIDE 250 R	2014	DMX08602	16,17	DMX08382	12,80			DMX083821	19,54
300 EXC	1994			DMX08602	16,17	DMX086021	24,56	DMX086021	24,56
300 EXC	96-98			DMC08000	5,00				
300 EXC	1999	DMX08318 larga DMX08444 corta	8,20	DMC08000	5,00				
300 EXC	00-04	DMX08318 larga DMX08444 corta	8,20	DMC08000	5,00	DMX083181 larga	13,50		
300 EXC	2005	DMX08318 larga DMX08444 corta	8,20	DMX08405	14,60	DMX083181 larga	13,50	DMX084051	10,30
300 MXC	1995					DMX083181 larga	13,50	DMX08398	11,70
300 MXC	97-98			DMC08000	5,00				
300 MXC	1999	DMX08318 larga DMX08444 corta	8,20	DMC08000	5,00				
300 MXC	00-04	DMX08318 larga DMX08444 corta	8,20	DMC08000	5,00	DMX083181 larga	13,50		
300 MXC	2005	DMX08318 larga DMX08444 corta	8,20	DMX084051	10,30	DMX083181 larga	13,50	DMX08405	14,60
300 XC	06-13	DMX08397	16,97			DMX083181 larga	13,50	DMX08398	11,70
300 XCW	06-13	DMX08397	16,97			DMX083971	11,70	DMX08398	11,70
300 XC-W	2014					DMX083971	11,70	DMX08398	11,70
350 EXCF	12-13	DMX08397	16,97	DMX08382	12,80			DMX083821	19,54
350 SXF	11-13	DMX08397	16,97			DMX08404	5,57	DMX08398	11,70
350 SX-F	2014	DMX08602	16,17			DMX083971	11,70	DMX08398	11,70
350 XCF	11-13	DMX08397	16,97	DMX08602	16,17	DMX086021	24,56	DMX086021	24,56
FREERIDE 350	12-13					DMX083971	11,70	DMX08398	11,70
FREERIDE 350	2014	DMX08602	16,17	DMX08456	19,17			DMX084561	24,56
360 EXC	96-97			DMX08602	16,17	DMX086021	24,56	DMX086021	24,56
360 MXC	96-97			DMC08000	5,00				
360 SX	96-97			DMC08000	5,00				
380 EXC	00-02	DMX08318 larga DMX08444 corta	8,20	DMC08000	5,00				
380 MXC	00-01	DMX08318 larga DMX08444 corta	8,20	DMX08405	14,60	DMX083181 larga	13,50	DMX084051	10,30
380 SX 0	00-02	DMX08318 larga DMX08444 corta	8,20	DMX08405	14,60	DMX083181 larga	13,50	DMX084051	10,30
400 EXC	01-02	DMX08318 larga DMX08444 corta	8,20	DMX08405	14,60	DMX083181 larga	13,50	DMX084051	10,30
400 EXCG	2005	DMX08318 larga DMX08444 corta	8,20	DMX08405	14,60	DMX083181 larga	13,50	DMX084051	10,30
400 MXC	01-02	DMX08318 larga DMX08444 corta	8,20			DMX083181 larga	13,50	DMX08398	11,70
400 RXC	95-97			DMX08405	14,60	DMX083181 larga	13,50	DMX084051	10,30
400 SX	1997			DMC08000	5,00				
400 SX	01-02	DMX08318 larga DMX08444 corta	8,20	DMC08000	5,00				
400 XCW	2007	DMX08318 larga DMX08444 corta	8,20	DMX08405	14,60	DMX083181 larga	13,50	DMX084051	10,30
400 XCW	09-10	DMX08397	16,97			DMX083181 larga	13,50	DMX08398	11,70
440 EXC	1994					DMX083971	11,70	DMX08398	11,70
440 MXC	94-95			DMC08000	5,00				
450 EXCG	03-04	DMX08318 larga DMX08444 corta	8,20	DMC08000	5,00				
450 EXCG	05-06	DMX08318 larga DMX08444 corta	8,20	DMX08405	14,60	DMX083181 larga	13,50	DMX084051	10,30
450 EXCR	07-11	DMX08397	16,97			DMX083181 larga	13,50		
450 EXC	2014	DMX08397	16,97			DMX083971	11,70	DMX08398	11,70
450 MXCG	03-04	DMX08318 larga DMX08444 corta	8,20	DMX08382	12,80	DMX083971	11,70	DMX083821	19,54
450 MXCG	2005	DMX08318 larga DMX08444 corta	8,20	DMX08405	14,60	DMX083181 larga	13,50	DMX084051	10,30
450 SMR	04-08	DMX08318 larga DMX08444 corta	8,20			DMX083181 larga	13,50	DMX08398	11,70
450 SMR	2009					DMX083181 larga	13,50		
450 SMR	2012					DMX084571	21,31		

RUEDAS Y NEUMÁTICOS

MOTOR

ADMISIÓN / ESCAPE
REFRIGERACIÓN

ELECTRICO

SUSPENSIÓN / DIRECCIÓN

FRENOS

TRANSMISIÓN

CONTROLES Y MANDOS

CHASIS

ACCESORIOS

CONTROLES Y MANDOS



Manetas fundición y forjadas

Manetas de fundición a un precio inigualable. Las manetas forjadas son de calidad similar o superior a las originales, y no se rompen con facilidad, pudiendo enderezar la maneta sin llegar a la rotura.



KTM	Año	FUNDICIÓN				FORJADA			
		Embrague	P.V.P.	Freno	P.V.P.	Embrague	P.V.P.	Freno	P.V.P.
450 SX ATV	09-10					DMX084571	21,31		
450 SXF	03-04	DMX08318 larga DMX08444 corta	8,20			DMX084571	21,31		
450 SXF	05-07	DMX08318 larga DMX08444 corta	8,20	DMX08405	14,60	DMX083181 larga	13,50	DMX084051	10,30
450 SXF	2008	DMX08397	16,97			DMX083181 larga	13,50	DMX08398	11,70
450 SXF	09-13					DMX083971	11,70	DMX08398	11,70
450 SXF	13					DMX084571	21,31	DMX08398	11,70
450 SXF	2014	DMX08397	16,97			DMX083971	11,70	DMX08398	11,70
450 XC ATV	2009			DMX08382	12,80	DMX083971	11,70	DMX083821	19,54
450 XCF	06-07	DMX08318 larga DMX08444 corta	8,20			DMX08457	21,30		
450 XCF	2008					DMX083181 larga	13,50	DMX08398	11,70
450 XCF	2009	DMX08318 larga DMX08444 corta	8,20					DMX08398	11,70
450 XCFWCE	2010	DMX08397	16,97			DMX083181 larga	13,50	DMX08398	11,70
450 XCRW	2008	DMX08397	16,97			DMX083971	11,70	DMX08398	11,70
450 XCW	2007	DMX08318 larga DMX08444 corta	8,20			DMX083971	11,70	DMX08398	11,70
450 XCW	2009	DMX08397	16,97			DMX083181 larga	13,50	DMX08398	11,70
450 XCW	2012	DMX08397	16,97			DMX083971	11,70	DMX08398	11,70
450 XCWSD	10-12	DMX08397	16,97			DMX083971	11,70	DMX08398	11,70
500 EXC	2014	DMX08397	16,97			DMX083971	11,70	DMX08398	11,70
500 XCW	2012	DMX08397	16,97	DMX08382	12,80	DMX083971	11,70	DMX083821	19,54
500 XCW	2013	DMX08397	16,97			DMX083971	11,70		
505 XCF	2009	DMX08318 larga DMX08444 corta	8,20			DMX083971	11,70	DMX08398	11,70
520 EXC/MXC/SX	01-02	DMX08318 larga DMX08444 corta	8,20			DMX083181 larga	13,50	DMX08398	11,70
525 EXC	2003	DMX08318 larga DMX08444 corta	8,20	DMX08405	14,60	DMX083181 larga	13,50	DMX084051	10,30
525 EXC	2007			DMX08405	14,60	DMX083181 larga	13,50	DMX084051	10,30
525 EXCG	2004	DMX08318 larga DMX08444 corta	8,20					DMX08398	11,70
525 EXCG	05-06	DMX08318 larga DMX08444 corta	8,20	DMX08405	14,60	DMX083181 larga	13,50	DMX084051	10,30
525 MXCG	03-04	DMX08318 larga DMX08444 corta	8,20			DMX083181 larga	13,50	DMX08398	11,70
525 MXCG	2005	DMX08318 larga DMX08444 corta	8,20	DMX08405	14,60	DMX083181 larga	13,50	DMX084051	10,30
525 SMR	2004	DMX08318 larga DMX08444 corta	8,20			DMX083181 larga	13,50	DMX08398	11,70
525 SX	03-04	DMX08318 larga DMX08444 corta	8,20			DMX083181 larga	13,50		
525 SX	05-06	DMX08318 larga DMX08444 corta	8,20	DMX08405	14,60	DMX083181 larga	13,50	DMX084051	10,30
525 XC	2007	DMX08318 larga DMX08444 corta	8,20			DMX083181 larga	13,50	DMX08398	11,70
525 XCW	2007	DMX08318 larga DMX08444 corta	8,20			DMX083181 larga	13,50	DMX08398	11,70
530 EXC	10-11	DMX08397	16,97			DMX083181 larga	13,50	DMX08398	11,70
530 EXCCE	2010	DMX08397	16,97			DMX083971	11,70	DMX08398	11,70
530 EXCR	2008	DMX08397	16,97			DMX083971	11,70	DMX08398	11,70
530 EXCR	2009					DMX083971	11,70	DMX08398	11,70
	2008	DMX08397	16,97					DMX08398	11,70
530 XCW	2009	DMX08397	16,97			DMX083971	11,70	DMX08398	11,70
530 XCW	2010					DMX083971	11,70	DMX08398	11,70
530 XCWSD	10-11	DMX08397	16,97					DMX08398	11,70
550 MXC	1994					DMX083971	11,70	DMX08398	11,70
550 MXC	1996			DMC08000	5,00				
620 RXC	95-97			DMC08000	5,00				
620 SX	1997			DMC08000	5,00				
640 LC4 Adventure	04-07			DMC08000	5,00				
660 RFR	2007								
690 Enduro	08-10			DMX084051	10,30				
690 RFR	08-09	DMX08407	6,31	DMC08000	5,00				
950 Adventure	03-06	DMX08407	6,31	DMX08405	14,60			DMX084051	10,30
950 Super EnduroR	07-08			DMC08000	5,00				
950 Super EnduroR	2009	DMX08407	6,31	DMC08000	5,00				
950 Super Moto	2006	DMX08407	6,31	DMC08000	5,00				
990 Adventure	07-08	DMX08407	6,31	DMC08000	5,00				



Manetas fundición y forjadas

Manetas de fundición a un precio inigualable. Las manetas forjadas son de calidad similar o superior a las originales, y no se rompen con facilidad, pudiendo enderezar la maneta sin llegar a la rotura.



990 Adventure R	09-12	DMX08407	6,31
990 SMR	10-11	DMX08407	6,31
990 SMT	2010	DMX08407	6,31

SUZUKI	Año	FUNDICIÓN				FORJADA			
		Embrague	P.V.P.	Freno	P.V.P.	Embrague	P.V.P.	Freno	P.V.P.
RM 65	03-05	DMC08147	4,30	DMX08384	6,60	DMC081471	8,40	DMX083841	10,80
RM 80	86-01	D5255	4,30	D5254	4,90				
RM 85	02-04	DMC08176	5,20	D5254	4,90	DMC081761	8,50		
RM 85	05-12	DMC08176	5,20	DMX08384	6,60	DMC081761	8,50	DMX083841	10,80
RM 125	85-91	DMC08176	5,20	D5254	4,90				
RM 125	92-95	DMC08176	5,20	D5254	4,90	DMC081761	8,50		
RM 125	97-03	DMC08176	5,20	DMC08140	5,40	DMC081761	8,50	DMC081401	5,41
RM 125	04-08	DMC08176	5,20	DMX08384	6,60	DMC081761	8,50	DMX083841	10,80
DR 250 S	90-92	D5255	4,30						
DR 250 SE	93-94	D5255	4,30			D52541	4,91		
DRZ 250	01-07	DMX08371	5,60	D5254	4,90				
RM 250	85-91	D5255	4,30	D5254	4,90				
RM 250	92-95	DMC08176	5,20	D5254	4,90	DMC081761	8,50		
RM 250	97-03	DMC08176	5,20	DMC08140	5,40	DMC081761	8,50	DMC081401	5,41
RM 250	04-08	DMC08176	5,20	DMX08384	6,60	DMC081761	8,50	DMX083841	10,80
RMZ 250	89-98	D5255	4,30	D5254	4,90				
RMZ 250	2004	DMC08147	4,30	DMX08384	6,60	DMC081471	8,40	DMX083841	10,80
RMZ 250	05-06	DMC08198	4,60	DMX08384	6,60	DMC08198-1	4,60	DMX083841	10,80
RMZ 250	07-14	DMC08176	5,20	DMX08384	6,60	DMC081761	8,50	DMX083841	10,80
DR 350	90-00	D5255	4,30	D5254	4,90				
DR 350 S	90-93	D5255	4,30						
DR 350 SE	94-99	D5255	4,30						
DRZ 400 S	00-12	DMX08371	5,60	DMX08609	6,43				
DRZ 400 E	00-07	DMX08371	5,60	DMC08140	5,40			DMC081401	5,41
DRZ 400 SM	05-09			DMX08609	6,43				
RMZ 450	05-14	DMC08176	5,20	DMX08384	6,60	DMC081761	8,50	DMX083841	10,80
RMX 450	2010	DMC08176	5,20	DMX08384	6,60	DMC081761	8,50	DMX083841	10,80

YAMAHA	Año	FUNDICIÓN				FORJADA			
		Embrague	P.V.P.	Freno	P.V.P.	Embrague	P.V.P.	Freno	P.V.P.
YZ 80	97-85	DMC08176	5,20	DAT08074	4,40	DMC081761	8,50		
YZ 80	86-96	DMC08176	5,20	DMC08133	5,00	DMC081761	8,50	DMC081331	8,50
YZ 80	97-00	DMC08176	5,20	DMC08180	5,00	DMC081761	8,50	DMC081801	8,50
YZ 80	2001	DMC08176	5,20	DMX08384	6,60	DMC081761	8,50	DMX083841	10,80
YZ 85	02-15	DMC08176	5,20	DMX08384	6,60	DMC081761	8,50	DMX083841	10,80
YZ 125	94-95	DMC08176	5,20	DMC08136	5,00	DMC081761	8,50	DMC081361	8,50
YZ 125	96-99	DMC08176	5,20	DMC08180	5,00	DMC081761	8,50	DMC081801	8,50
YZ 125	2000			DMC08180	5,00			DMC081801	8,50
YZ 125	01-06	DMX08483	4,70	DMX08384	6,60	DMC08065	7,30	DMX083841	10,80
YZ 125	2007	DMX08483	4,70	DMX08384	6,60	DMC08065	7,30	DMX083841	10,80
YZ 125	08-14	DMX08483	4,70	DMX084001	7,10	DMC08065	7,30	DMX08400	11,80
YZ 125	2015	DMX08483	4,70	DMX084001	7,10			DMX08400	11,80
TTR 250	99-06	DMC08176	5,20	DMC08133	5,00	DMC081761	8,50	DMC081331	8,50
WR 250	92-96	DMC08176	5,20	DMC08136	5,00	DMC081761	8,50	DMC081361	8,50
WR 250	1997	DMC08176	5,20	DMC08180	5,00	DMC081761	8,50	DMC081801	8,50
WR 250 F	01-02	DMX08483	4,70	DMX08384	6,60	DMC08065	7,30	DMX083841	10,80
WR 250 F	03-05	DMX08404	5,57	DMX08384	6,60	DMX08395	8,40	DMX083841	10,80
WR 250 F	2006	DMX08404	5,57	DMX08384	6,60	DMX08395	8,40	DMX083841	10,80
WR 250 F	2007	DMX08404	5,57	DMX084001	7,10	DMX08395	8,40	DMX08400	11,80
WR 250 F	08-15	DMX08404	5,57	DMX084001	7,10	DMX08395	8,40	DMX08400	11,80
WR 250 R	08-14	DMC08134	4,30	DMC08133	5,00	DMC081341	7,20	DMC081331	8,50
WR 250 X	08-14	DMC08134	4,30	DMC08133	5,00	DMC081341	7,20	DMC081331	8,50
WR 250 Z	1991	DMC08176	5,20	DMC08136	5,00	DMC081761	8,50	DMC081361	8,50
YZ 250	94-95	DMC08176	5,20	DMC08136	5,00	DMC081761	8,50	DMC081361	8,50
YZ 250	96-99	DMC08176	5,20	DMC08180	5,00	DMC081761	8,50	DMC081801	8,50
YZ 250	2000			DMC08180	5,00			DMC081801	8,50
YZ 250	01-06	DMX08483	4,70	DMX08384	6,60	DMC08065	7,30	DMX083841	10,80
YZ 250	2007	DMX08483	4,70	DMX08384	6,60	DMC08065	7,30	DMX083841	10,80
YZ 250	08-14	DMX08483	4,70	DMX084001	7,10	DMC08065	7,30	DMX08400	11,80
YZ 250	2015	DMX08483	4,70	DMX084001	7,10			DMX08400	11,80



Manetas fundición y forjadas

Manetas de fundición a un precio inigualable. Las manetas forjadas son de calidad similar o superior a las originales, y no se rompen con facilidad, pudiendo enderezar la maneta sin llegar a la rotura.



YAMAHA	Año	FUNDICIÓN				FORJADA			
		Embrague	P.V.P.	Freno	P.V.P.	Embrague	P.V.P.	Freno	P.V.P.
YZ 250 F	01-05	DMX08483	4,70	DMX08384	6,60	DMC08065	7,30	DMX083841	10,80
YZ 250 F	2006	DMX08483	4,70	DMX08384	6,60	DMC08065	7,30	DMX083841	10,80
YZ 250 F	2007	DMX08483	4,70	DMX084001	7,10	DMC08065	7,30	DMX08400	11,80
YZ 250 F	2008	DMX08483	4,70	DMX084001	7,10	DMC08065	7,30	DMX08400	11,80
YZ 250 F	09-15			DMX084001	7,10	DMX08454	8,80	DMX08400	11,80
WR 400 F	1998	DMC08176	5,20	DMC08180	5,00	DMC081761	8,50	DMC081801	8,50
WR 400 F	1999	DMC08176	5,20	DMC08180	5,00	DMC081761	8,50	DMC081801	8,50
WR 400 F	2000			DMC08180	5,00			DMC081801	8,50
WR 400 F	01-02	DMX08483	4,70	DMX08384	6,60	DMC08065	7,30	DMX083841	10,80
YZ 400 F	98-99	DMC08176	5,20	DMC08180	5,00	DMC081761	8,50	DMC081801	8,50
WR 426 F	01-02	DMX08483	4,70	DMX08384	6,60	DMC08065	7,30	DMX083841	10,80
YZ 426 F	2000			DMC08180	5,00			DMC081801	8,50
YZ 426 F	01-02	DMX08483	4,70	DMX08384	6,60	DMC08065	7,30	DMX083841	10,80
WR 450 F	03-04	DMX08404	5,57	DMX08384	6,60	DMX08395	8,40	DMX083841	10,80
WR 450 F	2005	DMX08404	5,57	DMX08384	6,60	DMX08395	8,40	DMX083841	10,80
WR 450 F	06-11	DMX08404	5,57	DMX08384	6,60	DMX08395	8,40	DMX083841	10,80
WR 450 F	12-15	DMX08404	5,57			DMX08395	8,40		
YZ 450 F	03-05	DMX08483	4,70	DMX08384	6,60	DMC08065	7,30	DMX083841	10,80
YZ 450 F	06-07	DMX08483	4,70	DMX08384	6,60	DMC08065	7,30	DMX083841	10,80
YZ 450 F	2008	DMX08483	4,70	DMX084001	7,10	DMC08065	7,30	DMX08400	11,80
YZ 450 F	09-11			DMX084001	7,10	DMX08454	8,80	DMX08400	11,80



Pedales de arranque



DMX08951SL	DMX08951RD
Aluminio	Rojo
74,58	79,39

HONDA Año

CRF 250 F	12-15
-----------	-------



DMX08950SL	DMX08950RD
Aluminio	Rojo
74,58	79,39

HONDA Año

CRF 450 F	12-15
-----------	-------



DMX08953SL	DMX08953GN
Aluminio	Verde
74,58	79,39

KAWASAKI Año

KX 250 F	13-14
----------	-------



DMX08959SL	DMX08959OR
Aluminio	Naranja
74,58	79,39

KTM Año

SX 150	12-14
--------	-------



DMX08960SL	DMX08960OR
Aluminio	Naranja
74,58	79,39

KTM Año

SX 85	03-14
SXS 85	12-13
XC 85	08-09
SX 105	04-11
XC 105	08-09



DMX08958SL	DMX08958OR
Aluminio	Naranja
74,58	79,39

KTM Año

SX-F 250	2011
XC-F 250	11-12
XCF-W 250	12-14
XC 300	11-14
XC-F 350	11-12
XC-W 400	12-14



DMX08955SL	DMX08955BU
Aluminio	Azul
74,58	79,39

YAMAHA Año

YZ 250 F	10-13
----------	-------



DMX08954SL	DMX08954BU
Aluminio	Azul
74,58	79,39

YAMAHA Año

YZ 450 F	10-15
----------	-------



Pedales de cambio



DMX061321 28,00€

HONDA Año

CR80	1996-07
CR85	1996-07



DMX061131 28,00€

HONDA Año

CR125	1983-03
CR250	1984-03
CR500	1984-01



DMX061271 28,00€

HONDA Año

CR 250 R	02-03
----------	-------



DMX061331 28,00€

HONDA Año

CRF250R	2004-09
CRF250X	2004-09



DMX08097 28,00€

HONDA Año

CRF 250 R	2010-14
-----------	---------



DMX061261 28,00€

HONDA Año

CRF450R	2002-08
---------	---------



DMX08098 28,00€

HONDA Año

CRF450R	2009-12
---------	---------



DMX08082 28,00€

HONDA Año

CRF450X	2005-12
---------	---------



DMX08070 28,00€

KAWASAKI Año

KX65	2000-12
KX125	1994-02
KX250	1994-02
KX500	1994-04



DMX061051 28,00€

KAWASAKI Año

KX125	1994-02
KX250	1994-02
KX500	1994-04



DMX061151 28,00€

KAWASAKI Año

KX125	2003-09
-------	---------



DMX061251 28,00€

KAWASAKI Año

KX250F	2004-05
--------	---------



DMX08072 28,00€

KAWASAKI Año

KX250F	2006-08
--------	---------



DMX08084 28,00€

KAWASAKI Año

KX250F	2009-12
--------	---------



DMX061191 28,00€

KAWASAKI Año

KX450F	2006-08
KLX450R	2008-09



DMX08085 28,00€

KAWASAKI Año

KX450F	2009-14
--------	---------



DMX08086 28,00€

KTM Año

65SX	2009-11
------	---------



DMX061371 28,00€

KTM Año

85SX	2003-11
105SX	2004-11
125SX	2011

RUEDAS Y NEUMÁTICOS

MOTOR

ADMISIÓN / ESCAPE
REFRIGERACIÓN

ELECTRICO

SUSPENSIÓN / DIRECCIÓN

FRENOS

TRANSMISIÓN

CONTROLES Y MANDOS

CHASIS

ACCESORIOS

CONTROLES Y MANDOS



DMX08063 28,00€

KTM	Año
250 EXC SIX-DAYS	2005
250 SX	2005-08
250 SX-F	2006-10
250 SXS	2006
250 XC/XC-W	2006-11
250 XCF	2007-09
250 XCFW	2007-08
250 XCWE	2008
300 EXC/SIX-DAYS	2005
300 MXC	2005
300 XC/XC-W	2006-11



DMX061211 28,00€

KTM	Año
125 EXC/MXC/XS	2000-12
144	2007-08
150SX	2009-12
150XC	2009-12
"200EX/MXC/SX /XC/XC-W"	2001-12
250EXC	1998-07
250EXC-F	2006-08
250MXC	1998-03
250SX	1998-13
250SX-F	2005-10
250SXS	1999-05



DMX061221 28,00€

KTM	Año
400 EXC-G	2005-06
400 XCW	2007, 09-11
450 EXC/EXC-G	2005-06
450 SX/SXS	2005-06
450 SMR	2006-07
450 XC/EXCR	2007
450 XCRW	2008
450XCW	2007, 09-11
525 EXC/MXC/SX	2005-06
525 XC/XCW	2007



DMX061341 28,00€

SUZUKI	Año
KX450F	2009-14



DMX061061 28,00€

SUZUKI	Año
RM125	1993-08
RM250	1989-93



DMX061081 28,00€

SUZUKI	Año
RM250	1994-08
RMX250	1995-98



DMX061251 28,00€

SUZUKI	Año
RMZ250	2004-06



DMX08076 28,00€

SUZUKI	Año
RMZ 250	2007-10



DMX061241 28,00€

SUZUKI	Año
RMX250T/W	1989-98
DRZ400	2000-09, 11



DMX08067 28,00€

SUZUKI	Año
RMZ450	2005-07



DMX08077 28,00€

SUZUKI	Año
RMZ450	2008-12



DMX08075 28,00€

YAMAHA	Año
YZ80/85	1993-06
YZ125	1996-04
YZ250	1996-98
TTR225	1995-03



DMX061171 28,00€

YAMAHA	Año
YZ125	2005-10
YZ250	2005-10



DMX08060 28,00€

YAMAHA	Año
YZ250	1999-04



DMX08074 28,00€

YAMAHA	Año
YZ250F	2006-11
WR250F	2007-13
WR450F	2007-12



DMX061091 28,00€

YAMAHA	Año
YZ400	98-99
YZ426	00-02
WR426F	01-02
YZ450	03-04
WR450F	03-06
YZ450F	06-08



DMX08071 28,00€

YAMAHA	Año
YZ450F	2006-13



XPEED

Protector pedal de freno trasero

Referencia	P.V.P.
DMX05950	5,68

CHASIS



XPEED

Protector de aluminio para cárter

Construidos en aluminio de alta calidad, con un espesor de 45mm. Cubre totalmente el motor, garantizando la máxima protección contra impactos y proyecciones de piedras.



P.V.P
88,45

AJP	Año	Referencia
PR3 125 Enduro	2010	P59076
PR3 125 Enduro	14-15	P59076
PR3 125 Enduro Pro	2010	P59076
PR3 125 Enduro Pro	14-15	P59076
PR3 125 Supermoto	2010	P59076
PR3 125 Supermoto	14-15	P59076
PR3 125 Supermoto Pro	2010	P59076
PR3 125 Trail	2014	P59076
PR4 125 Enduro	2010	P59076
PR4 125 Enduro	14-15	P59076
PR4 125 Enduro Pro	2010	P59076
PR4 125 Enduro Pro	14-15	P59076
PR4 125 Supermoto	2010	P59076
PR4 125 Supermoto	14-15	P59076
PR4 125 Supermoto Pro	2010	P59076
PR3 200 Enduro	2010	P59076
PR3 200 Enduro Pro	2010	P59076
PR3 200 MX	2010	P59076
PR3 200 MX Pro	2010	P59076
PR3 200 Supermoto	2010	P59076
PR3 200 Supermoto Pro	2010	P59076
PR4 200 Enduro	2010	P59076
PR4 200 Enduro Pro	2010	P59076
PR4 200 Supermoto	2010	P59076
PR4 200 Supermoto Pro	2010	P59076
PR3 240 Enduro	14-15	P59076
PR3 240 Enduro Pro	14-15	P59076
PR3 240 MX Pro	14-15	P59076
PR3 240 Supermoto	14-15	P59076
PR4 240 Enduro	14-15	P59076
PR4 240 Enduro Pro	14-15	P59076
PR4 240 Extreme	14-15	P59076
PR4 240 Supermoto	14-15	P59076
PR5 250 Enduro	14-15	P59118
PR5 250 Extreme	14-15	P59118
PR5 250 Supermoto	2015	P59118

APRILIA	Año	Referencia
RXV 450	09-11	P59082
RXV 550	09-11	P59082

BETA	Año	Referencia
ALP 4.0	10-14	P59136
RE 4T 125	08-14	P59149
RR 4T 125	08-14	P59149
RR 4T 125 LC	10-15	P59127
RR 2T 250	13-15	P59116
RR 4T 250	05-07	P59023
RR 2T 300	13-15	P59116
X-Trainer 300	2015	P59150
RR 4T 350	11-15	P59080
RR 4T 350	2015	P59080
RR 4T 390	2015	P59080
RR 4T 400	05-09	P59023
RR 4T 400	10-14	P59080
RR 4T 430	2015	P59080
RR 4T 450	05-09	P59023
RR 4T 450	10-14	P59080
RR 4T 480	2015	P59080
RR 4T 498	12-14	P59080
RR 4T 520	10-11	P59080
RR 4T 525	05-09	P59023

BMW	Año	Referencia
G 450 X	09-10	P59081

GAS GAS	Año	Referencia
EC 125	01-09	P59007
EC 125	10-11	P59067
EC 125	12-13	P59123
MC 125	01-07	P59007
EC 200	00-09	P59008
EC 200	2010	P59055
EC 200	2011	P59073
EC 200	12-13	P59088
EC 250	00-09	P59008
EC 250	2010	P59055
EC 250	2011	P59073
EC 250	12-13	P59088
EC 250	14-15	P59129
EC 250F	10-11	P59052
EC 250F	12-13	P59096
MC 250	00-09	P59008
EC 300	00-09	P59008
EC 300	2010	P59055
EC 300	2011	P59073
EC 300	12-13	P59088
EC 300	14-15	P59129
EC 450F	2009	P59105
EC 450F	12-13	P59117

HONDA	Año	Referencia
CRF 150 R	07-09	P59113
CRF 150 R	12-13	P59113
CRF 230 F	07-11	P59006
CR 250 R	02-07	P59091
CRF 250 L	13-14	P59135
CRF 250 M	2014	P59135
CRF 250 R	04-09	P59005
CRF 250 R	2010	P59064
CRF 250 R	11-13	P59075
CRF 250 R	14-15	P59126
CRF 250 X	04-14	P59004
CRF 450 R	02-04	P59044
CRF 450 R	05-08	P59002
CRF 450 R	09-12	P59049
CRF 450 R	13-15	P59114
CRF 450 X	05-14	P59003

HUSABERG	Año	Referencia
TE 125	12-14	P59063
FE 250	2013	P59109
FE 250	2014	P59111A
TE 250	2012	P5969A
TE 250	13-14	P59133
TE 300	2012	P5969A
TE 300	13-14	P59133
FE 350	2013	P59084
FE 350	2014	P59111A
FE 390	10-12	P59047
FE 450	06-08	P59137
FE 450	09-12	P59047
FE 450	2013	P59137
FE 501	2013	P59137
FE 550	06-08	P59137
FE 570	09-12	P59047
FE 650	06-08	P59021

HUSQVARNA	Año	Referencia
CR 125	08-12	P59062
TE 125	2014	P59132
WR 125	08-12	P59062
FC 250	14-15	P59111A
FE 250	14-15	P59111A
TC 250	04-07	P59012
TC 250	2008	P59013
TC 250	2010	P59056
TC 250	11-13	P59078
TE 250	04-07	P59012
TE 250	08-09	P59013
TE 250	2010	P59056
TE 250	11-13	P59078
TE 250	14-15	P59133
WR 250	08-13	P59048
TE 300	14-15	P59133
WR 300	09-13	P59048
TE 310	09-10	P59013
TE 310	11-13	P59078
FC 350	14-15	P59111A
FE 350	14-15	P59111A
TC 449	11-13	P59077
TE 449	11-13	P59077
TC 450	04-17	P59012
TC 450	08-10	P59013
TE 450	04-07	P59012
TE 450	08-10	P59013
TC 510	05-07	P59012
TC 510	08-09	P59013
TE 510	04-07	P59012
TE 510	08-10	P59013
TE 510 R	2004	P59012
TE 511	11-13	P59077
TE 610	06-08	P59036

KAWASAKI	Año	Referencia
KX 85	04-08	P59112
KX 250 F	06-08	P59019
KX 250 F	2009	P59051
KX 250 F	10-16	P59065
KLX 450 R	08-15	P59001
KX 450 F	06-08	P59045
KX 450 F	09-15	P59057
KX 450 F	2016	P59152

KTM	Año	Referencia
65 SX	2014	P59130
85 SX	04-12	P59104
85 SX	13-15	P59120
85 SX	2016	P59154
125 EXC	04-07	P59040
125 EXC	08-16	P59063
125 SX	04-06	P59040
125 SX	07-11	P59063
125 SX	12-14	P59107
150 XC	12-14	P59107
200 EXC	04-07	P59040
200 EXC	08-16	P59063
200 SX	2004	P59040
200 XC-W	2016	P59063
250 EXC	01-07	P59079
250 EXC	04-07	P59035

XPEED

Protector de aluminio para cárter

**P.V.P
88,45**

250 EXC	08-10	P59037
250 EXC	2011	P5969A
250 EXC	12-16	P59133
250 EXC-F	01-03	P59032
250 EXC-F	2007	P59027
250 EXC-F	08-11	P59039
250 EXC-F	12-13	P59109
250 EXC-F	14-16	P59122A
250 SX	01-06	P59079
250 SX	04-06	P59035
250 SX	07-10	P59037
250 SX	2011	P5969A
250 SX	12-14	P59100
250 SX-F	2006	P59027
250 SX-F	07-09	P59039
250 SX-F	2010	P59074
250 SX-F	2011	P59072
250 SX-F	2012	P59090
250 SX-F	13-14	P59119
250 SX-F	2015	P59111A
250 SX-F	2016	P59151
250 XC-W	2016	P59133
250 XC-F	2016	P59151
250 XCF-W	2016	P59122A
Freerider 250 R	14-15	P59146
300 EXC	01-07	P59079
300 EXC	04-07	P59035
300 EXC	08-10	P59037
300 EXC	2011	P5969A
300 EXC	12-16	P59133
300 XC	12-14	P59100
300 XC-W	2016	P59133
350 EXC-F	12-14	P59084
350 EXC-F	15-16	P59122A
350 SX-F	11-15	P59070
350 SX-F	2016	P59151
350 XC-F	12-14	P59111A
350 XC-F	2016	P59151
350 XCF-W	2016	P59122A
400 EXC-F	01-02	P59032
400 EXC-F	04-07	P59033
400 EXC-F	09-11	P59030
400 SX-F	00-02	P59032
450 EXC-F	2003	P59032
450 EXC-F	04-07	P59033
450 EXC-F	08-11	P59030
450 EXC-F	12-16	P59137
450 SX-F	03-06	P59033
450 SX-F	07-10	P59031

450 SX-F	11-12	P59071
450 SX-F	13-14	P59137
450 SX-F	2016	P59153
450 XC-F	2016	P59153
450 XC-W	2016	P59137
500 EXC	12-16	P59137
500 XC-W	2016	P59137
505 SX-F	07-08	P59031
525 EXC Raacing	2003	P59032
525 EXC Racing	04-07	P59033
525 SX Racing	03-06	P59033
530 EXC-F	08-11	P59030

SHERCO	Año	Referencia
SE 250	14-15	P59099
SE 250R	14-15	P59099
SEF 250	12-14	P59092
SEF 250	2015	P59134
SEF 250R	12-14	P59092
SEF 250R	2015	P59134
SE 300	14-15	P59099
SE 300R	14-15	P59099
SEF 300	12-14	P59092
SEF 300	2015	P59134
SEF 300R	12-14	P59092
SEF 300R	2015	P59134

SUZUKI	Año	Referencia
RM 85	02-12	P59106
RM 85	2015	P59106
RM-Z 250	07-09	P59009
RM-Z 250	10-13	P59059
RM-Z 250	10-14	P5959A
RM-Z 250	2015	P59138
DR-Z 400	00-04	P59068
DR-Z 400 E	00-07	P59068
DR-Z 400 S	00-15	P59068
DR-Z 400 SM	05-15	P59068
RMX 450Z	10-11	P59060
RM-Z 450	05-07	P59010
RM-Z 450	08-09	P59011
RM-Z 450	10-13	P59058
RM-Z 450	10-15	P5958A

TM	Año	Referencia
EN 125	08-14	P59041
MX 125	08-14	P59041
EN 144	09-14	P59041
MX 144	08-14	P59041
EN 250	04-07	P59022

EN 250	08-10	P59038
EN 250	11-14	P59125
EN 250	2015	P59147
EN 250F	08-10	P59050
EN 250 Fi	10-14	P59050
EN 250 Fi	2015	P59148
MX 250	04-07	P59022
MX 250	08-10	P59038
MX 250	11-14	P59125
MX 250	2015	P59147
MX 250 F	08-10	P59050
MX 250 Fi	10-14	P59050
EN 300	04-07	P59022
EN 300	08-10	P59038
EN 300	11-14	P59125
EN 300	2015	P59147
MX 300	04-07	P59022
MX 300	08-10	P59038
MX 300	11-14	P59125
MX 300	2015	P59147
EN 450 F	08-10	P59050
EN 450 Fi	10-14	P59050
MX 450 F	08-10	P59050
MX 450 Fi	10-14	P59050
EN 530 F	08-14	P59050
MX 530 F	08-14	P59050

YAMAHA	Año	Referencia
YZ 85	04-15	P59110
WR 250 F	07-14	P59014
WR 250 F	2015	P59145
YZ 250	05-13	P59017
YZ 250 F	06-09	P59016
YZ 250 F	10-13	P59054
YZ 250 F	14-15	P59128
WR 450 F	03-06	P59066
WR 450 F	07-11	P59015
WR 450 F	12-15	P59098
YZ 450 F	06-19	P59018
YZ 450 F	10-13	P59061
YZ 450 F	2014	P59124

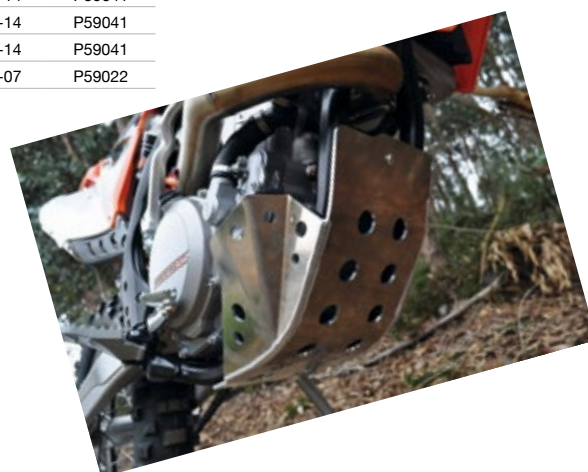

RUEDAS Y NEUMÁTICOS

MOTOR

ADMISIÓN / ESCAPE
REFRIGERACIÓN

ELÉCTRICO

SUSPENSIÓN / DIRECCIÓN

FRENOS

TRANSMISIÓN

CONTROLES Y MANDOS

CHASIS

ACCESORIOS

P.V.P
67,45

P.V.P
74,20



XPEED Protector radiador

El protector de radiador se ha diseñado especialmente para proteger su sistema de refrigeración. Asegura un perímetro de protección alrededor del radiador. Con este perímetro de seguridad los impactos no afectarán a su radiador. Fabricado en aluminio de alta calidad con un espesor de 3mm

Para colores añadir la letra correspondiente detrás de la referencia. Se entregan bajo pedido en un plazo de 3 semanas.

NEGRO	N
AZUL	B
ROJO	R
BLANCO	W
AMARILLO	Y
NARANJA	O
VERDE	G

AJP	Año	Referencia
PR5 250 Enduro	14-15	P60118
PR5 250 Extreme	14-15	P60118
PR5 250 Supermoto	2015	P60118

APRILIA	Año	Referencia
RXV 450	09-11	P60082
RXV 550	09-11	P60082

BETA	Año	Referencia
RR 2T 250	13-15	P60116
RR 4T 250	05-07	P60023
RR 2T 300	13-15	P60116
X-Trainer 300	2015	P60150
RR 4T 350	11-14	P60023
RR 4T 350 EFI	2015	P60023
RR 4T 390	2015	P60023
RR 4T 400	05-14	P60023
RR 4T 430	2015	P60023
RR 4T 450	05-14	P60023
RR 4T 480	2015	P60023
RR 4T 498	12-14	P60023
RR 4T 520	10-11	P60023
RR 4T 525	05-09	P60023

BMW	Año	Referencia
G 450 X	09-10	P60081

GAS GAS	Año	Referencia
EC 125	01-15	P60123
MC 125	02-07	P60123
EC 200	00-15	P60123
EC 250	00-15	P60123
EC 250F	10-15	P60123
MC 250	00-09	P60123
EC 300	00-15	P60123
EC 300F	13-15	P60123
EC 400F	02-03	P60123
EC 450F	03-15	P60123
EC 515F	08-09	P60123

HONDA	Año	Referencia
CRF 150R	07-09	P60113
CRF 150R	12-15	P60113
CR 250R	02-07	P60091
CRF 250L	13-14	P60135
CRF 250M	2014	P60135
CRF 250R	06-09	P60005
CRF 250R	10-13	P60064
CRF 250R	2014	P60126
CRF 250R	2015	P60143
CRF 250X	04-14	P60004

CRF 450R	05-08	P60002
CRF 450R	09-12	P60049
CRF 450R	13-14	P60114
CRF 450R	2015	P60142
CRF 450X	05-07	P6003A
CRF 450X	08-14	P60003

HUSABERG	Año	Referencia
TE 125	12-14	P60141
FE 250	13-14	P6140A
TE 250	12-14	P60141
TE 300	12-14	P60141
FE 350	13-14	P6140A
FE 450	09-12	P60087
FE 450	13-14	P6140A
FE 501	13-14	P6140A
FE 570	09-12	P60087

HUSQVARNA	Año	Referencia
CR 125	08-09	P60048
CR 125	10-13	P60056
TC 125	2014	P60141
TC 125	2015	P6140A
TE 125	2014	P60141
TE 125	2015	P6140A
WR 125	08-09	P60048
WR 125	10-13	P60056
FC 250	2014	P60141
FC 250	2015	P6140A
FE 250	14-15	P6140A
TC 250	04-07	P60012
TC 250	2008	P60013
TC 250	10-13	P60056
TC 250	2014	P60141
TC 250	2015	P6140A
TE 250	04-07	P60012
TE 250	08-09	P60013
TE 250	10-13	P60056
TE 250	2014	P60141
TE 250	2015	P6140A
WR 250	08-09	P60048
WR 250	10-13	P60056
TE 300	2014	P60141
TE 300	2015	P6140A
WR 300	2009	P60048
WR 300	10-13	P60056
TE 310	2009	P60013
TE 310	11-13	P60078
FC 350	2014	P60141
FC 350	2015	P6140A
FE 350	14-15	P6140A
TC 449	11-13	P60077

TE 449	11-13	P60077
FC 450	2014	P60141
FC 450	2015	P6140A
FE 450	14-15	P6140A
TC 450	04-07	P60012
TC 450	08-09	P60013
TE 450	04-07	P60012
TE 450	08-09	P60013
FE 501	14-15	P6140A
TC 510	05-07	P60012
TC 510	08-09	P60013
TE 510	04-07	P60012
TE 510	08-09	P60013
TE 510R	2004	P60012
TE 511	11-13	P60077
TE 610	06-08	P60036
TE 610E	2004	P60036

KAWASAKI	Año	Referencia
KX 85	04-14	P60112
KX 250 F	06-08	P60019
KX 250 F	2009	P60051
KX 250 F	10-16	P60065
KLX 450 R	08-15	P60045
KX 450 F	06-08	P60045
KX 450 F	2009	P60046
KX 450 F	10-11	P60057
KX 450 F	12-15	P60089
KX 450 F	2016	P60152

KTM	Año	Referencia
65 SX	2014	P60130
85 SX	03-16	P6120A
85 SX	04-12	P60104
85 SX	2013	P60120
125 EXC	03-07	P60024
125 EXC	08-11	P60087
125 EXC	12-16	P60141
125 SX	03-06	P60024
125 SX	07-10	P60087
125 SX	11-14	P60141
125 SX	2015	P6140A
144 SX	2008	P60087
150 SX	09-10	P60087
150 SX	11-14	P60141
150 SX	2015	P6140A
150 XC	11-14	P60141
200 EXC	03-07	P60024
200 EXC	08-11	P60087
200 EXC	12-16	P60141
200 SX	03-04	P60024
200 XC-W	15-16	P6140A



250 EXC	03-07	P60024
250 EXC	08-11	P60087
250 EXC	12-16	P60141
250 EXC-F	2007	P60024
250 EXC-F	08-11	P60087
250 EXC-F	12-16	P6140A
250 SX	03-06	P60024
250 SX	07-10	P60087
250 SX	11-14	P60141
250 SX	2015	P6140A
250 SX-F	2006	P60024
250 SX-F	07-10	P60087
250 SX-F	11-14	P60141
250 SX-F	2015	P6140A
250 SX-F	2016	P60024
250 XC	11-14	P60141
250 XC	2015	P6140A
250 XC-F	11-14	P60141
250 XC-F	2015	P6140A
250 XC-F	2016	P60151
250 XCF-W	15-16	P6140A
250 XC-W	15-16	P6140A
FREERIDE 250 R	14-15	P60146
300 EXC	03-07	P60024
300 EXC	08-11	P60087
300 EXC	12-16	P60141
300 XC	11-14	P60141
300 XC	2015	P6140A
300 XC-W	15-16	P6140A
300 XC-W SIX DAYS	15-16	P6140A
350 EXC-F	12-16	P6140A
350 SX-F	11-14	P60141
350 SX-F	2015	P6140A
350 SX-F	2016	P60151
350 XC-F	11-14	P60141
350 XC-F	2015	P6140A
350 XC-F	2016	P60151
350 XCF-W	15-16	P6140A
350 XCF-W SIX DAYS	2015	P6140A
400 EXC-F	05-07	P60033
400 EXC-F	09-11	P60087
450 EXC-F	05-07	P60033
450 EXC-F	08-11	P60087
450 EXC-F	12-16	P6140A
450 SX-F	05-06	P60033
450 SX-F	07-10	P60087
450 SX-F	11-14	P60141
450 SX-F	2015	P6140A
450 SX-F	2016	P60151
450 XC-F	13-14	P60141
450 XC-F	2015	P6140A
450 XC-F	2016	P60151

450 XC-W	15-16	P6140A
500 EXC	12-16	P6140A
500 XC-W	15-16	P6140A
505 SX-F	2008	P60087
525 EXC RACING	05-07	P60033
525 SX RACING	05-06	P60033
530 EXC-F	08-11	P60087

SHERCO	Año	Referencia
SE 250	14-15	P60099
SE 250R	14-15	P60099
SEF 250	12-14	P6092A
SEF 250	2015	P6134A
SEF 250R	12-14	P6092A
SEF 250R	2015	P6134A
SE 300	14-15	P60099
SE 300R	14-15	P60099
SEF 300	12-14	P6092A
SEF 300	2015	P6134A
SEF 300R	12-14	P6092A
SEF 300R	2015	P6134A

SUZUKI	Año	Referencia
RM 85	02-12	P60106
RM 85	2015	P60106
RM-Z 250	07-09	P60009
RM-Z 250	10-15	P6059A
DR-Z 400	00-04	P60068
DR-Z 400E	00-07	P60068
DR-Z 400S	00-15	P60068
DR-Z 400SM	05-09	P60068
DR-Z 400SM	13-15	P60068
RMX 450Z	10-11	P6058A
RM-Z 450	05-07	P60010
RM-Z 450	08-09	P60011
RM-Z 450	10-15	P6058A

TM	Año	Referencia
EN 125	04-07	P60022
EN 125	08-14	P60041
EN 125	2015	P60147
MX 125	04-07	P60022
MX 125	08-14	P60041
MX 125	2015	P60147
EN 144	09-14	P60041
EN 144	2015	P60147
MX 144	08-14	P60041
MX 144	2015	P60147
EN 250	04-07	P60022
EN 250	08-14	P60041
EN 250	2015	P60147
EN 250F	09-10	P60050
EN 250Fi	10-14	P60050

EN 250Fi	2015	P60148
MX 250	04-07	P60022
MX 250	08-14	P60041
MX 250	2015	P60147
MX 250F	09-10	P60050
MX 250Fi	10-14	P60050
EN 300	04-07	P60022
EN 300	08-14	P60041
EN 300	2015	P60147
MX 300	04-07	P60022
MX 300	08-14	P60041
MX 300	2015	P60147
EN 450F	09-10	P60050
EN 450Fi	10-14	P60050
MX 450F	09-10	P60050
MX 450Fi	10-14	P60050
EN 530F	09-14	P60050
MX 530F	09-14	P60050

YAMAHA	Año	Referencia
YZ 85	04-12	P60110
YZ 85 LW	02-15	P60110
YZ 125	05-14	P60017
WR 250 F	07-14	P60014
WR 250 F	2015	P60145
YZ 250	05-14	P60017
YZ 250 F	06-09	P60016
YZ 250 F	10-13	P6054A
YZ 250 F	14-15	P60124
WR 450 F	03-06	P60066
WR 450 F	07-11	P60014
WR 450 F	12-15	P60098
YZ 450 F	06-09	P60018
YZ 450 F	10-13	P6061A
YZ 450 F	2014	P60124

Asientos completos y sus fundas

Los asientos completos tienen las sujeciones incluidas, la funda de asiento es antideslizante e impermeable. Disponemos de asientos estándar y asientos con 2,5 cm más altos para una mayor comodidad. También disponemos de asientos Racing para supermotard.

HONDA	Año	Descripción	Asiento Normal	Asiento 2,5cm más alto	Asiento Racing
CR 125	00-07	asiento completo funda recambio	DMX04464 DMX04464B	DMX044642 DMX044642B	
CRF 250 R	04-09	asiento completo funda recambio	DMX04465 DMX04465B	DMX044652 DMX044652B	
CRF 250 R	10-13	asiento completo funda recambio	DMX04474 DMX04474B	DMX044742 DMX044742B	
CRF 250 R	14-15	asiento completo funda recambio	DMX04477 DMX04477B	DMX044772 DMX044772B	
CRF 450 R	05-08	asiento completo funda recambio	DMX04451 DMX04451B	DMX044512 DMX044512B	DMX044511 DMX044511B
CRF 450 R	09-12	asiento completo funda recambio	DMX04474 DMX04474B	DMX044742 DMX044742B	
CRF 450 R	14-15	asiento completo funda recambio	DMX04477 DMX04477B	DMX044772 DMX044772B	

KAWASAKI	Año	Descripción	Asiento Normal	Asiento 2,5cm más alto	Asiento Racing
KX 125	03-07	asiento completo funda recambio	DMX04462 DMX04462B	DMX044622 DMX044622B	
KX 250 F	04-05	asiento completo funda recambio	DMX04460 DMX04460B	DMX044602 DMX044602B	
KX 250 F	06-08	asiento completo funda recambio	DMX04452 DMX04452B	DMX044522 DMX044522B	
KX 250 F	09-12	asiento completo funda recambio	DMX04463 DMX04463B	DMX044632 DMX044632B	
KX 450 F	09-11	asiento completo funda recambio	DMX04463 DMX04463B	DMX044632 DMX044632B	

KTM	Año	Descripción	Asiento Normal	Asiento 2,5cm más alto	Asiento Racing
125 SX	11-13				
150 SX	11-13				
200 XC-W	12-13				
250 SX	11-13				
250 SX-F	11-13				
250 XC	11-13				
250 XC-F	11-13				
250 XC-W	12-13				
250 XCF-W	12-13				
300 XC	11-13	asiento completo	DMX04466	DMX044662	
300 XC-W	12-13	funda recambio	DMX04466B	DMX044662B	
350 EXC-F	12-13				
350 SX-F	11-13				
350 XC-F	11-13				
350 XCF-W	12-13				
450 SX-F	11-13				
450 XC-W	12-13				
500 EXC	12-13				
500 XC-W	12-13				

SUZUKI	Año	Descripción	Asiento Normal	Asiento 2,5cm más alto	Asiento Racing
RM 125 RM 250	01-07	asiento completo funda recambio	DMX04459 DMX04459B	DMX044592 DMX044592B	
RMZ 250	04-06	asiento completo funda recambio	DMX04460 DMX04460B	DMX044602 DMX044602B	
RMZ 450	05-07	asiento completo funda recambio	DMX04450 DMX04450B	DMX044502 DMX044502B	
RMZ 450	08-14	asiento completo funda recambio	DMX04471 DMX04471B	DMX044712 DMX044712B	

YAMAHA	Año	Descripción	Asiento Normal	Asiento 2,5cm más alto	Asiento Racing
YZ 125 YZ 250	02-14	asiento completo funda recambio	DMX04454 DMX04454B	DMX044542 DMX044542B	
YZ 250 F	03-05	asiento completo funda recambio	DMX04455 DMX04455B	DMX044552 DMX044552B	
YZ 250 F	06-09	asiento completo funda recambio	DMX04456 DMX04456B	DMX044562 DMX044562B	
YZ 250 F	10-13	asiento completo funda recambio	DMX04473 DMX04473B	DMX044732 DMX044732B	
YZ 250 F	14-15	asiento completo funda recambio	DMX04478 DMX04478B	DMX044782 DMX044782B	
WR 250 F	2015	asiento completo funda recambio	DMX04478 DMX04478B	DMX044782 DMX044782B	
YZ 450 F	06-09	asiento completo funda recambio	DMX04456 DMX04456B	DMX044562 DMX044562B	
YZ 450 F	10-13	asiento completo funda recambio	DMX04472 DMX04472B	DMX044722 DMX044722B	
YZ 450 F	14-15	asiento completo funda recambio	DMX04478 DMX04478B	DMX044782 DMX044782B	



Asiento



Funda



RUEDAS Y NEUMÁTICOS



ITP Holeshoot MXR 4* / MXR 6**

Medida	Referencia	PR	Límite de carga (kg.)	Peso (kg.)	P.V.P.
DELANTERO					
19x6-10**	532022	2	109	4,00	72,89
TRASERO					
18x10-8**	532023	2	132	5,60	74,54
19x10-9*	532064	2	132	5,70	74,54



holeshoot

Elección ideal para superficies poco compactas. Taco ampliamente separado para mejor agarre y auto-limpieza. Mantiene un perfil plano. La carcasa está reforzada para minimizar la elasticidad.

ITP Quad Cross MX PRO

Medida	Referencia	PR	Límite de carga (kg.)	Peso (kg.)	P.V.P.
DELANTERO					
20x6-10	560504	2	109	4,50	74,73
TRASERO					
18x10-8	560489	2	132	5,45	79,48



QUAD MX

El canto se ha desarrollado cuidadosamente para una previsibilidad y agarre lateral enormemente mejorados. El compuesto de goma blanda establece un nuevo estándar en pistas compactas. La combinación del Quad Cross MX Pro delantero y trasero reducirá segundos en el tiempo de vuelta de los corredores.

ITP Holeshoot SX

Medida	Referencia	PR	Límite de carga (kg.)	Peso (kg.)	P.V.P.
DELANTERO					
20x6-10	532019	2	109	4,20	76,43
TRASERO					
18x10-8	532018	2	132	5,50	78,43



holeshoot

Neumático con un nuevo compuesto de goma y diseño revolucionario para igualar la tracción del MXR4, pero aumentando su durabilidad entre 2 y 3 veces más. Recomendado para terreno seco y duro, y para largos recorridos tipo resistencia.

ITP Holeshoot SR

Medida	Referencia	PR	Índice	Peso (kg.)	P.V.P.
DELANTERO					
21x7R-10	598106	4	30F	5,35	79,44
TRASERO					
20x10R-9	598107	4	39F	6,45	86,94



holeshoot

La tecnología radial deportiva ofrece una conducción increíblemente sorprendente y un control excepcional. Neumático extremadamente ligero y sin embargo altamente duradero. El diseño de taco partido ofrece un rendimiento incomparable.

ITP Holeshoot XCR

Descripción	Referencia	PR	Límite de carga (kg.)	Peso (kg.)	P.V.P.
DELANTERO					
22x7-10	532008	6	125	6	82,45
TRASERO					
20x11-8	532053	6	160	6,85	79,84
20x11-9	598010	6	160	6,75	92,16



holeshoot

Carreras de Bosque y pista (XCR). Conducción de pista intermedia a dura, con surcos, pedregosa. El neumático Holeshoot de pista existente más rápido. De perfil más bajo, más estrecho y más ligero para una aceleración más rápida. El diseño de taco en ángulo proporciona un incremento de agarre lateral para tomar más rápido las curvas.

ITP Holeshoot XCT

Medida	Referencia	PR	Índice	Peso (kg.)	P.V.P.
TRASERO					
22x11-9	532038	6	180	9,00	88,85



holeshoot



Clasificado:
1° J.M. Gonzalez
"Pedregà"

Perfecto para terreno pedregoso y desierto. Protección extra en llanta y diseño que evita las pérdidas de aire. Extremadamente resistente a los pinchazos gracias a su compuesto especial.

● Homologado ITV
Los neumáticos que no tengan el punto ● no pueden utilizarse para asfalto

ITP Quad Cross XC

Medida	Referencia	PR	Índice	Peso (kg.)	P.V.P.
DELANTERO					
22x7-10	560546	6	125	6,00	78,27
TRASERO					
20x11-9	560547	6	160	7,35	90,61



Carreras de bosque, conducción de pista poco compacta a intermedia, con surcos, pedregosa. Diseñado específicamente para conducción de trail de alto rendimiento y carreras. El QuadCross XC utiliza todo el diseño que caracteriza al MX PRO, pero añade medidas más grandes requeridas para el uso de cross country. Incorpora una fuerte carcasa de 6 lonas para una resistencia más alta a los pinchazos. Este diseño beneficia la aceleración, el frenado, las curvas y también el equilibrio en general, reduciendo significativamente la fatiga y el tiempo de vuelta.

ITP Holeshoot GNCC

Medida	Referencia	PR	Índice	Peso (kg.)	P.V.P.
DELANTERO					
21x7-10	532029	6	125	6,30	101,47
22x7-10	598011	6	125	6,60	106,56
TRASERO					
20x10-9	598012	6	160	7,00	122,34
21x11-9	532027	6	160	8,00	122,34



Carreras de bosque, conducción de pista poco compacta a intermedia, con surcos, pedregosa. El neumático de una conducción superior y carreras de pista! Aligera la dirección y se mantiene recto, conducción suave. Agarre excepcional toma las curvas de forma equilibrada y tiene una excepcional auto-limpieza. Larga duración y altamente resistente a los pinchazos.

CARLISLE Turf Tamer

Medidas	Referencia	PR	Índice	Peso (kg.)	P.V.P.
21x12-8	45U3B7	3	279	7,2	52,04
20x11-9	45U3A7	3	284	6,8	55,80
25x12-9	55U373	3	284	8	139,05



Las características del neumático Turf Tamer, con fuertes laterales y unos vacíos centrales en los tacos, lo convierten en muy útil para una gran variedad de terrenos. Cuenta con el mejor agarre en terreno semi-blando y duro que cualquier otro neumático para quad.

XPEED X-100

Medida	Referencia	PR	Índice	Peso (kg.)	P.V.P.
TRASERO					
22x10-9	X100238	6	45J	8,60	67,83



CARLISLE Trail Wolf

Medida	Referencia	PR	Índice	Peso (kg.)	P.V.P.
DELANTERO					
19x8-8	537038	4	80	4,00	47,96
20x7-8	537039	2		5,00	55,00



Seleccionados para Bombardier y Yamaha para primeros equipos. El compuesto de goma más duro implica un menor desgaste y mayor durabilidad. El neumático estrella del mercado para recambio y primeros equipos.

● Homologado ITV

Los neumáticos que no tengan el punto ● no pueden utilizarse para asfalto

INNOVA Speed Gear

Medida	Referencia	PR	Índice	Peso (kg.)	P.V.P.
● 21x7-10	A8003A1	4	42N	4,55	51,00
● 22x7-10	A800309	4	45N	4,80	54,49
● 23x7-10	A800307	4	31J	5,40	65,15



Clasificados:
2º C. Avendaño
3º J.M. Peña



Clasificado:
3º J.M. Gonzalez
"Pedregà"

Neumático delantero con taco agresivo tipo Holeshot que le proporcionará un gran agarre y estabilidad tanto en competiciones como en el disfrute de su quad deportivo.

INNOVA Power Gear

Medida	Referencia	PR	Índice	Peso (kg.)	P.V.P.
● 18x10-8	A800208	4	38N	5,85	53,14
● 20x10-8	A8002E1	4		5,85	54,73
● 20x11-8	A8002E2	4	38J	6,10	62,65
● 22x11-8	A800287	4	42J	7,35	69,96
● 20x10-9	A8002A6	4	50N	5,65	59,88
● 20x11-9	A8002A7	4	56N	6,25	63,67
● 22x11-9	A800239	4	62N	7,20	67,56
● 20x11-10	A8002F2	4	37J	6,90	64,19
● 22x10-10	A8002A4	4	55N	6,60	62,62
● 22x11-10	A8002A5	4	60N	8,10	68,04



Neumático trasero con dibujo tipo Holeshot, especialmente diseñado para el total disfrute de su quad deportivo. Disfrute de la velocidad con la plena seguridad de llevar un neumático que le proporcionará un excelente agarre y manejo de su quad, y con la mejor relación calidad-precio del mercado.

● Homologado ITV

INNOVA Power Gear Enduro

Medida	Referencia	PR	Índice	Peso (kg.)	P.V.P.
● 20x11-9	A8X02A7	4	38J	7,30	70,35
● 22x11-9	A8X0239	4	42J	7,4	77,80



Clasificados:
2º C. Avendaño
3º J.M. Peña



Clasificado:
3º J.M. Gonzalez
"Pedregà"

Neumático de la misma tipología que el modelo Innova Power Gear pero con el taco más ancho y un 50% más alto, aumentando considerablemente las prestaciones del modelo normal.

INNOVA Land Hawk

Medida	Referencia	PR	Índice	Peso (kg.)	P.V.P.
DELANTERO					
18x7-7	A800777	2	6F	3,95	49,92
● 19x7-8	A800726	2	23F	4,35	53,92
TRASERO					
● 16x8-7	A800787	2	28J		37,65



Neumático especialmente diseñado para quads de pequeña y mediana cilindrada. Ideal para disfrutar de paseos suaves por el campo.

INNOVA Knobby Gear

Medida	Referencia	PR	Índice	Peso (kg.)	P.V.P.
● 145/70-6	A800919	2	1B	2,30	25,88
● 16x8-7	A800915	2	28J	2,80	34,71



Neumáticos mixtos pensados especialmente para quads infantiles.

XPEED X-500

Medida	Referencia	PR	Índice	Peso (kg.)	P.V.P.
20x7x8	X500279	2			51,69
22x10x8	X500286	2			58,66



Neumáticos pensados especialmente para quads de pequeña y mediana cilindrada.

● Homologado ITV

Los neumáticos que no tengan el punto ● no pueden utilizarse para asfalto

INNOVA Racer

Medida	Referencia	Índice	Peso (kg.)	P.V.P.
DELANTERO				
● 180/80-8 (19x7-8)	A802278	20N	4,30	45,39
● 165/70-10 (18.5x6.5-10)	A802286	27N	4,75	54,35
● 180/60-10 (19x7-10)	A802297	27N	4,15	49,44
● 175/70-10 (21x7-10)	A8022A1	42N	4,80	64,08
● 185/80-10 (22x7-10)	A8022A2	45N	5,20	62,54
● 185/88-12 (25x8-12)	A802206	40N	6,90	72,63
TRASERO				
● 240/55-8 (18x9.5-8)	A802246	24N	4,80	59,88
● 255/65-8 (21x10-8)	A802213	50N	6,45	69,95
● 215/50-9 (20x10-9)	A8022A7	50N	6,70	69,96
● 255/65-9 (22x10-9)	A802239	56N	7,90	75,70
● 225/45-10 (18x9-10)	A802291	32N	4,40	48,68
● 225/40-10 (18x10-10)	A802279	32N	5,45	59,06
● 255/60-10 (22x10-10)	A802255	55N	6,00	80,64
● 270/60-12 (25x10-12)	A802221	50N	9,25	89,18

● Homologado ITV



Ahora ya puede disfrutar en asfalto de su Quad / ATV. Le presentamos el neumático especialmente diseñado para asfalto, que le proporcionará total libertad de movimientos tanto en carretera como en ciudad. Para su comodidad, imprescindible equilibrar las llantas y reparar circunferencia de la llanta y estado de los rodamientos.

ITP Blackwater Evolution

Medida	Referencia	PR	Límite de carga (kg.)	Peso (kg.)	P.V.P.
DELANTERO					
26x9R-12	6P0041	8		11,6	158,11
27x9R-12	6P0064	8		11,9	173,07
27x9R-14	6P0062	8		12,5	180,04
28x9R-14	6P0113	8		13,4	188,82
TRASERO					
26x11R-12	6P0040	8		13,5	167,22
27x11R-12	6P0063	8		13,6	189,98
27x11R-14	6P0061	8		14,3	197,58
28x10R-14	6P0102	8		14,4	197,58
28x11R-14	6P0115	8		14,9	205,81
30x10R-14	6P0116	8		15,0	217,32



ITP Mud Lite XTR

Medida	Referencia	PR	Límite de carga (kg.)	Peso (kg.)	P.V.P.
DELANTERO					
25x8R-12	560398	6	153	10,4	94,62
26x9R-12	560387	6	184	12,5	114,46
TRASERO					
25x10R-12	560399	6	75F	12,7	120,86



Conducción de pista, y barrizales, pista poco compacta a intermedia, barro y nieve.

Composición de la banda de rodadura de larga duración. Taco de 28mm. Dos diámetros te proporcionan la capacidad de adaptar una elección de neumático a tus requerimientos específicos de conducción. La opción de 12 pulgadas es fundamentalmente ideal para condiciones en barro, ofreciendo mejor flexibilidad y más flotación.

ITP Holeshot ATR

Medida	Referencia	PR	Límite de carga (kg.)	Peso (kg.)	P.V.P.
DELANTERO					
205/80R-12 (25x8R12)	598104	6		8,5	90,25
205/85R-12 (26x8R12)	532072	6		9,0	98,96
TRASERO					
● 270/60R-12 (25x10R12)	598105	6	53F	9,4	101,85
255/70R-12 (26x10R12)	532073	6		10,0	105,54



Conducción de pista de uso general, con terrenos poco compactos a duros. Tecnología de neumático radial que ofrece una calidad de conducción suave y sorprendente los laterales flexibles amortiguan los choques de la pista.

La carcasa súper fuerte sigue y se mantiene recta y la construcción rediseñada del lateral ofrece un control sin igual tomando curvas.

ITP Mud Lite AT y XL

Medida	Referencia	PR	Límite de carga (kg.)	Peso (kg.)	P.V.P.
DELANTERO					
AT 23x8-11	56A304	6			72,45
AT 24x8-11	56A332	6			75,64
AT 24x9-11	56A3A9	6	164	8,0	81,64
AT 24x8-12	560430	6	139	7,3	79,53
● AT 25x8-12	560542	6	43F	7,2	73,22
XL 25x8-12	560363	6	206	8,9	89,86
● XL 26x9-12	5EA3P6	6	49F	10,9	107,62
XL 27x9-12	56A380	6	198	11,0	118,03
TRASERO					
AT 22x11-10	56A3A5	6	173	8,0	87,14
AT 24x11-10	56A305	6	198	9,0	87,24
AT 25x11-10	56A308	6	206	8,8	94,69
AT 24x10-11	56A328	6			88,94
AT 25x10-11	56A322	6			96,36
● AT 25x10-12	560522	6	50F	8,9	86,99
XL 25x10-12	560364	6	206	10,6	107,48
● XL 26x10-12	5EA343	6	52F	11,0	106,00
XL 27x10-12	56A345	6	206	13,3	125,53
XL 27x12-12	56A347	6	206	13,9	131,39
XL 28x10-12	56A349	6	223	12	139,03
XL 28x12-12	56A350	6	254	15	148,52



Conducción de pista y barrizales / Nieve.

Composición de goma para una duración más larga y de mejor calidad! Taco XL de 26mm. Neumático revolucionario en todas las condiciones: Es un neumático para barro de 6 lonas que está diseñado para todas las pistas. El área de contacto de centro único, proporciona una conducción suave parecida al radial.

INNOVA Mud Gear

Medidas	Referencia	PR	Índice	Peso (kg.)	P.V.P.
DELANTERO					
● AT 24x8-12	A800460	4	35L	8,7	81,83
● AT 25x8-12	A800406	4	35L	8,0	75,18
XL 26x8-12	A800375	6	46L	11,2	101,47
● XL 26x9-12	A800376	4	48N	12,2	120,96
● XL 27x9-12	A800380	4	51N	13,0	129,50
● XL 26x9-14	A800411	6	49L	13,6	133,78
TRASERO					
● AT 25x10-12	A800421	4	45L	9,0	85,04
● AT 25x11-12	A800422	6	53L	12,2	112,46
● XL 26x10-12	A800343	6	53L	12,9	121,76
● XL 26x12-12	A800361	4	56L	17,0	135,11
● XL 27x12-12	A800347	4	66L	17,8	161,28



Neumático de diseño cuadrado especialmente diseñado para barro. La dureza que le proporcionan sus 4 lonas le hace también apropiado para disfrutar en otros terrenos duros.

INNOVA Xtrem Lite

Medidas	Referencia	PR	Índice	Peso (kg.)	P.V.P.
DELANTERO					
● 25x8-12	A804406	6	43N	8,6	93,99
● 26x8-14	A804420	6	44N	12,2	96,52
TRASERO					
● 25x10-12	A804421	6	50N	10,2	111,35
● 26x10-14	A804436	6	51N	12,9	116,81



● Homologado ITV

Los neumáticos que no tengan el punto ● no pueden utilizarse para asfalto

ITP Terracross R/T 12" y 14"



Conducción de pista, de uso general poco compacta a dura, pedregosa, con nieve.

La composición de goma extra-fuerte aumenta considerablemente la duración de la banda de rodadura.

El TerraCross R/T XD del 2008 ofrece una durabilidad excepcional y fiabilidad, dando como resultado un neumático de más alto kilometraje. El modelo de la banda de rodadura entrelazado y amplio, da como resultado una excepcional tracción y flotación.

Ideal para barro, nieve y arena.

Los tacos cruzados del canto ofrecen una excelente protección del lateral y tracción cuando se conducen por pistas con surcos.

Medidas	Referencia	PR	Límite de carga (kg.)	Peso (kg.)	P.V.P.
DELANTERO					
25x8R-12	5E0423	6	153	11,0	131,92
26x9R-12	560475	6	74F	12,5	145,32
26x8R-14	560420	6	180	13,5	144,97
26x9R-14	560411	6	73F	14,9	149,15
TRASERO					
25x10R-12	5E0424	6	189	13,5	143,67
26x11R-12	560476	6	80F	14,9	164,75
26x11R-14	560412	6	79F	14,4	164,75

ITP Baja Cross

Medidas	Referencia	PR	Índice	Peso (kg.)	P.V.P.
DELANTERO					
● 25x8R-12	560505	8	73D	11,0	147,53
● 26x9R-12	560563	8	79D	12,5	158,50
● 26x10R14	560536	8	81D	13,5	166,88
TRASERO					
● 25x10R-12	560506	8	80D	13,5	159,02
● 26x11R-12	560564	8	85D	15,0	167,63
● 26x11R-14	560523	8	84D	15,0	176,47
28x10R-14	560584	8		14,4	187,12



BAJA CROSS

BAJA CROSS SPORT

Conducción de pista, de uso general, terreno intermedia a duro, con surcos, pedregosa. Preparado para la utilización de UTV más difíciles y duras. Su construcción de 8 lonas es un 25% más fuerte y duradero hasta ahora! La composición de la goma de larga duración y el innovador taco de superposición de la banda de rodadura proporciona una conducción suave y previsible, tan bien como de retraso de desgaste. - este es el neumático de más alto kilometraje que ITP ha producido! Los tacos escalonados proporcionan una banda de rodadura constante a medida que el neumático se desgasta, para un rendimiento previsible a través de la larga duración del neumático. Los tacos cruzados proporcionan una mejorada protección del canto. La protección súper profunda del talón, ofrece la mejor protección del borde de la llanta que existe en el mercado.

ITP Baja Cross Sport

Medidas	Referencia	PR	Índice	Peso (kg.)	P.V.P.
DELANTERO					
27x9R-14	6P0209	6		11,4	150,14
29x9R-14	6P0199	6		13,0	161,39
TRASERO					
27x11R-14	6P0210	6		13,3	165,94
29x11R-14	6P0200	6		15,5	170,77
30x10R-14	6P0087	8		15,6	217,87



Terreno liso, de uso general con superficies duras, velocidad más alta. Medida de 15 pulgadas!

El diseño de perfil bajo proporciona una conducción superior en superficies lisas y duras - tan bien como una llamativa apariencia! La superposición de los tacos de banda de rodadura ajustadamente espaciado, disminuye la resistencia a la rodadura y mejora el confort de conducción. El taco de la banda de rodadura se ha diseñado por ordenador para reducir los niveles de ruido. La construcción radial de 6 lonas y un nuevo componente de goma más duradero proporciona más duración y mejora la resistencia a cortes. Sorprendentemente ligero!

La protección súper profunda del talón, ofrece la mejor protección del borde de la llanta que existe en el mercado.

● Homologado ITV

Los neumáticos que no tengan el punto ● no pueden utilizarse para asfalto

ITP Ultra Cross

Medidas	Referencia	PR	Índice	Peso (kg.)	P.V.P.
27x10R-12	6P0251	8		14,3	174,87
27x10R-14	6P0252	8		14,8	176,16
27x10R-15	560550	6	75F	14,2	185,70
28x10R-14	6P0254	8		15,0	184,97
29x9R-14	6P0317	8		15,2	169,47
29x11R-14	6P0318	8		16,5	179,46
30x10R-14	6P0083	8		16,0	217,87

ITP Tundra Cross

Medidas	Referencia	PR	Límite de carga (kg.)	Peso (kg.)	P.V.P.
DELANTERO					
25x9-12	560544	6	186	8,9	76,42
TRASERO					
25x10-12	560545	6	206	9,2	78,04



TUNDRA
Cross

Neumático especial para nieve y hielo. El neumático lleva incorporados los clavos.

CARLISLE All Trail*/All Trail**

Medidas	Referencia	PR	Límite de carga (kg.)	Peso (kg.)	P.V.P.
DELANTERO					
22x9.50-10**	55A3N1	4	320	7,2	115,14
23x8-12*	511506	4	280	8,8	109,72
25x8-12*	511507	4	335	9,2	112,34
TRASERO					
20x10.00-8**	510043	4	297	6,8	65,92
22x10.00-8**	510044	4	337	7,2	77,90
20x10.00-10**	510045	4	290	6,6	72,45
24x10.50-10**	55A3N9	4	372	8,2	155,01
22x11.00-10*	510016	4	368	8,9	72,49
23x10.50-12*	511505	4	345	10,8	113,37
25x10.50-12*	511508	4	410	11,3	115,05



* **

Neumático excepcional para condiciones de terreno duro. Su polivalencia lo hace idóneo para usar en todo tipo de condiciones. Buena rodadura y resistencia a los pinchazos. Ideal para uso recreativo.

CARLISLE 489

Medidas	Referencia	PR	Límite de carga (kg.)	Peso (kg.)	P.V.P.
DELANTERO					
23x8-10	489326	3	136	6,4	68,81
24x8-11	489332	3	145	8,0	74,59
24x9-12	489342	3	120	8,0	78,41
● 25x8-12	560433	3	43F	6,9	82,48
TRASERO					
25x10-12	589339	3		9,0	92,31
● 25x11-12	560434	3	53F	9,0	92,31



Es el neumático elegido por los entusiastas que disfrutan de un suave paseo en quad. Combina alta tracción, buena absorción de irregularidades en el terreno, y excelente estabilidad, sin el desgaste habitual del neumático asociado a estas características.

ITP Llanta de aluminio SS112

Dimensiones	Desplazamiento	Ataque	SS112 Mecanizada	P.V.P.	SS112 Cromadas	P.V.P.	Caja 16 tornillos	P.V.P.
Artic Cat DVX 400 04-08 // Honda 250EX 00-13 / 300EX 93-12 / 400EX 99-13 / 450R 04-13 // Kawasaki KFX 400 03-05 / KFX 450 08-14 // Suzuki LTZ 250 02-12 / LTZ 400 03-12 / LTR 450 06-09 // Gas Gas 50 / 300 / 450 // Can-Am DS 450 07-13 (ALUG17BX)								
10x5 Del.	3 + 2	4/144	10SS10	83,59	10SC10	102,37	ALUG14BX	29,74
9x8 Tras.	3 + 5	4/110	98SS14	88,05			ALUG14BX	29,74
10x8 Tras.	3 + 5	4/110	10SS11	94,72	10SC11	106,72	ALUG14BX	29,74
Yamaha 250 Raptor 08-13 / 350 Banshee 91-07 / 350 Warrior 87-04 / 350R 04-14 / 660R 01-05 / YFZ 450 04-14 / YFZ 450 R 09-15 / Raptor 700 06-15								
10x5 Del.	3 + 2	4/156	10SS12	83,59	10SC12		ALUG15BX	29,74
9x8 Tras.	3 + 5	4/115	98SS15	88,05			ALUG15BX	29,74
10x8 Tras.	3 + 5	4/115	10SS13	94,72	10SC13	94,72	ALUG15BX	29,74



SS112 (Mecanizadas)

SS112 (Cromadas)

● Homologado ITV
Los neumáticos que no tengan el punto ● no pueden utilizarse para asfalto

XPEED Llanta de aluminio

Dimensiones	Posición	Modelo	Referencia	Desplazamiento	Ataque
Artic Cat DVX 400 04-08 // Honda 250EX 00-13 / 300EX 93-12 / 400EX 99-13 / 450R 04-13 // Kawasaki KFX 400 03-05 / KFX 450 08-13 // Suzuki LTZ 250 02-12 / LTZ 400 03-12 / LTR 450 06-09 // Gas Gas 50 / 300 / 450 // Can-Am DS 450 07-13 (ALUG17BX)					
10x5.5	Delantera	X-WIND	W10044	3.5+2	4/144
10x8	Trasera	X-WIND	W10110	3.5+4.5	4/110
10x5.5	Delantera	X-FLY	W11044	3.5+2	4/144
9x8	Trasera	X-FLY	W11910	3+5	4/110
10x8	Trasera	X-FLY	W11110	3.5+4.5	4/110
Yamaha 250 Raptor 08-13 / 350 Banshee 91-07 / 350 Warrior 87-04 / 350R 04-14 / 660R 01-05 / YFZ 450 04-14 / YFZ 450 R 09-15 / Raptor 700 06-15					
10x5.5	Delantera	X-WIND	W10056	3.5+2	4/156
10x8	Trasera	X-WIND	W10115	3.5+4.5	4/115
10x5.5	Delantera	X-FLY	W11056	3.5+2	4/156
9x8	Trasera	X-FLY	W11915	3+5	4/115
Aeon 180 / Sporty 200					
10x5.5	Delantera	X-WIND	W10010	3.5+2	4/110
10x5.6	Delantera	X-FLY	W11010	3.5+3	4/156
10x8	Trasera	X-FLY	W11111	3.5+4.5	4/110

P.V.P
59,80

NOTA:
Estas llantas deben usar tornillos cónicos.
DAT06079BX - 16 unidades - P.V.P. 29,74€
DAT06079 - 4 unidades - P.V.P. 8,00€



X-Wind



X-Fly

ITP Llanta de aluminio Baja / Track-Lock



X-Baja



Baja



	Dimensiones	Posición	Referencia	Desplazamiento	Ataque	P.V.P.	Caja 16 tornillos	P.V.P.
Cannondale 440 01-03 // Honda 250R 86-89 / 250EX 00-14 / 300EX 93-13 / 400EX '99-14 / 450R 04-14 // Kawasaki KFX 400 03-06 // Suzuki LTZ400 03-14 / LTR 450 06-09 // Gas Gas 50 / 300 / 450								
X-Baja	10x5	Delantera	R105144	3+2	4/144	99,23	DAT06079BX	29,74
	9x8	Trasera	R098110	3+5	4/110	86,95	DAT06079BX	29,74
	10x5	Delantera	BR1542	3+2	4/144	140,21	ALUG15BX	29,74
Baja	8x8.5	Trasera	BR8941	3+5.5	4/110	111,47	ALUG15BX	29,74
	9x9	Trasera	BR9141	3+6	4/110	121,62	ALUG15BX	29,74
Kawasaki KFX 700 03-09								
Baja	10x5	Delantera	BR1542	3+2	4/144	140,21	ALUG15BX	29,74
	9x9	Trasera	BR9137	3+6	4/137	121,62	ALUG15BX	29,74
Yamaha 250 Raptor 08-14 / 350 Banshee 91-06 / 350 Warrior 87-04 / 350 Raptor 04-14 / YFZ 450 04-14 / YFZ 450R 09-15 / 660 Raptor 01-05 / Raptor 700 06-15								
X-Baja	10x5	Delantera	R105156	3+2	4/156	99,23	DAT06079BX	29,74
	9x8	Trasera	R098115	3+5	4/115	86,95	DAT06079BX	29,74
	10x5	Delantera	BR1552	3+2	4/156	140,81	ALUG15BX	29,74
Baja	8x8.5	Trasera	BR8942	3+5.5	4/115	111,47	ALUG15BX	29,74
	9x9	Trasera	BR9142	3+6	4/115	121,62	ALUG15BX	29,74
Track-Lock	8x8*	Trasera	TL8842	3+5	4/115	156,06	ALUG15BX	29,74



Referencia	Descripción	P.V.P.
W00412BX	4 Válvulas cromadas	7,60



Referencia	Descripción	P.V.P.
ALOCK110	4 tuercas antirobo M10x125	38,84



Referencia	Descripción	P.V.P.
DAT06079	4 tuercas M10x125	8,00

RUEDAS Y NEUMÁTICOS

XPEED X-5 / X-6

ITP T-5 / T-7 / T-7C



X-6
P.V.P. 72,90€



X-5
P.V.P. 72,90€



T-5
P.V.P. 83,90€



T-7 14"
P.V.P. 83,90€



T-7C Cromado
P.V.P. 83,90€

Dimensiones	Desplazamiento	Ataque	Xpeed Tipo X-6	Xpeed Tipo X-5	ITP Tipo 5	ITP Tipo 7	ITP Tipo 7C	Tapa bujes cromados	Tornillos Cromados
BOMBARDIER Traxter / Quest 650 // HONDA 300 4x4 / Rancher 350 S-ES / Rancher 400 -420 4x4 / Foreman 400 / Foreman 450-500 S-ES / Rubincon 500 // KYMCO MXU 500 // SUZUKI Eiger / King Quad 400 / Vinson // YAMAHA Grizzly 350 / Bruin 350 / Wolverine 350 / Big Bear 350 -400 / Kodiak 400-450 / Grizzly 600									
12x7 Del.	5+2	4/110		W22110	12D110			P110BX	W00011BX
12x7 Tras.	2+5	4/110			12D111*		12D511*	P110BX	W00011BX
12x7,5 Tras.	2,5+5	4/110		W22111*					W00011BX
14x7 Del.	5+2	4/110				14D110		P110BX	W00011BX
14x7 Tras.	2+5	4/110				14D111		P110BX	W00011BX
HONDA Rincon 650 - 680 // KAWASAKI Brute Force 650i / Brute Force 750 // SUZUKI King Quad 450 -700 - 750 // YAMAHA Kodiak 400 -450 / Grizzly 400 - 450 - 660 / Rhino 450 - 660 - 700 * Si se requiere una mayor anchura (entre 5 y 7 cm por llanta) superior en el eje trasero sobre el delantero, montar las llantas trasera del apartado superior marcadas con asterisco (*)									
12x7 Del.	5+2	4/110	W12110	W22110					W00011BX
12x7 Tras.	5+2	4/110	W12110	W22110					W00011BX

P.V.P.
29,74

ITP Complementos llanta

Precio para caja de 16 tuercas



ITP
W00020BX
M10x125



ITP
ALUG15BX
M10x125



ITP
ALUG16BX
M12x125



ITP
ALUG11BX
3/8" - 24



XPEED
DAT06079BX
M10x125



ITP
BLUG11BX
M10x125



XPEED
W00011BX
M10x125



ITP
ALUG14BX
M10x125



ITP
ALUG17BX
M10x150



ITP
ALUG18BX
M12x150



ITP
ALUG19BX
M12x125



ITP
ALUG13BX
3/8" - 24



4 unidades



1 unidad



1 unidad

Referencia	Descripción	P.V.P.
P110BX	Ataque 110 y 115	27,00

Referencia	Descripción	P.V.P.
P110SS	Ataque 110 y 115	8,20
P137SS	Ataque 137	8,20
P156SS	Ataque 156	8,20

Referencia	Descripción	P.V.P.
C110SS	Ataque 110 y 115	8,20
C137SS	Ataque 137	8,20
C156SS	Ataque 156	8,20



Llanta de aluminio 12" / 14"

SS106 / SS112 / SS212 / SS312



SS106

12x7" P.V.P. 69,99€
14x6" P.V.P. 69,99€
14x8" P.V.P. 69,99€
(Mecanizadas)



SS112

12x7" P.V.P. 95,91€
14x6" P.V.P. 107,60€
14x8" P.V.P. 116,92€
(Mecanizadas)



SS112C

12x7" P.V.P. 155,66€
14x6" P.V.P. 155,66€
14x8" P.V.P. 155,66€
(Cromadas)



SS212

12x7" P.V.P. 95,91€
14x6" P.V.P. 107,60€
14x8" P.V.P. 116,92€
(Mecanizadas)



SS212B

12x7" P.V.P. 95,91€
14x6" P.V.P. 107,60€
14x8" P.V.P. 116,92€
(Negra)



SS312

12x7" P.V.P. 95,91€
14x6" P.V.P. 107,60€
14x8" P.V.P. 116,92€
(Mecanizadas)



Hurricane

12x7" P.V.P. 95,91€
14x7" P.V.P. 110,21€
(Negra)

Dimensiones	Desplazamiento	Ataque	SS106 Mecanizada	SS112 Mecanizada	SS112C Cromada	SS212 Mecanizada	SS212B Negra	SS312 Mecanizada	Hurricane Negra	Tornillos Cromados
BOMBARDIER Traxter / Quest 650 // HONDA 300 4x4 / Rancher 350 S-ES / Rancher 400 -420 4x4 / Foreman 400 / Foreman 450-500 S-ES / Rubicon 500 // KYMCO MXU 500 // SUZUKI Eiger / King Quad 400 / Vinson // YAMAHA Grizzly 350 / Bruin 350 / Wolverine 350 / Big Bear 350 -400 / Kodiak 400-450 / Grizzly 600										
12x7 Del.	5+2	4/110		12SS30	12SS70			12SS700		ALUG14BX
12x7 Tras.	2+5	4/110	12SS11*	12SS31*	12SS71*			12SS701*		ALUG14BX
14x6 Del.	4+2	4/110		14SS30	14SS70	14SS300				ALUG14BX
14x8 Tras.	3+5	4/110	14SS11*	14SS31*	14SS71*	14SS301*				ALUG14BX
HONDA Rincon 650 - 680 // KAWASAKI Brute Force 650i / Brute Force 750 // SUZUKI King Quad 450 -700 - 750 // YAMAHA Kodiak 400 -450 / Grizzly 400 - 450 - 660 / Rhino 450 - 660 - 700 * Si se requiere una mayor anchura (entre 5 y 7 cm por llanta) superior en el eje trasero sobre el delantero, montar las llantas trasera del apartado superior marcadas con asterisco (*)										
12x7 Del.	5+2	4/110		12SS30		12SS300	12SS400	12SS700		ALUG14BX
12x7 Tras.	5+2	4/110		12SS30		12SS300	12SS400	12SS700		ALUG14BX
14x6 Del.	4+2	4/110		14SS30	14SS70	14SS300				ALUG14BX
14x7 Del./Tras.	5+2	4/110							14RB110	
14x8 Tras.	5+3	4/110	14SS12	14SS32	14SS72	14SS302				ALUG14BX
ARTIC CAT 300i / 400i / 500i / 650i / 700i / 1000 / Prowler / Wild Cat										
12x7 Del.	5+2	4/115				12SS309		12SS709		ALUG14BX
12x7 Tras.	5+2	4/115				12SS309		12SS709		ALUG14BX
14x6 Del.	4+2	4/115								ALUG14BX
14x7 Del./Tras.	5+2	4/115							14RB115	
14x8 Tras.	5+3	4/115								ALUG14BX
CAN-AM Outlander 330/400/500/650/800/1000 / Renegade 500/800/1000 / Commander 800/1000 / Maverick 800/1000										
12x7 Del.	4+3	4/137						12SS706		ALUG15BX
12x7 Tras.	4+3	4/137						12SS706		ALUG15BX
12x7 Del./Tras.	5+2	4/137							12RB118	
14x6 Del.	4+2	4/137						14SS706		ALUG15BX
14x7 Del./Tras.	5+2	4/137							14RB118	
14x8 Tras.	5+3	4/137						14SS711		ALUG15BX
KAWASAKI Praire 360 / 400 / 650 / 700 / Brute Force 650 / Mule 500/600/610 // SUZUKI Twin Peaks 700										
12x7 Del.	4+3	4/137								ALUG15BX
12x7 Tras.	2+5	4/137	12SS17							ALUG15BX
14x6 Del.	4+2	4/137								ALUG15BX
14x8 Tras.	3+5	4/137	14SS17							ALUG15BX
KAWASAKI Teryk 750										
12x7 Del.	5+2	4/137 12m/m				12SS308				ALUG16BX
12x7 Tras.	5+2	4/137 12m/m				12SS308				ALUG16BX
KAWASAKI Brute Force 750i										
12x7 Del.	5+2	4/110				12SS346				ALUG14BX
12x7 Tras.	5+2	4/110				12SS346				ALUG14BX
POLARIS Sportsman / Sportsman 400-450 / Sportsman 500 / Magnum 500 / Sportsman 600 / Sportsman 700 / Sportsman 800 / Ranger3 / RZR 800 / RZR 800 S / RZR 900 XP / RZR 1000 / Ranger 900 XP (Scrambler 850 / Sportsman 550 XP / Sportsman 850 XP Solo llanta 14")										
12x7 Del.	4+3	4/156				12SS303		12SS703		ALUG13BX
12x7 Tras.	4+3	4/156				12SS303		12SS703		ALUG13BX
14x6 Del.	4+2	4/156		14SS33				14SS703		ALUG13BX
14x7 Del./Tras.	4+3	4/156							14RB156	
14x8 Tras.	5+3	4/156		14SS35				14SS705		ALUG13BX
14x8 Tras.	3+5	4/156		14SS42						ALUG13BX

RUEDAS Y NEUMÁTICOS

ITP Llantas SS212 de 15"



Medidas	Referencia	Desplazamiento	Ataque	Aplicación	P.V.P.
15x7	15SS600	5+2	4/110	Kawa.Terix - Yam.Rhino - Ausa - Obey	164,60
15x7	15SS609	5+2	4/115	Artic Cat Prowler	164,60
15x7	15SS608	5+2	4/137 12 mm	Kawasaki Mule	164,60
15x7	15SS603	5+2	4/156	Polaris RZR / Ranger	164,60

Interpretación de las medidas

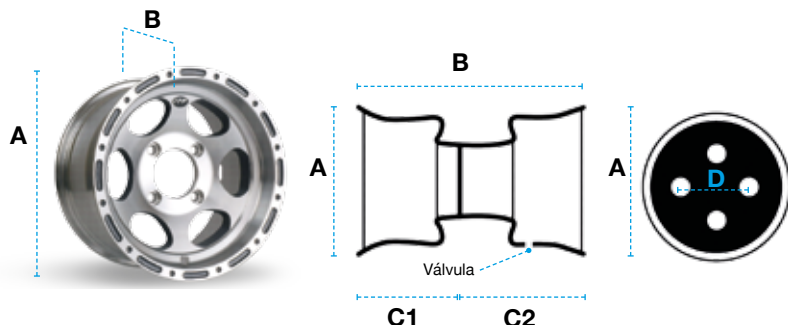

DIMENSIONES
A x B
(12x7)

DESPLAZAMIENTO
C1 + C2
(5+2)

ATAQUE
Nº de agujeros / D
(4 / 110)

Llanta

Dimensiones	Desplazamiento	Ataque	Referencia
12x7	5+2	4/110	12D210
Dimensión en pulgadas	En pulgadas	En pulgadas	Referencia del producto

Neumáticos

Descripción	Referencia	PR	Límite de carga (Kg)	Peso (Kg)
● 21x7-10	A8003A1	4	93	4,55
Dimensión en pulgadas	Referencia del producto	Índice de lonas	Máximo peso que soporta el neumático (recomendable)	Peso aprox. del neumático



DIMENSIONES (Descripción)
A x B - C
(21 x 7 - 10)

Descripción	Referencia	Índice	Peso (Kg)
● 175 / 70-10	A8022A1	42N	4,55
Dimensiones milimétricas	Referencia del producto	42 Índice de carga	Peso aprox. del neumático
Llanta en pulgadas		N Índice de velocidad	



DIMENSIONES (Descripción)
A x B - C
(175/70 R10)

● Indica neumático homologado

Índice de carga

Índice	Kg	Índice	Kg	Índice	Kg	Índice	Kg
20	80	35	121	50	190	65	290
21	82	36	125	51	195	66	300
22	85	37	128	52	200	67	307
23	87	38	132	53	206	68	315
24	90	39	136	54	212	69	325
25	92	40	140	55	218	70	335
26	95	41	145	56	224	71	345
27	97	42	150	57	230	72	355
28	100	43	155	58	236	73	365
29	103	44	160	59	243	74	375
30	106	45	165	60	250	75	387
31	109	46	170	61	257	76	400
32	112	47	175	62	265	77	412
33	115	48	180	63	272	78	425
34	118	49	185	64	280	79	437

Índice Velocidad

Índice	Km / h	Índice	Km / h
A1	5	K	110
A2	10	L	120
A3	15	M	130
A4	20	N	140
A5	25	P	150
A6	30	Q	160
A7	35	R	170
A8	40	S	180
B	50	T	190
C	60	U	200
D	65	H	210
E	70	V	240
F	80	W	270
G	90	Y	300
J	100		

Cantidades



< 75 Km/h

$\emptyset(\text{cm}) \times \text{An} (\text{cm}) \times 0,55 = \text{ml}$

> 75 Km/h

$\emptyset(\text{cm}) \times \text{An} (\text{cm}) \times 0,3 = \text{ml}$



Ejemplo:

Speed Gear Quad

21x7-10

53Ø x 18An x 0,3= 315 ml slime



Sellador

Referencia	Descripción	P.V.P
DUP12216	250 ml	4,65
DUP122162	473 ml	8,32



Probado en pinchazos a gran velocidad



Mini compresor de viaje

El kit Slime incluye:

- Un compresor con manómetro y conexiones.
- Mazo de cableado principal con fusible.
- Manguito aire.
- Pinzas de batería.
- Precableado directo a batería.

XPEED 3 Cargas CO2 16gr.



Referencia	P.V.P
X30501	8,00

Referencia	Peso (kg)	Dimensiones (cm)	P.V.P
S40006	0,95	15X16X6	42,12



BRONCO Kit repara pinchazos con bolsa

Referencia	P.V.P
DAT12208	23,76



4 Tapones aluminio



PLATA

AZUL

Referencia	P.V.P	Referencia	P.V.P
S1020	5,80	S1018	5,80



Kit repara pinchazos y recambios tiras

Referencia	Descripción	P.V.P
DUP12307A	Recambio 10 mechas	4,13
S21032	Kit repara pinchazos	7,20



S21032

DUP12307A



Kit profesional



Referencia	P.V.P
S2510	20,71

RUEDAS Y NEUMÁTICOS

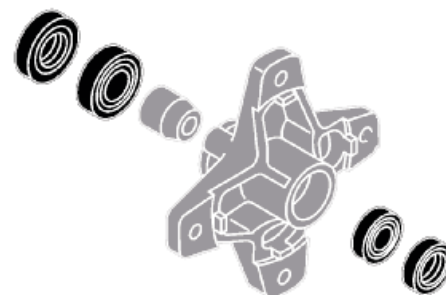

BRONCO Kit rodamientos ruedas o eje trasero

El kit consta de todas las piezas para reparar un buje a excepción del **DAT06612** que es para dos bujes. Los vehículos con eje rígido trasero, el kit incluye el material para todo el buje.

ARTIC CAT	KIT DELANTERO			KIT TRASERO	
	Año	Referencia	P.V.P.	Referencia	P.V.P.
400 DVX	04-08	DAT06636	21,90	DAT06620	23,18
todos	96-04	DAT06623	29,11	DAT06623	29,11
todos	05-14	DAT06624	28,52	DAT06624	28,52

CAN AM	KIT DELANTERO			KIT TRASERO	
	Año	Referencia	P.V.P.	Referencia	P.V.P.
400 Outlander	06-14	DAT06631	27,05	DAT06631	27,05
450 DS	08-14	DAT06631	27,05		
500 Traxter	99-01	DAT06628	27,93		
500 Outlander	07-14	DAT06631	27,05	DAT06631	27,05
500 Renegade	08-14	DAT06631	27,05	DAT06631	27,05
650 Outlander	07-14	DAT06631	27,05	DAT06631	27,05
800 Commander	11-15	DAT06631	27,05	DAT06631	27,05
800 Outlander	06-14	DAT06631	27,05	DAT06631	27,05
800 Renegade	07-14	DAT06631	27,05	DAT06631	27,05
1000 Commander	11-15	DAT06631	27,05	DAT06631	27,05
1000 Maverick	14-15	DAT06631	27,05	DAT06631	27,05
1000 Outlander	12-14	DAT06631	27,05	DAT06631	27,05
1000 Renegade	12-14	DAT06631	27,05	DAT06631	27,05

GAS GAS	KIT DELANTERO			KIT TRASERO	
	Año	Referencia	P.V.P.	Referencia	P.V.P.
Wild 300 HP	03-06	DAT06654	16,61		
Wild 450 HP	03-08	DAT06654	16,61		

HONDA	KIT DELANTERO			KIT TRASERO	
	Año	Referencia	P.V.P.	Referencia	P.V.P.
TRX 250 Sportrax	01-14	DAT06642	16,61	DAT06640	36,75
TRX 250 Recon	97-14	DAT06629	16,86	DAT06640	36,75
TRX 300 Sportrax	93-09	DAT06654	16,61	DAT06617	23,08
TRX 300 Fourtrax 2x4	88-00			DAT06611	19,22
TRX 300 Fourtrax 4x4	88-00	DAT06600	29,40	DAT06611	19,22
TRX 350 Rancher FM/FE	00-06	DAT06630	29,55	DAT06609	35,13
TRX 350 Rancher TE/TM	00-06	DAT06629	16,86	DAT06609	35,13
TRX 400 Sportrax	99-01	DAT06654	16,61	DAT06617	23,08
TRX 400 Sportrax	02-14	DAT06642	16,61	DAT06617	23,08
TRX 400 Foreman	95-03	DAT06602	29,40	DAT06609	35,13
TRX 400 Rancher	04-07	DAT06630	29,55	DAT06609	35,13
TRX 420 Rancher	07-14	DAT06600	29,40	DAT06656	28,22
TRX 450 R	04-14	DAT06642	16,61	DAT06647	27,64
TRX 450 Fourtrax	98-04	DAT06602	29,40	DAT06609	35,13
TRX 500 Rubicon	01-04	DAT06602	29,40	DAT06609	35,13
TRX 500 Rubicon	05-15	DAT06637	29,84	DAT06609	35,13
TRX 650 Rincon	03-05	DAT06602	29,40	DAT06660	26,31
TRX 680 Rincon	06-15	DAT06637	29,84	DAT06660	26,31
TRX 700 XX	08-09			DAT06656	28,22

KAWASAKI	KIT DELANTERO			KIT TRASERO	
	Año	Referencia	P.V.P.	Referencia	P.V.P.
KSF 250 Mojave	88-04			DAT06644	22,79
KEF 300 Lakota	95-03			DAT06644	22,79
KVF 300 Brute Force	12-14	DAT06654	16,61		
KVF 300 A Prairie	99-02	DAT06627	28,52		
KVF 300 B Prairie	99-02	DAT06627	28,52		
KLF 300 B Bayou	88-04			DAT06633	21,02
KLF 300 C Bayou	88-04	DAT06627	28,52		
KVF 360 Prairie	03-13	DAT06627	28,52		
KFX 400	03-06	DAT06636	21,90	DAT06620	23,18
KLF 400 Bayou	93-99	DAT06627	28,52		
KVF 400 Prairie	97-02	DAT06627	28,52		
KFX 450 R	08-14	DAT06654	16,61	DAT06652	27,93

KVF 650 Prairie	02-03	DAT06627	28,52		
KVF 650 Brute Force	05-13	DAT06627	28,52		
KVF 650 i Brute Force	06-09			DAT06633	21,02
KFX 700 V-Force	04-09	DAT06654	16,61		
KVF 700 Prairie	04-06	DAT06627	28,52		
KVF 750i Brute Force	05-15			DAT06633	21,02
TERYX 750	2008			DAT06633	21,02

KTM	KIT DELANTERO			KIT TRASERO	
	Año	Referencia	P.V.P.	Referencia	P.V.P.
450 SX	09-10			DAT06649	43,94
450 XC	08-09			DAT06649	43,94
505 SX	09-10			DAT06649	43,94
525 XC	08-09			DAT06649	43,94

KYMCO	KIT DELANTERO			KIT TRASERO	
	Año	Referencia	P.V.P.	Referencia	P.V.P.
KXR 250		DAT06654	16,61		
Maxxer 250		DAT06654	16,61		
MXU 250	04-05	DAT06654	16,61		
Maxxer 300		DAT06654	16,61		
MXU 300	05-08	DAT06654	16,61		
MXU 400		DAT06624	28,52	DAT06624	28,52
MXU 500		DAT06624	28,52	DAT06624	28,52

POLARIS	KIT DELANTERO			KIT TRASERO	
	Año	Referencia	P.V.P.	Referencia	P.V.P.
200 Phoenix	2005	DAT06626	16,70		
250 Trail Boss	88-99	DAT06643	27,78	DAT06618	21,37
250 Trail Blazer	90-98	DAT06643	27,78	DAT06618	21,37
250 Trail Blazer	99-04	DAT06643	27,78	DAT06613	27,20
250 Trail Blazer	05-06	DAT06626	16,70	DAT06613	27,20
250 Xplorer 4X4	00-02	DAT06604	26,15	DAT06613	27,20
300 Hawkeye	06-11	DAT06622	26,31	DAT06622	26,31
300 Sportsman 4X4	08-10	DAT06622	26,31	DAT06622	26,31
325 Magnum 2x4	00-01	DAT06643	27,78		
325 Magnum 2x4	2002	DAT06643	27,78	DAT06622	26,31
325 Magnum 4x4	00-01	DAT06604	26,15		
325 Magnum 4x4	2002	DAT06604	26,15	DAT06622	26,31
325 Magnum 4x4 HDS	01-02	DAT06622	26,31	DAT06622	26,31
325 Trail Boss	00-02	DAT06643	27,78	DAT06613	27,20
330 Magnum 2x4	03-05	DAT06643	27,78	DAT06622	26,31
330 Magnum 4x4	03-05	DAT06622	26,31	DAT06622	26,31
330 Trail Blazer	08-09	DAT06626	16,70	DAT06613	27,20
330 Trail Blazer	10-13	DAT06622	26,31	DAT06613	27,20
330 Trail Boss	03-04	DAT06643	27,78	DAT06613	27,20
330 Trail Boss	05-09	DAT06626	16,70	DAT06613	27,20
330 Trail Boss	10-13	DAT06622	26,31	DAT06613	27,20
335 Sportsman	99-00	DAT06604	26,15	DAT06612	55,13
400 Hawkeye	12-14	DAT06622	26,31	DAT06612	55,13
400 Scrambler 2x4	01-02	DAT06643	27,78	DAT06613	27,20
400 Scrambler 4x4	95-97	DAT06604	26,15	DAT06618	21,37
400 Scrambler 4x4	98-02	DAT06604	26,15	DAT06613	27,20
400 Sport	94-98	DAT06643	27,78	DAT06618	21,37
400 Sport	1999	DAT06643	27,78	DAT06613	27,20
400 Sportsman	94-97	DAT06604	26,15	DAT06618	21,37
400 Sportsman	01-04	DAT06604	26,15	DAT06612	55,13
400 Sportsman	05-06	DAT06622	26,31	DAT06612	55,13
400 Sportsman HO	08-10	DAT06622	26,31	DAT06622	26,31
400 Sportsman HO	11-14	DAT06622	26,31	DAT06612	55,13
400 Trail Blazer	2003	DAT06643	27,78	DAT06613	27,20
425 Xpedition	00-01	DAT06604	26,15		
425 Xpedition	2002	DAT06604	26,15	DAT06622	26,31



DAT06657



DAT06651

BRONCO Kit rodamientos ruedas o eje trasero

450 Outlaw	08-10	DAT06626	16,70	DAT06648	47,11
450 Sportsman	06-07	DAT06622	26,31	DAT06612	55,13
500 ATP 4X4	04-05	DAT06622	26,31	DAT06622	26,31
500 Magnum 4X4	99-01	DAT06604	26,15		
500 Magnum 4X4 HDS	01-03	DAT06622	26,31	DAT06622	26,31
500 Magnum 2X4 HDS	2002	DAT06643	27,78	DAT06622	26,31
500 Magnum 4X4	2002	DAT06622	26,31	DAT06622	26,31
500 Outlaw	06-07	DAT06626	16,70	DAT06622	26,31
500 Predator	2003	DAT06626	16,70	DAT06649	43,94
500 Predator	04-07	DAT06626	16,70	DAT06648	47,11
500 Ranger 2x4	08-09	DAT06622	26,31	DAT06612	55,13
500 Ranger 4x4	05-08	DAT06622	26,31	DAT06612	55,13
500 Ranger	09-10	DAT06657	32,05	DAT06612	55,13
500 Ranger	11-13	DAT06622	26,31	DAT06612	55,13
500 Scrambler 2x4	00-02	DAT06643	27,78	DAT06613	27,20
500 Scrambler 2x4	2008	DAT06626	16,70	DAT06613	27,20
500 Scrambler 4x4	1997	DAT06604	26,15	DAT06618	21,37
500 Scrambler 4x4	98-09	DAT06604	26,15	DAT06613	27,20
500 Scrambler 4x4	10-12	DAT06622	26,31	DAT06613	27,20
500 Sportsman 4x4	96-03	DAT06604	26,15	DAT06612	55,13
500 Sportsman 4x4	04-14	DAT06622	26,31	DAT06612	55,13
525 Outlaw IRS	07-11	DAT06626	16,70	DAT06622	26,31
525 Outlaw S	08-10	DAT06626	16,70	DAT06648	47,11
550 Sportsman	09-14	DAT06657	32,05	DAT06657	32,05
600 Sportsman	03-05	DAT06622	26,31	DAT06612	55,13
700 Sportsman	02-08	DAT06622	26,31	DAT06612	55,13
700 Ranger	05-08	DAT06622	26,31	DAT06612	55,13
700 Ranger	2009	DAT06657	32,05	DAT06612	55,13
800 Sportsman	05-12	DAT06622	26,31	DAT06612	55,13
800 Ranger	10-14	DAT06657	32,05	DAT06612	55,13
800 RZR	08-09	DAT06659	26,31	DAT06612	55,13
800 RZR	11-14	DAT06657	32,05	DAT06612	55,13
800 RZR "S"	2009	DAT06659	26,31	DAT06612	55,13
800 RZR "S"	10-14	DAT06657	32,05	DAT06612	55,13
800 RZR 4	2011	DAT06657	32,05	DAT06612	55,13
850 Sportsman	09-14	DAT06657	32,05	DAT06657	32,05
900 Ranger	11-14	DAT06657	32,05	DAT06612	55,13
900 RZR XP	11-14	DAT06657	32,05	DAT06657	32,05
900 RZR XP "4"	13-14	DAT06657	32,05	DAT06657	32,05

KIT DELANTERO KIT TRASERO

SUZUKI	Año	Referencia	P.V.P.	Referencia	P.V.P.
LT-F 250 Quadrunner	99-01	DAT06610	20,14	DAT06614	28,67
LT-Z 250 QuadSport	05-09	DAT06636	21,90		
LT-F 300 King Quad	91-98	DAT06610	20,14	DAT06614	28,67
LT-F 300 King Quad	99-02	DAT06610	20,14	DAT06614	28,67
LT-A 400 Eiger	02-07	DAT06610	20,14	DAT06672	16,76
LT-F 400 Eiger	02-07	DAT06610	20,14	DAT06672	16,76
LT-A 400 King Quad	08-14	DAT06610	20,14	DAT06672	16,76
LT-F 400 King Quad	08-14	DAT06610	20,14	DAT06672	16,76
LT-Z 400 QuadSport	03-08	DAT06636	21,90	DAT06620	23,18
LT-Z 400 QuadSport	2009	DAT06636	21,90	DAT06647	27,64
LT-R 450	06-11	DAT06636	21,90	DAT06651	33,52
LT-A 450 King Quad	07-10	DAT06666	31,75	DAT06667	34,69
LT-F 500 Quad Runner	98-01	DAT06610	20,14	DAT06672	16,76
LT-A 500 Quad Master	00-01	DAT06610	20,14	DAT06672	16,76
LT-A 500 Vinson	02-07	DAT06610	20,14	DAT06672	16,76
LT-F 500 Vinson	03-07	DAT06610	20,14	DAT06672	16,76
LT-A 500	09-14	DAT06666	31,75	DAT06667	34,69
LT-V 700 Twin Peaks	04-06	DAT06627	28,52		
LT-A 700 King Quad	05-07	DAT06666	31,75	DAT06667	34,69
LT-A 750i King Quad	08-14	DAT06666	31,75	DAT06667	34,69

YAMAHA	KIT DELANTERO		KIT TRASERO		
	Año	Referencia	P.V.P.	Referencia	P.V.P.
YFM 50 Raptor	04-08	DMX06200	22,26		
YFM 80 Badger	92-01	DMX06200	22,26		
YFM 80 Raptor	02-08	DMX06200	22,26		
YFA-1 Breeze	91-04	DMX06200	22,26		
YFM 125 Grizzly	04-13	DMX06200	22,26		
YFM 125 Raptor	11-13	DAT06635	23,52	DAT06650	22,34
YFS 200 Blaster	88-02	DAT06655	26,02	DAT06615	21,76
YFS 200 Blaster	03-06	DAT06635	23,52	DAT06615	21,76
YFM 250 Raptor	08-13	DAT06635	23,52	DAT06650	22,34
YFB 250 Timberwolf	95-98	DAT06635	23,52		
YFM 250 Beartracker	99-00			DAT06607	34,99
YFM 250 Beartracker	01-04	DAT06635	23,52	DAT06668	34,40
YFM 250 Bruin	05-06	DAT06635	23,52	DAT06668	34,40
YFM 250 Big Bear	07-09	DAT06635	23,52	DAT06668	34,40
YFM 300 Grizzly	12-13				
YFZ 350 Banshee	87-06	DAT06635	23,52	DAT06615	21,76
YFM 350 Warrior	87-04	DAT06635	23,52	DAT06619	23,18
YFM 350 Raptor	04-13	DAT06635	23,52	DAT06650	22,34
YFM 350 Big Bear	87-95	DAT06610	20,14		
YFM 350 Big Bear	96-99	DAT06610	20,14	DAT06607	34,99
YFM 350 Bruin	04-06	DAT06610	20,14	DAT06668	34,40
YFM 350 Grizzly	07-14	DAT06610	20,14	DAT06668	34,40
YFM 350 Grizzly IRS	07-11	DAT06610	20,14	DAT06624	28,52
YFM 350 Wolverine	95-99	DAT06610	20,14	DAT06669	27,78
YFM 350 Wolverine	06-09	DAT06610	20,14	DAT06668	34,40
YFM 400 Big Bear Pro	00-06	DAT06610	20,14	DAT06668	34,40
YFM 400 Grizzly auto. IRS	07-08	DAT06610	20,14	DAT06624	28,52
YFM 400 Kodiak semi.	93-99	DAT06610	20,14	DAT06608	36,75
YFM 400 Kodiak auto.	00-02	DAT06610	20,14	DAT06606	31,16
YFM 400 Kodiak auto.	03-04	DAT06610	20,14	DAT06668	34,40
YFM 400 Kodiak auto. IRS	05-06	DAT06610	20,14	DAT06624	28,52
YFZ 450	04-05	DAT06635	23,52	DAT06645	35,87
YFZ 450	06-09	DAT06635	23,52	DAT06639	57,48
YFZ 450	12-14	DAT06635	23,52	DAT06658	51,13
YFZ 450 R	09-14	DAT06635	23,52	DAT06658	51,13
YFM 450 Grizzly IRS	07-14	DAT06610	20,14	DAT06624	28,52
YFM 450 Kodiak	03-04	DAT06610	20,14	DAT06606	31,16
YFM 450 Kodiak IRS	05-06	DAT06610	20,14	DAT06624	28,52
YFM 450 Wolverine	06-10	DAT06610	20,14		
YXR 450 Rhino	06-09	DAT06610	20,14	DAT06632	21,32
YFM 550 Grizzly	09-14	DAT06624	28,52	DAT06624	28,52
YFM 600 Grizzly	98-01	DAT06610	20,14	DAT06607	34,99
YFM 660 Raptor	01-05	DAT06635	23,52	DAT06615	21,76
YFM 660 Grizzly	2002	DAT06621	19,85	DAT06625	29,40
YFM 660 Grizzly	03-08	DAT06624	28,52	DAT06624	28,52
YXR 660 Rhino	04-07	DAT06610	20,14	DAT06632	21,32
YFM 700 Raptor	06-12	DAT06635	23,52	DAT06639	57,48
YFM 700 Raptor	13-15	DAT06635	23,52		
YFM 700 Grizzly	07-15	DAT06624	28,52	DAT06624	28,52
YXR 700 Rhino FI	08-14	DAT06610	20,14	DAT06632	21,32
YXZ 1000	2016	DAT06632	21,32		

RUEDAS Y NEUMÁTICOS

MOTOR

ADMISIÓN / ESCAPE
REFRIGERACIÓN

ELECTRICO

SUSPENSIÓN / DIRECCIÓN

FRENOS

TRANSMISIÓN

CONTROLES Y MANDOS

CHASIS

ACCESORIOS

XPEED Separadores aluminio

P.V.P
56,86



Separadores de aluminio 1,60kg. y ancho de 45 mm.
Se sirve para dos ruedas, incluye 8 alargadores.

Fáciles de montar y desmontar.

ARTIC CAT	Año	DELANTERO		TRASERO	
		Ataque	Referencia	Ataque	Referencia
250	99-03	4/115	P5228	4/115	P5228
300	98-03	4/115	P5228	4/115	P5228
375	2002	4/115	P5228	4/115	P5228
400	98-05	4/115	P5228	4/115	P5228
DVD 400	04-08	4/144	P5231	4/110	P5228
454	96-98	4/115	P5228	4/115	P5228
500 Todos	98-01	4/115	P5228	4/115	P5228
650i	04-06	4/115	P5228	4/115	P5228
Wild Cat 1000	12-16	4/115	P5228	4/115	P5228

CAN AM	Año	DELANTERO		TRASERO	
		Ataque	Referencia	Ataque	Referencia
Outlander 330	03-09	4/137	P5231	4/137	P5231
Outlander 400	03-11	4/137	P5231	4/137	P5231
DS 450	08-11	4/144	P5233	4/110	P5230
Traxter 500	99-05	4/110	P5228	4/110	P5228
Quest 500	00-05	4/110	P5228	4/110	P5228
DS 650	Todos	4/144	P5233	4/144	P5233
Quest 650	00-05	4/110	P5228	4/110	P5228
Outlander 650	2006	4/137	P5231	4/137	P5231
Outlander 800	2006	4/137	P5231	4/137	P5231
Commander 800	Todos	4/137	P5242	4/137	P5242
Commander 1000	Todos	4/137	P5242	4/137	P5242
Maverick 1000	Todos	4/137	P5242	4/137	P5242

GAS GAS	Año	DELANTERO		TRASERO	
		Ataque	Referencia	Ataque	Referencia
Todos los modelos	03-10	4/144	P5231	4/110	P5228

HONDA	Año	DELANTERO		TRASERO	
		Ataque	Referencia	Ataque	Referencia
TRX 200	90-97	4/110	P5228	4/110	P5228
TRX 250 D & ES Recon	97-06	4/110	P5228	4/110	P5228
TRX 250 EX	00-10	4/144	P5231	4/110	P5228
TRX 300	88-00	4/110	P5228	4/110	P5228
TRX 300 EX	93-10	4/144	P5231	4/110	P5228
Rancher 350 ES	00-04	4/110	P5228	4/110	P5228
Rancher AT 400	2004	4/110	P5228	4/110	P5228
TRX 400 D Foreman	96-06	4/110	P5228	4/110	P5228
TRX 400 EX	99-10	4/144	P5231	4/110	P5228
TRX 450 S & ES Foreman	98-05	4/110	P5228	4/110	P5228
TRX 450 R	04-10	4/144	P5231	4/110	P5228
TRX 500 Foreman	98-11	4/110	P5228	4/110	P5228
TRX 650 Rincon	03-06	4/110	P5228	4/110	P5228
TRX 680 Rincon	06-12	4/110	P5228	4/110	P5228

KAWASAKI	Año	DELANTERO		TRASERO	
		Ataque	Referencia	Ataque	Referencia
KLF 220 Bayou	88-02	4/137	P5231	4/110	P5228

KSF 250 Mojave	87-06	4/156	P5231	4/156	P5231
KLF 300 2X4 Bayou	85-05	4/137	P5231	4/137	P5231
KLF 300 4X4 Bayou	89-05	4/137	P5231	4/137	P5231
KLF 300 B Lakota	95-00	4/156	P5231	4/156	P5231
KVF 300 Prairie	99-05	4/137	P5231	4/137	P5231
Prairie 350	03-10	4/137	P5231	4/137	P5231
KFX 400	03-09	4/144	P5231	4/110	P5228
KLF 400 Bayou	93-05	4/137	P5231	4/137	P5231
Prairie 400	97-05	4/137	P5231	4/137	P5231
KFX 450	08-10	4/144	P5231	4/110	P5228
KVF 650 Prairie	03-06	4/137	P5231	4/137	P5231
Brute Force 650i	2006	4/110	P5228	4/110	P5228
Brute Force 650	05-10	4/137	P5231	4/137	P5231
KFX 700 V-Force	03-06	4/144	P5231	4/137	P5231
KVF 700 Prairie	03-06	4/137	P5231	4/137	P5231
Brute Force 750	05-12	4/110	P5228	4/110	P5228
Mule 500/600	Todos	4/137	P5231	4/137	P5231

KTM	Año	DELANTERO		TRASERO	
		Ataque	Referencia	Ataque	Referencia
450 XC	08-10	4/156	P5231	4/110	P5228
525 XC	08-10	4/156	P5231	4/110	P5228

POLARIS	Año	DELANTERO		TRASERO	
		Ataque	Referencia	Ataque	Referencia
Xplorer 250	00-02	4/156	P5232		
Trail Blazer 250	86-11	4/156	P5232	4/110	P5234
Trail Boss 250	86-11	4/156	P5232	4/110	P5234
Trail Boss 2X4 250	87-99	4/156	P5232	4/110	P5234
Xpress 300	96-99	4/156	P5232		
Xplorer 300	90-99	4/156	P5232		
Magnum 300L	96-99	4/156	P5232		
Magnum 325	02-06	4/156	P5232	4/156	P5232
Trail Boss 325	00-02	4/156	P5232		
Trail Boss 330	2003	4/156	P5232	4/110	P5234
Trail Boss 350L	90-99	4/156	P5232	4/156	P5232
Trail Boss 350	90-99	4/156	P5232		
Trail Boss 400L	90-99	4/156	P5232		
Xpedition 325	00-06	4/156	P5232		
Sportsman 335	99-06	4/156	P5232	4/156	P5232
Magnum 400L 2 WD	96-99	4/156	P5232		
Scrambler 400L	95-08	4/156	P5232	4/100	P5234
Sport 400L	94-99	4/156	P5232		
Sportsman 400L	01-06	4/156	P5232	4/156	P5232
Sportsman 400	95-98	4/156	P5232		
Xplorer 400L	95-03	4/156	P5232		
Xpedition 425	99-06	4/156	P5232		
Diesel 455	99-06	4/156	P5232		
Xplorer 500	96-06	4/156	P5232	4/156	P5232
Magnum 500	02-05	4/156	P5232	4/156	P5232
Outlaw 500	Todos	4/156	P5232	4/110	P5229

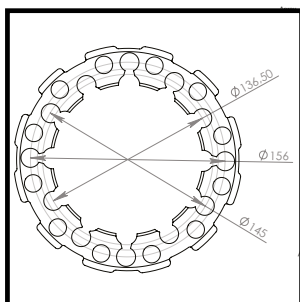

P5231
P5232
P5233

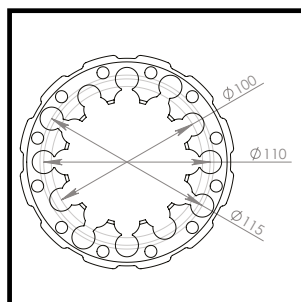

P5228
P5229
P5230

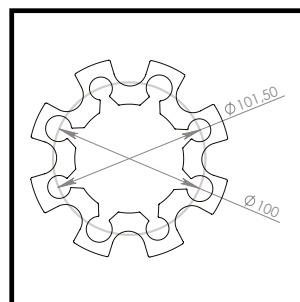

P5234
P5243

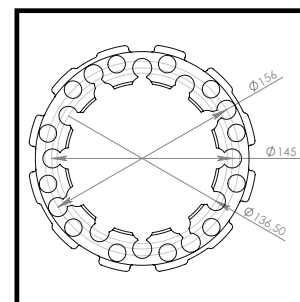

P5242

Modelo	Año	Ataque	Referencia	Ataque	Referencia
Predator 500	2003	4/156	P5232	4/156	P5232
Predator 500	04-07	4/156	P5232	4/110	P5229
Scrambler 500L	97-11	4/156	P5232	4/100	P5234
Sportsman 500	96-06	4/156	P5232	4/156	P5232
Sportsman 600	03-06	4/156	P5232	4/156	P5232
Sportsman 700	02-06	4/156	P5232	4/156	P5232
Sportsman 800	04-06	4/156	P5232	4/156	P5232
Ranger Todos	Todos	4/156	P5232	4/156	P5232
RZR	08-16	4/156	P5232	4/156	P5232

DELANTERO TRASERO

SUZUKI					
Año	Ataque	Referencia	Ataque	Referencia	
Ltz 250 Ozark	02-05	4/144	P5231	4/110	P5228
Eiger 400	02-07	4/110	P5228	4/110	P5228
Ltz 400	03-11	4/144	P5231	4/110	P5228
Ltr 450	06-11	4/144	P5231	4/110	P5228
Vinson 500	02-06	4/110	P5228	4/110	P5228
Twin Peaks 700	04-06	4/137	P5231	4/137	P5231
King Quad 700	05-07	4/110	P5228	4/110	P5228
King Quad 750	08-13	4/110	P5228	4/110	P5228

DELANTERO TRASERO

YAMAHA					
Año	Ataque	Referencia	Ataque	Referencia	
YFS 200 Blaster	88-07	4/156	P5231	4/100	P5243
YFM 250 Raptor	08-11	4/156	P5231	4/115	P5228
YFB 250 Bear Tracker	99-05	4/110	P5228	4/110	P5228
YFM 250 Bruin	05-06	4/110	P5228	4/110	P5228
YFZ 350 Banshee	91-06	4/156	P5231	4/115	P5228
YFM 350 Bruin 4 WD	04-06	4/110	P5228	4/110	P5228
YFM 350 Warrior	87-04	4/156	P5231	4/115	P5228
YFM 350 Raptor	04-11	4/156	P5231	4/115	P5228
YFM 350 Wolverine	95-06	4/110	P5228	4/110	P5228
YFM 350 Big Bear	87-06	4/110	P5228	4/110	P5228
YFM 400 Big Bear	87-06	4/110	P5228	4/110	P5228
YFM 400 Kodiak	93-96	4/110	P5228	4/110	P5228
YFM 450 Kodiak	93-96	4/110	P5228	4/110	P5228
YFM 450 Wolverine	06-08	4/110	P5228	4/110	P5228
YFZ 450	04-13	4/156	P5231	4/115	P5228
YFZ 450 R	09-16	4/156	P5231	4/115	P5228
YXR 450 Rhino	06-09	4/110	P5228	4/110	P5228
YFM 600 Grizzly	98-01	4/110	P5228	4/110	P5228
YFM 660 Grizzly	02-08	4/110	P5228	4/110	P5228
YFM 660 Raptor	01-05	4/156	P5231	4/115	P5228
YXR 700 Rhino	04-07	4/110	P5228	4/110	P5228
YFM 700 Grizzly	07-16	4/110	P5228	4/110	P5228
YFM 700 Kodiak	2016	4/110	P5228	4/110	P5228
YFM 700 Raptor	06-16	4/156	P5231	4/115	P5228
YXE 700 Wolverine	2016	4/110	P5228	4/110	P5228
YXM 700 Viking	14-16	4/110	P5228	4/110	P5228
YXR 700 Rhino	08-13	4/110	P5228	4/110	P5228
YXZ 1000	2016	4/110	P5228	4/110	P5228

Kit 2 tornillos de recambio

Referencia Kit	Para montar en los separadores de referencia
P5315	P5228
P5316	P5229
P5317	P5230
P5315	P5231
P5316	P5232
P5317	P5233
P5321	P5234
P5315	P5242
P5315	P5243

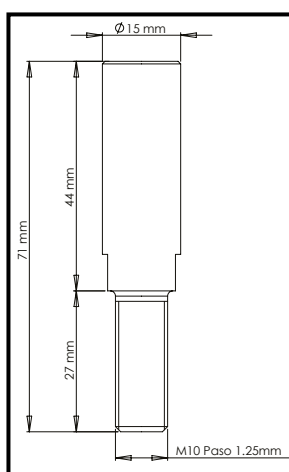

P5315

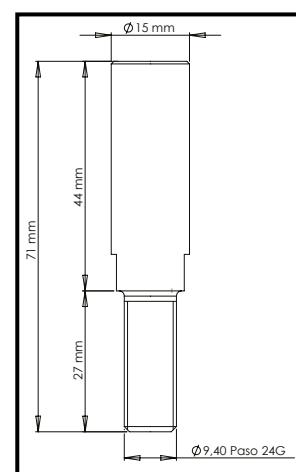

P5316

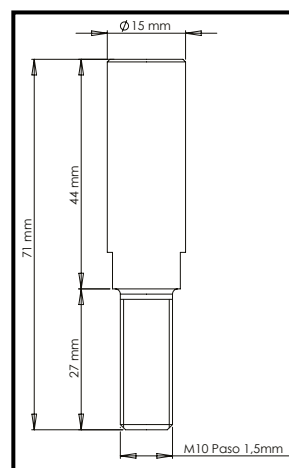

P5317

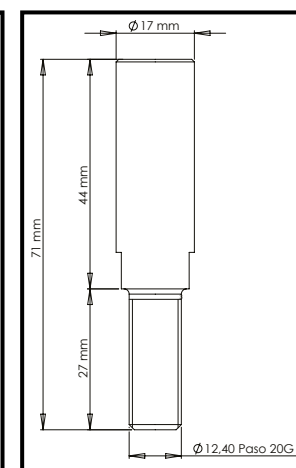

P5321

RUEDAS Y NEUMÁTICOS

MOTOR

ADMISIÓN / ESCAPE
REFRIGERACIÓN

ELECTRICO

SUSPENSIÓN / DIRECCIÓN

FRENOS

TRANSMISIÓN

CONTROLES Y MANDOS

CHASIS

ACCESORIOS

HONDA	Año	DELANTERO		TRASERO		
		Ataque	Referencia 45 mm	Ataque	Referencia 45 mm	Referencia 65 mm
TRX 250 Recon	97-06	4/110	Q045110	4/110	Q045110	Q065110
TRX 250 EX Sportrax	00-10	4/144		4/110	Q045110	Q065110
TRX 300 EX Sportrax	93-10	4/144		4/110	Q045110	Q065110
TRX 350 Rancher	00-04	4/110	Q045110	4/110	Q045110	Q065110
TRX 400 Rancher	2004	4/110	Q045110	4/110	Q045110	Q065110
TRX 400 Foreman	96-06	4/110	Q045110	4/110	Q045110	Q065110
TRX 400 EX Sportrax	99-10	4/144		4/110	Q045110	Q065110
TRX 450 Foreman	98-05	4/110	Q045110	4/110	Q045110	Q065110
TRX 450 R	04-10	4/144		4/110	Q045110	Q065110
TRX 500 Foreman	98-11	4/110	Q045110	4/110	Q045110	Q065110
TRX 650 Rincon	03-06	4/110	Q045110	4/110	Q045110	Q065110
TRX 680 Rincon	06-12	4/110	Q045110	4/110	Q045110	Q065110

KAWASAKI	Año	DELANTERO		TRASERO		
		Ataque	Referencia 45 mm	Ataque	Referencia 45 mm	Referencia 65 mm
KFX 400	03-06			4/110	Q045110	Q065110
KFX 450	08-10			4/110	Q045110	Q065110
KVF 650i Brute Force	2006	4/110	Q045110	4/110	Q045110	Q065110
KVF 750 Brute Force	05-12	4/110	Q045110	4/110	Q045110	Q065110

KTM	Año	DELANTERO		TRASERO		
		Ataque	Referencia 45 mm	Ataque	Referencia 45 mm	Referencia 65 mm
450 XC	08-10			4/110	Q045110	Q065110
525 XC	08-10			4/110	Q045110	Q065110

POLARIS	Año	DELANTERO		TRASERO		
		Ataque	Referencia 45 mm	Ataque	Referencia 45 mm	Referencia 65 mm
Trail Blazer 250	86-11			4/110		Q965100
Trail Boss 250	86-11			4/110		Q965100
Trail Boss 330	2003			4/110		Q965100
Scrambler 400L	95-08			4/100		Q965100
Outlaw 500	Todos			4/110	Q945110	
Predator 500	04-07			4/110	Q945110	
Scrambler 500L	97-11			4/100		Q965100

SUZUKI	Año	DELANTERO		TRASERO		
		Ataque	Referencia 45 mm	Ataque	Referencia 45 mm	Referencia 65 mm
LT-Z 250	02-05			4/110	Q045110	Q065110
LT-A 400 Eiger	02-07	4/110	Q045110	4/110	Q045110	Q065110
LTZ 400	03-11			4/110	Q045110	Q065110
LTR 450	06-11			4/110	Q045110	Q065110
LT-A 500 Vinson	02-07	4/110	Q045110	4/110	Q045110	Q065110
LT-A 700 King Quad	05-07	4/110	Q045110	4/110	Q045110	Q065110
LT-A 750 King Quad	08-13	4/110	Q045110	4/110	Q045110	Q065110

YAMAHA	Año	DELANTERO		TRASERO		
		Ataque	Referencia 45 mm	Ataque	Referencia 45 mm	Referencia 65 mm
YFM 250 Raptor	08-11			4/115	Q045115	Q065115
YFB 250 Bear Tracker	99-05	4/110	Q045110	4/110	Q045110	Q065110
YFM 250 Bruin	05-06	4/110	Q045110	4/110	Q045110	Q065110
YFM 350 Big Bear	87-06	4/110	Q045110	4/110	Q045110	Q065110
YFM 350 Bruin	04-06	4/110	Q045110	4/110	Q045110	Q065110
YFM 350 Grizzly	07-15	4/110	Q045110	4/110	Q045110	Q065110
YFM 350 Raptor	04-13			4/115	Q045115	Q065115
YFM 350 Warrior	87-04			4/115	Q045115	Q065115
YFM 350 Wolverine	95-06	4/110	Q045110	4/110	Q045110	Q065110
YFZ 350 Banshee	91-06			4/115	Q045115	Q065115
YFM 400 Kodiak	93-06	4/110	Q045110	4/110	Q045110	Q065110
YFM 450 Grizzly	07-15	4/110	Q045110	4/110	Q045110	Q065110
YFM 450 Kodiak	03-06	4/110	Q045110	4/110	Q045110	Q065110
YFM 450 Wolverine	06-10	4/110	Q045110	4/110	Q045110	Q065110
YFZ 450	04-13			4/115	Q045115	Q065115
YFZ 450 R	09-15			4/115	Q045115	Q065115
YXR 450 Rhino	04-11	4/110	Q045110	4/110	Q045110	Q065110
YFM 550 Grizzly	09-15	4/110	Q045110	4/110	Q045110	Q065110
YFM 600 Grizzly	98-01	4/110	Q045110	4/110	Q045110	Q065110
YFM 660 Grizzly	02-08	4/110	Q045110	4/110	Q045110	Q065110
YFM 660 Raptor	01-05			4/115	Q045115	Q065115
YXR 660 Rhino	04-07	4/110	Q045110	4/110	Q045110	Q065110
YFM 700 Grizzly	07-15	4/110	Q045110	4/110	Q045110	Q065110
YFM 700 Raptor	06-15			4/115	Q045115	Q065115
YXE 700 Wolverine	2016	4/110	Q045110	4/110	Q045110	Q065110
YXM 700 Viking	14-16	4/110	Q045110	4/110	Q045110	Q065110
YXR 700 Rhino	08-13	4/110	Q045110	4/110	Q045110	Q065110
YXZ 1000	2016	4/110	Q045110	4/110	Q045110	Q065110

XPEED

Separadores de nilón

Fáciles de montar y desmontar; entre 1,55 y 2,25kg. de peso.



P.V.P
58,80

4PLAY

Separadores universales

Pueden usarse para las ruedas delanteras y traseras. Se adapta a todos los Quads / ATV / UTV o Buggies de todas las marcas, a excepción de POLARIS. Fabricado en acero y galvanizado. Peso sólo 1,05kg.

Referencia: DAT06510



P.V.P
45,35

DAT06510

MOTOR

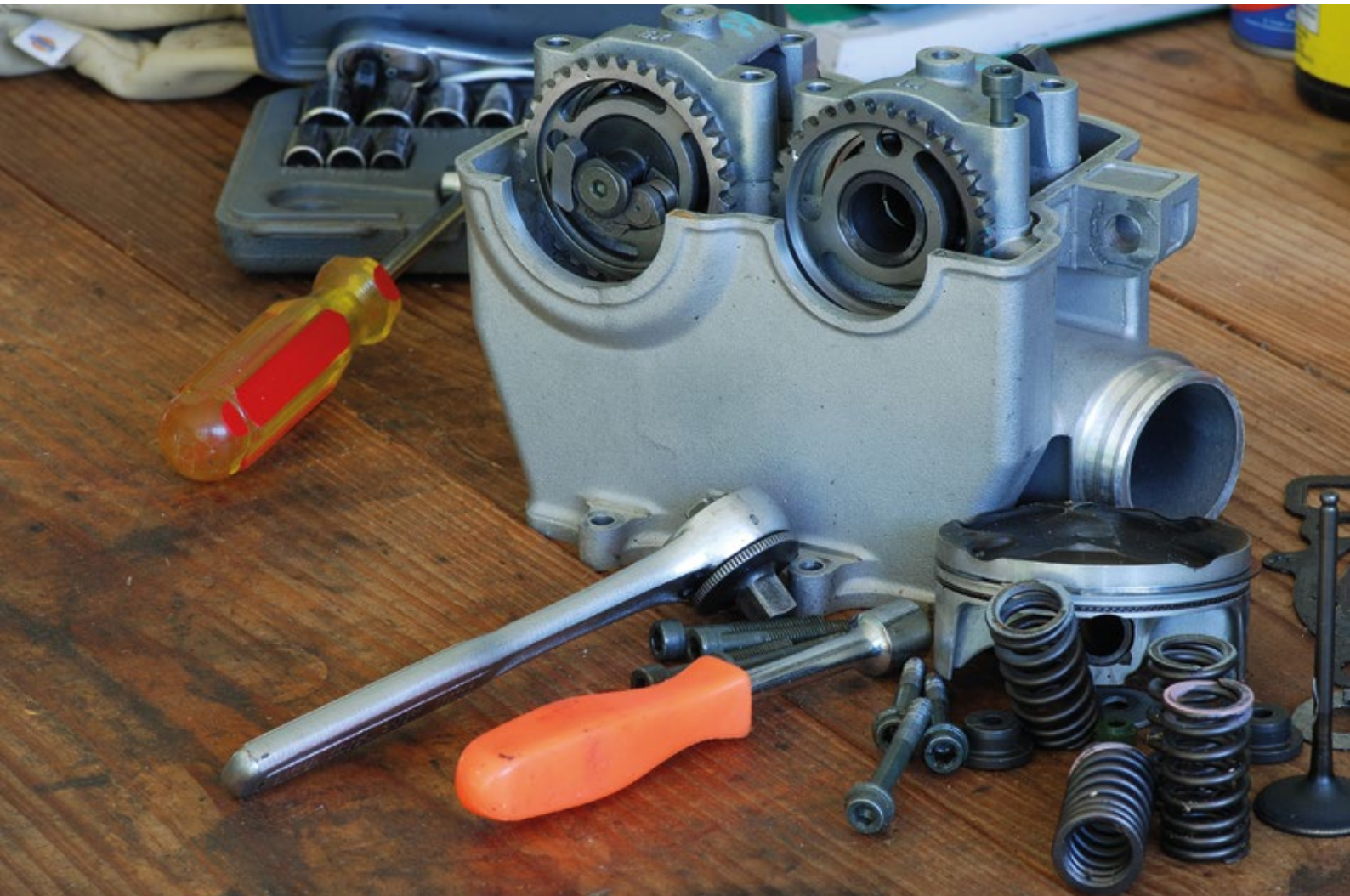



Kit Pistón incluye: Pistón, Segmentos, Bulón, Circlips

HONDA		Cilindro	Kit Pistón	P.V.P.	Juntas Cilindro COMETIC	P.V.P.
• TRX 400 EX 96-09		Diámetro: 85 mm Carrera: 70 mm				
86 mm. Sobremedida. (407 cc)	12.5:1	Rectificar	M2006	185,40		
• TRX 450R 04-05		Diámetro: 94 mm Carrera: 64.8 mm				
94 mm. Calibre STD. (450 cc)	13.0:1	Original	M2017	185,40		
KAWASAKI		Cilindro	Kit Pistón	P.V.P.	Juntas Cilindro COMETIC	P.V.P.
• KFX 450 07-10		Diámetro: 96 mm Carrera: 62.1 mm				
96 mm. Calibre STD. (449 cc)	13.5:1	Original	M4026	185,40		
KTM		Cilindro	Kit Pistón	P.V.P.	Juntas Cilindro COMETIC	P.V.P.
• 450 XC 08-09		Diámetro: 89 mm Carrera: 72 mm				
89 mm. Calibre STD. (450 cc)	13.0:1	Original	M9009	185,40		
• 450 XC 08-09 FULL RACE PISTONS		Diámetro: 89 mm Carrera: 72 mm				
89 mm. Calibre STD. (450 cc)	13.5:1	Original	M9010	185,40		
• 525 XC 08-09		Diámetro: 95 mm Carrera: 72 mm				
95 mm. Calibre STD. (525 cc)	13.0:1	Original	M9012	185,40		
POLARIS		Cilindro	Kit Pistón	P.V.P.	Juntas Cilindro COMETIC	P.V.P.
• RZR 08-09 * Se sirven en kits de dos pistones.		Diámetro: 80 mm Carrera: 75.6 mm				
80 mm. Calibre STD. (760 cc)	12.0:1	Original	M9017	370,80		
80 mm. Calibre STD. (760 cc)	12.5:1	Original	M9018	370,80		
SUZUKI		Cilindro	Kit Pistón	P.V.P.	Juntas Cilindro COMETIC	P.V.P.
• LTR 450 06-10		Diámetro: 95.5 mm Carrera: 62.8 mm				
95.5 mm. Calibre STD. (449 cc)	13.5:1	Original	M4011A	185,40	MC3208	51,20
YAMAHA		Cilindro	Kit Pistón	P.V.P.	Juntas Cilindro COMETIC	P.V.P.
• YFZ 450 03-05 / 06-10*		Diámetro: 95 mm Carrera: 2.440 (63.4 mm) / 2.496 (63.4 mm)				
95 mm. Calbr STD. (439cc / 449cc) / 13.25:1	13.0:1	Original	M1001	185,40	MC3066	48,66
95 mm. Calbr STD. (439cc / 449cc) / 13.75:1	13.5:1	Original	M1002	185,40	MC3066	48,66
• YFM 660 R RAPTOR 02-05 / RHINO 660		Diámetro: 100 mm Carrera: 84 mm				
102 mm. Sobremedida. (686 cc) / 12.0:1		Rectificar	M1017A	185,40	MC7798	58,22
• YFM 700 R RAPTOR 06-10 / RHINO 700FI		Diámetro: 102 mm Carrera: 84 mm				
105 mm. Sobremedida. (727 cc) / 10.75		Rectificar y nicasilar	M1041	185,40		

P.V.P
281,25



Modelo X-PROJECT

Más ligero, faldas de pistón recubiertas para limitar la fricción, reduce el balanceo del pistón y ranuras anti-detonación, ranura acumuladora, lubricadores de doble salida, forjado, cúpulas sostenidas.

P.V.P
231,75



Modelo CP

Ranuras anti-detonación, ranura acumuladora, lubricadores de doble salida, forjado, cúpulas sostenidas.

Kit Pistón incluye: Pistón, Segmentos, Bulón, Circlips



Pistones NAMURA

Pistones de aluminio fundido de anodizado duro, de modo que se optimiza la resistencia mecánica del aluminio al calor. Las faldas tienen revestimiento de Molibdeno (MOS2) y teflón, esto reduce la fricción, extiende la vida útil de los motores; evita que se rayen, ayuda a prevenir daños por la lubricación inadecuada y mejora el sellado. Adicionalmente, en la fabricación de los pistones Namura utilizamos un mayor porcentaje de silicio para obtener una expansión molecular uniforme de los elementos utilizados en su composición.



Segmentos NAMURA

Los segmentos (aros) Namura poseen los mayores estándares de calidad de la industria.



Juntas NAMURA

El kit de juntas de motor Namura dispone, en la gran mayoría de modelos, de todas las juntas, tóricas y retenes del motor entero. El kit de juntas de cilindro dispone de todas las juntas necesarias, para sustituir un pistón.

ARTIC CAT	Año	Medidas (mm)	KIT PISTÓN		SEGMENTOS		JUNTAS CILINDRO		JUNTAS MOTOR	
			Referencia	P.V.P.	Referencia	P.V.P.	Referencia	P.V.P.	Referencia	P.V.P.
400 DVX cilindro nikasil	04-07	89.96	NA30002	135,63	NA30002R	25,58	NA30002T	46,91	NA30002F	116,87
		89.97	NA30002-B		NA30002R					
		89.98	NA30002-C		NA30002R					
		90.46	NA30002-2		NA30002-2R					
		90.96	NA30002-4		NA30002-4R					
91.46	NA30002-6	NA30002-6R								
400	03-08	81,96	NA30010	128,39	NA30010R	22,93	NA30010T	35,25	NA30010F	137,59
		82,46	NA30010-2		NA30010-2R				Manual	.
		82,96	NA30010-4		NA30010-4R				NA30011F	93,69
500**	03-09	87.45	NA30050	160	NA30050R	24,15	NA30050T	33,02	NA30050F	107,33
		87.46	NA30050-B		NA30050R					
		87.47	NA30050-C		NA30050R					
			NA30050-2		NA30050-2R					
			NA30050-4		NA30050-4R					
650 V-TWIN	04-07		NA20065	108,86	NA20065R	22,93	NA20065T	68,74	NA20065F	94,57
			NA20065-2		NA20065-2R					
			NA20065-4		NA20065-4R					
700	06-08	101.96	NA30014	206,17	NA30014R	32,74	NA30015T	95,37	NA30015F	137,56
		101.97	NA30014-B							
		101.98	NA30014-C							
CAN AM	Año	Medidas (mm)	KIT PISTÓN		SEGMENTOS		JUNTAS CILINDRO		JUNTAS MOTOR	
			Referencia	P.V.P.	Referencia	P.V.P.	Referencia	P.V.P.	Referencia	P.V.P.
Outlander 400	03-15	90.958	NA80001	165,33	NA80001R	27,10	NA80002T	73,30		
		91.458	NA80000-2		NA80000-2R					
		91.958	NA80000-4		NA80000-4R					
		92.458	NA80000-6		NA80000-6R					
Outlander 500 Renegade 500	07-15 08-15	81.958	NA80000	125,46	NA80000R	24,15	NA80004T	126,62		
		82.458	NA80000-2		NA80000-2R					
		82.958	NA80000-4		NA80000-4R					
Commander 800 Outlander 800 Renegade 800	11-16 06-15 07-15	90.958	NA80001	165,33	NA80001R	27,10	NA80005T	126,62		
		91.458	NA80000-2		NA80000-2R					
		91.958	NA80000-4		NA80000-4R					
		92.458	NA80000-6		NA80000-6R					

** Pistón o aros Namura no son intercambiables por aros o pistones originales. / En Azul pistones Hyperdryve.

Kit Pistón incluye: Pistón, Segmentos, Bulón, Circlips

HONDA	Año	Medidas (mm)	KIT PISTÓN		SEGMENTOS		JUNTAS CILINDRO		JUNTAS MOTOR	
			Referencia	P.V.P.	Referencia	P.V.P.	Referencia	P.V.P.	Referencia	P.V.P.
TRX 90 Fourtrax	93-16	46.97 47.47 47.97	NA10090 NA10090-2 NA10090-4	74,93	NA10090R NA10090-2R NA10090-4R	16,69	NA10090T	19,89	NA10090F	40,20
TRX 250 Recon	97-01	68.45 68.70 68.95 69.20 69.45	NA10026 NA10026-1 NA10026-2 NA10026-3 NA10026-4	98,3	NA10025R NA10025-1R NA10025-2R NA10025-3R NA10025-4R	20,72	NA10025T	36,94	NA10025F	76,28
TRX 250 EX Sportrax TRX 250 Recon	01-14 02-14	68.45 68.70 68.95 69.20 69.45	NA10025 NA10025-1 NA10025-2 NA10025-3 NA10025-4	109,24	NA10025R NA10025-1R NA10025-2R NA10025-3R NA10025-4R	20,72	NA10026T	41,64	NA10026F	68,08
TRX 300 12" Fourtrax	88-00	73.95 74.45 74.95 75.45	NA10002 NA10002-2 NA10002-4 NA10002-6	89,05	NA10002R NA10002-2R NA10002-4R NA10002-6R	20,44	NA10002T	30,58	NA10002F	67,08
TRX 300 EX Sportrax**	93-09	73.95 74.45 74.95 75.45	NA10005 NA10005-2 NA10005-4 NA10005-6	110,26	NA10002R NA10002-2R NA10002-4R NA10002-6R	20,44	NA10005T	39,54	NA10005F	78,96
TRX 350 Rancher	99-06	78.46 78.71 78.96 79.21 79.46 79.96	NA10007 NA10007-1 NA10007-2 NA10007-3 NA10007-4 NA10007-6	98,77	NA10007R NA10007-1R NA10007-2R NA10007-3R NA10007-4R NA10007-6R	23,18	NA10007T	33,18	NA10007F	54,29
TRX 400 EX Sportrax 11:1 alta compres.**	99-14	84.97 85.47 85.97 86.47	NA10003 NA10003-2 NA10003-4 NA10003-6	102,64	NA10003R NA10003-2R NA10003-4R NA10003-6R	22,93	NA10003T	60,04	NA10003F (99-04) NA10011F (05-14)	88,16 72,94
TRX 400 Foreman	95-03	85.97 86.22 86.47 86.72 86.97	NA10001 NA10001-1 NA10001-2 NA10001-3 NA10001-4	111,31	NA10001R NA10001-1R NA10001-2R NA10001-3R NA10001-4R	24,37	NA10001T	40,42	NA10001F	66,53
TRX 400 Rancher	04-07	84.97 85.47 85.97	NA10040 NA10040-2 NA10040-4	118,69	NA10040R NA10040-2R NA10040-4R	22,93	NA10040T	50,15	NA10040F	58,49
TRX 420 Rancher	07-16	86.48 86.73 86.98 87.23 87.48 87.73 87.98 88.48	NA10042 NA10042-1 NA10042-2 NA10042-3 NA10042-4 NA10042-5 NA10042-6 NA10042-8	102,59	NA10001-2R NA10001-3R NA10001-4R NA10001-5R NA10001-6R NA10001-7R NA10001-8R NA1000110R	24,37	NA10042T Resto modelos (07-16) NA10043T FA / FPA (09-16)	86,73 88,66	NA10042F Resto modelos (07-16) NA10043F FA / FPA (09-16)	93,50 107,89
TRX 450 Foreman	98-04	89.96 90.21 90.46 90.71 90.96 91.46	NA10000 NA10000-1 NA10000-2 NA10000-3 NA10000-4 NA10000-6	118,64	NA10000R NA10000-1R NA10000-2R NA10000-3R NA10000-4R NA10000-6R	25,58	NA10000T	40,42	NA10000F	71,47
TRX 450 R Sportrax 10.2:1 compres.	04-05	93.97 94.47 94.97 95.47	NA10045 NA10045-2 NA10045-4 NA10045-6	112,31	NA10045R NA10045-2R NA10045-4R NA10045-6R	28,07	NA10045T	65,51	NA10045F	104,35
TRX 450 R Sportrax	06-14	95.96 95.97 95.98	NA10046 NA10046-B NA10046-C	185,67	NA10046R	26,63	NA10047T	69,71	NA10047F	105,79
TRX 500 Foreman	05-11	91.96 92.46 92.96 93.46	NA10008 NA10008-2 NA10008-4 NA10008-6	107,50	NA10008R NA10008-2R NA10008-4R NA10008-6R	24,64	NA10050T	72,64	NA10050F	108,25
TRX 500 Rubicon	01-14	91.96 92.46 92.96 93.46	NA10008 NA10008-2 NA10008-4 NA10008-6	107,50	NA10008R NA10008-2R NA10008-4R NA10008-6R	24,64	NA10008T	58,74	NA10008F	109,30
TRX 650 Rincon**	03-05	99.97 100.47 100.97 101.47	NA10009 NA10009-2 NA10009-4 NA10009-6	120,24	NA10009R NA10009-2R NA10009-4R NA10009-6R	28,07	NA10009T	98,39	NA10009F	126,37
TRX 680 Rincon	06-16		NA10012 NA10012-2 NA10012-4 NA10012-6	132,7	NA10012R NA10012-2R NA10012-4R NA10012-6R	30,50	NA10012T	117,48	NA10012F	164,89

** Pistón o aros Namura no son intercambiables por aros o pistones originales. / En Azul pistones Hyperdryve.

Kit Pistón incluye: Pistón, Segmentos, Bulón, Circlips



Juntas NAMURA

Las juntas de Namura son fabricadas con Klingersil, que es tecnológicamente el mejor material para juntas.

KAWASAKI	Año	Medidas (mm)	KIT PISTÓN		SEGMENTOS		JUNTAS CILINDRO		JUNTAS MOTOR	
			Referencia	P.V.P.	Referencia	P.V.P.	Referencia	P.V.P.	Referencia	P.V.P.
KLF 220 Bayou	88-02	66.97 67.47 67.97 68.47	NA20001 NA20001-2 NA20001-4 NA20001-6	83,44	NA20001R NA20001-2R NA20001-4R NA20001-6R	19,48	NA20001T	30,83	NA20001F	58,82
KSF 250 Mojave	87-04	73.95 74.45 74.95 75.45	NA20002 NA20002-2 NA20002-4 NA20002-6	114,69	NA20002R NA20002-2R NA20002-4R NA20002-6R	23,68	NA20002T	65,62	NA20002F	81,15
KLF 250 Bayou	03-11	68.97 69.47 69.97	NA20003 NA20003-2 NA20003-4	64,62	NA20003R NA20003-2R NA20003-4R	15,58	NA20003F	26,03	NA20003F	45,45
KLF 300 Bayou KEF 300 Lakota KVF 300 Prairie	86-04 95-03 99-03	75.95 76.45 76.95 77.45	NA20000 NA20000-2 NA20000-4 NA20000-6	92,56	NA20000R NA20000-2R NA20000-4R NA20000-6R	20,72	NA20000T	30,17	NA20000F	56,61
KVF 360 Prairie	03-12	79.98 80.48 80.98 81.48	NA20036 NA20036-2 NA20036-4 NA20036-6	125,77	NA20036R NA20036-2R NA20036-4R NA20036-6R	24,64	NA20036T	30,83	NA20036F	46,14
KFX 400 cilindro nikasil	03-06	89.96 89.97 89.98 90.46 90.96 91.46	NA30002 NA30002-B NA30002-C NA30002-2 NA30002-4 NA30002-6	135,63	NA30002R NA30002R NA30002R NA30002-2R NA30002-4R NA30002-6R	25,58	NA30002T	46,91	NA30002F	116,87
KXF 450 R	08-14	95.95					NA20004T	69,71	NA20004F	109,38
KVF 650 Prairie KVF 650 Brute Force **se requieren 2 unid.	02-03 05-13	79.96 80.46 80.96	NA20065 NA20065-2 NA20065-4	108,86	NA20065R NA20065-2R NA20065-4R	22,93	NA20065T	68,74	NA20065F (05-13)	96,15
KVF 650i Brute Force	06-13	79.96 80.46 80.96	NA20065 NA20065-2 NA20065-4	108,86	NA20065R NA20065-2R NA20065-4R	22,93	NA20075T	83,02	NA20075F	104,35
KVF 700 Prairie KFX 700 V-Force	04-06 04-10	81.96 82.46 82.96	NA20070 NA20070-2 NA20070-4	112,73	NA20070R NA20070-2R NA20070-4R	25,39	NA20070T	72,50	NA20070F	94,46
KVF 750i Brute Force** KRF 750 Tryx** Cilindro Nikasil	05-14 08-13	85.00	NA20075 NA20075-B NA20075-C	116,68	NA20075R NA20075R NA20075R	25,58	NA20075T	83,02	NA20075F	104,35

KTM	Año	Medidas (mm)	KIT PISTÓN		SEGMENTOS		JUNTAS CILINDRO		JUNTAS MOTOR	
			Referencia	P.V.P.	Referencia	P.V.P.	Referencia	P.V.P.	Referencia	P.V.P.
450 SX	09-10	96.93 96.94 96.95	NX70070 NX70070-B NX70070-C	191,74	NX70070R NX70070R NX70070R	19,98	NX70070T	64,43	NA70070F	52,22
450 XC ATV	08-09	88.95					NA70067T	45,45	NA70067F	89,96
505 SX ATV	09-10	99.94					NX70080T	62,50	NX70080F	89,85

Pistón Hyperdryve

La nueva línea de pistones Hyperdryve está compuesta de un nuevo aluminio hyper-eutectico desarrollado por la Nasa y manipulado para mantener su alta fuerza de tensión hasta 370°C, un 50% más resistente que un pistón de fundición convencional. Esto da Hyperdryve, la fuerza para funcionar bajo condiciones de funcionamiento normalmente reservadas para pistones forjados. Los resultados del porque Namura Hyperdryve es el próximo paso en la evolución de pistones de deportes de motor son claros. Comparacion de Namura Hyperdryve con un típico pistón forjado de aluminio 4032

	Clasificación HRB Temperatura ambiente (Dureza)	Límite de fluencia Temp.perm.a 370° (MPa)	Fuerza de tensión máxima Temp.perm.a 370° (MPa)
Hyperdryve	72	76	97
4032 Forjado	70	31	44

Este aluminio evolutivo combinado con nuestras características ya existentes de cabezas anodizadas* lisas y maquinadas (para mejor reflejo de calor), y faldas recubiertas de MOS2 (dándote arrancadas y frenadas más suaves), concentra las demandas actuales de motores de 4 tiempos 450cc y de 2 tiempos 250cc de altas revoluciones (motores de cross y enduro), a un precio competitivo por debajo de la competencia.

Además de las características y ventajas del pistón habrá una nueva presentación exclusiva para los pistones Hyperdryve Namura. En bote cilíndrico ofreciendo una fácil apertura, de rosca en la parte superior. Dentro están los compartimientos de espuma de protección individuales sosteniendo el pistón, bulón, clips y aros junto con un folleto informativo que enumera las características y ventajas de los pistones Hyperdryve.

Kit Pistón incluye: Pistón, Segmentos, Bulón, Circlips



Juntas NAMURA

Las juntas de Namura son fabricadas con Klingersil, que es tecnológicamente el mejor material para juntas.

POLARIS	Año	Medidas (mm)	KIT PISTÓN		SEGMENTOS		JUNTAS CILINDRO		JUNTAS MOTOR	
			Referencia	P.V.P.	Referencia	P.V.P.	Referencia	P.V.P.	Referencia	P.V.P.
Trail Boss 250	85-99	71.96	NA50000		NA50000R					
Trail Blazer 250	90-06	72.46	NA50000-2	86,51	NA50000-2R	16,55	NA50000T	16,77	NA50000F	20,31
Xplorer 250	00-02	73.46	NA50000-6		NA50000-4R					
rodamiento pistón		18X23X22	N095051		NA50000-6R					
300 L	94-00	74.47	NA50003		NA50003R					
Xplorer 300	96-99	74.97	NA50003-2		NA50003-2R					
Xpess 300	96-99	75.47	NA50003-4	98,66	NA50003-4R	16,33	NA50003T	19,70	NA50003F	25,80
rodamiento pistón		18X23X22	N095051		NA50003-6R					
Hawkeye 300	06-11	77.70	NA50013		NA50013R					
Soprsman 300	08-10	78.20	NA50013-2	112,34	NA50013-2R	21,69	NA50013T	52,58	NA50013F	75,43
		78.70	NA50013-4		NA50013-4R					
		79.20	NA50013-6		NA50013-6R					
Magnum 325	00-02	77.95	NA50024		NA50024R					
Trail Boss 325	00-02	78.45	NA50024-2	98,55	NA50024-2R	21,69	NA50025T	28,84	NA50025F	72,62
Xpedition 325	00-02	78.95	NA50024-4		NA50024-4R					
		79.45	NA50024-6		NA50024-6R					
Magnum 330	03-06	78.45	NA50025		NA50024-2R					
Trail Blazer 330	08-13	78.95	NA50025-2	102,34	NA50024-4R	21,69	NA50025T	28,84	NA50025F	72,62
Trail Boss 330	03-13	79.45	NA50025-4		NA50024-6R					
Sportsman 335	99-00						NA50023T	38,13	NA50023F	54,01
Trail Boss 350	90-94	79.95	NA50001		NA50001R					
		80.45	NA50001-2	104,71	NA50001-2R					
		80.95	NA50001-4		NA50001-4R	18,72	NA50001T	17,80	NA50001F	49,32
rodamiento pistón		81.45	NA50001-6		NA50001-6R					
		18X23X23.8	N09B0021	8,56						
400 L	94-03	82.94	NA50002		NA50002R					
Sport 400	93-02	83.44	NA50002-2	90,37	NA50002-2R					
Scrambler 400	95-02	83.94	NA50002-4		NA50002-4R	18,72	NA50002T	22,63	NA50002F	62,97
Trail Blazer 400	94-03	84.44	NA50002-6		NA50002-6R					
rodamiento pistón		18X23X23.8	N09B0021	8,56						
Sportsman 400	01-05									
Sportsman 400 HO	08-14	87.89	NA50026		NA50026R					
Hawkeye 400 HO	11-14	88.39	NA50026-2	123,25	NA50026-2R	22,93	NA50026T	77,58	NA50026F	98,66
Ranger 400	03-14	88.89	NA50026-4		NA50026-4R					
Sportsman 450	06-07									
		98.94	NA50019		NA50019R					
		99.44	NA50019-2		NA50019R					
Sportsman 450	2016	99.94	NA50019-4	127,56	NA50019R	25,39				
		100.44	NA50019-6		NA50019R					
Xplorer 500	96-03	91.97	NA50004		NA50004R					
Magnum 500	96-03	92.47	NA50004-2		NA50004-2R					
Sportsman 500	96-13	92.97	NA50004-4	118,83	NA50004-4R	24,15	NA50004T	40,83	NA50004F	94,80
Scrambler 500	96-13	93.47	NA50004-6		NA50004-6R					
Predator 500	03-07	99.15	NA50005		NA50005R					
Outlaw 500	06-07	99.65	NA50005-2	121,07	NA50005-2R	26,63	NA50005T	74,87	NA50005F	94,99
		100.15	NA50005-4		NA50005-4R					
		100.65	NA50005-6		NA50005-6R					
Sportsman 550	09-14	96.57	NA50011		NA50011R					
		97.07	NA50011-2	131,57	NA50011-2R	25,39	NA50011T	86,23	NA50011F	156,96
		97.57	NA50011-4		NA50011-4R					
		98.07	NA50011-6		NA50011-6R					
Sportsman 570	14-16	98.94	NA50019		NA50019R				NA50019F	156,18
Ranger 570	14-16	99.44	NA50019-2	127,56	NA50019R	25,39	NA50019T	98,36	RZR (12-15)	
RZR 570	12-16	99.94	NA50019-4		NA50019R				Ranger (14-15)	
		100.44	NA50019-6		NA50019R				NA50020F	156,18
									Sport. (14-15)	
Sportsman 700**	02-08	79.96	NA50070		NA50080R		NA50070T	67,97	NA50070F	95,90
Ranger 700**	05-09	79.97	NA50070-B	103,14	NA50080R	26,83	Sport. (02-03)	121,35	Sport. (02-03)	148,20
		79.98	NA50070-C		NA50080R		NA50080T		NA50080F	
							Sport. (04-08)		Sport. (04-08)	
							Ranger(05-09)		Ranger(05-09)	
Sportsman 800	05-15									
Ranger 800	10-15	79.95	NA50080		NA50080R					
RZR 800	09-10	79.96	NA50080-B	96,12	NA50080R	26,83	NA50080T	121,35	NA50080F	148,20
RZR 800 S	2010	79.97	NA50080-C		NA50080R					
RZR 800 S EPS Inter.	2011									
Sportsman 800 HO	08-09									
RZR 800	11-14	79.95	NA50081		NA50080R					
RZR 800 S HO	09/11-14	79.96	NA50081-B	101,87	NA50080R	26,83				
RZR 800 4 HO	10-14	79.97	NA50081-C		NA50080R					
Sportsman 850	09-15	86.93	NA50012		NA50012R					
Scrambler 850	13-15	86.94	NA50012-B	109,22	NA50012-2R	24,15	NA50012T	118,94	NA50012F	219,73
		86.95	NA50012-C		NA50012-4R					
		87.43	NA50012-4		NA50012-6R					
		87.93	NA50012-2							
		88.43	NA50012-6							

Kit Pistón incluye: Pistón, Segmentos, Bulón, Circlips



SUZUKI	Año	Medidas (mm)	KIT PISTÓN		SEGMENTOS		JUNTAS CILINDRO		JUNTAS MOTOR	
			Referencia	P.V.P.	Referencia	P.V.P.	Referencia	P.V.P.	Referencia	P.V.P.
LT 80 QuadSport	87-06		NA30080 NA30080-2 NA30080-4	44,43	NA30080R NA30080-2R NA30080-4R	9,53	NA30080T	7,82	NA30080F	33,24
rodamiento pistón		12X16X15.8	N09B0001	7,29						
LT 160 Quadrunner	89-04	57.97 58.47 58.97	NA30160 NA30160-2 NA30160-4	81,95	NA30160R NA30160-2R NA30160-4R	16,74	NA30160T	24,81	NA30160F	49,95
LT-F 250 Quadrunner LT-Z 250 QuadSport LT-F 250 Ozark	88-02 04-09 02-12	65.97 66.47 66.97 67.47	NA30000 NA30000-2 NA30000-4 NA30000-6	81,73	NA30000R NA30000-2R NA30000-4R NA30000-6R	21,88	NA30008T LT-Z 250	23,57	NA30008F LT-Z 250	42,74
LT 300 F King Quad LT 4 WD King Quad	99-02 91-98	68.47 68.97 69.47	NA30001 NA30001-2 NA30001-4	91,56	NA30001R NA30001-2R NA30001-4R	19,48	NA30001T	20,91	NA30001F	39,34
LT-Z 400	03-14	89.96 89.97 89.98 90.46 90.96 91.46	NA30002 NA30002-B NA30002-C NA30002-2 NA30002-4 NA30002-6	135,63	NA30002R NA30002R NA30002R NA30002-2R NA30002-4R NA30002-6R	25,58	NA30002T	46,91	NA30002F (03-08) NA30013F (09-13)	116,87 97,23
LT-A 400 Eiger** LT-F 400 Eiger** LT-A 400 King Quad** LT-F 400 King Quad**	02-07 02-07 08-16 08-16	81.96 82.46 82.96	NA30010 NA30010-2 NA30010-4	128,39	NA30010R NA30010-2R NA30010-4R	22,93	NA30010T	35,25	NA30010F (02-14) LT-F 400 NA30011F (02-07) LT-A 400 NA30012F (08-14) LT-A 400	137,59 93,69 137,59
LT-R 450	06-11						NA30005T	64,37	NA30005F	105,79
LT-F 500 Quadrunner** LT-A 500 Quadmaster**	98-02 00-01	87.45 87.46 87.47 87.95 88.45	NA30051 NA30051-B NA30051-C NA30051-2 NA30051-4	160,58	NA30050R NA30050R NA30050R NA30050-2R NA30050-4R	24,15	NA30050T	33,02	NA30049F LT-F NA30050F LT-A	90,43 107,37
LT-A 500 F Vinson** LT-F 500 F Vinson**	02-07 02-07	87.45 87.46 87.47 87.95 88.45	NA30050 NA30050-B NA30050-C NA30050-2 NA30050-4	160	NA30050R NA30050R NA30050R NA30050-2R NA30050-4R	24,15	NA30050T	33,02	NA30049F LT-F NA30050F LT-A	90,43 107,37
LT-A 500 King Quad cilindro SCEM	09-16	87.45 87.46 87.47 87.95 88.45	NA30053 NA30053-B NA30053-C NA30053-2 NA30053-4	157,43	NA30050R NA30050R NA30050R NA30050-2R NA30050-4R	24,15	NA30053T	98,88	NA30053F	162,01
LT-A 700 King Quad	05-07	101.96 101.97 101.98	NA30014 NA30014-B NA30014-C	206,17	NA30014R NA30014R NA30014R	32,74	NA30015T	95,37	NA30015F	137,56
LT-A 700 King Quad Sobremedida a 750cc	05-07	103.96 103.97 103.98	NA30015 NA30015-B NA30015-C	207,66	NA30015R NA30015R NA30015R	32,74	NA30015T	95,37	NA30015F	137,56
LT-V 700 Twin Peaks	04-05	81.96 82.46 82.96	NA20070 NA20070-2 NA20070-4	112,73	NA20070R NA20070-2R NA20070-4R	25,39	NA20070T	72,50	NA20070F	94,46
LT-A 750 King Quad	08-16	103.96 103.97 103.98	NA30015 NA30015-B NA30015-C	207,66	NA30015R NA30015R NA30015R	32,74	NA30015T (08-13)	95,37	NA30015F (08-13)	137,56

** Pistón o aros Namura no son intercambiables por aros o pistones originales / En Azul pistones Hyperdryve.

Los nuevos kits de pistones Hyperdryve se entregan en un embalaje de última generación.



Kit Pistón incluye: Pistón, Segmentos, Bulón, Circlips

YAMAHA	Año	Medidas (mm)	KIT PISTÓN		SEGMENTOS		JUNTAS CILINDRO		JUNTAS MOTOR	
			Referencia	P.V.P.	Referencia	P.V.P.	Referencia	P.V.P.	Referencia	P.V.P.
YFA 1 125 Breeze	91-04		NA40019		NA40019R					
YFM 125 Grizzly	04-13		NA40019-2	78,91	NA40019-2R	17,85	NA40019T	23,57	NA40019F	57,27
			NA40019-4		NA40019-4R					
YFS 200 Blaster alta compres.	88-06	65.94 66.44 66.94 67.44 67.94	NA40002 NA40002-2 NA40002-4 NA40002-6 NA40002-8	90,57	NA40002R NA40002-2R NA40002-4R NA40002-6R NA40002-8R	15,58	NA40002T	23,10	NA40002F	32,93
rodamiento pistón		16x21x22.5	N09B0051	8,87						
YFS 200 Blaster original	88-06	65.92 66.42 66.92 67.42 67.92	NA40003 NA40003-2 NA40003-4 NA40003-6 NA40003-8	82,36	NA40002R NA40002-2R NA40002-4R NA40002-6R NA40002-8R	15,58	NA40002T	23,10	NA40002F	32,93
rodamiento pistón		16x21x22.5	N09B0051	8,87						
YFS 200 Blaster original	88-06	66 66.25 66.50 66.75	E1834650 E1834651 E1834652 E1834653	52,08			NA40002T	23,10	NA40002F	32,93
rodamiento pistón		16x21x22.5	N09B0051	8,87						
YFB 250 Timberwolf	92-98	70.95	NA40015		NA40015R					
YFM 250 Bear Tracker	99-04	71.45	NA40015-2		NA40015-2R					
YFM 250 Bruin	05-06	71.95	NA40015-4	82,28	NA40015-4R	20,45	NA40015T	35,75	NA40015F	61,00
YFM 250 Big Bear	07-09	72.95	NA40015-6		NA40015-6R					
YFZ 350 Banshee** alta compres.	87-06	63.94 64.19 64.44 64.69 64.94 65.19 65.44 65.69 65.94 66.19 66.44	NA40000 NA40000-1 NA40000-2 NA40000-3 NA40000-4 NA40000-5 NA40000-6 NA40000-7 NA40000-8 NA40000-9 NA40000-10	89,63	NA40000RN NA400001RN NA400002RN NA400003RN NA400004RN NA400005RN NA400006RN NA400007RN NA400008RN NA400009RN NA4000010RN	15,58	NA40001T	23,35	NA40001F	44,15
rodamiento pistón		16x21x22.5	N09B0051	8,87						
YFZ 350 Banshee original	87-06	63.95 64.45 64.70 64.95 65.45	NA40001 NA40001-2 NA40001-3 NA40001-4 NA40001-6	98,58	NA40000R NA40000-2R NA40000-3R NA40000-4R NA40000-6R	16,69	NA40001T	23,35	NA40001F	44,15
rodamiento pistón		16x21x22.5	N09B0051	8,87						
YFM 350 Big Bear	87-99	82.95 83.45 83.95 84.45	NA40005 NA40005-2 NA40005-4 NA40005-6	104,71	NA40005R NA40005-2R NA40005-4R NA40005-6R	23,18	NA40005T	38,79	NA40005F 2x4 (87-98) NA40006F 4x4 (97-99)	57,69 81,92
YFM 350 Bruin	04-06	82.95	NA40005		NA40005R				NA40006F	81,92
YFM 350 Grizzly	07-14	83.45	NA40005-2		NA40005-2R				Wolverine(95-05)	
YFM 350 Wolverine	95-09	83.95 84.45	NA40005-4 NA40005-6	104,71	NA40005-4R NA40005-6R	23,18	NA40005T	38,79	NA40017F resto	51,17
YFM 350 Raptor	04-13	82.95	NA40005		NA40005R					
YFM 350 Warrior	87-04	83.45 83.95 84.45	NA40005-2 NA40005-4 NA40005-6	104,71	NA40005-2R NA40005-4R NA40005-6R	23,18	NA40005T	38,79	NA40005F	57,69
YFM 400 Big Bear "semi."	00-12	83.00 83.25	NA40006 NA40006-1		NA40005R NA40005-1R				NA40005F (93-98)	57,69
YFM 400 Kodiak "semi."	93-99	83.50 84.00 84.50	NA40006-2 NA40006-4 NA40006-6	103,47	NA40005-2R NA40005-4R NA40005-6R	23,18	NA40005T	38,79	NA40006F (99-10)	81,92
YFM 400 Grizzly	07-08	84.42	NA40008		NA40008R					
YFM 400 Kodiak "autom."	00-06	84.92 85.42	NA40008-2 NA40008-4	117,81	NA40008-2R NA40008-4R	23,18	NA40008T	55,23	NA40008F	93,08
YFM 450 Kodiak	03-06	84.45	NA40011		NA40011R					
YFM 450 Grizzly	07-14	84.95	NA40011-2		NA40011-2R					
YXR 450 Rhino	06-10	85.45	NA40011-4	123	NA40011-4R	22,93	NA40008T	55,23	NA40008F	93,08
YFM 450 Wolverine	06-10									
YFZ 450	04-13	94.95	NA40009H		NA40009R		NA40009T	55,23	NA40009F	75,92
YFZ 450 R	09-16	94.96	NA40009-BH	171,29	NA40009R	25,39	YFZ 450	46,66	YFZ 450	
cilindro nikasil		94.97	NA40009-CH		NA40009R		NA40014T (09-14) YFZ450R		NA40014F (09-14)YFZ450R	96,04
YFM 550 Grizzly	09-14						NA40021T	79,54	NA40021F	115,96
YFM 600 Grizzly	98-01	95.00 95.50 96.00	NA40007 NA40007-2 NA40007-4	128,33	NA40007R NA40007-2R NA40007-4R	25,58	NA40007T	60,81	NA40007F	110,24
YFM 660 Raptor	01-05	99.97	NA40004		NA40004R				NA40004F	134,00
YFM 660 Grizzly	02-08	100.47	NA40004-2		NA40004-2R		NA40004T (Raptor)	68,93	NA40004F (Raptor)	
YXR 660 Rhino	04-07	100.97 101.47	NA40004-4 NA40004-6	123,94	NA40004-4R NA40004-6R	27,79	NA40010T	87,72	NA40010F	125,63
YFM 700 Raptor	06-16	101.97	NA40012		NA40012R				NA40012F (Raptor)	119,91
YFM 700 Grizzly	07-15	101.98	NA40012-B	172,87		31,36	NA40012T	84,98	NA40013F	
YXR 700 Rhino	08-13	101.99	NA40012-C						NA40013F (Grizzly-Rhino)	117,28

** Pistón o aros Namura no son intercambiables por aros o pistones originales. / En Azul pistones Hyperdryve.



Cilindros STD o con aumento de cilindrada

Cilindros Nicasil. La manera más rápida y económica de reparar tu moto. Kit de pistón no incluido.



YAMAHA	Año	Referencia	Descripción	P.V.P
YFZ 450	04-05	DMX09151	estandar 95mm (439cc)	209,62
YFZ 450	04-05	DMX091511	98mm (de 439cc a 468cc)	233,03
YFZ 450	06-13	DMX09151	estandar 95mm (449cc)	209,62
YFZ 450	06-13	DMX091511	98mm (de 449cc a 478cc)	233,03
YFZ 450 R	09-13	DMX09159	estandar 95mm (449cc)	220,86
YFZ 450 R	09-13	DMX091591	98mm (de 449cc a 478cc)	233,03



Kit de cilindro con aumento de cilindrada

Lo más rápido, fiable y económico, sustituir el cilindro y pistón por el kit de cilindrada, ahorrarás tiempo y dinero, pero también aumentarás cilindrada, convirtiendo tu vieja moto en un vehículo con nuevas prestaciones. El pistón Namura supera ampliamente las características y calidades originales.

El Kit se entrega con cilindro, pistón, segmentos, bulón, circlips y kit de juntas.

* DAT09463K Es necesario mandrinar 0,8mm el cárter para poder alojar la camisa.

** DAT094621K Usar junta de culata gruesa (la delgada sólo para moto).



DAT094621K

			KIT DE CILINDRO		CILINDRO DE RECAMBIO		KIT PISTÓN RECAMBIO		JUNTAS DE CILINDRO	
	Año	Descripción	Referencia	P.V.P.	Referencia	P.V.P.	Referencia	P.V.P.	Referencia	P.V.P.
HONDA										
TRX 300 EX	93-09	dimensionado 80 mm	DAT094511K	308,12			NA10010	106,59	NA10010T	18,48
TRX 400 Sportrax	99-09	89 mm (de 400 a 440cc)	DAT09463K	308,12			NA10004	123,25	NA10004T	50,50
KAWASAKI										
KFX 400	03-06	94 mm (de 400 a 435cc)	**DAT094621K	361,87			NA30002-16	138,06	NA3000216T	81,59
							NA3000216B	138,06	NA3000216T	81,59
							NA3000216C	138,06	NA3000216T	81,59
SUZUKI										
LT-Z 400	03-12	94 mm (de 400 a 435cc)	**DAT094621K	361,87			NA30002-16	138,06	NA3000216T	81,59
							NA3000216B	138,06	NA3000216T	81,59
							NA3000216C	138,06	NA3000216T	81,59
YAMAHA										
YFZ 450	04-05	Std. 95 mm (439cc)	DAT09470K	394,98	DMX09151	209,62	NA40009H	163,62	NA40009T	55,23
							NA40009-BH	163,62	NA40009T	55,23
							NA40009-CH	163,62	NA40009T	55,23
YFZ 450	06-13	Std. 95 mm (449cc)	DAT09470K	394,98	DMX09151	209,62	NA40009H	163,62	NA40009T	55,23
							NA40009-BH	163,62	NA40009T	55,23
							NA40009-CH	163,62	NA40009T	55,23
YFZ 450 R	09-13	Std. 95 mm (449cc)	DAT09472K	394,98						

Rascador de juntas



Referencia	P.V.P.
DUP12290	6,84

VÁLVULAS DE ADMISIÓN VÁLVULAS DE ESCAPE

CAN AM	Año	Referencia	P.V.P.	Referencia	P.V.P.
330 Outlander	04-05	DAU09017I	22,32	DAU09017E	26,78
400 Outlander	03-15	DAU09017I	22,32	DAU09017E	26,78
500 Renegade	09-15	DAU09017I	22,32	DAU09017E	26,78
650 Outlander	06-15	DAU09017I	22,32	DAU09017E	26,78
800 Outlander	06-15	DAU09017I	22,32	DAU09017E	26,78
800 Commander	11-15	DAU09017I	22,32	DAU09017E	26,78
800 Renegade	07-15	DAU09017I	22,32	DAU09017E	26,78
1000 Outlander	2014	DAU09017I	22,32	DAU09017E	26,78
1000 Renegade	2014	DAU09017I	22,32	DAU09017E	26,78
1000 Commander	2014	DAU09017I	22,32	DAU09017E	26,78

VÁLVULAS DE ADMISIÓN VÁLVULAS DE ESCAPE

HONDA	Año	Referencia	P.V.P.	Referencia	P.V.P.
TRX 250 X Fourtrax	87-92	DAU09003I	19,22	DAU09003E	20,70
TRX 250 Recon	97-01	DAU09004I	17,55	DAU09004E	20,16
TRX 250 Recon	02-14	DAU09005I	18,50	DAU09005E	21,35
TRX 250 EX Sportrax	01-14	DAU09006I	19,50	DAU09006E	22,40
TRX 300 EX Sportrax	93-09	DAU09003I	19,22	DAU09003E	20,70
TRX 350 Rancher	00-06	DAU09009I	18,90	DAU09009E	22,00
TRX 400 Sportrax	99-14	DAU09011I	19,30	DAU09011E	22,95
TRX 420 Rancher	09-13	DAU09014I	20,10	DAU09014E	22,15
TRX 450 Foreman	98-02	DAU09012I	20,30	DAU09012E	22,80
TRX 450 R	04-05	DAU09013I	19,30	DAU09013E	25,45
TRX 450 R	06-14	DXU09502I	24,61	DXU09503E	24,29
TRX 500 Rubicon	01-14	DAU09011I	19,30	DAU09011E	22,95
TRX 650 Rincon	03-05	DAU09015I	19,90	DAU09015E	22,00
TRX 680 Rincon	06-14	DAU09015I	19,90	DAU09015E	22,00

VÁLVULAS DE ADMISIÓN VÁLVULAS DE ESCAPE

KAWASAKI	Año	Referencia	P.V.P.	Referencia	P.V.P.
KLF 220 Bayou	88-02	DAU09021I	18,90	DAU09021E	24,25
KLF 250 Bayou	03-11	DAU09021I	18,90	DAU09021E	24,25
KSF 250 Mojave	87-04	DAU09022I	18,50	DAU09022E	21,35
KVF 300 Brute Force	12-14	DAU09020I	20,55	DAU09020E	22,15
KVF 300 Prairie	99-02	DAU09020I	20,55	DAU09020E	22,15
KVF 360 Prairie	03-12	DAU09026I	19,90	DAU09026E	22,80
KLF 400 Bayou	93-99	DAU09024I	18,50	DAU09024E	21,35
KVF 400 Prairie	98-02	DAU09024I	18,50	DAU09024E	21,35
KFX 400	03-06	DAU09025I	18,90	DAU09025E	23,75
KFX 450 R	08-13	DXU09164I	22,10	DXU09164E	24,15
KVF 650 Brute Force	05-13	DAU09027I	20,55	DAU09027E	22,00
KVF 650i Brute Force	06-14	DAU09027I	20,55	DAU09027E	22,00
KVF 650 Prairie	02-03	DAU09027I	20,55	DAU09027E	22,00
KFX 700 V-Force	04-09	DAU09027I	20,55	DAU09027E	22,00
KVF 700 Prairie	04-06	DAU09027I	20,55	DAU09027E	22,00
KRF 750 Teryx	08-12	DAU09027I	20,55	DAU09027E	22,00
KVF 750i Brute Force	05-14	DAU09027I	20,55	DAU09027E	22,00

VÁLVULAS DE ADMISIÓN VÁLVULAS DE ESCAPE

POLARIS	Año	Referencia	P.V.P.	Referencia	P.V.P.
300 Sportsman	08-10	DAU09194I	21,04	DAU09194E	22,68
325 Magnum	2002	DAU09194I	21,04	DAU09194E	22,68
330 ATP	04-05	DAU09194I	21,04	DAU09194E	22,68
330 Hawkeye	06-10	DAU09194I	21,04	DAU09194E	22,68
330 Magnum	03-05	DAU09194I	21,04	DAU09194E	22,68
330 Trail Blazer	08-13	DAU09194I	21,04	DAU09194E	22,68
330 Trail Boss	02-13	DAU09194I	21,04	DAU09194E	22,68
400 Hawkeye	11-14	DAU09193I	21,04	DAU09193E	22,68
400 Ranger	10-14	DAU09193I	21,04	DAU09193E	22,68
400 Sportsman	01-04	DAU09193I	21,04	DAU09193E	22,68
400 Sportsman	08-14	DAU09193I	21,04	DAU09193E	22,68
425 Xpedition	00-02	DAU09193I	21,04	DAU09193E	22,68
450 Sportsman	06-07	DAU09193I	21,04	DAU09193E	22,68
500 ATP	04-05	DAU09193I	21,04	DAU09193E	22,68
500 Magnum	96-03	DAU09193I	21,04	DAU09193E	22,68
500 Ranger	06-13	DAU09193I	21,04	DAU09193E	22,68
500 Scrambler	97-12	DAU09193I	21,04	DAU09193E	22,68
500 Sportsman	00-08	DAU09193I	21,04	DAU09193E	22,68
500 Worker	99-01	DAU09193I	21,04	DAU09193E	22,68
500 Xplorer	1997	DAU09193I	21,04	DAU09193E	22,68
550 Sportsman	09-14	DAU09191I	21,04	DAU09191E	22,68
570 RZR	12-15	DAU09190I	20,80	DAU09190E	23,20
570 Ranger	14-16	DAU09190I	20,80	DAU09190E	23,20
570 Sportsman	14-16	DAU09190I	20,80	DAU09190E	23,20
570 Sportsman ACE	2015	DAU09190I	20,80	DAU09190E	23,20
700 Ranger	2009	DAU09195I	20,30	DAU09195E	23,68
700 Sportsman X2 EFI	2008	DAU09195I	20,30	DAU09195E	23,68
800 Ranger	10-15	DAU09195I	20,30	DAU09195E	23,68
800 RZR	09-14	DAU09195I	20,30	DAU09195E	23,68
800 RZR "S"	09-14	DAU09195I	20,30	DAU09195E	23,68



Válvulas de admisión y escape



- Válvulas de escape:
- Exceden la calidad original
 - Fabricadas en acero inoxidable (SUH35HT)

- Válvulas de admisión:
- Especificaciones originales
 - Fabricadas en acero (SUH3)

Válvulas forjadas, construidas de una pieza, pulidas con radio modificado, "nitride coating" que reduce la fricción y alarga la vida.

ESPECIFICACIONES

Tolerancia (mm)	+/-0.10	+/-0.01	+/-0.20
Referencia	Diámetro cabeza	Diámetro tija	altura total
DAU09000E	20	5	65,4
DAU09000I	23	5	65,8
DAU09002E	28	5,5	89,95
DAU09002I	32	5,5	91,3
DAU09003E	22,5	5,45	93
DAU09003I	25,5	5,45	93,6
DAU09004E	27	5,5	82,2
DAU09004I	31	5,5	81,8
DAU09005E	27	5,5	88,5
DAU09005I	31,5	5,5	89
DAU09006E	26,8	5,5	89,4
DAU09006I	31,4	5,5	89,8
DAU09007I	32	5,45	91,3
DAU09008E	27,5	5,5	90,52
DAU09008I	31	5,5	93,07
DAU09009E	28	5,46	81,88
DAU09009I	34	5,45	81,4
DAU09010E	28	5,5	82
DAU09010I	34	5,5	81,4
DAU09011E	29	5,45	101,2
DAU09011I	33	5,45	102,7
DAU09012E	30	5,5	82
DAU09012I	35	5,5	81,4
DAU09013E	30	5,5	84,3
DAU09013I	36	5,48	84,6
DAU09014E	33	6	91,15
DAU09014I	38	6	94,4
DAU09015E	30,5	5,45	101
DAU09015I	34,5	5,5	102,6
DAU09016E	34	7	100,5
DAU09016I	40	7	102,7
DAU09017E	27	5	89,3
DAU09017I	31	5	90,9
DAU09020E	31	7	99
DAU09020I	37	7	100,7
DAU09021E	28	5,5	85,5
DAU09021I	32	5,5	86,7
DAU09022E	24,7	5,5	87,16
DAU09022I	29	5,5	89,09
DAU09024E	27	5,5	96,8
DAU09024I	30	5,5	96,9
DAU09025E	29	5	81,32
DAU09025I	36	5	82,47
DAU09026E	36	7	99,1
DAU09026I	41	7	100,6
DAU09027E	26	5	92,8
DAU09027I	30	5	91,4
DAU09028E	28,9	5,45	81

4PLAY

Válvulas de admisión y escape



ESPECIFICACIONES

Tolerancia (mm)	+/-0.10	+/-0.01	+/-0.20
Referencia	Diámetro cabeza	Diámetro tija	altura total
DAU09028I	36	5,45	81,95
DAU09031E	22	5,5	93,38
DAU09031I	26	5,5	97,61
DAU09032E	28	5,46	87,8
DAU09032I	33	5,5	88,66
DAU09033E	27	5	92,55
DAU09033I	30,6	5	93,05
DAU09151E	32	6	96,2
DAU09151I	38	6	102,3
DAU09152E	20	5,6	64,8
DAU09152I	23	5	65,3
DAU09156E	34	7	100,5
DAU09156I	40	7	102,6
DAU09157E	32	7	91,7
DAU09157I	37	7	97
DAU09158E	32	6	92,7
DAU09158I	30	6	100,6
DAU09159E	27,97	4,91	73,14
DAU09159I	26,98	4,41	74,25
DAU09160I	27	4,4	75,07
DAU09163E	21,48	4,9	64,63
DAU09163I	22,99	4,9	54,04
DAU09164E	31	5,36	82
DAU09164I	35,94	5,39	83,29
DAU09166E	32,96	5,37	94,17
DAU09166I	35,93	5,41	94,28
DAU09189I	23,8	5,45	64,5
DAU09190I	37,60	5,47	95,90
DAU09190E	32,40	5,45	96,50
DAU09191I	35,97	5,95	95,75
DAU09191E	30,96	5,94	89,30
DAU09192I	30,00	5,49	118,60
DAU09192E	25,99	5,48	115,99
DAU09193I	31,00	5,95	100,99
DAU09193E	26,99	5,94	101,20
DAU09194I	35,95	5,95	101,03
DAU09194E	32,00	5,95	101,23
DAU09195I	35,00	5,97	114,65
DAU09195E	30,02	5,96	115,57
DAU09197I	34,46	5,48	95,80
DAU09197E	29,10	5,44	96,58
DXU09500E2	25	5,5	91,5
DXU09500I2	30	5,5	92
DXU09518E2	28,50	6	92,5
DXU09518I2	34	6	93,8
DXU09521E	28	5	75
DXU09521I	27	4,5	76,3
DXU09524I	27	4,7	77,2

800 RZR "4"	10-14	DAU09195I	20,30	DAU09195E	23,68
800 Sportsman EFI	08-14	DAU09195I	20,30	DAU09195E	23,68
850 Scrambler	13-15	DAU09192I	19,10	DAU09192E	21,15
850 Sportsman	09-15	DAU09192I	19,10	DAU09192E	21,15
900 Ranger	13-15	DAU09197I	20,72	DAU09197E	22,36
900 RZR XP	11-14	DAU09190I	20,30	DAU09190E	23,68
900 RZR XP "4"	12-14	DAU09190I	20,30	DAU09190E	23,68
900 RZR 50/60"	2015	DAU09197I	20,72	DAU09197E	22,36
1000 RZR XP	14-16	DAU09190I	20,30	DAU09197E	23,68
1000 RZR XP "4"	14-16	DAU09190I	20,30	DAU09197E	23,68

VÁLVULAS DE ADMISIÓN VÁLVULAS DE ESCAPE

SUZUKI	Año	Referencia	P.V.P.	Referencia	P.V.P.
LT-F 250 Ozark	02-14	DAU09032I	18,50	DAU09032E	22,05
LT-F 250 Quadrunner	89-02	DAU09032I	18,50	DAU09032E	22,05
LT-Z 250 QuadSport	04-09	DAU09032I	18,50	DAU09032E	22,05
LT-F 300 King Quad	99-02	DAU09032I	18,50	DAU09032E	22,05
LT-A 400 Eiger	02-11	DAU09033I	19,10	DAU09033E	22,00
LT-A 400 King Quad	08-14	DAU09033I	19,10	DAU09033E	22,00
LT-F 400 Eiger	02-11	DAU09033I	19,10	DAU09033E	22,00
LT-F 400 King Quad	08-14	DAU09033I	19,10	DAU09033E	22,00
LT-Z 400	03-14	DAU09025I	18,90	DAU09025E	23,75
LT-R 450	06-09	DAU09028I	22,41	DAU09028E	22,41
LT-A 450 King Quad	07-14	DAU09033I	19,10	DAU09033E	22,00
LT-A 500 King Quad	09-14	DAU09033I	19,10	DAU09033E	22,00
LT-A 500 Quadmaster	00-02	DAU09033I	19,10	DAU09033E	22,00
LT-A 500 Vinson	02-07	DAU09033I	19,10	DAU09033E	22,00
LT-F 500 Vinson	02-07	DAU09033I	19,10	DAU09033E	22,00
LT-F 500 Quadrunner	98-05	DAU09033I	19,10	DAU09033E	22,00
LT-V 700 Twin Peaks	04-05	DAU09027I	20,55	DAU09027E	22,00
LT-A 750 King Quad	08-13	DAU09166I	22,55	DAU09166E	24,55

VÁLVULAS DE ADMISIÓN VÁLVULAS DE ESCAPE

YAMAHA	Año	Referencia	P.V.P.	Referencia	P.V.P.
YFM 80 Badger	92-01	DAU09152I	18,63	DAU09152E	19,22
YFM 80 Grizzly	05-08	DAU09152I	18,63	DAU09152E	19,22
YFM 80 Raptor	02-08	DAU09152I	18,63	DAU09152E	19,22
YFM 100 Champ	87-91	DAU09152I	18,63	DAU09152E	19,22
YFM 125 Grizzly	04-13	DAU09152I	18,63	DAU09152E	19,22
YFM 125 Raptor	11-13	DAU09152I	18,63	DAU09152E	19,22
YFB 250 Timberwolf	92-00	DXU09518I2	18,58	DXU09518E2	20,29
YFM 250 Bear Tracker	99-04	DXU09518I2	18,58	DXU09518E2	20,29
YFM 250 Bruin	05-06	DXU09518I2	18,58	DXU09518E2	20,29
YFM 250 Big Bear	07-08	DXU09518I2	18,58	DXU09518E2	20,29
YFM 250 Raptor	08-14	DAU09165I		DAU09165E	
YFM 350 Bruin	04-06	DAU09156I	19,30	DAU09156E	21,74
YFM 350 Grizzly	07-14	DAU09156I	19,30	DAU09156E	21,74
YFM 350 Grizzly IRS	07-14	DAU09156I	19,30	DAU09156E	21,74
YFM 350 Raptor	04-13	DAU09156I	19,30	DAU09156E	21,74
YFM 350 Warrior	87-04	DAU09156I	19,30	DAU09156E	21,74
YFM 350 Wolverine "semi"	95-05	DAU09156I	19,30	DAU09156E	21,74
YFM 350 Wolverine	06-09	DAU09156I	19,30	DAU09156E	21,74
YFM 400 Big Bear PRO	00-06	DAU09156I	19,30	DAU09156E	21,74
YFM 400 Big Bear IRS	07-12	DAU09156I	19,30	DAU09156E	21,74
YFM 400 Grizzly IRS	2007	DAU09156I	19,30	DAU09156E	21,74
YFM 400 Kodiak "semi"	93-99	DAU09156I	19,30	DAU09156E	21,74
YFM 400 Kodiak	00-02	DAU09156I	19,30	DAU09156E	21,74
YFM 450 Grizzly	07-14	DAU09016I	24,17	DAU09016E	24,17
YFM 450 Kodiak	2003	DAU09016I	24,17	DAU09016E	24,17
YFM 450 Kodiak IRS	04-06	DAU09016I	24,17	DAU09016E	24,17
YFM 450 Wolverine	06-11	DAU09016I	24,17	DAU09016E	24,17
YFZ 450	04-11	DXU09524I DXU09521I (CENTRO)	25,40 24,61	DXU09521E	25,08
YFZ 450	12-13	DAU09160I DAU09159I (CENTRO)	21,50 21,50	DAU09159E	23,10
YFZ 450 R	09-16	DXU09524I DXU09521I (CENTRO)	25,40 24,61	DXU09521E	25,08
YFM 660 Grizzly	02-06	DAU09158I	20,55	DAU09158E	21,75
YFM 660 Raptor	01-05	DAU09158I	20,55	DAU09158E	21,75
YXR 660 Rhino	03-07	DAU09158I	20,55	DAU09158E	21,75
YFM 700 Raptor	06-16	DAU09151I	19,50	DAU09151E	23,60
YFM 700 Grizzly	07-15	DAU09151I	19,50	DAU09151E	23,60
YXR 700 Rhino	08-12	DAU09151I	19,50	DAU09151E	23,60
YXR 700 Viking	14-15	DAU09151I	19,50	DAU09151E	23,60

RUEDAS Y NEUMÁTICOS

MOTOR

ADMISIÓN / ESCAPE
REFRIGERACIÓN

ELECTRICO

SUSPENSIÓN / DIRECCIÓN

FRENOS

TRANSMISIÓN

CONTROLES Y MANDOS

CHASIS

ACCESORIOS

4PLAY Retenes de válvula

Se entregan en paquetes de 10 unidades.

P.V.P
14,90

Referencia	Ø Interior (mm)	Ø Exterior (mm)	Altura (mm)	Material	Ref. Origen
DAT09090	4,5 / 5,4	9,1	2,7	Teflón	14730-028-013
DAT09092	4,5 / 7,35	10,46	8,33	Vitón	12209-GB4-671
DAT09093	4,9 / 7,6	10,7	8,4	NBR	12209-107-760
DAT09094	5 / 7,5	10,8	7,9	Vitón	12208-413-003 12209-KL4-005
DAT09159	6,2 / 10,2				
DAT09175	5 / 8,5	10,7	8,3	NBR	92049-1062
DAT09176	6,2 / 10,1	13,6	9,3	Vitón	92049-016
DAT09177	4,5 / 8,4	11	7,8	Vitón	92049-1218
DAT09178	4,8 / 7,88	11	8,3	Vitón	09289-05003 09289-05015
DAT09180	4,3 / 7,55	10,1	8,8	Vitón	09289-05011 92049-S006
DAT09181	4,4 / 8,3	10,9	8	Vitón	2HX-12119-00
DAT09183	5,1 / 9,5				
DAT09184	6,1 / 10,2				



HONDA	Año	Ref. Original	Referencia	Descripción
TRX 90 Fourtrax	93-14	12209-GB4-671	DAT09092	VITON
TRX 200 Fourtrax	90-96	12209-KL4-005	DAT09094	VITON
TRX 250 Recon	97-01	12208-413-003	DAT09094	VITON
TRX 250 EX Sportrax	01-14	12209-KL4-005	DAT09094	VITON
TRX 250 X Fourtrax	87-92	12209-KL4-005	DAT09094	VITON
TRX 300 EX Sportrax	93-09	12209-KL4-005	DAT09094	VITON
TRX 300 Fourtrax	89-00	12209-KL4-005	DAT09094	VITON
TRX 350 Rancher	00-06	12209-KL4-005	DAT09094	VITON
TRX 400 Sportrax	99-14	12209-KL4-005	DAT09094	VITON
*TRX 400 Rancher	04-07	12209-KL4-005	DAT09094	VITON
TRX 400 Foreman	95-03	12209-KL4-005	DAT09094	VITON
TRX 450 Foreman	98-03	12209-KL4-005	DAT09094	VITON
TRX 450 R	04-14	12209-KL4-005	DAT09094	VITON
TRX 500 Rubicon	01-14	12209-KL4-005	DAT09094	VITON
TRX 650 Rincon	03-05	12209-KL4-005	DAT09094	VITON
TRX 680 Rincon	06-14	12209-KL4-005	DAT09094	VITON

KAWASAKI	Año	Ref. Original	Referencia	Descripción
KLF 220 Bayou	88-02	92049-1062	DAT09175	NBR
KLF 250 Bayou	03-11	92049-1062	DAT09175	NBR
KSF 250 Mojave	88-04	92049-1062	DAT09175	VITON
KEF 300 Lakota	95-03	92049-016	DAT09176	VITON
KLF 300 Bayou	88-04	92049-016	DAT09176	VITON
KVF 300 Prairie	99-02	92049-016	DAT09176	VITON
KVF 360 Prairie	02-13	92049-016	DAT09176	VITON
KLF 400 Bayou	93-99	92049-016	DAT09176	VITON
KFX 400	03-06	92049-S006	DAT09180	VITON
KVF 400 Prairie	98-02	92049-1062	DAT09175	VITON
KFX 450 R	10-12	92049-1062	DAT09175	NBR
KVF 650 Brute Force	05-13	92049-1218	DAT09177	VITON
KVF 650 Prairie	02-03	92049-1218	DAT09177	VITON
KFX 700 V-Force	04-09	92049-1218	DAT09177	VITON
KVF 700 Prairie	04-06	92049-1218	DAT09177	VITON
KRF 750 Terryx	08-12	92049-1218	DAT09177	VITON
KVF 750 Brute Force	06-12	92049-1218	DAT09177	VITON

SUZUKI	Año	Ref. Original	Referencia	Descripción
LT-Z 90 QuadSport	07-09	09289-05003	DAT09178	VITON
LT-F 160 Quadrunner	89-04	09289-05015	DAT09178	VITON
LT-F 250 Ozark	02-14	09289-05015	DAT09178	VITON
LT-F 250 Quadrunner	88-02	09289-05003	DAT09178	VITON
LT-Z 250 QuadSport	04-09	09289-05015	DAT09178	VITON
LT-F 300 King Quad	99-02	09289-05003	DAT09178	VITON
LT-A 400 Eiger	02-07	09289-05011	DAT09180	VITON
LT-A 400 King Quad	08-09	09289-05011	DAT09180	VITON
LT-F 400 Eiger	02-07	09289-05011	DAT09180	VITON
LT-Z 400 QuadSport	03-08	09289-05011	DAT09180	VITON
LT-A 450 King Quad	07-09	09289-05011	DAT09180	VITON
LT-R 450	06-09	09289-05015	DAT09178	VITON

LT-A 500 Quadrunner	00-01	09289-05011	DAT09180	VITON
LT-A 500 King Quad	2009	09289-05011	DAT09180	VITON
LT-A 500 Vinson	02-07	09289-05011	DAT09180	VITON
LT-F 500 Quadrunner	98-02	09289-05011	DAT09180	VITON
LT-A 700 King Quad	05-07	09289-05015	DAT09178	VITON
LT-V 700 Twin Peaks	04-05	09289-05015	DAT09178	VITON
LT-A 750 King Quad	08-11	09289-05015	DAT09178	VITON

YAMAHA	Año	Ref. Original	Referencia	Descripción
YFM 50 Raptor	04-08	2HX-12119-00	DAT09181	VITON
YFM 80 Badger	92-01	2HX-12119-00	DAT09181	VITON
YFM 80 Grizzly	05-08	2HX-12119-00	DAT09181	VITON
YFM 80 Raptor	02-08	2HX-12119-00	DAT09181	VITON
YFM 100 Champ	87-91	2HX-12119-00	DAT09181	VITON
YFM 125 Grizzly	04-13	2HX-12119-00	DAT09181	VITON
YFA1 125 Brezze	89-04	2HX-12119-00	DAT09181	VITON
YFB 250 Timberwolf	92-00	5H0-12119-00	DAT09183	VITON
YFM 250 Bear Tracker	99-04	5H0-12119-00	DAT09183	VITON
YFM 250 Big Bear	07-08	5H0-12119-00	DAT09183	VITON
YFM 250 Bruin	05-06	5H0-12119-00	DAT09183	VITON
YFM 350 Big Bear	87-99	1J7-12119-01-00	DAT09184	VITON
YFM 350 Big Bear	96-99	M01-12129-00	DAT09159	VITON
YFM 350 Bruin 2x4	04-06	M01-12129-00	DAT09159	VITON
YFM 350 Bruin 4x4	04-06	M01-12129-00	DAT09159	VITON
YFM 350 Grizzly 2x4	07-11	M01-12129-00	DAT09159	VITON
YFM 350 Grizzly 4x4	07-12	M01-12129-00	DAT09159	VITON
YFM 350 Grizzly 4x4 IRS	07-11	M01-12129-00	DAT09159	VITON
YFM 350 R	04-14	M01-12129-00	DAT09159	VITON
YFM 350 Warrior	87-04	1J7-12119-01-00	DAT09184	VITON
YFM 350 Wolverine semi.	95-05	M01-12129-00	DAT09159	VITON
YFM 400 Big Bear IRS	07-12	M01-12129-00	DAT09159	VITON
YFM 400 Big Bear PRO	07-12	M01-12129-00	DAT09159	VITON
YFM 400 Grizzly IRS	2007	M01-12129-00	DAT09159	VITON
YFM 400 Kodiak	00-06	M01-12129-00	DAT09159	VITON
YFM 400 Kodiak semi.	93-99	M01-12129-00	DAT09159	VITON
YFM 450 Kodiak	03-06	M01-12129-00	DAT09159	VITON
YFM 450 Grizzly	07-14	M01-12129-00	DAT09159	VITON
YFM 450 Wolverine	06-11	M01-12129-00	DAT09159	VITON
YXR 450 Rhino	06-09	M01-12129-00	DAT09159	VITON
YFM 600 Grizzly	98-01	1J7-12119-01-00	DAT09184	VITON
YFM 660 Grizzly	02-08	5H0-12119-00	DAT09183	VITON
YFM 660 Raptor	01-05	5H0-12119-00	DAT09183	VITON
YFM 700 Grizzly	07-14	5H0-12119-00	DAT09183	VITON
YFM 700 Raptor	06-14	5H0-12119-00	DAT09183	VITON
TT 600	1986	1J7-12119-01-00	DAT09184	VITON
XT 600	86-95	1J7-12119-01-00	DAT09184	VITON
XV 535 Virago	87-99	1J7-12119-01-00	DAT09184	VITON
SRX 600	1986	1J7-12119-01-00	DAT09184	VITON
XVS 650 V-Star	98-11	1J7-12119-01-00	DAT09184	VITON



Caja de pastillas de reglaje



Referencia	Descripción	P.V.P
DMX0943100	Diámetro 7,48mm - Grosor de 120 a 350 - 141 unidades	145,95
DMX0943300	Diámetro 8,90mm - Grosor de 172 a 260 - 69 unidades	87,95
DMX0943200	Diámetro 9,48mm - Grosor de 120 a 350 - 141 unidades	155,95

Pastillas de reglaje (bolsa con 3 unidades)

P.V.P
11,95

Set de 3 unidades
Pastilla de 7,48mm



P.V.P
11,95

Set de 3 unidades
Pastilla de 9,48mm



Referencia	Medida
DMX0943101	120
DMX0943102	125
DMX0943103	130
DMX0943104	135
DMX0943105	140
DMX0943106	145
DMX0943107	150
DMX0943108	155
DMX0943109	160
DMX0943110	165
DMX0943111	170
DMX0943112	175
DMX0943113	180
DMX0943114	185
DMX0943115	190
DMX0943116	195
DMX0943117	200
DMX0943118	205
DMX0943119	210
DMX0943120	215
DMX0943121	220
DMX0943122	225
DMX0943123	230
DMX0943124	235

Referencia	Medida
DMX0943125	240
DMX0943126	245
DMX0943127	250
DMX0943128	255
DMX0943129	260
DMX0943130	265
DMX0943131	270
DMX0943132	275
DMX0943133	280
DMX0943134	285
DMX0943135	290
DMX0943136	295
DMX0943137	300
DMX0943138	305
DMX0943139	310
DMX0943140	315
DMX0943141	320
DMX0943142	325
DMX0943143	330
DMX0943144	335
DMX0943145	340
DMX0943146	345
DMX0943147	350

Referencia	Medida
DMX0943201	120
DMX0943202	125
DMX0943203	130
DMX0943204	135
DMX0943205	140
DMX0943206	145
DMX0943207	150
DMX0943208	155
DMX0943209	160
DMX0943210	165
DMX0943211	170
DMX0943212	175
DMX0943213	180
DMX0943214	185
DMX0943215	190
DMX0943216	195
DMX0943217	200
DMX0943218	205
DMX0943219	210
DMX0943220	215
DMX0943221	220
DMX0943222	225
DMX0943223	230
DMX0943224	235

Referencia	Medida
DMX0943225	240
DMX0943226	245
DMX0943227	250
DMX0943228	255
DMX0943229	260
DMX0943230	265
DMX0943231	270
DMX0943232	275
DMX0943233	280
DMX0943234	285
DMX0943235	290
DMX0943236	295
DMX0943237	300
DMX0943238	305
DMX0943239	310
DMX0943240	315
DMX0943241	320
DMX0943242	325
DMX0943243	330
DMX0943244	335
DMX0943245	340
DMX0943246	345
DMX0943247	350

P.V.P
11,95

Set de 3 unidades
Pastilla de 8,90mm

Referencia	Medida
DMX0943301	172
DMX0943302	176
DMX0943303	180
DMX0943304	184
DMX0943305	188
DMX0943306	192
DMX0943307	196
DMX0943308	200

Referencia	Medida
DMX0943309	204
DMX0943310	208
DMX0943311	212
DMX0943312	216
DMX0943313	220
DMX0943314	224
DMX0943315	228
DMX0943316	232

Referencia	Medida
DMX0943317	236
DMX0943318	240
DMX0943319	244
DMX0943320	248
DMX0943321	252
DMX0943322	256
DMX0943323	260

Bielas completas

Bielas completas con bulón de cigüeñal, separadores y rodamientos.



		BIELA							BULÓN	RODAMIENTO PISTÓN	RODAMIENTO BIELA	ARANDELA	
ARTIC CAT	Año	Referencia	P.V.P	A	B	C	D	E	Ø	Largo	Medidas	Medidas	Medidas
DVX 400	04-08	DAT09165	105,96	107	20	43	20	22	35	61,85	35x43x21.75		
		BIELA							BULÓN	RODAMIENTO PISTÓN	RODAMIENTO BIELA	ARANDELA	
HONDA	Año	Referencia	P.V.P	A	B	C	D	E	Ø	Largo	Medidas	Medidas	Medidas
TRX 250 EX Sportrax	01-08	DAT09196	106,39	105,5	15	38	18	18	30	54	30x38x17.8	35x45x1,0	35X45X1.0
TRX 250 Recon	97-13	DAT09196	106,39	105,5	15	38	18	18	30	54	30x38x17.8	35x45x1,0	35X45X1.0
TRX 300 EX Sportrax	93-09	DAT09453	58,04	122	17	41	20	20	33	59,8	33x40.7x19.75	33,2x50,9x1,0	33.2 X 50.9 X 1.0
TRX 300 FW	88-00	DAT09453	58,04	122	17	41	20	20	33	59,8	33x40.7x19.75	33,2x50,9x1,0	33.2 X 50.9 X 1.0
TRX 350 Rancher	00-06	DAT09172	70,47	116	20	41	20	17	33	60		33x51x1,0	33 X 51X 1.0
TRX 400 EX Sportrax	99-09	DAT09250	100,00	122,6	20	43	17	21	34	66	34x43x20		
TRX 400 Foteman	95-03	DAT09212	61,98	122,4	19	41	20	20	33	62,9	33x41x19.5	33,1x50,94x1,0	33.1 X 50.94 X 1.0
TRX 450 Foreman	98-04	DAT09212	61,98	122,4	19	41	20	20	33	62,9	33x41x19.5	33,1x50,94x1,0	33.1 X 50.94 X 1.0
TRX 450 R	04-05	DAT09194	131,24	111,5	21	46	19	23,5	35	62,9		35x54,8x1	35 X 54.8 X 1
TRX 450 R	06-12	DAT09193	131,24	105,5	19	42	18	20	34	65		34,2x52,9x2	34.2 X 52.9 X 2
		BIELA							BULÓN	RODAMIENTO PISTÓN	RODAMIENTO BIELA	ARANDELA	
KAWASAKI	Año	Referencia	P.V.P	A	B	C	D	E	Ø	Largo	Medidas	Medidas	Medidas
KLF 300 Bayou	86-05	DAT09164	76,54	117	18	43	18	22,6	32	58,1	32x42.85x22.3	32,2x51,7x1,2	32,2x51,7x1,2
KEF 300 Lakota	95-03	DAT09164	76,54	117	18	43	18	22,6	32	58,1	32x42.85x22.3	32,2x51,7x1,2	32,2x51,7x1,2
KVF 300 Prairie	99-02	DAT09164	76,54	117	18	43	18	22,6	32	58,1	32x42.85x22.3	32,2x51,7x1,2	32,2x51,7x1,2
KFX 400	03-06	DAT09165	105,96	107	20	43	20	22	35	61,85	35x43x21.75		
		BIELA							BULÓN	RODAMIENTO PISTÓN	RODAMIENTO BIELA	ARANDELA	
POLARIS	Año	Referencia	P.V.P	A	B	C	D	E	Ø	Largo	Medidas	Medidas	Medidas
250 Trail Blazer	90-06	DAT09166	79,40	120	23	33	18	18	25	56	25x32.75x17.6	25x42x0,8	25x42x0,8
250 Trail Boss	87-99	DAT09166	79,40	120	23	33	18	18	25	56	25x32.75x17.6	25x42x0,8	25x42x0,8
250 Xplorer	00-01	DAT09166	79,40	120	23	33	18	18	25	56	25x32.75x17.6	25x42x0,8	25x42x0,8
300	94-95	DAT09166	79,40	120	23	33	18	18	25	56	25x32.75x17.6	25x42x0,8	25x42x0,8
300 Xplorer	96-99	DAT09166	79,40	120	23	33	18	18	25	56	25x32.75x17.6	25x42x0,8	25x42x0,8
300 Xpress	96-99	DAT09166	79,40	120	23	33	18	18	25	56	25x32.75x17.6	25x42x0,8	25x42x0,8
335 Sportsman	99-00	DAT09167	86,54	130	23	43	22	22	34	71	34x42.8x21.6	34,15x51,7x1	34,15x51,7x1
350 Sportsman	1993	DAT09169	67,12	130	23	34	20	20	26	61	27x33.8x19.7	26,2x44x1	26,2x44x1
350 Trail Boss	90-93	DAT09169	67,12	130	23	34	20	20	26	61	27x33.8x19.7	26,2x44x1	26,2x44x1
400 Hawkeye	11-13	DAT09191	116,28	127,5	23	43	22	22	34	71			
400 L	94-95	DAT09169	67,12	130	23	34	20	20	26	61	27x33.8x19.7	26,2x44x1	26,2x44x1
400 Ranger	10-13	DAT09191	116,28	127,5	23	43	22	22	34	71			
400 Scrambler	2000	DAT09169	67,12	130	23	34	20	20	26	61	27x33.8x19.7	26,2x44x1	26,2x44x1
400 Sportsman	94-97	DAT09169	67,12	130	23	34	20	20	26	61	27x33.8x19.7	26,2x44x1	26,2x44x1
400 Sportsman	2001	DAT09167	86,54	130	23	43	22	22	34	71	34x42.8x21.6	34,15x51,7x1	34,15x51,7x1
400 Sportsman HO	08-13	DAT09191	116,28	127,5	23	43	22	22	34	71			
400 Sport	94-99	DAT09169	67,12	130	23	34	20	20	26	61	27x33.8x19.7	26,2x44x1	26,2x44x1
400 Trail Boss	94-95	DAT09169	67,12	130	23	34	20	20	26	61	27x33.8x19.7	26,2x44x1	26,2x44x1
400 Xplorer	95-01	DAT09169	67,12	130	23	34	20	20	26	61	27x33.8x19.7	26,2x44x1	26,2x44x1
400 Xpress	95-01	DAT09169	67,12	130	23	34	20	20	26	61	27x33.8x19.7	26,2x44x1	26,2x44x1
425 Magnum	95-98	DAT09167	86,54	130	23	43	22	22	34	71	34x42.8x21.6	34,15x51,7x1	34,15x51,7x1
450 Sportsman	06-07	DAT09191	116,28	127,5	23	43	22	22	34	71			
500 ATP	04-05	DAT09191	116,28	127,5	23	43	22	22	34	71			
500 Magnum	99-00	DAT09168	82,90	127,5	23	43	22	22			36.15x42.8x21.6		
500 Rancher	98-00	DAT09168	82,90	127,5	23	43	22	22			36.15x42.8x21.6		
500 Ranger EFI	06-07	DAT09191	116,28	127,5	23	43	22	22	34	71			
500 Scrambler	97-12	DAT09168	82,90	127,5	23	43	22	22			36.15x42.8x21.6		
500 Sportsman	96-00	DAT09168	82,90	127,5	23	43	22	22			36.15x42.8x21.6		
500 Sportsman	01-13	DAT09191	116,28	127,5	23	43	22	22	34	71			
500 Worker	2001	DAT09191	116,28	127,5	23	43	22	22	34	71			
500 Xplorer	1997	DAT09168	82,90	127,5	23	43	22	22			36.15x42.8x21.6		
700 Ranger	06-09	DAT09406	59,83	132	20	42	24	24			39x19x1.5		
700 Sportsman	02-10	DAT09406	59,83	132	20	42	24	24			39x19x1.5		
800 Ranger	08-12	DAT09408	62,12	135	18	39	18	24.2			39x19x1.5		
800 Sportsman	05-12	DAT09408	62,12	135	18	39	18	24.2			39x19x1.5		

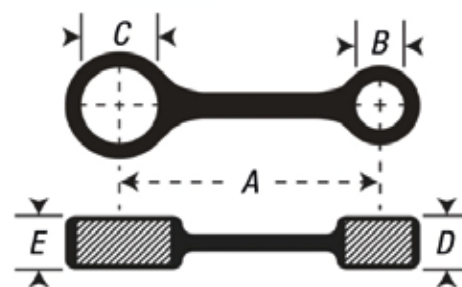

BIELA				BULÓN	RODAMIENTO PISTÓN	RODAMIENTO BIELA	ARANDELA						
SUZUKI	Año	Referencia	P.V.P.	A	B	C	D	E	Ø	Largo	Medidas	Medidas	Medidas
LT-F 250 Ozark	02-09	DAT09171	58,04	115,5	16	39	14	18	30	53	30x38.8x17.7		24,3x38x1,5
LT-F 250 Quad Runner	88-02	DAT09171	58,04	115,5	16	39	14	18	30	53	30x38.8x17.7		
LT-Z 400	03-12	DAT09165	105,96	107	20	43	20	22	35	61,85	35x43x21.75		
LT-R 450	06-09	DAT09190	96,82	107	19	42	19	22	34	61			
LT-A 400 Eiger	02-07	DAT09197	126,66	105,5	20	38	22	18	34	59,75	36x43x21.7	34x52x1,0	34x52x1
LT-A 400 King Quad	08-13	DAT09197	126,66	105,5	20	38	22	18	34	59,75	36x43x21.7	34x52x1,0	34x52x1
LT-A 500 King Quad	07-14	DAT09251	132,52										

BIELA				BULÓN	RODAMIENTO PISTÓN	RODAMIENTO BIELA	ARANDELA						
YAMAHA	Año	Referencia	P.V.P.	A	B	C	D	E	Ø	Largo	Medidas	Medidas	Medidas
YFS 200 Blaster	88-07	DAT97307	96,02	110	21	29	18	17	22	56,6	22x28.9x16.8	22,3x36,5x1,0	22,3x36,5x1
YFZ 350 Banshee	87-06	DAT97306	79,56	110	21	29	18	17	22	52,9	22x28.9x16.8	22,2x36,6x1,0	22,2x36,6x1
YFZ 350 Banshee "biela 5mm más larga"	87-06	DAT09134	89,25	115	21	29	18	17	22	52,7	22x28.9x16.8	22,2x36,9x1,0	22,2x36,9x1
YFM 350 Warrior	87-04	DAT09173	64,12	112,5	19	41	20	20	33	58	34x40.8x19.9		
YFM 350U Big Bear	96-99	DAT09173	64,12	112,5	19	41	20	20	33	58	34x40.8x19.9		
YFM 350 Wolverine	95-05	DAT09173	64,12	112,5	19	41	20	20	33	58	34x40.8x19.9		
YFM 350 Raptor	04-12	DAT09173	64,12	112,5	19	41	20	20	33	28	34x40.8x19.9		
YFM 600 Raptor	2001	DAT09174	106,81	136,5	22	45	22	22	37	73,8			
YFM 600 Raptor	02-05	DAT091742	106,81	136,5	22	45	22	22	37	73,8			
YFM 660 Grizzly	02-08	DAT091742	106,81	136,5	22	45	22	22	37	73,8			
YXR 660 Rhino	04-07	DAT091742	106,81	136,5	22	45	22	22	37	73,8			

4PLAY Cigüeñal completo

YAMAHA	Referencia	Descripción	P.V.P.
YFZ 350 Banshee	DAT09400	Cigüeñal reforzado	390,00



4PLAY Retenes motor

HONDA	Año	Referencia	P.V.P.
TRX 400 EX Sportrax	99-09	DAT09606	10,36
YAMAHA	Año	Referencia	P.V.P.
YFS 200 Blaster	88-07	DAT09641	17,08
YFZ 350 Banshee	87-06	DAT09223	13,86
YFM 350 Warrior	87-04	DAT09643	12,67
YFM 350 Raptor	04-14	DAT09643	12,67
YFM 660 Raptor	01-05	DAT09645	9,80



4PLAY Kit discos de embrague

El Kit de Embrague reforzado consta de los discos de fricción más los discos metálicos o de separación y los muelles. La calidad es superior a los discos originales, en algunos casos puede ser como mínimo igual al original.



** Kit sin muelles

4PLAY

4PLAY

NAMORA

		KIT COMPLETO		PLACAS FRICCIÓN		JUNTA EMBRAGUE	
ARTIC CAT	Año	Referencia	P.V.P.	Referencia	P.V.P.	Referencia	P.V.P.
DVX 400	04-06	DAT03915H	65,37			NA30002CG	12,73
DVX 400	07-08	DAT03652H	71,49			NA30002CG	12,73

		KIT COMPLETO		PLACAS FRICCIÓN		JUNTA EMBRAGUE	
HONDA	Año	Referencia	P.V.P.	Referencia	P.V.P.	Referencia	P.V.P.
TRX 250 R Fourtrax	89-92	DAT03903H	39,12				
TRX 250 EX Sportrax	01-14	DAT03651H	28,78				
TRX 250 Recon	97-14	DAT03651H	28,78				
TRX 300 EX Sportrax	93-14	DAT03903H	39,12			NA10002CG	7,11
TRX 400 EX Sportrax "kit Emgo"	99-14	E8859203	33,65			NA10003CG	11,41
TRX 400 EX Sportrax	99-14	DAT03900H	51,48			NA10003CG	11,41
TRX 450 R Sportrax	04-14	DAT03918H	63,45				

		KIT COMPLETO		PLACAS FRICCIÓN		JUNTA EMBRAGUE	
KAWASAKI	Año	Referencia	P.V.P.	Referencia	P.V.P.	Referencia	P.V.P.
KFX 400	03-04	DAT03915H	65,37	DMC03883C	32,52	NA30002CG	12,73
KFX 400	05-06	DAT03652H	71,49	DAT03434C	32,64	NA30002CG	12,73
KFX 450 R	08-14	DAT03658H	71,52				

		KIT COMPLETO		PLACAS FRICCIÓN		JUNTA EMBRAGUE	
KTM	Año	Referencia	P.V.P.	Referencia	P.V.P.	Referencia	P.V.P.
400 SX	09-12	DMX03209H	73,14				
450 XC	08-12	DMX03208H	94,30				
505 SX	09-12	DMX03209H	73,14				
525 XC	08-12	DMX03208H	94,30				

		KIT COMPLETO		PLACAS FRICCIÓN		JUNTA EMBRAGUE	
POLARIS	Año	Referencia	P.V.P.	Referencia	P.V.P.	Referencia	P.V.P.
PREDATOR 500	03-07	DAT03917H	65,46				

		KIT COMPLETO		PLACAS FRICCIÓN		JUNTA EMBRAGUE	
SUZUKI	Año	Referencia	P.V.P.	Referencia	P.V.P.	Referencia	P.V.P.
LT-Z 250 QuadSport	04-11	DAT03672H	41,60				
LT-F 250 Ozark	2003	DAT03671H	45,28				
LT-F 250 Ozark	2004	DAT03672H	41,60				
LT-F 250 Ozark	05-14	DAT03671H	45,28				
LTZ 400	03-04	DAT03915H	65,37	DMC03883C	32,52	NA30002CG	12,73
LTZ 400	05-14	DAT03652H	71,49	DAT03434C	32,64	NA30002CG	12,73
LT-F 400 Eiger 4x4	02-07	DAT03684H	58,39				
LT-F 400 King Quad	08-11	DAT03684H	58,39				
LT-R 450	06-11	DAT03653H	74,45			NA30005CG	9,7

		KIT COMPLETO		PLACAS FRICCIÓN		JUNTA EMBRAGUE	
YAMAHA	Año	Referencia	P.V.P.	Referencia	P.V.P.	Referencia	P.V.P.
YFS 200 Blaster	88-06	DAT03901H	38,41	DMC05807C	21,84	NA40002CG	9,83
YFM 250 Timberwolf	89-98	DAT05214**	24,66				
YFM 250 Bear Tracker	99-03	DAT05214**	24,66				
YFM 250 Bruin	04-06	DAT05214**	24,66				
YFM 250 Big Bear	07-08	DAT05214**	24,66				
YFM 250 Raptor	08-13	DAT03656H	45,78				
YFZ 350 Banshee	87-06	DAT03902H	51,22			NA40001CG	13,52
YFM 350 X Warrior "kit Emgo"	87-04			E8816753**	36,06	NA40005CG	16,8
YFM 350 X Warrior	87-04	DAT03905H	53,54			NA40005CG	16,8
YFM 350 Raptor "kit Emgo"	04-13			E8816753**	36,06	NA40005CG	16,8
YFM 350 Raptor	04-13	DAT03905H	53,54			NA40005CG	16,8
YFZ 450	04-05	DAT05217H	74,34			NA40009CG	9,83
YFZ 450	06-11	DAT03662H	66,59			NA40009CG	9,83
YFM 660 Raptor	01-05	DAT03904H	55,30			NA40004CG	13,58
YFM 700 Raptor	06-15	DAT03916H	68,34			NA40012CG	12,2



Filtros de aceite



ARTIC CAT	Año	Referencia	Hifo filtro
250	99-05	DAT07001	HF132
300	98-05	DAT07001	HF132
366	08-11	DAT07184	HF621
400	98-08	E10-55660	HF138
400	09-15	DAT07184	HF621
400 DVX	04-08	E10-55510	HF139
454	96-98	E10-55660	HF138
500	98-08	E10-55660	HF138
500	08-15	DAT07184	HF621
500 Prowler	2015	DAT07184	HF621
550	09-15	DAT07184	HF621
550 Prowler	10-13	DAT07184	HF621
600	2004	E10-82240	HF204
650 V-2	04-06	E10-82240	HF204
650 H1	06-11	DAT07184	HF621
650 Prowler	06-09	DAT07184	HF621
700	06-07	E10-55660	HF138
700	08-15	DAT07184	HF621
700 Prowler	09-15	DAT07184	HF621
1000	08-15	DAT07184	HF621
1000 Prowler	09-13	DAT07184	HF621
1000 Wildcat	13-15	DAT07184	HF621
CAN AM	Año	Referencia	Hifo filtro
Rally 175	03-07	DAT07059	
Outlander 330	04-06	E10-26966	HF152
Outlander 400	03-14	E10-26966	HF152
Outlander 450	15-16	E10-26966	HF152
Outlander 500	07-15	E10-26966	HF152
Outlander 570	2016	E10-26966	HF152
Renegade 500	08-15	E10-26966	HF152
Renegade 570	2016	E10-26966	HF152
Traxter 500	00-05	DAT07180	HF557
DS 650	00-07	DMC07200	HF151
Outlander 650	07-15	E10-26966	HF152
Outlander 800	06-15	E10-26966	HF152
Renegade 800	07-15	E10-26966	HF152
Commander 800	11-15	E10-26966	HF152
Outlander 1000	11-16	E10-26966	HF152
Renegade 1000	12-16	E10-26966	HF152
Commander 1000	11-16	E10-26966	HF152
Maverick 1000	14-16	E10-26966	HF152
GAS GAS	Año	Referencia	Hifo filtro
450 Wild HP	03-07	E10-99200	HF112

Tipo	Equivalencia Hifo Filtro	Ref. EMGO	Ref. BRONCO	P.V.P
A	HF112	E10-99200		2,58
A	HF113		DAT070052	2,58
A	HF116		DAT07066	3,24
A	HF123	E10-30000		2,58
A	HF132	E10-55500		2,58
C	HF138	E10-55660		5,52
A	HF139	E10-55510		2,58
A	HF141	E10-79130		2,58
A	HF142	E10-79120		2,58
A	HF143	E10-79110		2,58
A	HF145	E10-79100		2,58
C	HF147	E10-82250		5,52
A	HF151		DMC07200	2,58
A	HF152	E10-26966		2,58
A	HF155		DMX07010	3,57
A	HF157		DMX07013	3,64
C	HF198		DAT070631	5,52
C	HF199		DAT07087	5,52
C	HF204	E10-82240		5,52
C	HF303	E10-82230		5,52
C	HF557		DAT07180	5,52
C	HF621		DAT07184	5,52
A	HF111		DAT070131	3,48

HONDA	Año	Referencia	Hifo filtro
TRX 250 EX Sportrax	01-11	E10-99200	HF112
TRX 250 Recon	97-12	E10-99200	HF112
TRX 300 FW	89-01	E10-99200	HF112
TRX 300 EX Sportrax	93-08	E10-99200	HF112
TRX 350 Rancher	00-06	DAT070052	HF113
TRX 400 Sportrax	99-08	DAT070052	HF113
TRX 400 Sportrax	09-13	E10-99200	HF112
TRX 400 Foreman / Rancher	95-02	DAT070052	HF113
TRX 420 Rancher	07-16	DAT070052	HF113
TRX 450 Foreman	98-04	DAT070052	HF113
TRX 450 R	04-14	DAT070131	HF111
TRX 500 Rubicon	05-15	DAT070131	HF111
TRX 650 Rincon	03-05	DAT070131	HF111
TRX 680 Rincon	06-15	DAT070131	HF111
TRX 700 XX	08-11	E10-99200	HF112

KAWASAKI	Año	Referencia	Hifo filtro
KLF 220 Bayou	88-02	E10-30000	HF123
KLF 250 Bayou	03-11	E10-30000	HF123
KSF 250 Mojave	88-04	E10-30000	HF123
KEF 300 Lakota	95-03	E10-30000	HF123
KLF 300 Bayou	88-04	E10-30000	HF123
KVF 360 Prairie	03-14	E10-82240	HF204
KFX 400	03-06	E10-55510	HF139
KLF 400 Bayou	93-98	E10-82230	HF303
KVF 400 Prairie	98-02	E10-82230	HF303
KFX 450 R	08-14	E10-99200	HF112
KVF 650 Brute Force	05-13	E10-82240	HF204
KVF 650i Brute Force	06-14	E10-82240	HF204
KVF 650 Prairie	02-03	E10-82240	HF204
KFX 700 V-Force	04-09	E10-82240	HF204
KVF 700 Prairie	04-06	E10-82240	HF204
KVF 750i Brute Force	05-16	E10-82240	HF204
KRF 750 Teryx	08-13	E10-82240	HF204
KRF 800 Teryx	14-16	E10-82240	HF204

KYMCO	Año	Referencia	Hifo filtro
375 Maxxer	08-12	E10-55660	HF138
375 MXU	08-12	E10-55660	HF138
400 MXU	08-12	E10-55660	HF138
450 Maxxer	11-12	E10-55660	HF138
450 MXU	11-12	E10-55660	HF138
500 MXU	06-12	E10-82250	HF147
550 MXU	11-12	E10-82250	HF147
700 MXU	2013	E10-82250	HF147

RUEDAS Y NEUMÁTICOS

MOTOR

ADMISIÓN / ESCAPE
REFRIGERACIÓN

ELECTRICO

SUSPENSIÓN / DIRECCIÓN

FRENOS

TRANSMISIÓN

CONTROLES Y MANDOS

CHASIS

ACCESORIOS



Filtros de aceite

KTM - POLARIS

** DMX07010	Largo
*DMX07013	Corto



KTM	Año	Referencia	Hifo filtro
450 XC	08-11	DMX07010 ** DMX07013*	HF155 HF157
525 XC	06-11	DMX07010 ** DMX07013*	HF155 HF157

POLARIS	Año	Referencia	Hifo filtro
200 Phoenix	05-12	DAT07073	
300 Hawkeye	07-11	E10-82230	HF303
300 Sawtooth	05-13	DAT07073	
300 Sportsman	08-10	E10-82230	HF303
300 Xplorer	96-99	E10-82230	HF303
300 Xpress	96-99	E10-82230	HF303
325 Magnum	00-02	E10-82230	HF303
325 Sportsman ACE	14-16	DAT07066	HF116
325 Sportsman	2015	DAT07066	HF116
325 Trail Boss	00-02	E10-82230	HF303
325 Xpedition	00-02	E10-82230	HF303
330 Hawkeye	01-06	E10-82230	HF303
330 Magnum	01-06	E10-82230	HF303
330 Trail Blazer	08-13	E10-82230	HF303
330 Trail Boss	03-11	E10-82230	HF303
335 Sportsman	99-01	E10-82230	HF303
335 Worker	04-08	E10-82230	HF303
400 Hawkeye	12-14	DAT07087	HF199
400 Scrambler	95-02	E10-82230	HF303
400 Sport L	94-99	E10-82230	HF303
400 Sportsman	01-11	E10-82230	HF303
400 Sportsman	12-14	DAT07087	HF199
400 Trail Blazer	2003	E10-82230	HF303
400 Xplorer	95-02	E10-82230	HF303
400 Xpress	1996	E10-82230	HF303
425 Xpedition	00-02	E10-82230	HF303
450 Outlaw	08-09	DMX07010 ** DMX07013*	HF155 HF157
450 Sportsman	06-07	E10-82230	HF303
500 Magnum	99-03	E10-82230	HF303
500 Outlaw	06-07	E10-99200	HF112
500 Predator	03-07	E10-99200	HF112
500 Ranger	06-13	E10-82230	HF303
500 Scrambler	96-11	E10-82230	HF303
500 Scrambler	2012	DAT07088	
500 Sportsman	00-11	E10-82230	HF303
500 Sportsman	12-14	DAT07087	HF199
500 Worker	99-01	E10-82230	HF303
500 Xplorer	04-06	E10-82230	HF303
525 Outlaw	07-11	DMX07010 ** DMX07013*	HF155 HF157
550 Sportsman	09-14	DAT07087	HF199
570 Sportsman	14-15	DAT07087	HF199
570 RZR	12-14	DAT07062	HF198
600 Sportsman	03-05	DAT070631	HF198
700 Ranger	06-09	DAT07062	HF198
700 Sportsman	04-08	DAT07062	HF198
800 Ranger	08-14	DAT070631	HF198
800 RZR	08-14	DAT07062	HF198
RZR 800 "S"	09-14	DAT07062	HF198
RZR 800 4	10-13	DAT07062	HF198
800 Sportsman	05-14	DAT07062	HF198
850 Sportsman	09-14	DAT07087	HF199
900 Ranger	2013	DAT07087	HF199
900 RZR XP	11-16	DAT07087	HF199
900 RZR XP 4	11-12	DAT07087	HF199
1000 RZR	2014	DAT07062	HF198
1000 RZR	15-16	DAT07087	HF199
1000 Scrambler	14-15	DAT07087	HF199
1000 Sportsman	15-16	DAT07087	HF199

SUZUKI	Año	Referencia	Hifo filtro
LTF 160 Quadrunner	89-04	DAT07001	HF132
LT 230 Quadrunner	87-93	DAT07001	HF132
LT 250 Quadrunner	89-90	DAT07001	HF132
LT-F 250 Ozark	02-14	DAT07001	HF132
LT-F 250 Quadrunner	89-02	DAT07001	HF132
LT-Z 250 Quadrunner	04-09	DAT07001	HF132
LT 300 Quadrunner	87-89	DAT07001	HF132
LT-F 300 King Quad	99-02	DAT07001	HF132
LT-A 400 Eiger	02-07	E10-55660	HF138
LT-A 400 King Quad	09-14	E10-55660	HF138
LT-F 400 Eiger	02-07	E10-55660	HF138
LT-F 400 King Quad	08-12	E10-55660	HF138
LT-Z 400 Quadrunner	03-14	E10-55510	HF139
LT-A 450i King Quad	07-09	E10-55660	HF138
LT-R 450	06-09	E10-55510	HF139
LT-A 500 King Quad	09-15	E10-55660	HF138
LT-A 500 Quadrunner	00-01	E10-55660	HF138
LT-A 500 Vinson	02-07	E10-55660	HF138
LT-F 500 Vinson	02-06	E10-55660	HF138
LT-F 500 Quadrunner	98-02	E10-55660	HF138
LT-A 700 King Quad	05-08	E10-55660	HF138
LT-V 700 Twin Peaks	04-05	E10-82240	HF204
LT-A 750i King Quad	08-14	E10-55660	HF138

YAMAHA	Año	Referencia	Hifo filtro
YFM 250 Bear Tracker	99-04	E10-79110	HF143
YFM 250 Big Bear	07-09	E10-79110	HF143
YFM 250 Bruin	05-06	E10-79110	HF143
YFM 250 Raptor	08-13	E10-79130	HF141
YFB 250 Timberwolf	92-00	E10-79120	HF142
YFM 350 Big Bear	87-99	E10-79120	HF142
YFM 350 Bruin	04-06	E10-82230	HF303
YFM 350 Grizzly	07-16	E10-82230	HF303
YFM 350 Grizzly IRS	07-11	E10-82230	HF303
YFM 350 Raptor	04-13	E10-79120	HF142
YFM 350 Warrior	87-04	E10-79120	HF142
YFM 350 Wolverine semi.	95-05	E10-79120	HF142
YFM 350 Wolverine	06-09	E10-82230	HF303
YFM 400 Big Bear PRO	00-06	E10-79120	HF142
YFM 400 Big Bear IRS	07-12	E10-79120	HF142
YFM 400 Grizzly IRS	2007	E10-82240	HF204
YFM 400 Kodiak auto.	00-06	E10-82230	HF303
YFM 400 Kodiak semi.	93-99	E10-79120	HF142
YFM 450 Grizzly	07-16	E10-82230	HF303
YFM 450 Kodiak	04-06	E10-82230	HF303
YXR 450 Rhino	06-09	E10-82230	HF303
YFM 450 Wolverine	06-11	E10-82230	HF303
YFZ 450	04-13	E10-79130	HF141
YFZ 450 R	09-16	E10-79130	HF141
YFM 550 Grizzly	09-14	E10-82240	HF204
YFM 600 Grizzly	98-01	DAT07012	HF145
YFM 660 Grizzly	02-08	E10-82230	HF303
YFM 660 Raptor	01-05	E10-82250	HF147
YXR 660 Rhino	03-07	E10-82230	HF303
YFM 700 Grizzly	07-16	E10-82240	HF204
YFM 700 Kodiak	07-16	E10-82240	HF204
YFM 700 Raptor	06-16	E10-79100	HF145
YXE Wolverine	2016	E10-82240	HF204
YXR 700 Rhino	08-13	E10-82240	HF204
YXM 700 Viking	14-16	E10-82240	HF204
YXZ 1000	2016	E10-82240	HF204

ADMISIÓN / ESCAPE ***REFRIGERACIÓN***

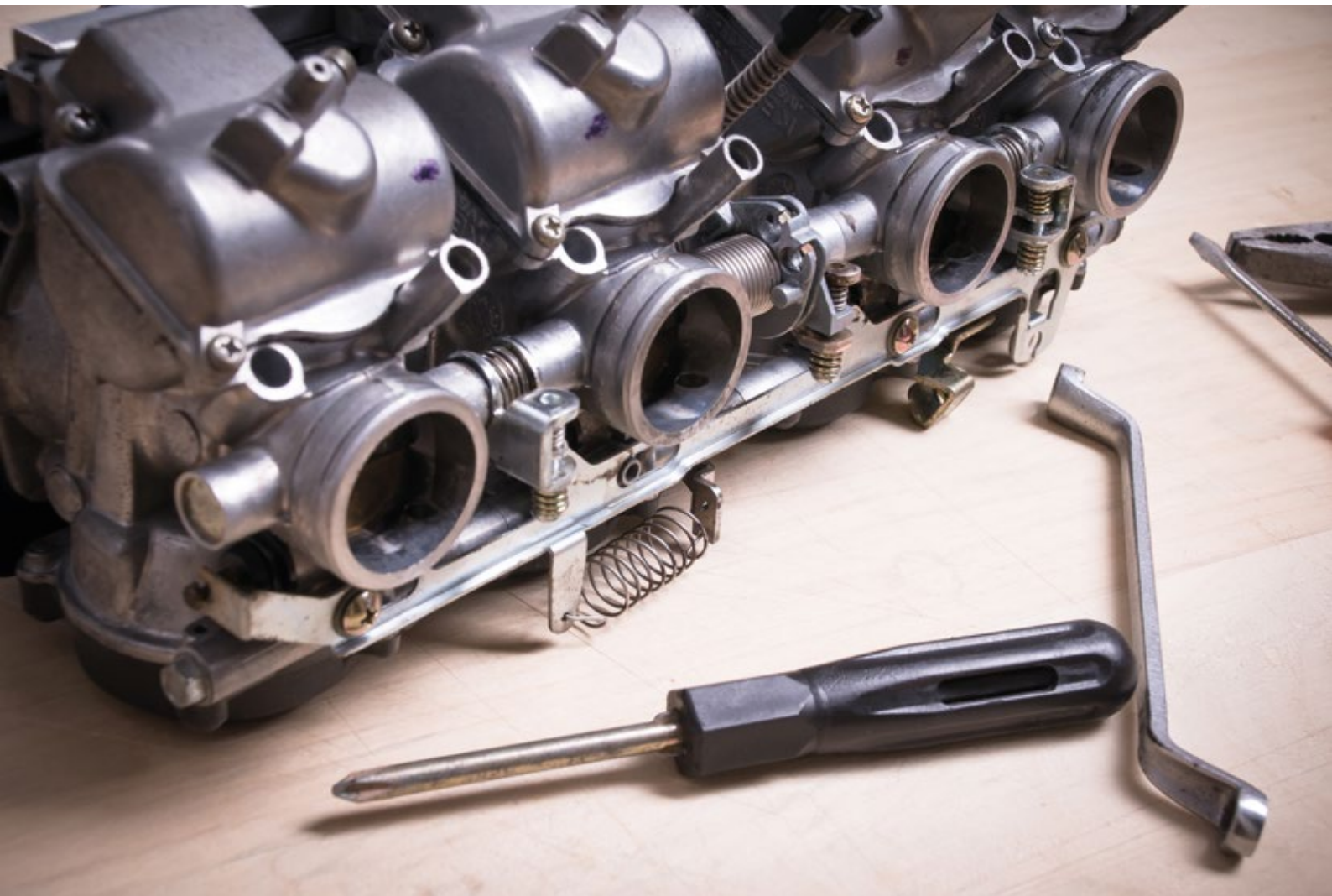

ADMISIÓN / ESCAPE / REFRIGERACIÓN



Chiclés carburador

P.V.P
5

Modelo Mikuni SJ

Referencia	Medida	Referencia	Medida	Referencia	Medida	Referencia	Medida
DSJ0725	72,5	DSJ0975	97,5	DSJ1225	122,5	DSJ1475	147,5
DSJ0750	75	DSJ1000	100	DSJ1250	125	DSJ1500	150
DSJ0775	77,5	DSJ1025	102,5	DSJ1275	127,5	DSJ1525	152,5
DSJ0800	80	DSJ1050	105	DSJ1300	130	DSJ1550	155
DSJ0825	82,5	DSJ1075	107,5	DSJ1325	132,5	DSJ1575	157,5
DSJ0850	85	DSJ1100	110	DSJ1350	135	DSJ1600	160
DSJ0875	87,5	DSJ1125	112,5	DSJ1375	137,5	DSJ1700	170
DSJ0900	90	DSJ1150	115	DSJ1400	140		
DSJ0925	92,5	DSJ1175	117,5	DSJ1425	142,5		
DSJ0950	95	DSJ1200	120	DSJ1450	145		

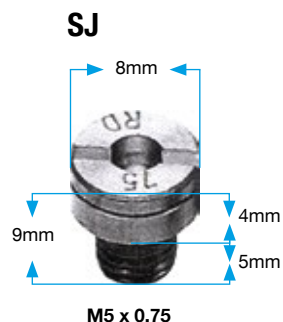

Modelo Mikuni HJ

Referencia	Medida	Referencia	Medida	Referencia	Medida	Referencia	Medida
DHJ0700	70	DHJ1750	175	DHJ3300	330	DHJ5100	510
DHJ0800	80	DHJ1800	180	DHJ3400	340	DHJ5200	520
DHJ0900	90	DHJ1850	185	DHJ3500	350	DHJ5300	530
DHJ1000	100	DHJ1900	190	DHJ3600	360	DHJ5400	540
DHJ1050	105	DHJ1950	195	DHJ3700	370	DHJ5500	550
DHJ1100	110	DHJ2000	200	DHJ3800	380	DHJ5600	560
DHJ1150	115	DHJ2100	210	DHJ3900	390	DHJ5700	570
DHJ1200	120	DHJ2200	220	DHJ4000	400	DHJ5800	580
DHJ1250	125	DHJ2300	230	DHJ4100	410	DHJ5900	590
DHJ1300	130	DHJ2400	240	DHJ4200	420	DHJ6000	600
DHJ1350	135	DHJ2500	250	DHJ4300	430	DHJ6100	610
DHJ1400	140	DHJ2600	260	DHJ4400	440	DHJ6200	620
DHJ1450	145	DHJ2700	270	DHJ4500	450	DHJ6300	630
DHJ1500	150	DHJ2800	280	DHJ4600	460	DHJ6400	640
DHJ1550	155	DHJ2900	290	DHJ4700	470	DHJ6500	650
DHJ1600	160	DHJ3000	300	DHJ4800	480	DHJ6600	660
DHJ1650	165	DHJ3100	310	DHJ4900	490	DHJ6700	670
DHJ1700	170	DHJ3200	320	DHJ5000	500	DHJ6800	680

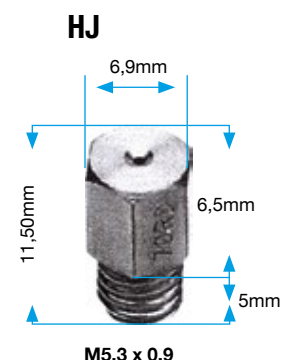

Modelo Keihin KJ

Referencia	Medida	Referencia	Medida	Referencia	Medida	Referencia	Medida
DKJ0725	72,5	DKJ0975	97,5	DKJ1225	122,5	DKJ1475	147,5
DKJ0750	75	DKJ1000	100	DKJ1250	125	DKJ1500	150
DKJ0775	77,5	DKJ1025	102,5	DKJ1275	127,5	DKJ1525	152,5
DKJ0800	80	DKJ1050	105	DKJ1300	130	DKJ1550	155
DKJ0825	82,5	DKJ1075	107,5	DKJ1325	132,5	DKJ1575	157,5
DKJ0850	85	DKJ1100	110	DKJ1350	135	DKJ1600	160
DKJ0875	87,5	DKJ1125	112,5	DKJ1375	137,5	DKJ1650	165
DKJ0900	90	DKJ1150	115	DKJ1400	140	DKJ1700	170
DKJ0925	92,5	DKJ1175	117,5	DKJ1425	142,5	DKJ1900	190
DKJ0950	95	DKJ1200	120	DKJ1450	145		

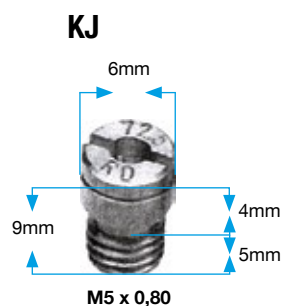

Modelo Keihin CR

Referencia	Medida	Referencia	Medida	Referencia	Medida	Referencia	Medida
DCR0800	80	DCR1200	120	DCR1600	160	DCR2000	200
DCR0820	82	DCR1220	122	DCR1620	162	DCR2020	202
DCR0850	85	DCR1250	125	DCR1650	165	DCR2050	205
DCR0880	88	DCR1280	128	DCR1680	168	DCR2080	208
DCR0900	90	DCR1300	130	DCR1700	170	DCR2100	210
DCR0920	92	DCR1320	132	DCR1720	172	DCR2120	212
DCR0950	95	DCR1350	135	DCR1750	175	DCR2150	215
DCR0980	98	DCR1380	138	DCR1780	178	DCR2180	218
DCR1000	100	DCR1400	140	DCR1800	180	DCR2200	220
DCR1020	102	DCR1420	142	DCR1820	182	DCR2220	222
DCR1050	105	DCR1450	145	DCR1850	185	DCR2250	225
DCR1080	108	DCR1480	148	DCR1880	188	DCR2280	228
DCR1100	110	DCR1500	150	DCR1900	190	DCR2300	230
DCR1120	112	DCR1520	152	DCR1920	192	DCR2320	232
DCR1150	115	DCR1550	155	DCR1950	195	DCR2350	235
DCR1180	118	DCR1580	158	DCR1980	198		

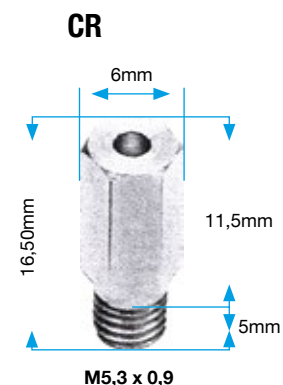



Válvulas aguja de carburador

Las fotografías son a tamaño real.



4PLAY Kit de reparación carburador

HONDA	Año	Referencia	P.V.P.
TRX 250 EX Sportrax	01-04	DAU07161	23,81
TRX 250 EX Sportrax	06-09	DAU07403	23,62
TRX 300 EX Sportrax	93-08	DAU07412	25,48
TRX 350 Rancher	00-03	DAU07208	26,04
TRX 350 Rancher	04-06	DAU07144	23,81
TRX 400 EX Sportrax	99-04	DAU07457	26,64
TRX 400 EX Sportrax	05-14	DAU07458	26,64
TRX 400 Rancher	04-05	DAU07401	25,48
TRX 450 Foreman	98-03	DAU07148	23,25
TRX 450 EX Sportrax	04-05	DAU07452	26,64
TRX 450 EX Sportrax	06-12	DAU07453	28,92
TRX 500 Rubicon	01-04	DAU07400	25,48
TRX 500 Foreman	05-07	DAU07402	25,48
TRX 650 Rubicon	03-05	DAU07442	26,64

KAWASAKI	Año	Referencia	P.V.P.
KLF 220 Bayou	88-98	DAU07209	18,60
KLF 300 Bayou	89-95	DAU07217	18,85
KVF 300 Prairie	99-02	DAU07418	18,85
KVF 360 Prairie	03-07	DAU07406	25,48
KFX 400	03-06	DAU07462	28,92
MULE 3010	todos	DAU07149	23,81
KVF 650 Prairie	02-04	DAU07422	49,85
KVF 650 Brute Force	04-09	DAU07422	49,85
KFX 700	04-09	DAU07446	
KVF 700 Prairie	04-06	DAU07422	49,85
KVF 750 Bruteforce	05-07	DAU07425	37,62

POLARIS	Año	Referencia	P.V.P.
250 Trail Blazer	90-95	DAU07415	25,48
250 Trail Blazer	96-00	DAU07420	25,48
250 Trail Boss	88-99	DAU07415	25,48
250 Xplorer	2000	DAU07420	25,48
300	94-95	DAU07416	25,48
300 Xplorer	96-99	DAU07416	25,48
300 Xpress	96-99	DAU07416	25,48
400 L Sport	94-99	DAU07417	25,48
400 Xplorer	94-95	DAU07417	25,48
400 Xplorer	97-02	DAU07421	25,48
500 Predator	03-07	DAU07461	24,06
500 Scrambler	98-02	DAU07410	25,48
500 Scrambler	03-05	DAU07411	25,48
500 Sportsman	03-05	DAU07411	25,48
700 Sportsman	02-06	DAU07436	28,92

SUZUKI	Año	Referencia	P.V.P.
LT-F 250 Quadrunner	90-96	DAU07223	18,85
LT-A 250 Ozark	02-14	DAU07409	25,48
LT-Z 250	04-09	DAU07445	28,50
LT-A 400 Eiger	03-07	DAU07408	26,04
LT-Z 400	03-08	DAU07462	28,92
LT-F 500 Quadrunner	98-02	DAU07419	28,46
LT-A 500 Vinson	02-07	DAU07434	
LT-F 500 Vinson	03-07	DAU07434	

YAMAHA	Año	Referencia	P.V.P.
YFM 80 Badger	92-01	DAU07147	23,25
YFM 80 Raptor	02-04	DAU07147	23,25
YFB 250 Timberwolf	92-98	DAU07222	18,18
YFM 250 Bear Tracker	99-04	DAU07146	23,25
YFM 350 Grizzly	07-11	DAU07429	24,06
YFM 350 Big Bear	89-92	DAU072071	18,23
YFM 350 Big Bear	93-98	DAU07413	
YFM 350 Raptor	04-13	DAU07443	28,92
YFM 350 Warrior	88-04	DAU07413	25,48
YFM 350 Wolverine	1995	DAU07413	
YFM 350 Wolverine	06-09	DAU07429	24,06
YFZ 350 Banshee	98-06	DAU07463	24,06
YFM 400 Kodiak (semi)	93-98	DAU07413	
YFM 400 Kodiak	00-04	DAU07145	23,81
YFM 400 Big Bear PRO	00-06	DAU07404	25,48
YFM 450 Grizzly	07-14	DAU07426	26,64
YFM 450 Kodiak	03-06	DAU07431	26,64
YFM 450 Wolverine	2006	DAU07431	26,64
YFM 450 Wolverine	07-10	DAU07426	26,64
YFZ 450	04-09	DAU07460	26,64
YFM 600 Grizzly	98-01	DAU07162	23,81
YFM 660 Grizzly	02-08	DAU07405	26,60
YFM 660 Raptor	01-05	DAU07466	26,64
YXR 660 Rhino	04-07	DAU07465	



RUEDAS Y NEUMÁTICOS
MOTOR
ADMISIÓN / ESCAPE / REFRIGERACIÓN
ELECTRICO
SUSPENSIÓN / DIRECCIÓN
FRENS
TRANSMISIÓN
CONTROLES Y MANDOS
CHASIS
ACCESORIOS



Tornillo regulación aire

Tornillo para la mezcla de aire y gasolina, de rápido acceso.
Para carburadores KEIHIN modelo FCR.
Fabricado en aluminio AL6061 T6.

P.V.P
16,78



Referencia	Descripción	P.V.P.
DMX07014RD	Rojo	14,84
DMX07014GN	Verde	14,84
DMX07014GL	Oro	14,84
DMX07014BU	Azul	14,84
DMX07014BK	Negro	14,84
DMX07014TI	Titanio	14,84
DMX07014OR	Naranja	14,84



Tobera admisión

Referencia	Descripción	P.V.P.
DAT07094	Sportsman 600	35,79
DAT07094	Sportsman 700	35,79
DAT07122	Warrior / Raptor 350	39,41



Grifos gasolina

Referencia	Descripción	P.V.P.
DAT07574	Ø 7mm Anclaje Ø 6,6mm a 34mm Tubo 38/29,5mm / 66mm	14,40
DAT07575	Ø 8mm Anclaje Ø 6,6mm a 34mm Tubo 35,8/30mm / 66mm	14,40



Extractor de chiclés

Referencia	P.V.P.
DUP12069	9,63



Destornillador curvo

Referencia	P.V.P.
DUP12840	85,82



Galgas Chiclés

Referencia	Medidas (mm)	P.V.P.
DUP12171	Desde 0,45 - 1,5	10,80
DUP121711	Desde 1,5 a 3,0	10,80



Tubo gasolina NBR 5m

Referencia	Descripción	P.V.P.
DMC07043	Tubo Ø 4,8 mm	9,36
DMC070431	Tubo Ø 6,3 mm	9,81
DMC070432	Tubo Ø 8 mm	17,47



Brida tubo gasolina 10 und.

Referencia	Descripción	P.V.P.
DSM07046	Ø 8,5 mm	1,80
DSM07045	Ø 9,8 mm	2,80
DSM07049	Ø 11,6 mm	3,30
D07238A	Ø 18 mm	4,40



Limpiador de chiclés

Referencia	P.V.P.
DMP12327	5,93



XPEED Tapón gasolina de aluminio

Tapón de aluminio con válvula.
Embelléce tu Quad.



Referencia	Descripción	P.V.P.
R1762011	* Todos los HONDA (excepto Rincón), SUZUKY , KAWASAKY (excepto KFX 450 R) y los YAMAHA (excepto Breeze y Raptor 700)	24,29
R1762071	** Todos los HONDA (excepto Rincón), SUZUKY , KAWASAKY (excepto KFX 450 R) y los YAMAHA (excepto Breeze y Raptor 700)	28,52
R1762012	* YAMAHA Raptor 700 / POLARIS	21,84
R1762072	* YAMAHA Raptor 700 / POLARIS	24,29



P.V.P.
6,09

XPEED Válvula tapón gasolina

Referencia	Descripción
R250BK	Tubo desvaporador Negro
R250BL	Tubo desvaporador Azul
R250R	Tubo desvaporador Rojo
R250GR	Tubo desvaporador Dorado
DMC07371TI	Tubo desvaporador Titanio

XPEED Tapón gasolina con llave

Protege tu depósito de hurtos y gamberradas.



Referencia	Descripción	P.V.P.
GM9531	* YAMAHA Raptor 700 / POLARIS	18,04



Conector rápido gasolina

Referencia	Descripción	P.V.P.
DAT07040	Tubo Ø 6mm	8,23
DAT070401	Tubo Ø 8mm	9,17



Filtro de gasolina

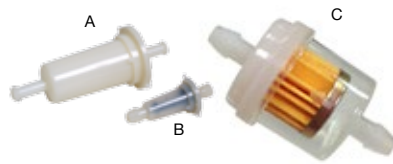

Referencia	Imagen	Descripción	P.V.P.
E14-34441	A	F. Gasolina Grande Ø 6 mm.	0,92
E14-34421	B	F. Gasolina Pequeño Ø 6 mm.	0,79
DUP07101	C	F. Gasolina para tubo Ø 6 mm.	1,20
DUP071011	C	F. Gasolina para tubo Ø 8 mm.	1,30

Saca muelles



Referencia	P.V.P.
DUP12351	6,98

Fibra silencioso 1100°C

Referencia	Largo	Ancho	Grosor	P.V.P.
DMC021111	1000 mm	330 mm	6 mm	19,35



Tapón silencioso



Referencia	Descripción	P.V.P.
DMX02004	Pequeño Ø10 a 30mm	5,34
DMX02005	Grande Ø27 a 49mm	5,95

ADMISIÓN / ESCAPE / REFRIGERACIÓN



Filtros de aire



ARTIC CAT	Año	Referencia	P.V.P.
650	08-10	DAT07310	11,50
700	09-14	DAT07310	11,50
1000	09-13	DAT07311	19,70
Prowler	09-14	DAT07310	11,50

CAN AM	Año	Referencia	P.V.P.
Outlander 330	04-05	DAT07284	24,10
Outlander 400 Carburador	03-08	DAT07284	24,10
Outlander 400 Inyección	08-14	DAT07296	22,30
DS 450	08-12	DAT07285	26,60
Outlander 500	07-09	DAT07283	33,00
Outlander 500	13-14	DAT07298	32,30
Renegade 500	13-14	DAT07298	32,30
DS 650	00-07	DAT07285	26,60
Outlander 650	06-09	DAT07283	33,00
Outlander 650	13-14	DAT07298	32,30
Outlander 800	06-08	DAT07283	33,00
Outlander 800	13-14	DAT07298	32,30
Renegade 800	07-08	DAT07283	33,00
Renegade 800	12-14	DAT07298	32,30
Outlander 1000	13-14	DAT07298	32,30
Renegade 1000	12-14	DAT07298	32,30

HONDA	Año	Referencia	P.V.P.
TRX 250 EX Sportrax	01-11	DAT07074	22,30
TRX 250 Recon	97-12	DAT07074	22,30
TRX 300 FW	89-00	E12-90620	14,80
TRX 300 EX Sportrax	93-12	DAT07251	19,20
TRX 350 Rancher	00-06	E12-90620	14,80
TRX 400 Sportrax	99-11	DAT07077	25,90
TRX 400 Foreman	95-03	DAT07252	14,71
TRX 400 Rancher	04-07	DAT07252	19,10
TRX 420 Rancher	07-14	DAT07089	15,60
TRX 450 Foreman	98-03	DAT07252	14,71
TRX 450 R	06-14	DAT07254	26,40
TRX 500 Rubicon	01-15	DAT07077	25,90
TRX 650 Rincon	03-05	DAT07077	25,90
TRX 680 Rincon	06-16	DAT07077	25,90

KAWASAKI	Año	Referencia	P.V.P.
KLF 220 Bayou	88-98	DAT07009	7,50
KLF 220 Bayou	99-02	DAT07009	7,50
KLF 250 Bayou	03-11	DAT07009	7,50
KSF 250 Mojave	88-04	DAT07258	8,10
KEF 300 Lakota	95-03	DAT07258	8,10
KLF 300 Bayou	88-04	DAT07009	7,50
KVF 300 Prairie	99-02	DAT07009	7,50
KFX 400	03-06	DAT07270	12,60
KLF 400 Bayou	93-99	DAT07009	7,50
KVF 400 Prairie	98-02	DAT07009	7,50
KVF 650 Brute Force	05-13	DAT07262	16,80
KVF 650i Brute Force	06-13	DAT07263	11,70
KVF 650 Prairie	2003	DAT07262	16,80
KFX 700 V-Force	04-09	DAT07262	16,80
KVF 700 Prairie	04-06	DAT07262	16,80
KVF 750i Brute Force	05-14	DAT07263	11,70

POLARIS	Año	Referencia	P.V.P.
200 Phoenix	05-14	DAT07264	26,60
200 Sawtooth	06-07	DAT07264	26,60
250 Trail Blazer	90-06	DAT07264	26,60
250 Trail Boss	88-02	DAT07264	26,60
300	94-95	DAT07264	26,60
300 Hawkeye	06-11	DAT07264	26,60
300 Sportsman	08-10	DAT07264	26,60
325 Magnum	00-01	DAT07043	21,20
325 Magnum	2002	DAT07265	36,60
325 Trail Boss	2001	DAT07265	36,60
325 Xpedition	00-02	DAT07043	21,20
330 Magnum	03-06	DAT07265	36,60
330 Trail Blazer	08-13	DAT07043	21,20
330 Trail Boss	03-09	DAT07265	36,60
330 Trail Boss	10-13	DAT07043	21,20
335 Sportsman	99-00	DAT07043	21,20
335 Worker	1999	DAT07043	21,20
400 Hawkeye	11-12	DAT07043	21,20
400 Scrambler	95-02	DAT07007	9,50
400 L Sport	94-99	DAT07007	9,50
400 Sportsman	01-14	DAT07043	21,20
400 Trail Blazer	2003	E12-94290	12,56
400 Xplorer	99-00	DAT07007	9,50
400 Xplorer	01-02	DAT07264	26,60
400 Xpress	96-97	E12-94290	12,56
425 Xpedition	00-02	DAT07043	21,20
450 Sportsman	06-07	DAT07043	21,20
500 Magnum	99-03	DAT07043	21,20
500 Ranger	06-12	DAT07293	33,40
500 Scrambler	97-12	DAT07043	21,20
500 Sportsman	96-14	DAT07043	21,20
500 Worker	2001	DAT07043	21,20
500 Xplorer	1997	DAT07043	21,20
550 Sportsman	09-14	DAT07043	21,20
600 Sportsman	03-05	DAT07043	21,20
700 Ranger	06-09	DAT07293	33,40
700 Sportsman	03-07	DAT07043	21,20
800 Ranger	11-14	DAT07312	25,50
800 RZR	08-14	DAT07312	25,50
800 Sportsman	05-14	DAT07043	21,20
850 Sportsman	09-14	DAT07043	21,20
900 RZR	11-14	DAT07315	26,40

SUZUKI	Año	Referencia	P.V.P.
LT-F 160 Quadrunner	89-04	DAT07268	12,90
LT-F 250 Ozark	02-12	DAT07269	11,10
LT-Z 250 QuadSport	04-09	DAT07269	11,10
LT-A 400 Eiger	02-07	DAT07270	12,60
LT-A 400 King Quad	08-12	DAT07270	12,60
LT-F 400 Eiger	02-07	DAT07270	12,60
LT-F 400 King Quad	08-12	DAT07270	12,60
LT-Z 400 QuadSport	03-14	DAT07270	12,60
LT-A 450i King Quad	07-11	DAT07271	38,70
LT-A 500 King Quad	09-15	DAT07271	38,70
LT-A 500 Quadrunner	00-01	DAT07271	16,10
LT-A 500 Vinson	02-07	DAT07270	12,60
LT-F 500 Vinson	04-07	DAT07270	12,60
LT-F 500 Quadrunner	98-02	DAT07271	16,10
LT-A 700 King Quad	05-07	DAT07271	38,70
LT-V 700 Twin Peaks	04-05	DAT07262	16,80
LT-A 750i King Quad	08-15	DAT07271	38,70



Filtros de aire



YAMAHA	Año	Referencia	P.V.P.
YFM 50 Raptor	06-08	DAT07274	7,20
YFM 80 Badged	92-01	DAT07274	7,20
YFM 80 Grizzly	05-08	DAT07274	7,20
YFM 80 Raptor	02-08	DAT07274	7,20
YFM 90 Raptor	09-12	DAT07274	7,20
YFM 100 Champ	87-91	DAT07274	7,20
YFB 250 Timberwolf	92-00	DAT07030	10,30
YFM 250 Bear Tracker	99-04	DAT07275	25,40
YFM 250 Big Bear	07-08	DAT07275	25,40
YFM 250 Bruin	05-06	DAT07275	25,40
YFM 350 Big Bear	87-99	E12-95820	11,89
YFM 350 Bruin	04-06	DAT07276	10,90
YFM 350 Grizzly	07-15	DAT07276	10,90
YFM 350 Grizzly IRS	07-11	DAT07276	10,90
YFM 350 Raptor	04-13	E12-95820	11,89
YFM 350 Warrior	87-04	E12-95820	11,89
YFM 350 Wolverine semi.	95-05	E12-95820	11,89
YFM 350 Wolverine	06-09	DAT07276	10,90

YFZ 350 Banshee	87-06	E12-95810	10,15
YFM 400 Big Bear PRO	00-06	DAT07275	25,40
YFM 400 Big Bear IRS	07-12	DAT07276	10,90
YFM 400 Grizzly IRS	2007	DAT07276	10,90
YFM 400 Kodiak auto.	00-06	DAT07276	10,90
YFM 400 Kodiak semi.	93-99	DAT07030	10,30
YFM 450 Grizzly	07-15	DAT07276	10,90
YFM 450 Kodiak	04-06	DAT07276	10,90
YXR 450 Rhino	06-09	E12-95824	10,52
YFM 450 Wolverine	06-11	DAT07276	10,90
YFZ 450 (utilizar adaptador R1734030)	04-09	DAT07254	26,40
YFZ 450 R (utilizar adaptador R1734030)	09-15	DAT07254	26,40
YFM 550 Grizzly	09-15	DAT07159	11,90
YFM 600 Grizzly	98-01	E12-95820	11,89
YFM 660 Grizzly	02-08	E12-95820	11,89
YFM 660 Raptor	01-05	E12-95826	11,01
YXR 660 Rhino	03-07	E12-95824	10,52
YFM 700 Grizzly	07-15	DAT07159	11,90
YFM 700 Raptor	06-15	DAT07093	12,00



Filtro algodón



Filtro de espuma

XPEED Filtros de potencia

Mejora el rendimiento del vehículo y aumenta la protección del carburador y del motor.

* Kit completo consta de filtro algodón, adaptador, pantalla.

** Filtro de aire de algodón con pantalla protectora de regalo.

	*KIT COMPLETO			**FILTRO ALGODÓN		ADAPTADOR		FILTRO ESPUMA	
HONDA	Año	Referencia	P.V.P.	Referencia	P.V.P.	Referencia	P.V.P.	Referencia	P.V.P.
TRX 450R	04-05	R1730010	75,90	R1732010	60,39	R1734010	5,40	R1736010	12,48
TRX 450R	06-09	R1730011	75,90	R1732030	58,50	R1734011	10,15	R1736030	12,48
POLARIS	Año	Referencia	P.V.P.	Referencia	P.V.P.	Referencia	P.V.P.	Referencia	P.V.P.
RZR	08-10	R1730040	93,00	R1732010	60,39	R1734010	5,40	R1736010	12,48
SUZUKI	Año	Referencia	P.V.P.	Referencia	P.V.P.	Referencia	P.V.P.	Referencia	P.V.P.
LTX 400	03-08	R1730020	67,50	R1732020	46,80	R1734020	17,45	R1736020	12,48
LTR 450	06-08	R1730021	71,40	R1732021	49,83	R1734021	15,45	R1736021	12,48
YAMAHA	Año	Referencia	P.V.P.	Referencia	P.V.P.	Referencia	P.V.P.	Referencia	P.V.P.
YFZ 450	04-09	R1730030	79,50	R1732030	58,50	R1734030	16,90	R1736030	12,48
YFM 700 Raptor	06-10	R1730031	69,00	R1732031	49,50	R1734031	17,10	R1736031	12,48
YXR 700 Rhino	07-10	R1730033	96,00	R1732010	60,39	R1734010	5,40	R1736010	12,48

ADMISIÓN / ESCAPE / REFRIGERACIÓN

BRONCO Juntas colector y escape



Referencia	Exterior	Interior	Ancho
DAT02206	46,4	42	25
DAT02207	34,7	28,7	25,2
DAT02208	56,1 / 48,3	41,7	10,2
DAT02209	37,5	31,7	26,7
DAT02210	50	40,2	5
DAT02211	32,7	22,4	4,1
DAT02212	42,4	31,9	3,4
DAT02213	44,7	38,6	5,3
DAT02214	45	37,1	4,1
DAT02215	39,5	30,8	2,5
DAT02216	40,5	32,7	3,7
DAT02217	42	35,3	5,5
DAT02218	43	34,5	5
DAT02219	43	35	4
DAT02220	40	31,7	4,2
DAT02221	54,3 / 44,2	38,6	10,4
DAT02222	41,2	35	26

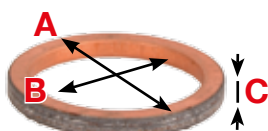

Referencia	Exterior	Interior	Ancho
DAT02223	58,1	42,6 / 43	14
DAT02224	36	32	32
DAT02225	34,6	28,7	28,2
DAT02227	44,3	38,3	24,5
DAT02228	41	35	25
DAT02229	37	32,2	26,2
DAT02230	41,2	35,2	31,3
DAT02231	36,3	31,7	30,7
DAT02234	46,8	42,2	25,5
DAT02235	32,7	28,7	30,5
DMC02205	44,5	38,4	25
DMC02208	31,4	25,5	27,7
DMC02211	37,2	32	25
DMC02213	34,6	28,8	25,5
DMC02218	38,6	35	25,3
DMC02221	38,7	31,7	25
DMC02227	37,4	31,6	30,8

CULATA - COLECTOR					COLECTOR - SILENCIOSO		
HONDA	Año	Ref. Original	Referencia	P.V.P.	Ref. Original	Referencia	P.V.P.
TRX 90	93-05	18391-HB7-000	DMC02208	9,00			
TRX 125	87-88	18291-MN5-650	DAT02220	2,50			
TRX 250	85-87	18291-MN4-920	DAT02219	2,50	18391-ML8-000	DMC02211	9,00
TRX 250	97-01	18291-MN4-920	DAT02219	2,50	18391-HM8-000	DMC02213	9,00
TRX 250 Recon	01-11	18291-MN5-650	DAT02220	2,50			
TRX 250 TE/TM	02-16	18291-MN5-650	DAT02220	2,50	18391-HM8-000	DAT02207	9,00
TRX 250 Sportrax	01-16	18291-MN4-920	DAT02219	2,50	18391-HM8-000	DAT02207	9,00
TRX 300 FW	88-00	18291-MN4-920	DAT02219	2,50			
TRX 300 Sportrax	93-09	18291-MV9-000	DAT02219	2,50	18391-MN5-650	DAT02222	9,00
TRX 350 Rancher	00-06	18291-MN4-920	DAT02219	2,50	18391-ML8-000	DMC02211	9,00
TRX 400	95-97				18391-MN5-650	DAT02222	9,00
TRX 400 Rancher	2007	18291-MN4-920	DAT02219	2,50	18391-MN5-650	DAT02222	9,00
TRX 400 FW	98-03	18291-MN4-920	DAT02219	2,50	18391-MN5-650	DAT02222	9,00
TRX 400 Sportrax	99-02		DAT02220	2,50	18392-MK4-000	DMC02205	9,00
TRX 420 Rancher	07-16	18291-MN4-920	DAT02219	2,50	18391-MN5-650	DAT02222	9,00
TRX 450 Foreman	02-04	18291-MN4-920	DAT02219	2,50	18391-MN5-650	DAT02222	9,00
TRX 450 R	04-05				18392-MK4-000	DMC02205	9,00
TRX 500 Foreman	01-13	18291-MM5-860	DAT02219	2,50	18392-MBH-000	DAT02222	9,00
TRX 500 Rubicon	01-13	18291-MM5-860	DAT02219	2,50	18392-MBH-000	DAT02222	9,00
TRX 650 Rincon	03-05	18291-MM5-860	DAT02214	2,50	18392-MBH-000	DAT02227	9,00
TRX 680 Rincon	06-16	18291-MM5-860	DAT02214	2,50	18392-MBH-000	DAT02227	9,00
TRX 700 XX	08-09				18392-MK4-000	DMC02205	9,00

CULATA - COLECTOR					COLECTOR - SILENCIOSO		
KAWASAKI	Año	Ref. Original	Referencia	P.V.P.	Ref. Original	Referencia	P.V.P.
KLF 220 Bayou	88-02	11009-1866	DAT02215	2,50	11009-1718	DAT02209	9,00
KLF 250 Bayou	03-11	11009-1866	DAT02215	2,50	11009-1718	DAT02209	9,00
KLF 300 Bayou	86-87	11009-1866	DAT02215	2,50	11009-1667	DAT02228	9,00
KLF 300 Bayou	88-05	11009-1866	DAT02215	2,50	11009-1718	DAT02209	9,00
KEF 300 Lakota	95-03	11009-1866	DAT02215	2,50	11009-1718	DAT02209	9,00
KVF 300 Brute Force	12-15	11061-Y032	DAT02256	2,50	11061-Y033	DAT02240	
KVF 300 Prairie	99-02	11009-1866	DAT02215	2,50	11009-1667	DAT02228	9,00
KVF 360 Prairie	03-12				11009-1667	DAT02228	9,00
KLF 400 Bayou	93-99	11009-1866	DAT02215	2,50	11009-1667	DAT02228	9,00
KVF 400 Prairie	97-02	11009-1866	DAT02215	2,50	11009-1667	DAT02228	9,00
KFX 450 R	08-14	11061-0226	DAT02239		11061-0298	DAT02241	
KFX 450 R Colector medio	08-14				11061-0082	DAT02254	2,50
KVF 650 Prairie	02-03	11009-1894	DAT02216	2,50	11061-0360	DAT02229	9,00
KVF 650 Brute Force	05-13	11009-1894	DAT02216	2,50	11061-0360	DAT02229	9,00
KVF 700 Prairie	2004	11009-1894	DAT02216	2,50			
KFX 700	04-09	11009-1894	DAT02216	2,50	11061-0360	DAT02229	9,00
KVF 750 Brute Force	05-14	11009-1894	DAT02216	2,50	11061-0360	DAT02229	9,00
KRF 750 Teryx	08-13	11009-1894	DAT02216	2,50	11061-0360	DAT02229	9,00

ADMISIÓN / ESCAPE / REFRIGERACIÓN

BRONCO Juntas colector y escape



RUEDAS Y NEUMÁTICOS
MOTOR
ADMISIÓN / ESCAPE REFRIGERACIÓN
ELÉCTRICO
SUSPENSIÓN / DIRECCIÓN
FRENS
TRANSMISIÓN
CONTROLES Y MANDOS
CHASIS
ACCESORIOS

POLARIS	CULATA - COLECTOR				COLECTOR - SILENCIOSO		
	Año	Ref. Original	Referencia	P.V.P.	Ref. Original	Referencia	P.V.P.
300 Hawkeye	2006				5249951	DAT02230	9,00
300 Hawkeye	07-11	5243518	DAT02208	10,50	5243518	DAT02208	10,50
300 Sportsman	08-10	5243518	DAT02208	10,50	5243518	DAT02208	10,50
325 Xpedition	00-02	5243517	DAT02221	10,50	5243517	DAT02221	10,50
325 Magnum	00-02	5243517	DAT02221	10,50	5243517	DAT02221	10,50
325 Trail Boss	00-02	5243517	DAT02221	10,50	5243517	DAT02221	10,50
330 Magnum	03-06	5243517	DAT02221	10,50	5243517	DAT02221	10,50
330 Trail Boss	04-12	5243517	DAT02221	10,50	5243517	DAT02221	10,50
330 Trail Blazer	08-13	5243517	DAT02221	10,50	5243517	DAT02221	10,50
400 Ranger	10-12	5243518	DAT02208	10,50	5243518	DAT02208	10,50
400 Sportsman	01-05	5243518	DAT02208	10,50	5243518	DAT02208	10,50
400 Sportsman HO	08-12	5243518	DAT02208	10,50	5243518	DAT02208	10,50
400 Hawkeye HO	11-13	5243518	DAT02208	10,50	5243518	DAT02208	10,50
425 Xpedition	00-02	5243517	DAT02221	10,50	5243517	DAT02221	10,50
450 Sportsman	06-07	5243518	DAT02208	10,50	5243518	DAT02208	10,50
500 Magnum	00-03	5243517	DAT02221	10,50	5243517	DAT02221	10,50
500 Ranger	06-08	5243518	DAT02208	10,50	5243518	DAT02208	10,50
500 Scrambler	00-12	5243518	DAT02208	10,50	5243518	DAT02208	10,50
500 Sportsman	01-13	5243518	DAT02208	10,50	5243518	DAT02208	10,50
570 RZR	12-13	3610181	DAT02236	9,00			
600 Sportsman	03-05	3610047	DSM02038	10,50	3610047	DSM02038	10,50
700 Ranger	07-09	5243518	DAT02208	10,50	5243518	DAT02208	10,50
700 Sportsman	02-06	3610047	DSM02038	10,50	3610047	DSM02038	10,50
700 Sportsman	07-08	3610047	DSM02038	10,50	3610119	DAT02260	
800 Ranger	10-11	5243518	DAT02208	10,50	5243518	DAT02208	10,50
800 Sportsman	05-06	3610047	DSM02038	10,50			
800 Sportsman	07-13	3610047	DSM02038	10,50	3610119	DAT02260	
800 Sportsman	14-15	3610181	DAT02236	9,00	3610119	DAT02260	
800 RZR	08-11	3610047	DSM02038	10,50			
800 RZR	2012	3610181	DAT02236	9,00			

SUZUKI	CULATA - COLECTOR				COLECTOR - SILENCIOSO		
	Año	Ref. Original	Referencia	P.V.P.	Ref. Original	Referencia	P.V.P.
LT-F 250 Quadrunner	88-02	14181-42A00	DAT02218	7,00	14773-14202	DAT02231	10,50
LT-F 250 Ozark	03-12	14181-42A00	DAT02218	7,00	14771-19B00	DAT02231	10,50
LT-Z 250 QuadSport	02-09	14181-42A00	DAT02218	7,00	14771-19B00	DAT02231	10,50
LT-F 300 Kingquad	99-02	14181-42A00	DAT02218	7,00	14771-19B00	DAT02231	10,50
LT-A 400 Eiger	02-07	14181-18C00	DAT02217	7,00	14771-38F00	DMC02221	9,00
LT-F 400 Eiger	02-07	14181-18C00	DAT02217	7,00	14771-38F00	DMC02221	9,00
LT-A 400 King Quad	09-12	14181-18C00	DAT02217	7,00	14771-38F00	DMC02221	9,00
LT-A 450 King quad	07-10	14181-18C00	DAT02217	7,00	14771-13E00	DMC02218	7,50
LT-R 450 Quadracer	06-07	14181-35G00	DAT02252	2,50			
LT-R 450 Quadracer	08-09	14181-35G00	DAT02252	2,50	14771-45G00	DAT02206	13,60
LT-F 500 Quadrunner	98-01	14181-18C00	DAT02217	7,00	14771-13E00	DMC02218	7,50
LT-A 500 Vinson	02-03	14181-18C00	DAT02217	7,00	14771-13E00	DMC02218	7,50
LT-F 500 Vinson	02-03	14181-18C00	DAT02217	7,00	14771-13E00	DMC02218	7,50
LT-A 500 King quad	04-12	14181-18C00	DAT02217	7,00	14771-13E00	DMC02218	7,50
LT-A 550 King Quad	2012	14181-18C00	DAT02217	7,00	14771-13E00	DMC02218	7,50
LT-V 700 Twin Peaks	05-07	14181-29E02	DAT02210	5,00	14771-45G00	DAT02206	13,60
LT-A 750 King Quad	08-12	14181-29E02	DAT02210	5,00	14771-45G00	DAT02206	13,60

YAMAHA	CULATA - COLECTOR				COLECTOR - SILENCIOSO		
	Año	Ref. Original	Referencia	P.V.P.	Ref. Original	Referencia	P.V.P.
YFM 80 Raptor	02-08	3DM-14613-00-00	DAT02211	6,00			
YFM 80 Badger	92-01	3DM-14613-00-00	DAT02211	6,00			
YFA 125 Breeze	91-04	3DM-14613-00-00	DAT02211	6,00			
YFM 125 Grizzly	04-12	3DM-14613-00-00	DAT02211	6,00			
YFM 250 Beartracker	99-04	4BE-14613-00-00	DAT02213	2,50	3YF-14714-00-00	DMC02227	9,00
YFB 250 Timberwolf	94-98	4BE-14613-00-00	DAT02213	2,50	3YF-14714-00-00	DMC02227	9,00
YFM 250 Big Bear	07-09	4BE-14613-00-00	DAT02213	2,50	3YF-14714-00-00	DMC02227	9,00
YFM 350 Bruin	04-06	3GD-14613-00-00	DAT02210	5,00	3YF-14714-00-00	DMC02227	9,00
YFM 350 Grizzly	07-15	3GD-14613-00-00	DAT02210	5,00	3YF-14714-00-00	DMC02227	9,00
YFM 350 Raptor	04-13	3GD-14613-00-00	DAT02210	5,00	4WM-14755-00-00	DAT02206	13,60
YFM 350 Warrior	87-04	3GD-14613-00-00	DAT02210	5,00	3YF-14755-00-00	DAT02234	12,00
YFM 400 Kodiak	00-06	3GD-14613-00-00	DAT02210	5,00	3YF-14714-00-00	DMC02227	9,00
YFM 450 Grizzly	07-15	3GD-14613-00-00	DAT02210	5,00	3YF-14714-00-00	DMC02227	9,00
YFM 450 Kodiak	04-06	3GD-14613-00-00	DAT02210	5,00	3YF-14714-00-00	DMC02227	9,00
YFZ 450	04-13	3VD-14613-00-00	DMX02201	2,50	3FA-14714-01-00	DSM02035	18,61
YFZ 450 R	09-16	3VD-14613-00-00	DMX02201	2,50			
YFM 550 Grizzly	09-15	3YF-14613-01-00	DAT02212	6,00	1HP-E4714-00-00	DAT02223	11,00
YFM 600 Grizzly	98-01	3YF-14613-01-00	DAT02212	6,00	3YF-14755-00-00	DAT02234	12,00
YFM 660 Grizzly	02-08	3YF-14613-01-00	DAT02212	6,00	3YF-14755-00-00	DAT02234	12,00
YFM 660 Raptor	01-05	3YF-14613-01-00	DAT02212	6,00	5LP-14714-00-00	DAT02206	13,60
YFM 660 R(colector medio)	01-05	3YF-14714-00-00	DMC02227	9,00			
YFM 700 Grizzly	07-15	3YF-14613-01-00	DAT02212	6,00	1HP-E4714-00-00	DAT02223	11,00
YFM 700 Raptor	06-15	3YF-14613-01-00	DAT02212	6,00	5LP-14714-00-00	DAT02206	13,60
YFM 700 R(colector medio)	06-15	3YF-14714-00-00	DMC02227	9,00			
YXR 700 Rhino	08-13	3YF-14613-01-00	DAT02212	6,00	3B4-14714-00-00	DAT02223	11,00
YXR 700 Rhino(col. Medio)	08-13	3B4-14714-00-00	DAT02223	11,00			

BRONCO Radiadores

Con su grosor de 40mm, incrementa entre un 20% y un 30% la cantidad de anticongelante, para mejorar la refrigeración.

Aluminio de alta calidad soldado con TIG.

No es necesario modificaciones, se utiliza anclajes y tornillería original.

HONDA	Año	Referencia	Descripción	P.V.P.
TRX 450 R	04-09	DAC10001	Radiador sobredimensionado	140
KAWASAKI	Año	Referencia	Descripción	P.V.P.
KFX 450	08-12	DAC10003	Radiador sobredimensionado	140
POLARIS	Año	Referencia	Descripción	P.V.P.
Outlaw 450 S	08-10	DAC10011	Radiador sobredimensionado	160
Outlaw 500	03-07	DAC10011	Radiador sobredimensionado	160
Predator 500	03-07	DAC10005	Radiador sobredimensionado	140
Outlaw 525	07-11	DAC10011	Radiador sobredimensionado	160
RZR 800	07-12	DAC10010	Radiador sobredimensionado	160
SUZUKI	Año	Referencia	Descripción	P.V.P.
LT-R 450	06-09	DAC10004	Radiador sobredimensionado	140
LT-Z 400	03-08	DAC10012	Radiador sobredimensionado	140
YAMAHA	Año	Referencia	Descripción	P.V.P.
YFZ 350 Banshee	87-07	DAC10000	Radiador sobredimensionado	140
YFZ 450	04-13	DAC10002	Radiador sobredimensionado	140
YXR 450 Rhino	04-09	DAC10007	Radiador sobredimensionado	140
YFM 550 Grizzly	07-14	DAC10014	Radiador sobredimensionado	160
YFM 660 Raptor	01-05	DAC10006	Radiador sobredimensionado	140
YXR 660 Rhino	04-09	DAC10007	Radiador sobredimensionado	140
YFM 700 Grizzly	07-14	DAC10014	Radiador sobredimensionado	160
YFM 700 Raptor	06-13	DAC10008	Radiador sobredimensionado	160

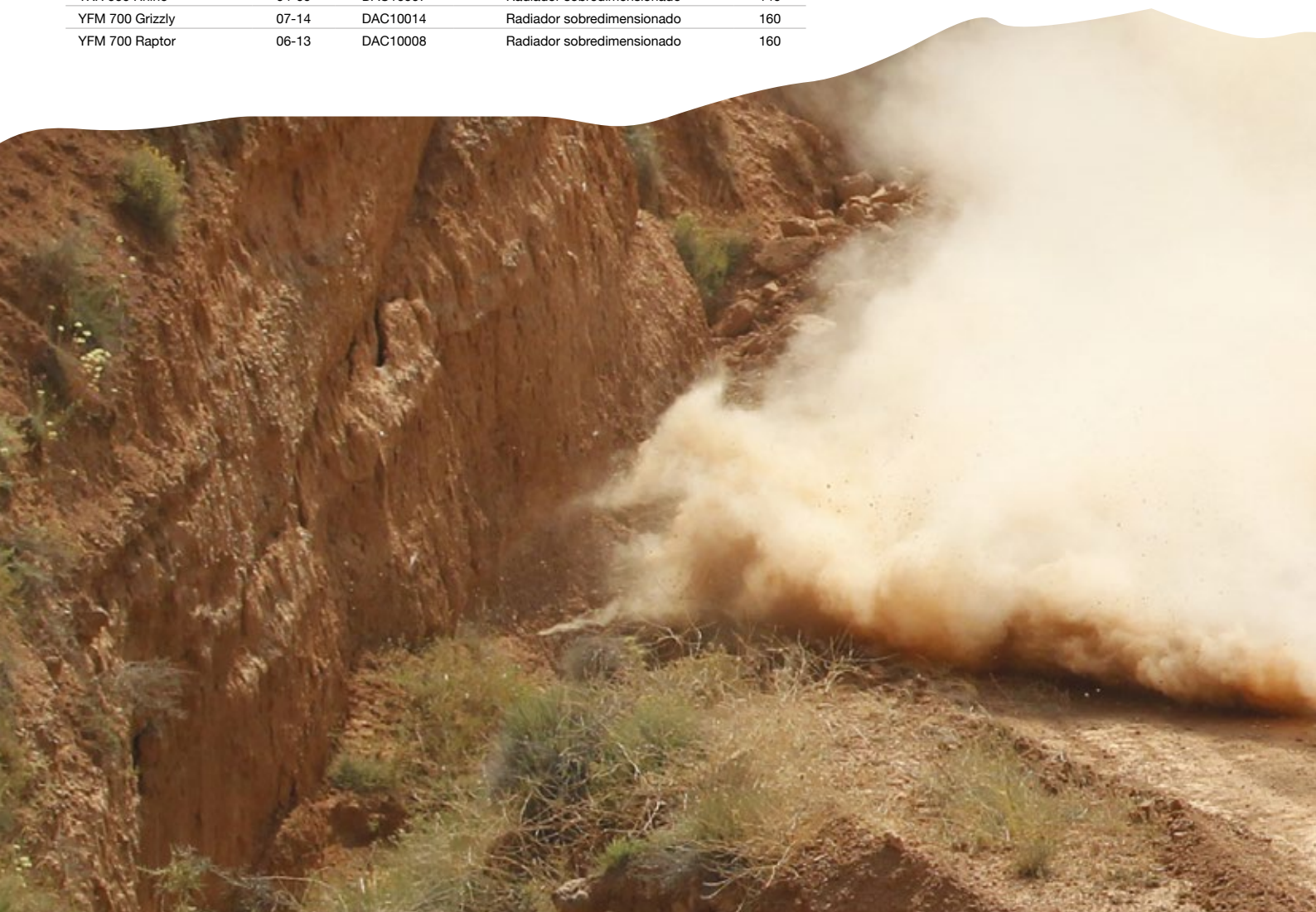



Sensor temperatura

P.V.P
25

KAWASAKI	Año	Referencia
KLF 400 Bayou	93-99	DAT01366
KVF 400 Prairie	97-02	DAT01366
KVF 650 Brute Force	05-13	DAT01366
KVF 650i Brute Force	06-13	DAT01366
KVF 650 Prairie	02-03	DAT01366
KFX 700 V-Force	04-09	DAT01366
KVF 700 Prairie	04-06	DAT01366
KVF 750 Brute Force	05-07	DAT01366
KRF 750 Teryx	2008	DAT01366

POLARIS	Año	Referencia
400 Hawkeye	12-14	DAT01369
400 Hawkeye HO	11-14	DAT01372
400 Scrambler	01-02	DAT01373
400 Sportsman	01-04	DAT01373
400 Sportsman HO	11-14	DAT01372
500 Magnum	00-02	DAT01373
500 Scrambler	01-03	DAT01373
500 Sportsman	00-04	DAT01373
500 Sportsman	03-04	DAT01369
500 Sportsman HO	08-14	DAT01369
500 Outlaw	06-07	DAT01369
500 Predator	04-07	DAT01369
500 Scrambler	2003	DAT01369
500 Sportsman	03-04	DAT01369

500 Sportsman	06-14	DAT01362
500 Sportsman HO	09-13	DAT01369
500 Sportsman HO	09-13	DAT01372
500 Sportsman Forest	11-13	DAT01369
500 Sportsman Forest	11-13	DAT01372
500 Sportsman Touring	10-13	DAT01362
500 Sportsman Touring	10-13	DAT01372
550 Sportsman	10-14	DAT01362
570 Sportsman	2014	DAT01364
600 Sportsman	03-04	DAT01373
700 Sportsman	02-04	DAT01373
700 Sportsman	04-08	DAT01364
800 Sportsman	05-14	DAT01364
850 Sportsman	09-14	DAT01364
850 Scrambler	13-14	DAT01364
1000 Scrambler	2014	DAT01364

YAMAHA	Año	Referencia
YFZ 450 R	09-14	DAT01363
YFM 550 Grizzly	09-14	DAT01363
YFM 700 Grizzly	07-13	DAT01363
YXR 700 Rhino	08-13	DAT01363



DAT01363



DAT01364



- RUEDAS Y NEUMÁTICOS
- MOTOR
- ADMISIÓN / ESCAPE / REFRIGERACIÓN
- ELÉCTRICO
- SUSPENSIÓN / DIRECCIÓN
- FRENOS
- TRANSMISIÓN
- CONTROLES Y MANDOS
- CHASIS
- ACCESORIOS

4PLAY Termocontactos ventilador

El termocontacto conecta a partir de la temperatura marcada

HONDA	Año	Referencia	Descripción	P.V.P.
TRX 350 Rancher	00-06	DAT01382		24,68
TRX 400 Rancher	04-07	DAT01382		24,68
TRX 500 Rubicon	05-14	DAT01382		24,68
TRX 650 Rincon	03-05	DAT01382		24,68
KAWASAKI	Año	Referencia	Descripción	P.V.P.
KLF 400 Bayou	98-99	DAT01386	100 °C	25,61
KVF 400 Prairie	97-02	DAT01386	100 °C	25,61
KVF 650 Brute Force	05-10	DAT01386	100 °C	25,61
KVF 650 Brute Force	11-13	DAT01379	95 °C	25,61
KVF 650i Brute Force	06-10	DAT01386	100 °C	25,61
KVF 650 Prairie	02-03	DAT01386	100 °C	25,61
KFX 700 V-Force	04-09	DAT01386	100 °C	25,61
KVF 700 Prairie	04-06	DAT01386	100 °C	25,61
POLARIS	Año	Referencia	Descripción	P.V.P.
250 Trail Blazer	1998	DAT01377	85 °C	23,89
300 Xpress	96-97	DAT01377	85 °C	23,89
325 Trail Boss	2001	DAT01377	85 °C	23,89
335 Sportsman	2000	DAT01377	85 °C	23,89
400 Scrambler	1999	DAT01377	85 °C	23,89
400 Sportsman	1997	DAT01377	85 °C	23,89
400 Xplorer	97-00	DAT01377	85 °C	23,89
400 Xpress	96-97	DAT01377	85 °C	23,89
400 L	1996	DAT01377	85 °C	23,89
500 Scrambler	97-01	DAT01377	85 °C	23,89
500 Sportsman	96-99	DAT01377	85 °C	23,89
500 Worker	1999	DAT01377	85 °C	23,89
500 Xplorer	1997	DAT01377	85 °C	23,89
SUZUKI	Año	Referencia	Descripción	P.V.P.
LT-Z 400	03-08	DAT01375	85 °C	25,61
LT-A 450 King Quad	07-10	DAT01374	90 °C	25,61
LT-A 450 King Quad	07-10	DAT01375	85 °C	25,61
LT-A 500 King Quad	09-14	DAT01374	85 °C	25,61
LT-A 500 King Quad	09-14	DAT01375	90 °C	25,61
LT-A 500 Vinson	02-07	DAT01375	85 °C	25,61
LT-F 500 Vinson	02-06	DAT01375	85 °C	25,61
LT-F 500 Quad Master	98-01	DAT01375	85 °C	25,61
LT-F 500 Quad Runner	98-02	DAT01375	85 °C	25,61
LT-A 700 King Quad	05-07	DAT01374	90 °C	25,61
LT-A 700 King Quad	05-07	DAT01375	85 °C	25,61
LT-A 750 King Quad	08-13	DAT01374	90 °C	25,61
LT-A 750 King Quad	08-13	DAT01375	85 °C	25,61
YAMAHA	Año	Referencia	Descripción	P.V.P.
YXR 450 Rhino	06-09	DAT01378	75 °C	25,61
YFM 660 Grizzly	02-08	DAT01378	75 °C	25,61
YXR 660 Rhino	04-07	DAT01378	75 °C	25,61
YFM 700 Raptor	2015	DSM01260	25 °C = 1987 ohms 100 °C = 186 ohms	20,33

Difusor temperatura radiador

Ø Interior 13,5mm Ø Exterior 18,8mm

Referencia	P.V.P.
R160010	11,85



Rejas protección radiador

Dimensiones 20x30cm.
Fabricadas en aluminio.

Referencia	P.V.P.
PLATEADA DMP12081S	6,44
NEGRA DMP12081	6,44

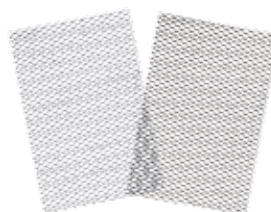

ELÉCTRICO



BRONCO Baterías

Todas las baterías Bronco llevan el ácido incluido. Las baterías sin mantenimiento o las baterías secas sólo se pueden recargar con cargadores de impulsos o de baja intensidad de carga. Todas las baterías llevan el ácido incluido, menos las referencias en azul son baterías Xpeed con mantenimiento y no llevan el ácido incluido.



Las referencias en color azul indican las baterías con mantenimiento.

ARTIC CAT	Año	Referencia	P.V.P.
550 Todos	09-13	YTX20-BS	
700 Todos	09-13	YTX20-BS	
1000 Todos	09-13	YTX20-BS	

CAN AM	Año	Referencia	P.V.P.
Rally 200	02-06	YTX14AH-BS	50,50
Outlander 330	04-05	YTX15L-BS	54,79
Outlander 400	03-04	YTX15L-BS	54,79
Outlander 400 XT	04-12	YTX20L-BS	70,70
Outlander 400 Max	04-12	YTX20L-BS	70,70
DS 450	09-12	YT7B-BS	37,99
DS 650	00-06	YTX15L-BS	54,79
Outlander 650	09-12	YTX20L-BS	70,70
Outlander 650 Max	09-12	YTX20L-BS	70,70
Commander 800	11-13	YTX20L-BS	70,70
Outlander 800	06-12	YTX20L-BS	70,70
Renegade 800	06-12	YTX20L-BS	70,70
Commander 1000	11-13	YTX20L-BS	70,70
Outlander 1000	12-13	YTX20L-BS	70,70
Renegade 1000	12-13	YTX20L-BS	70,70

GAS GAS	Año	Referencia	P.V.P.
Wild 450 HP	todos	YTX9-BS	36,10

GOES	Año	Referencia	P.V.P.
220	todos	YTX12-BS	45,26
300	todos	YTX12-BS	45,26
320	todos	YTX12-BS	45,26
450	todos	YTX9-BS	36,10
520	todos	YTX20L-BS	70,70

HONDA	Año	Referencia	P.V.P.
TRX 250 Recon	97-11	YTX12-BS	45,26
TRX 250 Sportrax	01-12	YTX9-BS	36,10
TRX 300 Sportrax	93-12	YTX9-BS	36,10
TRX 350 Rancher	00-06	YTX14-BS	50,50
TRX 400 Foreman	95-03	YTX14-BS	50,50
TRX 400 Rancher	04-06	YTX14-BS	50,50
TRX 400 Sportrax	99-12	YTX9-BS	36,10
TRX 450 Foreman	98-04	YTX14-BS	50,50
TRX 450 R	06-12	YTZ7S	35,62
TRX 500 Rubicon	01-11	YTX14-BS	50,50
TRX 500 Foreman	05-11	YTX14-BS	50,50
TRX 650 Rincon	03-05	YTX20L-BS	70,70
TRX 680 Rincon	06-12	YTX20L-BS	70,70
TRX 700 xx	08-10	YTX9-BS	36,10

KAWASAKI	Año	Referencia	P.V.P.
KLF 250 Bayou	03-12		
KEF 300 Lakota	95-03	YTX14AH-BS	50,50
KLF 300 Bayou	88-04	YTX14AH-BS	50,50
KVF 300 Prairie	99-02	YTX14AH-BS	50,50
KVF 360 Prairie	09-11	YTX14AH-BS	50,50
KFX 400	03-06	YTX9-BS	36,10
KLF 400 Bayou	93-00	X01163**	43,00
KVF 400 Prairie	97-02	YTX14AH-BS	50,50
KFX 450 R	08-12	YTX7L-BS	29,14
KVF 650 Brute Force	05-11	YTX14-BS	50,50
KVF 650i Brute Force	06-12	YTX14-BS	50,50
KVF 650 Prairie	02-03	YTX14-BS	50,50
KFX 700 V-Force	04-09	YTX14-BS	50,50
KVF 700 Prairie	04-06	YTX14-BS	50,50
KVF 750 Brute Force	05-12	YTX14-BS	50,50

KTM	Año	Referencia	P.V.P.
450 SX	08-11	YTZ7S	35,62
450 XC	08-11	YTZ7S	35,62
505 SX	08-11	YTZ7S	35,62
525 XC	10-11	YTZ7S	35,62

KYMCO	Año	Referencia	P.V.P.
Mongoose 50	todos	YTX5L-BS	22,87
MXU 50	todos	YTX9-BS	36,10
MXU 150	todos	YTX9-BS	36,10
MXU 250	todos	YTX12-BS	45,26
KXR 250	todos	YTX12-BS	45,26
Maxxer 300	todos	YTX12-BS	45,26
MXU 300	todos	YTX12-BS	45,26
MXU 500	todos	YTX20L-BS	70,70
UXV 500	todos	YTX20L-BS	70,70

POLARIS	Año	Referencia	P.V.P.
Phoenix 200	05-12	YTX12-BS	45,26
Sawtooth 200	05-12	YTX12-BS	45,26
todos 250	85-05	YTX14AH-BS	50,50
todos 325	87-02	YTX14AH-BS	50,50
Magnum 330	03-12	YTX14AH-BS	50,50
Sportsman 330	03-12	YTX14AH-BS	50,50
Trail Boss 330	03-12	YTX14AH-BS	50,50
Sportsman 335	98-01	YTX14AH-BS	50,50
todos 400	94-08	YTX14AH-BS	50,50
Sportsman 400	09-11	YTX14AH-BS	50,50
todos 425	95-02	YTX14AH-BS	50,50
Sportsman 500	96-12	YTX14AH-BS	50,50
Sportsman 500 EFI	06-10	YB30L-B	85,46
Outlaw 525	08-11	YTX9-BS	36,10
Sportsman 550	09-10	YTX20HL-BS	75,75
Sportsman 550 EPS	10-12	YTX14AH-BS	50,50
Sportsman 550 XP	10-12	YTX14AH-BS	50,50
Sportsman 600	04-05	YB30L-B	85,46
Sportsman 700	09-10	YB30L-B	85,46
RZR 800	09-12	YTX20L-BS	70,70
RZR 800 4	10-12	YTX20L-BS	70,70
Sportsman 800	05-12	YB30L-B	85,46
Sportsman 850		YB30L-B	85,46

SUZUKI	Año	Referencia	P.V.P.
LT-Z 50 Quad Sport	06-11	YTX5L-BS	22,87
LT 80 Quad Sport	87-06	YTX5L-BS	22,87
LT-Z 90 Quad Sport	07-11	YTX7A-BS	29,14
LT-F 250 Ozark	02-12	YTX12-BS	45,26
LT-Z 250 Quad Sport	04-11	YTX9-BS	36,10
LT-A 400 Eiger	02-07	YTX14-BS	50,50
LT-F 400 Eiger	02-07	YTX14-BS	50,50
LT-Z 400 Quad Sport	03-12	YTX9-BS	36,10
LT-A 400 King Quad	09-12	YTX14-BS	50,50
LT-A 450 King Quad	07-11	YTX14-BS	50,50
LT-R 450 Quad Racer	06-11	YTX7A-BS	29,14
LT-A 500 Quad Master	00-01	YTX16-BS-1	58,70
LT-A 500 Vinson	02-03	YTX16-BS-1	58,70
LT-F 500 Vinson	02-03	YTX16-BS-1	58,70
LT-A 700 King Quad	05-07	YTX16-BS-1	58,70
LT-A 700 King Quad	05-07	YTX20CH-BS	75,75
LT-V 700 Twin Peaks	04-06	YTX14-BS	50,50
LT-A 750 King Quad	07-12	YTX20CH-BS	75,75

YAMAHA	Año	Referencia	P.V.P.
YFM 90 Raptor	09-13	YTZ7S	35,62
YFA1 125 Brezze	89-04	X01123**	25,20
YFM 125 Grizzly	04-13	X01123**	25,20
YFB 250 Timberwolf	92-00	X01123**	25,20
YFM 250 Bear Tracker	99-04	YTX14AH-BS	50,50
YFM 250 Big Bear	07-10	YTX14AH-BS	50,50
YFM 250 Bruin	05-06		
YFM 250 Raptor	08-13	YTZ7S	35,62
YFM 350 Big Bear	87-99	YTX14AH-BS	50,50
YFM 350 Bruin	04-06	YTX14AH-BS	50,50
YFM 350 Grizzly	07-15	YTX14AH-BS	50,50
YFM 350 Wolverine	95-05	X01123**	25,20
YFM 350 Wolverine	06-10	YTX14AH-BS	50,50
YFM 350 Raptor	04-13		
YFM 350 Warrior	87-04	X01123**	25,20
YFM 400 Big Bear	00-12	YTX20L-BS	70,70
YFM 400 Grizzly	07-08	YTX14AH-BS	50,50
YFM 400 Kodiak	93-95	YTX14AH-BS	50,50
YFM 400 Kodiak autom.	00-02	YTX14AH-BS	50,50
YFM 400 Kodiak autom.	03-06	YTX20L-BS	70,70
YFM 450 Grizzly	07-15	YTX20L-BS	70,70
YFM 450 Kodiak	04-06	YTX20L-BS	70,70
YFM 450 Wolverine	03-10	YTX20L-BS	70,70
YFZ 450	04-13	YT7B-BS	37,99
YFZ 450 R	09-15	YTZ7S	35,62
YFM 550 Grizzly	09-15	YTX20L-BS	70,70
YFM 600 Grizzly	98-01	YTX20L-BS	70,70
YFM 660 Grizzly	02-08	YTX20L-BS	70,70
YFM 660 Raptor	01-06	YTX14-BS	50,50
YFM 700 Grizzly	07-15	YTX20L-BS	70,70
YFM 700 Raptor	06-15	YT9B-4	42,76

BRONCO		XPEED	
Referencia	P.V.P.	Referencia	P.V.P.
YB12C-A	25,20		
YTX5L-BS	22,87	X02050	20,45
YTX7L-BS	29,14	X02070	26,90
YTX9-BS	36,10		
YTX12-BS	45,26		
YTX14-BS	50,50		
YTX14AH-BS	50,50		
YTX15L-BS	54,79		
YTX16-BS	58,70		

BRONCO		XPEED	
Referencia	P.V.P.	Referencia	P.V.P.
YTX20-BS			
YTX20L-BS	70,70	YTX20HL-BS	70,70
YTX20CH-BS	75,75		
YTZ7-S	35,62	YTZ7S-BS	35,62
YT7B-BS	37,99	X02072	33,92
YT9B-4	42,76		
YTZ10S	43,83		

BRONCO Baterías sin mantenimiento

Batería sin mantenimiento. Todas llevan el ácido incluido.
YB30L-B: esta batería tiene mantenimiento.



Referencia	Kg.	P.V.P.
YTX4L-BS	1,13	18,59
YTX5L-BS	1,38	22,87
YTX7A-BS	1,86	29,14
YTX7L-BS	1,80	29,14
YTX9-BS	2,23	36,10
YTX12-BS	2,85	45,26

YTX14-BS	3,37	50,50
YTX15L-BS	3,61	54,79
YTX16-BS-1	3,72	58,70
YTX20L-BS	4,39	70,70
YTX14AH-BS	3,36	50,50
YTX20CH-BS	4,20	75,75
YTX20HL-BS	4,39	75,75

YT7B-BS	2,27	37,99
YTZ7S	1,96	35,62
YT9B-4	2,82	42,76
YTZ10S	3,12	43,83
YB30L-B	7,47	85,46

XPEED Baterías

Batería con mantenimiento

Rellenar de ácido y mantenimiento periódico. Ácido no incluido.

Referencia	Descripción	Kg.	P.V.P.
X01030	YB3L - A	1	12,35
X01031	YB3L - B	1	12,35
X01040	YB4L - B	1.3	12,90
X01050	YB5L - B	1.5	20,45
X01070	YB7 - A	2	21,50
X01090	YB9A - A	2.6	26,40
X01091	YB9 - B	2.7	23,10
X01000	YB10L - A2	2.8	26,90
X01101	YB10L - B	2.8	26,90
X01102	YB10L - B2	2.8	26,90
X01120	YB12A - A	3.2	32,25
X01121	YB12A - B	3.2	32,25
X01123	YB12C - A	3.4	25,20
X01140	YB14 - A2	4.1	36,55
X01142	YB14L - A2	4.1	36,55
X01143	YB14L - B2	4.1	36,55
X01160	YB16 - B	3.9	43,00
X01161	YB16AL - A2	4.2	39,80
X01162	YB16B - A1	3.9	39,80
X01163	YB16CL - B	4.5	43,00
X01180	YB18L - A	4.8	49,45
X01181	Y50 - N18L - A	5	51,60
X01182	Y50-N18L-A3	5	51,60
X01240	Y60-N24AL-B	6.5	61,85
X01300	Y60-N30L-A(53030)	7.1	69,90



Batería sin mantenimiento

Rellenar la primera vez de ácido y no necesita mantenimiento.
 Ácido incluido

Referencia	Descripción	Kg.	P.V.P.
X02040	YTR4A - BS	1	20,30
X03040	YT4B-BS	1	20,30
X02050	YT5L - BS	1.6	20,45
X02051	YTX5L - BS	1.6	20,45
X02070	YTX7L - BS	2.1	26,90
X02072	YT7B - BS	1.9	33,92
X02121	YT12B - BS	2.8	40,80

Tabla de medidas de baterías

Referencia	Posición	Ah.	largo x ancho x alto	Kg.	Referencia	Posición	Ah.	largo x ancho x alto	Kg.
12N7D-3B		7	135*75*150	1,78	Y50-N18L-A3		20	205*90*162	5,19
YB3L-A		3	98*56*110	0,97	C60-N24AL-B		28	184*124*175	6,09
YB3L-B		3	98*56*110	0,97	C60-N30L-A		30	184*128*169	6,77
YB4L-B		4	120*70*92	1,18	YB30L-B-1		30	168*132*176	7,47
YB5L-B		5	120*60*130	1,40	YTX5L-BS		4	114*71*106	1,38
YB7-A		7	135*75*133	1,77	YT5L-BS		4	114*71*106	1,38
YB9A-A		9	135*75*155	2,21	YTX7A-BS		6	150*87*94	1,86
YB9-B		9	135*75*139	2,18	YTX7L-BS		6	114*71*131	1,80
YB10A-A2		11	135*90*155	2,98	YTX9-BS		8	150*87*105	2,23
YB10L-A2		11	135*90*145	2,96	YTX12-BS		10	150*87*130	2,85
YB10L-B		11	135*90*145	2,96	YTX14-BS		12	150*87*145	3,37
YB10L-B2		11	135*90*145	2,96	YTX15L-BS		13	175*87*130	3,61
YB12A-A		12	134*80*160	3,10	YTX16-BS-1		14	150*87*161	3,72
YB12A-B		12	134*80*160	3,10	YTX20L-BS		18	175*87*155	4,39
YB12C-A		12	134*80*175	3,12	YTX14AH-BS		12	134*89*166	3,36
YB14-A2		14	134*89*166	3,56	YTX20CH-BS		18	150*87*161	4,20
YB14A-A2		14	134*89*176	3,58	YTX20HL-BS		18	175*87*155	4,39
YB14L-A2		14	134*89*166	3,56	YTR4A-BS		2,3	114*49*86	1,04
YB14L-B2		14	134*89*166	3,56	YT4B-BS		2,5	114*49*86.5	0,98
CB16AL-A2		16	207*71.5*164	3,75	YT7B-BS		6,5	150*65*93	2,27
YB16-B		19	175*100*155	4,51	YTZ7S		6	113*70*105	1,96
YB16B-A1		16	160*90*161	3,71	YT9B-4		8	150*70*105	2,82
YB16CL-B		19	175*100*175	4,72	YTZ10S		8,6	150*87*93	3,12
YB18L-A		18	180*90*162	4,51	YT12B-BS		10	150*69*130	4,05
Y50-N18L-A		20	205*90*162	5,19					





Cargadores baterías



Cargador automático, carga y mantiene

6V/12V. 1Ah. 3 Fases de carga. Para baterías de 2Ah. a 40Ah.
Carga totalmente automática con desconexión al finalizar la carga.
Función de mantenimiento de carga automático.
Apto para todo tipo de baterías, excepto las de litio.

Referencia	P.V.P.
GBA10	38,13



Cargador automático, carga, mantiene y recupera

12V. 1,5Ah. 5 Fases de carga. Para baterías de 4Ah. a 30Ah y mantenimiento hasta 120Ah
Carga totalmente automática con desconexión al finalizar la carga.
Función de mantenimiento de carga automático.
Recupera baterías sulfatadas.
Apto para todo tipo de baterías, excepto las de litio.

Referencia	P.V.P.
GBS15	46,80



Cargador automático profesional, carga, mantiene y recupera

12V. 1Ah/2Ah/4Ah. 7 Fases de carga. Para baterías de 4Ah. a 140Ah.
Carga totalmente automática con desconexión al finalizar la carga.
Función de mantenimiento de carga automático.
Recupera baterías sulfatadas.
Función de eualización.
Apto para todo tipo de baterías, excepto las de litio.

Referencia	P.V.P.
GBS40	62,53



Comprobador de batería y alternador.
Analiza el estado de la batería y verifica el funcionamiento del alternador.

Referencia	P.V.P.
G142	18,43



Kit conexión permanente con fusible.

Referencia	P.V.P.
G129	10,85



Kit encendedor con fusible, para cargar la batería des de la toma del encendedor.

Referencia	P.V.P.
G150	20,56

BRONCO Motor arranque



BRONCO Kit de reparación escobillas

MOTOR COMPLETO				REPARACIÓN
ARTIC CAT	Año	Ref. Original	Referencia	Referencia
250	99-05	3545-003	DAT01116	DAT01162
300	98-05	3545-003	DAT01116	DAT01162
400	03-13	3545-016	DAT01117	
550	09-15	0825-011/13/14	DAT01814	
650	08-11	0825-011/13/14	DAT01814	
700	09-15	0825-011/13/14	DAT01814	
1000	08-12	0825-011/13/14	DAT01814	

MOTOR COMPLETO				REPARACIÓN
CAN AM	Año	Ref. Original	Referencia	Referencia
Outlander 500	07-14	420-684-560	DSM01305	
Renegade 500	08-09	420-684-560	DSM01305	
Outlander 650	06-13	420-684-560	DSM01305	
Commander 800	11-14	420-684-560	DSM01305	
Outlander 800	06-14	420-684-560	DSM01305	
Renegade 800	07-14	420-684-560	DSM01305	
Commander 1000	11-14	420-684-560	DSM01305	
Outlander 1000	2013	420-684-560	DSM01305	
Renegade 1000	12-14	420-684-560	DSM01305	

MOTOR COMPLETO				REPARACIÓN
HONDA	Año	Ref. Original	Referencia	Referencia
TRX 250 Recon	97-07	31200-HN8-003		DAT01145
TRX 250 Sportrax	01-14	31200-HN8-A41		DAT01145
TRX 300	88-00	31200-HC4-033	DAT01069	DAT01145
TRX 300 Sportrax	93-09			DAT01153
TRX 350 Rancher	00-06	31200-HN5-671	DAT01127	DAT01164
TRX 400 Sportrax	99-14	31200-HN1-000	DAT01121	DAT01163
TRX 400 Foreman	95-01			DAT01145
TRX 400 Foreman	02-03			DAT01164
TRX 450 Foreman	98-01			DAT01145
TRX 450 Foreman	02-04			DAT01164
TRX 450 R Sportrax	06-14	31201-MBE-008		DMX01254
TRX 500 Rubicon	04-14	31200-HN2-A01	DAT01102	DAT01145
TRX 500 Foreman	05-11	31200-HMY-A41	DAT01102	DAT01164
TRX 650 Rubicon	03-05	31200-HN8-003	DAT01112	DAT01167
TRX 680 Rincon	06-16	31200-HN8-003	DAT01112	DAT01167

MOTOR COMPLETO				REPARACIÓN
KAWASAKI	Año	Ref. Original	Referencia	Referencia
KFX 80	03-06	21163-S003	DAT01077	
KLF 400 Bayou	93-99	21163-1208	DAT01108	DAT01145
KVF 400 Prairie	97-02	21163-1208	DAT01108	DAT01145
KVF 650 Prairie	02-03	21163-0037	DAT01120	
KVF 650 Brute Force	05-13	21163-0037	DAT01120	
KVF 650i Brute Force	06-13	21163-0037	DAT01120	
KVF 700 Prairie	04-06	21163-0037	DAT01120	
KFX 700	04-09	21163-1320	DAT01120	
KVF 750 Brute Force	05-15	21163-1320	DAT01120	
KRF 750 Teryx	08-15	21163-1320	DAT01120	

MOTOR COMPLETO				REPARACIÓN
POLARIS	Año	Ref. Original	Referencia	Referencia
Trail Blazer 250	03-06	3085393	DAT01067	DAT01142
300	94-95	3084403	DAT01067	DAT01142
XPlorer 300	96-99	3085393	DAT01067	DAT01142
XPress 300	96-99	3085393	DAT01067	DAT01142
Magnum 325	00-02	3084981	DAT01106	DAT01156
Trail Boss 325	00-02	3084981	DAT01106	DAT01156
Magnum 330	03-06	3084981	DAT01106	DAT01156
Trail Blazer 330	08-11	3084981	DAT01106	DAT01156
Trail Boss 330	03-11	3084981	DAT01106	DAT01156
Sportsman 335	99-00	3084981	DAT01106	DAT01156
Worker 335	1999	3084981	DAT01106	DAT01156
Trail Blazer 350	08-09	3084981	DAT01106	DAT01143
400 L	94-95	3084403	DAT01067	
Scrambler 400	95-02	3084403	DAT01067	DAT01142
Sport 400	94-99	3084403	DAT01067	DAT01142
Sportsman 400	94-97	3084403	DAT01067	DAT01142

P.V.P
Según color
de referencia

P.V.P
168

P.V.P
38

P.V.P
18

Sportsman 400	01-05	3084981	DAT01106	DAT01156
Trail Blazer 400	2003	3085393	DAT01067	DAT01142
XPlorer 400	95-02	3084403	DAT01067	DAT01142
XPress 400	96-97	3084403	DAT01067	DAT01142
Sportsman 450	06-07	3084981	DAT01106	DAT01156
Magnum 500	99-03	3084981	DAT01106	DAT01156
Outlaw 500	06-07			DAT01156
Scrambler 500	97-12	3084981	DAT01106	DAT01156
Sportsman 500	96-12	3084981	DAT01106	DAT01156
Predator 500	03-07			DAT01143
Worker 500	1999	3084981	DAT01106	DAT01156
XPlorer 500	1997	3084981	DAT01106	DAT01156
Sportsman 600	03-05		DAT01103	DAT01167
Ranger 700	07-09		DAT01103	DAT01167
Sportsman 700	04-08		DAT01103	DAT01167
Sportsman 800	05-14		DAT01103	DAT01167
RZR 800	08-09		DAT01103	DAT01167
RZR 900	11-12	4013059	DAT01807	

MOTOR COMPLETO				REPARACIÓN
SUZUKI	Año	Ref. Original	Referencia	Referencia
LT 80	87-06	31100-40B01	DAT01077	DAT01139
LT-F 160 QuadrRunner	91-99	31100-02C02	DAT01128	DAT01145
LT-F 160 QuadrRunner	00-04			DAT01145
LT-F 250 Ozark	02-14	31100-19B11	DAT01116	DAT01145
LT-F 250 QuadrRunner	88-09	31100-19B11	DAT01116	DAT01145
LT-Z 250	04-09			DAT01145
LT-F 300 King Quad	99-02	31100-19B20	DAT01116	DAT01145
LT-A 400 Eiger	02-07	31100-38F00	DAT01117	DAT01179
LT-A 400 King Quad	08-10	31100-38F00	DAT01117	DAT01179
LT-F 400 King Quad	08-10	31100-38F00	DAT01117	DAT01179
LT-F 400 Ozark	02-09			DAT01145
LT-A 450 King Quad	07-10		DAT01104	
LT-A 500	98-06			DAT01162
LT-A 500 King Quad	09-14		DAT01104	
LT-V 700 Twin Peaks	04-05	K2116-31320	DAT01120	DAT01162
LT-A 700 King Quad	05-07			DAT01162
LT-A 750 King Quad	08-09			DAT01162

MOTOR COMPLETO				REPARACIÓN
YAMAHA	Año	Ref. Original	Referencia	Referencia
YFM 50 Raptor	04-09	55X-81800-51	DAT01075	DAT01172
YFM 80 Badger	86-01	55X-81800-51	DAT01075	DAT01172
YFM 80 Grizzly	05-08	55X-81800-51	DAT01075	DAT01172
YFM 80 Raptor	02-08	55X-81800-51	DAT01075	DAT01172
YFM 100 Champ	90-91	55X-81800-51	DAT01075	DAT01172
YFA 125 Breeze	95-04	3FA-81800-01	DAT01114	DAT011351
YFM 125 Grizzly	04-13	3FA-81800-01	DAT01114	DAT011351
YFM 250 Bear Tracker	99-04	4XE-81890-00	DAT01107	DAT01133
YFM 250 Big Bear	07-11	5XG-H1800-00	DAT01076	
YFM 250 Bruin	05-06	5XG-H1800-00	DAT01076	
YFB 250 Timberwolf	92-98	4BD-81800-00	DAT01107	DAT01133
YFM 350 Big Bear	89-99	2HR-81800-52	DAT01122	DAT01141
YFM 350 R Raptor	04-13	1UY-81890-00	DAT01066	DAT01056
YFM 350 Warrior	90-01	1UY-81800-51	DAT01066	DAT01056
YFM 350 Warrior	02-04	1UY-81890-00	DAT01066	DAT01056
YFM 350 Wolverine	96-05	4KB-81800-00	DAT01122	DAT01141
YFM 350 Wolverine	06-09	3HE-81890-00		
YFM 400 Big Bear Pro	02-03	1UY-81890-00	DAT01066	DAT01130
YFM 400 Kodiak	93-98	2HR-81800-52	DAT01066	DAT01130
YFM 400 Kodiak	1999	4KB-81800-00	DAT01122	DAT01141
YFM 400 Kodiak Autom.	00-02	4WV-81890-00	DAT01113	
YFM 400 Kodiak Autom.	03-06	5KM-81890-00	DAT01113	DAT01054
YFM 450 Grizzly	07-10	5KM-81890-00	DAT01113	DAT01054
YFM 450 Kodiak	03-06	5KM-81890-00	DAT01113	DAT01054
YFM 450 Wolverine	06-10	5KM-81890-00	DAT01113	DAT01054
YFZ 450	04-14	5TG-81890-00	DAT01113	
YFZ 450 R	04-14	5TG-81890-00	DAT01113	
YXR 450 Rhino	06-08	5KM-81890-00	DAT01113	DAT01054
YFM 550 Grizzly	09-10	1S3-81890-00		DAT01054
YFM 600 Grizzly	98-01	4WV-81890-00	DAT01113	DAT01054
YFM 660 Grizzly	02-08	5KM-81890-00	DAT01113	DAT01054
YFM 660 Raptor	01-05	3SX-81890-00	DAT01109	DAT01167
YXR 660 Rhino	04-07	5KM-81890-00	DAT01113	DAT01155
YFM 700 Grizzly	07-08	1S3-81890-00		DAT01054
YFM 700 Grizzly	09-14	28P-81890-00	DAT01086	DAT01054
YFM 700 Raptor	06-14	1S3-81890-00		DAT01054
YXR 700 Rhino	08-13	1S3-81890-00	DAT01113	DAT01054

BRONCO Bendix Polaris

Referencia	Descripción	P.V.P.
DAT01068	Hasta 500cc 2 y 4t.	54,98
DAT01150		98,00



BRONCO Bobina encendido



CAN AM	Año	Referencia	P.V.P.
Traxter	03-10	DSM01149	118,80
Outlander 500	09-15	DSM01149	118,80
Renegade 500	09-15	DSM01149	118,80
Outlander 650	09-15	DSM01149	118,80
Commander 800	11-15	DSM01149	118,80
Outlander 800	09-10	DSM01149	118,80
Renegade 800	09-13	DSM01149	118,80
Commander 1000	11-15	DSM01149	118,80
Maverick 1000	14-15	DSM01149	118,80
Outlander 1000	12-15	DSM01149	118,80
Renegade 1000	12-15	DSM01149	118,80

HONDA	Año	Referencia	P.V.P.
TRX 250 R	86-89	DAT01300	27,89
TRX 250 D Recon	97-01	DAT01300	27,89
TRX300EX	93-06	DAT01300	27,89
TRX350 FE / FM / TE / TM Rancher	00-06	DAT01300	27,89
TRX400EX	99-06	DAT01311	42,90
TRX400FW	95-03	DAT01300	27,89
TRX450FE/FM	98-04	DAT01300	27,89

KAWASAKI	Año	Referencia	P.V.P.
KLF 300 Bayou 2X4	86-04	DAT01314	47,61
KLF 300 Bayou 4X4	89-96	DAT01314	47,61
KLF 300 Bayou 4X4	97-04	DAT01315	46,12
KVF 360 Prairie	03-12	DAT01316	31,96
KVF 650 Prairie 4X4	02-03	DAT01316	31,96
KVF 650 Brute Force 4x4	05-13	DAT01316	31,96
KVF 700 Praire 4x4	04-06	DAT01316	31,96

POLARIS	Año	Referencia	P.V.P.
250 Trail Blazer	99-03	DAT01319	33,03
250 Trail Boss	88-98	DAT01319	33,03
330 ATP	03-06	DAT01344	23,60
330 Magnum	03-05	DAT01344	23,60
330 Trail Blazer	08-13	DAT01344	23,60
330 Trail Boss	02-13	DAT01344	23,60
335 Sportsman	1999	DAT01319	33,03
335 Worker	1999	DAT01319	33,03
350 L	1993	DAT01319	33,03
400 L	94-95	DAT01319	33,03
400 Hawkeye	11-14	DAT01319	33,03
400 Scrambler	97-02	DAT01319	33,03
400 L Sport	94-99	DAT01319	33,03
400 Ranger	10-14	DAT01319	33,03
400 Sportsman	97-14	DAT01319	33,03
400 Trail Blazer	2003	DAT01319	33,03
425 Xpedition	00-02	DAT01319	33,03
500 Magnum	00-03	DAT01319	33,03
ATP 500	2004	DAT01319	33,03
500 Magnum	95-02	DAT01319	33,03
500 Predator	03-07	DAT01305	33,03
500 Ranger	04-11	DAT01319	33,03
500 Scrambler	95-11	DAT01319	33,03
500 Sportsman	96-13	DAT01319	33,03
700 Ranger	05-09	DSM01149	118,80
700 Sportsman	04-08	DSM01149	118,80
800 Ranger	10-15	DSM01149	118,80
800 RZR	08-14	DSM01149	118,80
800 RZR S	12-14	DSM01149	118,80

800 RZR 4	12-14	DSM01149	118,80
800 Sportsman	07-13	DSM01149	118,80
850 Sportsman	09-15	DSM01149	118,80
900 Ranger	12,15	DSM01149	118,80
900 RZR	11-15	DSM01149	118,80
900 RZR 4	14-15	DSM01149	118,80
1000 RZR XP	14-15	DSM01149	118,80
1000 RZR XP 4	14-15	DSM01149	118,80
1000 Sportsman	14-15	DSM01149	118,80
1000 Scrambler	14-15	DSM01149	118,80

SUZUKI	Año	Referencia	P.V.P.
LT 160	89-04	DAT01318	30,46
LT 250 R Quad Racer	87-91	DAT01318	30,46
LT-F 250 Quad Runner	90-00	DAT01317	38,18
LT 500 R Quad Racer	87-89	DAT01318	30,46
LT-F 300 King Quad	91-98	DAT01317	38,18
LT-F 300 King Quad	99-00	DAT01317	38,18
LT-Z 400 Quad Sport	03-08	DAT01318	30,46
LT-A 450 King Quad	07-10	DAT01318	30,46
LT-F 500 Quad Runner	98-02	DAT01318	30,46
LT-A 500 King Quad	09-14	DAT01318	30,46
LT-A 500 Vinson	02-07	DAT01318	30,46
LT-F 500 Vinson	04-07	DAT01318	30,46
LT-A 700 King Quad	05-07	DAT01318	30,46
LT-F 750 King Quad	08-13	DAT01318	30,46

YAMAHA	Año	Referencia	P.V.P.
YFM 50 R Raptor	04-06	DAT01318	30,46
YFM 80 Badger	00-01	DAT01318	30,46
YFM 80 Grizzly	2006	DAT01318	30,46
YFM 80 Raptor	02-06	DAT01318	30,46
YFA1 125 Breeze	99-04	DAT01318	30,46
YFM 125 Grizzly	05-06	DAT01318	30,46
YFS 200 Blaster	95-96	DAT01307	31,96
YFS 200 Blaster	97-06	DAT01308	30,46
YFM 250 Beartracker	99-04	DAT01318	30,46
YFM 250 Bruin	05-06	DAT01318	30,46
YFM 250 Big Bear	07-09	DAT01318	30,46
YFB 250 Timberwolf	95-00	DAT01308	30,46
YFM 350 Big Bear	95-98	DAT01308	30,46
YFM 350 Big Bear	1999	DAT01318	30,46
YFM 350 Banshee	95-06	DAT01309	88,90
YFM 350 Raptor	04-13	DAT01318	30,46
YFM 350 Warrior	89-01	DAT01308	30,46
YFM 350 Warrior	02-04	DMX01002	23,89
YFM 350 Wolverine	96-01	DAT01308	30,46
YFM 400 Kodiak semiauto.	93-96	DAT01306	38,18
YFM 400 Kodiak semiauto.	97-98	DAT01308	30,46
YFM 400 Kodiak	99-06	DAT01318	30,46
YFM 400 Grizzly	07-08	DAT01318	30,46
YFM 450 Grizzly	07-14	DAT01318	30,46
YFM 450 Kodiak	03-06	DAT01318	30,46
YFM 450 Wolverine	06-10	DAT01318	30,46
YFM 550 Grizzly	08-15	DAT01342	
YFM 600 Grizzly	98-00	DAT01318	30,46
YFM 660 Grizzly	01-06	DAT01318	30,46
YFM 660 R Raptor	01-05	DAT01318	30,46
YFM 700 Grizzly	2007	DAT01343	31,96
YFM 700 Grizzly	08-15	DAT01342	
YFM 700 Raptor	06-15	DAT01343	31,96

RUEDAS Y NEUMÁTICOS

MOTOR

ADMISIÓN / ESCAPE REFRIGERACIÓN

ELÉCTRICO

SUSPENSIÓN / DIRECCIÓN

FRENOS

TRANSMISIÓN

CONTROLES Y MANDOS

CHASIS

ACCESORIOS

BRONCO Pickup

P.V.P.
22



HONDA	Año	Cable	Referencia
TRX 200 Fourtrax	90-96		DAT01094
TRX 250 R Fourtrax	89-92		DAT01094
TRX 250 Recon	97-16		DAT01094
TRX 250 Sportrax	01-16		DAT01094
TRX 300 EX Sportrax	93-09		DAT01094
TRX 300 FW	89-95		DAT01094
TRX 350 Rancher	00-06		DAT01094
TRX 400 Foreman	95-03		DAT01094
TRX 400 Rancher	04-07		DAT01094
TRX 450 Foreman	98-04		DAT01094
TRX 500 Rubicon	01-16		DAT01094
TRX 650 Rincon	03-05		DAT01094
TRX 680 Rincon	06-14		DAT01619

KAWASAKI	Año	Cable	Referencia
KLF 220 Bayou	88-95	1170 mm	DAT01608
KLF 220 Bayou	96-02	310 mm	DAT01607
KLF 250 Bayou	03-11	310 mm	DAT01607
KLF 300 Bayou	88-04	570 mm	DAT01606
KEF 300 Lakota	95-02	570 mm	DAT01606
KVF 300 Prairie	99-02	580 mm	DAT01604
KVF 360 Prairie	03-13	110 mm	DAT01612
KVF 400 Prairie	98-02	110 mm	DAT01612
KVF 650 Brute Force	05-13	970 mm	DAT01605
KVF 650i Brute Force	06-13	970 mm	DAT01605
KVF 650 Prairie	02-03	970 mm	DAT01605
KFX 700 V-Force	04-09	970 mm	DAT01605
KVF 700 Prairie	04-09	970 mm	DAT01605
KRF 750 Teryx	08-13	970 mm	DAT01605

POLARIS	Año	Cable	Referencia
250 Trail Boss	92-99		DAT01617
250 Trail Blazer	91-06		DAT01617
335 Sportsman	99-00	50 mm	DAT01609
400 Trail Blazer	2003		DAT01617
400 Sportsman	01-04	50 mm	DAT01609
425 Magnum	95-98	50 mm	DAT01609
500 Magnum	99-03	50 mm	DAT01609
500 Ranger	06-09	50 mm	DAT01609
500 Scrambler	97-03	50 mm	DAT01609
500 Sportsman	96-04	50 mm	DAT01609
500 Xplorer	1997	50 mm	DAT01609

SUZUKI	Año	Cable	Referencia
LT-A 400 Eiger	02-07	110 mm	DAT01612
LT-A 400 King Quad	08-09	110 mm	DAT01612
LT-Z 400 Quadsport	03-09	110 mm	DAT01612
LT-R 450 Quadracer	06-09	110 mm	DAT01612

YAMAHA	Año	Cable	Referencia
YFS 200 Blaster	88-06	110 mm	DAT01611
YFM 350 Warrior	87-04	110 mm	DAT016121
YFM 350 Raptor	04-13	110 mm	DAT016121
YFM 350 Bruin	04-06	110 mm	DAT016121
YFM 350 Wolverine	06-08	110 mm	DAT016121
YFM 350 Big Bear	87-99	110 mm	DAT016121
YFM 350 Grizzly	07-14	110 mm	DAT016121
YFM 400 Grizzly	07-08	110 mm	DAT016121
YFM 400 Kodiak	03-06	110 mm	DAT016121
YFM 450 Grizzly	07-14	110 mm	DAT016121
YFM 450 Kodiak	03-06	110 mm	DAT016121
YFM 450 Wolverine	06-10	110 mm	DAT016121
YFM 660 Raptor	01-05	110 mm	DAT016121
YFM 660 Grizzly	02-08	110 mm	DAT016121
YFM 700 Raptor	06-16	110 mm	DAT016121
YXR 660 Rhino	03-07	110 mm	DAT016121

Relés de arranque



Referencia	Descripción	P.V.P.
DAT01097	12V 80A HONDA	20,93



Referencia	Descripción	P.V.P.
DAT01098	POLARIS	20,00



Referencia	Descripción	P.V.P.
DAT01100	YAMAHA Carburación	39,84



Referencia	Descripción	P.V.P.
DAT01105	YAMAHA HONDA	21,55



Referencia	Descripción	P.V.P.
DAT01751	HONDA	14,73



Referencia	Descripción	P.V.P.
DMC01696	12V 30A SUZUKI	24,03



Referencia	Descripción	P.V.P.
DAT01752	CAN AM	16,52



Referencia	Descripción	P.V.P.
DAT01099		20,00



Referencia	Descripción	P.V.P.
DAT01101	HONDA	



Bujías NGK

El modelo de bujía puede tener opcionales según año y versión del vehículo.

Más modelos en pág. 55



ARTIC CAT

Referencia	P.V.P.
1000 ATV	10,14

CAN AM

Referencia	P.V.P.
Rally 200	BR9ECS 10,14
DS 250	CR8E 10,14
Outlander 330	DCPR8E 8,38
Outlander 400	DCPR8E 8,38
DS 450	DCPR9E 8,38
Outlander 500	DCPR8E 8,38
Renegade 500	DCPR8E 8,38
DS 650	DR8EA 4,84
Outlander 650	DCPR8E 8,38
Outlander 800	DCPR8E 8,38
Renegade 800	DCPR8E 8,38
Commander 800	DCPR8E 8,38
Outlander 1000	DCPR8E 8,38
Renegade 1000	DCPR8E 8,38
Commander 1000	DCPR8E 8,38

GAS GAS

Referencia	P.V.P.
Wild 300	BR8EG 10,14
Wild 450	CR8E 10,14

HONDA

Referencia	P.V.P.
TRX 250 EX Sportrax	DPR8EA-9 4,84
TRX 250 Recon	DPR8EA-9 4,84
TRX 300 EX Sportrax	DR8ESL 4,84
TRX 350 Rancher	DPR7EA-9 4,84
TRX 400 Sportrax	DPR8Z 10,14
TRX 400 Foreman / Rancher	DPR7EA-9 4,84
TRX 400 Rancher	DPR8EA-9 4,84
TRX 450 Foreman	DPR7EA-9 4,84
TRX 450 R	DPR7EA-9 4,84

KAWASAKI

Referencia	P.V.P.
KLF 220 Bayou	DR8ES 4,84
KLF 250 Bayou	DR8ES 4,84
KSF 250 Mojave	DPR8EA-9 4,84
KEF 300 Lakota	DR7EA 4,71
KLF 300 Bayou	DR7EA 4,71
KVF 300 Brute Force	DR8EA 4,84
KVF 300 Prairie	DR8EA 4,84
KVF 360 Prairie	DPR8EA-9 4,84
KFX 400	CR7E 10,14
KLF 400 Bayou	DPR8EA-9 4,84
KVF 400 Prairie	DPR8EA-9 4,84
KVF 650 Brute Force	CR7E 10,14
KVF 650I Brute Force	CR7E 10,14
KVF 650 Prairie	CR7E 10,14

KFX 700 V-Force	CR7E	10,14
KVF 700 Prairie	CR7E	10,14
KVF 750I Brute Force	CR7E	10,14

KYMCO

Referencia	P.V.P.
Mxer 50	BR8HSA 4,71
Mxer 150	DR8EA 4,84
KXR 250	DPR7EA-9 4,84
MXU 250	DPR7EA-9 4,84
Maxxer 300	DPR7EA-9 4,84
MXU 400	CR8E 10,14
MXU 500	CR8E 10,14

KTM

Referencia	P.V.P.
SX 450	CR9EKB 14,83
XC 450	CR9EKB 14,83
SX 505	CR9EKB 14,83
XC 525	DCPR8E 8,38

POLARIS

Referencia	P.V.P.
200 Phoenix	CR7HSA 4,71
250 Trail Blazer	BR8ES 4,84
250 Trail Boss	BR8ES 4,84
300 Hawkeye	BR8ES 4,84
300 Sportsman	BR8ES 4,84
300 Trail Boss	BR8ES 4,84
335 Sportsman	BKR7E 5,31
400 Hawkeye	BR8ES 4,84
400 Scrambler	BR8ES 4,84
400 Sportsman	BKR5ES 4,63
400 Trail Blazer	BR8ES 4,84
400 Xplorer	BR8ES 4,84
400 Xpress	BR8ES 4,84
425 Xpedition	BKR5ES 4,63
500 Magnum	BKR5ES 4,63
500 Outlaw	DCPR8E 8,38
500 Predator	DCPR8E 8,38
500 Ranger	BKR5ES 4,63
500 Scrambler	BKR5ES 4,63
500 Sportsman	BKR5ES 4,63
500 Xplorer	BKR5ES 4,63
525 Outlaw	DCPR8E 8,38
600 Sportsman	BKR7E 5,31
700 Sportsman	BKR7E 5,31
800 Sportsman	BKR7E 5,31

SUZUKI

Referencia	P.V.P.
LTF 160 Quadrunner	DPR7EA-9 4,84
LT 230 Quadrunner	DR7EA 4,71
LT-F 250 Ozark	DR7EA 4,71
LT-Z 250 QuadSport	DR8EA 4,84
LT 300 Quadrunner	DR8EA 4,84

LT-F 300 King Quad	DR7EA	4,71
LT-A 400 Eiger	CR7E	10,14
LT-A 400 King Quad	CR7E	10,14
LT-Z 400 QuadSport	CR7E	10,14
LT-A 450I King Quad	CR7E	10,14
LT-R 450	CR8EB	10,14
LT-A 500 King Quad	CR7E	10,14
LT-A 500 Quadrunner	CR7E	10,14
LT-A 500 Vinson	CR7E	10,14
LT-F 500 Quadrunner	CR7E	10,14
LT-A 550 King Quad	CR7E	10,14
LT-A 700 King Quad	CR8E	10,14
LT-V 700 Twin Peaks	CR7E	10,14
LT-A 750I King Quad	CR7E	10,14

YAMAHA

Referencia	P.V.P.
YFA 125 Breeze	CR7HSA 4,71
YFM 125 Grizzly	CR7HSA 4,71
YFS 200 Blaster	BR8ES 4,84
YFM 250 Bear Tracker	DR7EA 4,71
YFM 250 Big Bear	DR7EA 4,71
YFM 250 Bruin	DR7EA 4,71
YFM 250 Raptor	DR7EA 4,71
YFM 300 Grizzly	DPR7EA-9 4,84
YFM 350 Big Bear	DR8EA 4,84
YFM 350 Bruin	DR8EA 4,84
YFM 350 Grizzly	DR8EA 4,84
YFM 350 Raptor	DR8EA 4,84
YFM 350 Warrior	DR8EA 4,84
YFM 350 Wolverine	DR8EA 4,84
YFZ 350 Banshee	BR8ES 4,84
YFM 400 Big Bear	DR8EA 4,84
YFM 400 Grizzly	DR8EA 4,84
YFM 400 Kodiak	DR8EA 4,84
YFM 450 Grizzly	DR8EA 4,84
YFM 450 Kodiak	DR8EA 4,84
YXR 450 Rhino	DR8EA 4,84
YFM 450 Wolverine	DR8EA 4,84
YFZ 450	CR8E 10,14
YFZ 450 R	CR8E 10,14
YFM 550 Grizzly	LMAR6A-9 24,53
YFM 600 Grizzly	DPR8EA-9 4,84
YFM 660 Grizzly	DPR8EA-9 4,84
YFM 660 Raptor	DPR8EA-9 4,84
YXR 660 Rhino	DPR8EA-9 4,84
YFM 700 Grizzly	CPR7EA-9 10,14
YFM 700 Raptor	CR8E 10,14
YXR 700 Rhino	CPR7EA-9 10,14



Referencia	Descripción	P.V.P.
E28-47800	Silicona	1,25



Referencia	Descripción	P.V.P.
D0110904	Tipo NGK	2,22



Referencia	Descripción	P.V.P.
D01110B	Con cable 50cm	3,90



Referencia	Descripción	P.V.P.
D0110924	Silicona con resistencia	5,99



Referencia	Descripción	P.V.P.
D0110923	Silicona con resistencia	5,99



Referencia	Descripción	P.V.P.
XMC12227	Funda de bujía	2,65

Pilotos homologados



Piloto Raptor 700
YFZ 450 (06-13)

Referencia	P.V.P.
DSM01108	49,45



Tulipa Raptor 350 / 660

Referencia	P.V.P.
DAT01084E	7,63



Piloto Raptor 350 / 660

Referencia	P.V.P.
DAT01085E	29,85



Piloto Yamaha homologado

Referencia	P.V.P.
XT1101	12,46



Tulipa Yamaha homologada

Referencia	P.V.P.
XT1103	7,75

Intermitentes homologados

Intermitentes universales homologados de fácil instalación.



Ref.	Descripción	P.V.P.
V1621	Tras. Izq. / Del. Der.	7,25
V1622	Tras. Der. / Del. Izq.	7,25



Ref.	Descripción	P.V.P.
V1612	Tras. Izq. / Del. Der.	7,95
V1613	Tras. Der. / Del. Izq.	7,95



Ref.	Descripción	P.V.P.
DMC01321-1	12V 10W derecha	6,82
DMC01321-2	12V 10W izquierda	6,82



Ref.	Descripción	P.V.P.
DMC01331E	12V 21W Juego 2 int.	12,60



Ref.	Descripción	P.V.P.
DMC013301E	12V 21W Juego 2 int.	21,84



Ref.	Descripción	P.V.P.
DMC01330E	12V 21W Juego 2 int.	21,84



Ref.	Descripción	P.V.P.
D15921	12V 21W Juego 2 int.	12,18

Ópticas homologadas



Óptica ATV Yamaha

Referencia	P.V.P.
XT1001	28,68



Óptica deportivos

Ref.	Descripción	P.V.P.
XT1010	Óptica homologada	25,36
XT1011	Óptica homologada con cable y soportes	42,75



Óptica ATV

Referencia	Descripción	P.V.P.
XT1020	Sin lamparas	18,79

Conmutadores



Referencia	Descripción	P.V.P.
V1650	YAMAHA	14,14



Intermitentes y claxon

Referencia	Descripción	P.V.P.
V1651	SUZUKI	17,14

Interruptor de freno mecánico



Referencia	P.V.P.
E46-50700	5,84
DMX01006	5,84



Referencia	Descripción	P.V.P.
DAT01524	HONDA	
DMC01107	KAWASAKI	
DMC01698	YAMAHA	13,23

XPEED Interruptor de freno hidráulico



Referencia	Descripción	P.V.P.
XT3100	Europa M10x100	9,20
XT3125	Japonesa M10x125	9,20



Referencia	Descripción	P.V.P.
DMC01323	Japonesas M10 x 1,25	8,47
DMC013231	Europeas M10 x 1,00	8,47



Referencia	Descripción	P.V.P.
DMC013282	Japonesas M10 x 1,25	13,04
DMC013283	Europeas M10 x 1,00	13,04

Varios para ITV



Discos de velocidad pequeños 10cm

Referencia	P.V.P.
XT0045	12,98



Catadiópticos

Referencia	Descripción	P.V.P.
XT1030	Adhesivo 75x25mm	2,88
XT1035	Atornillado 75x25mm	2,88
XT1040	Atornillado Ø60mm	2,88



Claxon

Referencia	P.V.P.
XT2040	7,69



XT2010



XT2011

Relé intermitencia

Referencia	Descripción	P.V.P.
XT2010	4x10W - 3 Tomas	12,44
XT2011	4x10W - 2 Tomas	12,44
XT2012	4x21W - 3 Tomas	12,72
XT2013	LEDS 12V 1/100W 2 Tomas	12,65
XT2014	LEDS 12V 1/100W 3 Tomas	13,55

Interruptores



Referencia	Descripción	P.V.P.
DUP01107	Ø 8 mm	



Referencia	Descripción	P.V.P.
DUP011071	Ø 8 mm	



Referencia	Descripción	P.V.P.
DUP01360	Ø 8 mm	5,16



Referencia	Descripción	P.V.P.
XT2050	Warning	14,96



Referencia	Descripción	P.V.P.
D1216604	Ø 8 mm	6,90

RUEDAS Y NEUMÁTICOS

MOTOR

ADMISIÓN / ESCAPE REFRIGERACIÓN

ELÉCTRICO

SUSPENSIÓN / DIRECCIÓN

FRENOS

TRANSMISIÓN

CONTROLES Y MANDOS

CHASIS

ACCESORIOS



BRONCO Regulador de corriente

ARTIC CAT	Año	Referencia	Tipo	Ref. Original	P.V.P.
375 auto	2002	DAT01219	ORIGINAL	3530-028/3530-059/3402-682 (SUZUKI#32800-44D31)	98,63
400 todos	02-08	DAT01219	ORIGINAL	3530-028/3530-059/3402-682 (SUZUKI#32800-44D31)	98,63
400 DVX	04-06	DAT01215	ORIGINAL	3530-028/3530-059/3402-682 (SUZUKI#32800-44D31)	90,75
500 todos	02-09	DAT01219	ORIGINAL	3530-028/3530-059/3402-682 (SUZUKI#32800-44D31)	98,63

CAN AM	Año	Referencia	Tipo	Ref. Original	P.V.P.
Outlander 330	05-10	DAT01657	ORIGINAL	710000908/ 710000261/ 710001103	96,15
Outlander 400	03-15	DAT01657	ORIGINAL	710000908/ 710000261/ 710001103	96,15
Outlander 450	2015	DAT01657	ORIGINAL	710000908/ 710000261/ 710001103	96,15
Outlander 500	08-14	DAT01657	ORIGINAL	710000908/ 710000261/ 710001103	96,15
Renegade 500	08-15	DAT01657	ORIGINAL	710000908/ 710000261/ 710001103	96,15
Outlander 650	08-15	DAT01657	ORIGINAL	710000908/ 710000261/ 710001103	96,15
Outlander 800	08-15	DAT01657	ORIGINAL	710000908/ 710000261/ 710001103	96,15
Renegade 800	08-15	DAT01657	ORIGINAL	710000908/ 710000261/ 710001103	96,15
Outlander 1000	12-14	DAT01657	ORIGINAL	710000908/ 710000261/ 710001103	96,15
Renegade 1000	12-15	DAT01657	ORIGINAL	710000908/ 710000261/ 710001103	96,15

HONDA	Año	Referencia	Tipo	Ref. Original	P.V.P.
TRX 250 EX Sportrax	99-05	DAT01212	ALTO RENDIMIENTO	31600-HM8-013 (00-05)	93,75
TRX 250 Recon	97-06	DAT01212	ALTO RENDIMIENTO	31600-HM8-013 (97-04)	93,75
TRX 300 EX Sportrax	93-06	DAT01213	ALTO RENDIMIENTO	31600-HM3-003, 31600-HM3-901	98,63
TRX 350 Rancher	00-06	DAT01226	ORIGINAL	31600-HN5-671	128,25
TRX 400 EX Sportrax	99-04	DAT01212	ALTO RENDIMIENTO	31600-HM8-013 (99-04),	93,75
TRX 400 EX Sportrax	05-14	DAT01212	ALTO RENDIMIENTO	31600-HN1-A41 (05-09)	93,75
TRX 400 Foreman	95-03	DAT01226	ORIGINAL	31600-HN5-671	128,25
TRX 420 Rancher	07-14	DAT01211	ORIGINAL	31600-HP5-601	90,16
TRX 450 Foreman	98-01	DAT01226	ORIGINAL	31600-HN5-671	128,25
TRX 450 R	04-05	DAT01226	ORIGINAL	31600-HN5-671	128,25
TRX 500 Foreman	05-11	DAT01227	ORIGINAL	31600-HP0-A01	158,24
TRX 500 Rubicon	05-09	DAT01227	ORIGINAL	31600-HP0-A01	158,24
TRX 650 Rincon	03-05	DAT01227	ORIGINAL	31600-HP0-A01	158,24
TRX 680 Rincon	06-14	DAT01227	ORIGINAL	31600-HP0-A01	158,24

E-TON	Año	Referencia	Tipo	Ref. Original	P.V.P.
Lightning 50	00-01	DAT01079	ORIGINAL	N/A	31,32
Viper 50	02-04	DAT01079	ORIGINAL	N/A	31,32
Viper 70 todos	04-07	DAT01079	ORIGINAL	N/A	31,32
Sierra 90	00-05	DAT01079	ORIGINAL	N/A	31,32
Thunder 90	00-01	DAT01079	ORIGINAL	N/A	31,32
Viper 90 todos	02-07	DAT01079	ORIGINAL	N/A	31,32

KAWASAKI	Año	Referencia	Tipo	Ref. Original	P.V.P.
KLF 300 Bayou	98-04	DAT01214	ALTO RENDIMIENTO	21066-1112	68,25
KVF 360 Prairie	03-12	DAT01214	ALTO RENDIMIENTO	21066-1112	68,25
KVF 400 Prairie	99-02	DAT01214	ALTO RENDIMIENTO	21066-1112	68,25
KFX 400	03-07	DAT01215	ALTO RENDIMIENTO	21066-S004, 21066-S011	90,75
KFX 450 R	08-14	DAT01215	ALTO RENDIMIENTO	21066-S004, 21066-S011	90,75
KVF 650 Brute Force	05-13	DAT01214	ALTO RENDIMIENTO	21066-1112	68,25
KVF 650 Prairie	02-03	DAT01214	ALTO RENDIMIENTO	21066-1112	68,25
KFX 700	04-09	DAT01214	ALTO RENDIMIENTO	21066-1112	68,25
KVF 700 Prairie	04-06	DAT01214	ALTO RENDIMIENTO	21066-1112	68,25
KAF 620 Mule 3000	01-08	DSM01118	ORIGINAL	21066-1127	96,15
KAF 620 Mule 3010	01-08	DSM01118	ORIGINAL	21066-1127	96,15
KAF 620 Mule 3020	01-03	DSM01118	ORIGINAL	21066-1127	96,15

KYMCO	Año	Referencia	Tipo	Ref. Original	P.V.P.
Mongoose 250	03-07	DAT01214	ORIGINAL	N/A	68,25
Mongoose 300	06-07	DAT01214	ORIGINAL	N/A	68,25
MXU 150	04-07	DAT01214	ORIGINAL	N/A	68,25
MXU 250	05-07	DAT01214	ORIGINAL	N/A	68,25
MXU 300	06-07	DAT01214	ORIGINAL	N/A	68,25

POLARIS	Año	Referencia	Tipo	Ref. Original	P.V.P.
Outlaw 50	08-15	DAT01079	ORIGINAL	0453479	31,32
Predator 50	04-07	DAT01079	ORIGINAL	0453479	31,32
Scrambler 50	01-03	DAT01079	ORIGINAL	0453479	31,32
Predator 90	03-07	DAT01079	ORIGINAL	0453479	31,32
Scrambler 90	01-03	DAT01079	ORIGINAL	0453479	31,32
Sportsman 90	01-14	DAT01079	ORIGINAL	0453479	31,32
Phoenix 200	04-07	DAT01203	ORIGINAL	0453025	73,80
Trail Blazer 250	90-01	DAT01228	ORIGINAL	4060208	60,75
Xpress 300	96-97	DAT01229	ORIGINAL	4060133	63,75
Magnum 325	98-02	DAT01229	ORIGINAL	4060191	63,75
Sportsman 335	99-00	DAT01229	ORIGINAL	4060191	63,75
Xpedition 325	00-02	DAT01229	ORIGINAL	4060191	63,75
Scrambler 400	95-99	DAT01228	ORIGINAL	4060208	60,75
Sportsman 400	96-97	DAT01229	ORIGINAL	4060133	63,75
Sportsman 400	01-02	DAT01229	ORIGINAL	4060191	63,75
Xplorer 400	96-02	DAT01229	ORIGINAL	4060191	63,75

BRONCO Regulador de corriente

Xpress 400	96-97	DAT01229	ORIGINAL	4060133	63,75
Magnum 425	96-97	DAT01229	ORIGINAL	4060133	63,75
Xpedition 425	00-02	DAT01229	ORIGINAL	4060191	63,75
Magnum 500	99-01	DAT01231	ORIGINAL	4060173 (Supersede: 2203636)	64,05
Scrambler 500	97-02	DAT01231	ORIGINAL	4060173 (Supersede: 2203636)	64,05
Sportsman 500	96-97	DAT01229	ORIGINAL	4060133	63,75
Sportsman 500	00-01	DAT01231	ORIGINAL	4060173 (Supersede: 2203636)	64,05
Worker 500	98-02	DAT01231	ORIGINAL	4060173 (Supersede: 2203636)	64,05
Sportsman 700	02-03	DAT01231	ORIGINAL	4060173 (Supersede: 2203636)	64,05
RZR 800	11-14	DAT01227	ORIGINAL	4012941	

SUZUKI	Año	Referencia	Tipo	Ref. Original	P.V.P.
LT-F 160	91-04	DAT01232	ORIGINAL	32800-19B11	80,55
LT-F 250	88-02	DAT01232	ORIGINAL	32800-19B11	80,55
LT-F 250	02-15	DAT01215	ALTO RENDIMIENTO	32800-05F10/20, Kawasaki 21066-S004, 21066-S011	90,75
LT-Z 250	04-09	DAT01215	ALTO RENDIMIENTO	32800-05F10/20, Kawasaki 21066-S004, 21066-S011	90,75
LT-F 300	99-02	DAT01232	ORIGINAL	32800-19B11	80,55
LT-A 400	02-09	DAT01216		32800-38F10	90,75
LT-Z 400	03-09	DAT01215	ORIGINAL	32800-05F10/20, Kawasaki 21066-S004, 21066-S011	72,25
LT-A 450	07-09	DSM01118	ALTO RENDIMIENTO	32800-42F00	96,15
LT-A 500 King Quad	09-14	DSM01118	ALTO RENDIMIENTO	32800-42F00	96,15
LT-A 500 Vinson	02-09	DSM01118	ALTO RENDIMIENTO	32800-42F00	96,15
LT-A 500 King Quad	98-01	DAT01217	ORIGINAL	32800-33E00	94,05
LT-F 500 Y/K1/K2	98-02	DAT01219	ORIGINAL	32800-44D20/21, 32800-44D30/31	98,63
LT-A 700 King Quad	06-07	DSM01118	ALTO RENDIMIENTO	32800-42F00	96,15
LT-V 700 Twin Peacks	04-05	DAT01214			68,25
LT-A 750 King Quad	08-13	DSM01118	ALTO RENDIMIENTO	32800-42F00	96,15

YAMAHA	Año	Referencia	Tipo	Ref. Original	P.V.P.
YFM 125 Grizzly	04-13	DAT01216	ALTO RENDIMIENTO	5GT-81960-00-00	90,75
YFS 200 Blaster	86-06	D0115432	ORIGINAL	82F-81910-A0-00	28,98
YFM 250 BearTracker	01-04	DAT01216	ALTO RENDIMIENTO	5GT-81960-00-00	90,75
YFM 250 Big Bear	07-09	DAT01216	ALTO RENDIMIENTO	5GT-81960-00-00	90,75
YFM 250 Bruin	05-06	DAT01216	ALTO RENDIMIENTO	5GT-81960-00-00	90,75
YFM 250 Raptor	08-13	DAT01216	ALTO RENDIMIENTO	5GT-81960-00-00	90,75
YFM 350 Big Bear	87-94	DAT01234	ORIGINAL	59V-81960-A0-00	95,55
YFM 350 Bruin	04-06	DAT01216	ALTO RENDIMIENTO	5GT-81960-00-00	90,75
YFM 350 Grizzly	07-14	DAT01216	ALTO RENDIMIENTO	5GT-81960-00-00	90,75
YFM 350 Moto-4	90-94	DAT01234	ORIGINAL	59V-81960-A0-00	95,55
YFM 350 Raptor	04-13	DAT01216	ALTO RENDIMIENTO	5GT-81960-00-00	90,75
YFM 350 Warrior	87-95	DAT01234	ORIGINAL	59V-81960-A0-00	95,55
YFM 350 Wolverine	06-09	DAT01216	ALTO RENDIMIENTO	5GT-81960-00-00	90,75
YFZ 350 Banshee	87-06	D0115432	ORIGINAL	82F-81910-A0-00	28,98
YFM 400 Big Bear	02-12	DAT01216	ALTO RENDIMIENTO	5GT-81960-00-00	90,75
YFM 400 Grizzly	07-08	DAT01216	ALTO RENDIMIENTO	5GT-81960-00-00	90,75
YFM 400 Kodiak	00-06	DAT01216	ALTO RENDIMIENTO	5GT-81960-00-00	90,75
YFM 450 Grizzly	07-14	DSM01118	ALTO RENDIMIENTO	5BN-81960-00-00	96,15
YFM 450 Kodiak	03-06	DAT01216	ALTO RENDIMIENTO	5GT-81960-00-00	90,75
YFM 450 Wolverine	06-09	DAT01216	ALTO RENDIMIENTO	5GT-81960-00-00	90,75
YFZ 450 R	09-16	DSM01118	ALTO RENDIMIENTO	5BN-81960-00-00	96,15
YXR 450 Rhino	06-09	DSM01118	ALTO RENDIMIENTO	5BN-81960-00-00	96,15
YFM 550 Grizzly	09-14	DAT01227	ORIGINAL	1D7-81960-00-00	158,24
YFM 600 Grizzly	99-01	DAT01216	ALTO RENDIMIENTO	5GT-81960-00-00	90,75
YFM 660 Grizzly	02-08	DSM01118	ALTO RENDIMIENTO	5BN-81960-00-00	96,15
YFM 660 Raptor	01-05	DAT01216	ALTO RENDIMIENTO	5GT-81960-00-00	90,75
YXR 660 Rhino	04-07	DSM01118	ALTO RENDIMIENTO	5BN-81960-00-00	96,15
YFM 700 Grizzly	06-14	DAT01227	ORIGINAL	1D7-81960-00-00	158,24
YFM 700 Raptor	06-16	DSM01118	ALTO RENDIMIENTO	5BN-81960-00-00	96,15
YXE 700 Wolverine	2016	DAT01227	ORIGINAL	1D7-81960-00-00	158,24
YXM 700 Viking	14-15	DAT01227	ORIGINAL	1D7-81960-00-00	158,24
YXR 700 Rhino	08-14	DAT01227	ORIGINAL	1D7-81960-00-00	158,24

BRONCO Regulador de corriente universal

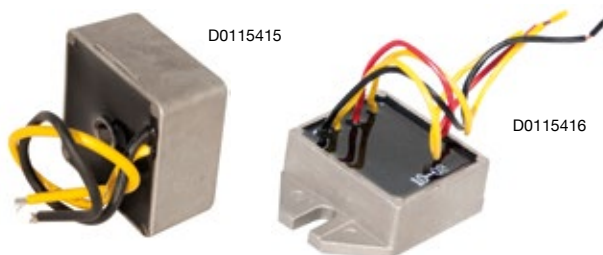

Referencia	Descripción	P.V.P.
D0115415	Regulador 12V	16,32
D0115416	Regulador 12V	23,84

XPEED Testigos luces



Referencia	Descripción	P.V.P.
V1680	Testigo intermitentes	3,50
V1681	Testigo luces cortas	3,50
V1682	Testigo luces largas	3,50

Toma corriente

	Referencia	P.V.P.
Toma Mechero	XSM01085A	8,58
Toma USB	DUP01251	22,50



Faros halógenos

Precio faro por 1 unidad. Faro no homologado.
*Instalación eléctrica con todo el material necesario.

Referencia	Descripción	Diámetro	Largo	P.V.P.
DMP01102	A 35W Negro	45	60	15,05
DMP01102P	A 35W Cromado	45	60	15,05
DMP01103	B 50W Negro	60	65	15,80
DMP01666	C 20W Negro	35	50	10,92
DMP01666P	C 20W Cromado	35	50	10,92
DMC01633	Instalación eléctrica, relé, interruptor			15,70



Limitador velocidad y RPM

Especialmente concebido para alquileres o niños, donde lo que se pretende es limitar la velocidad y revoluciones del vehículo.

Para ofrecer la máxima seguridad al conductor sin perjudicar el funcionamiento del motor, con un mínimo coste y rapidez.



Referencia	P.V.P.
D12474	25,50

BRONCO

Radiador calefacción UTV

Radiador 12V / 300W, 3 posiciones.

Referencia	P.V.P.
DAT12204	60,98



EMGO

Cables batería

Referencia	P.V.P.
E84-96308	8,55



XPEED Retrovisores homologados con brida

La distancia de varilla es desde el codo hasta el espejo.

Referencia	Descripción	P.V.P.
GRU15	Universal varilla 15cm	6,81
*GRD15	Universal derecho varilla 15cm	10,33
*GRI15	Universal izquierdo varilla 15cm	10,33
**GRD07	Plegable derecho	8,75
**GRI07	Plegable izquierdo	8,75



BRONCO Retrovisor UTV

Referencia	Descripción	P.V.P.
DAT12193	Retrovisor central	12,99
DAT12192	Retrovisor central	12,36
DAT12580	Juego de retrovisores laterales	65,20
DAT12581	Retrovisor central	43,43
DAT12582	Juego de retrovisores laterales	65,20



SUSPENSIÓN DIRECCIÓN



SUSPENSIÓN / DIRECCIÓN

XPEED Soporte para manillar

Referencia	Descripción	P.V.P.
R510078	Para manillar de Ø 22 mm	61,05
R510118	Para manillar de Ø 28 mm	61,05



XPEED Columna dirección

P.V.P.
103,25

Con la columna de dirección se precisa montar nuestro soporte de manillar.

HONDA	2 cm	4 cm	6 cm	8 cm
TRX 450R				R5330010
KAWASAKI	2 cm	4 cm	6 cm	8 cm
KFX 400				R5330020
SUZUKI	2 cm	4 cm	6 cm	8 cm
LTZ 400				R5330020
LTR 450				R5330040
YAMAHA	2 cm	4 cm	6 cm	8 cm
YFZ 450	R5330030	R5330030	R5330032	
YFZ 450R	R5330033	R5330034		
YFM 660R Raptor	R5330030	R5330031	R5330032	
YFM 660 Grizzly				R5330030
YFM 700R Raptor	R5330031	R5330032		

BRONCO Kit Reparación dirección

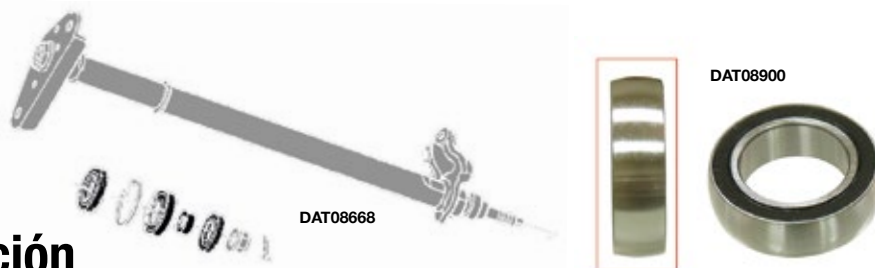

ARTIC CAT	Año	Referencia	Nº Piezas	P.V.P.
400 DVX	03-08	DAT08657		
HONDA	Año	Referencia	Nº Piezas	P.V.P.
TRX 90 Fourtrax	93-12	DAT08656	4	11,64
TRX 200 Fourtrax	90-96	DAT08656	4	11,64
TRX 250 EX Sportrax	01-11	DAT08656	4	11,64
TRX 250 Recon	97-12	DAT08656	4	11,64
TRX 300 EX Sportrax	93-09	DAT08662	3	11,85
TRX 300 Fourtrax	88-00	DAT08663	3	11,85
TRX 350 Rancher	00-06	DAT08663	3	11,85
TRX 400 EX Sportrax	99-09	DAT08656	4	11,64
TRX 400 Foreman/Rancher	95-07	DAT08663	3	11,85
TRX 420 Rancher	07-12	DAT08663	3	11,85
TRX 450 R	04-12	DAT08656	4	11,64
TRX 450 Foreman	98-03	DAT08663	3	11,85
TRX 500 Rubicon	01-12	DAT08665	4	20,59
TRX 650 Rincon	03-05	DAT08665	4	20,59
TRX 680 Rincon	06-12	DAT08665	4	20,59
KAWASAKI	Año	Referencia	Nº Piezas	P.V.P.
KLF 250 Bayou	88-11	DAT08666		35,38
KSF 250 Mojave	04-09	DAT08666		35,38
KLF 300 Bayou	86-04	DAT08666		35,38
KFX 400	03-06	DAT08657	7	15,44
KLF 400 Bayou	93-99	DAT08666		35,38
KVF 400 Prairie	87-04	DAT08666		35,38
KFX 700 V-Force	04-09	DAT08666		35,38
POLARIS	Año	Referencia	Nº Piezas	P.V.P.
550 Sportsman	09-13	DAT08900	1	6,98
850 Sportsman	09-13	DAT08900	1	6,98

SUZUKI	Año	Referencia	Nº Piezas	P.V.P.
LT-A 450 King Quad	07-10	DAT08651		12,61
LT-R 450 Quad Sport	06-09	DAT08651		12,61
LT-A 500 King Quad	09-11	DAT08651		12,61
LT-A 700 King Quad	05-07	DAT08651		12,61
LT-A 750 King Quad	08-13	DAT08651		12,61
YAMAHA	Año	Referencia	Nº Piezas	P.V.P.
YFA1 Breeze	89-04	DAT08668	3	11,85
YFM 125 Grizzly	04-13	DAT08668	3	11,85
YFM 125 Raptor	11-12	DAT08668	3	11,85
YFS 200 Blaster	88-06	DAT08668	3	11,85
YFM 250 Raptor	08-12	DAT08668	3	11,85
YFM 350 Warrior	87-04	DAT08668	3	11,85
YFM 350 Raptor	04-13	DAT08668	3	11,85
YFZ 350 Banshee	91-06	DAT08668	3	11,85
YFM 350 Grizzly	07-14	DAT08668	3	11,85
YFZ 450	04-13	DAT08668	3	11,85
YFZ 450 R	09-16	DAT08668	3	11,85
YFM 450 Kodiak	04-06	DAT08668	3	11,85
YFM 450 Grizzly	07-12	DAT08668	3	11,85
YFM 550 Grizzly	09-13	DAT08668	3	11,85
YFM 660 Raptor	01-05	DAT08668	3	11,85
YFM 660 Grizzly	02-08	DAT08668	3	11,85
YFM 700 Raptor	06-13	DAT08668	3	11,85
YFM 700 Grizzly	07-14	DAT08668	3	11,85

BRONCO Kit Reparación basculante

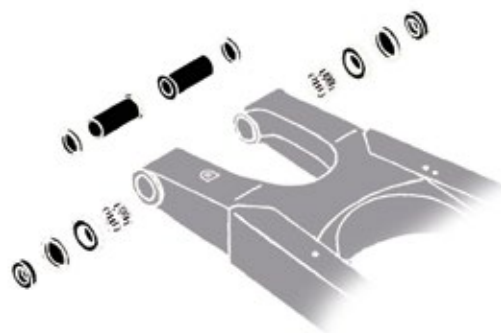

RUEDAS Y NEUMÁTICOS

MOTOR

ADMISIÓN / ESCAPE
REFRIGERACIÓN

ELECTRICO

SUSPENSIÓN / DIRECCIÓN

FRENOS

TRANSMISIÓN

CONTROLES Y MANDOS

CHASIS

ACCESORIOS

ARTIC CAT	Año	Referencia	Nº Piezas	P.V.P.
400 DVX	03-08	DAT04303		53,42

HONDA	Año	Referencia	Nº Piezas	P.V.P.
TRX 250 EX Sportrax	01-11	DAT04338		29,44
TRX 250 Recon	97-12	DAT04338		29,44
TRX 400 EX Sportrax	99-09	DAT04116	10	40,08
TRX 420 Rancher	07-12	DAT04318		40,80
TRX 450 R	04-12	DAT04305	12	37,28

KAWASAKI	Año	Referencia	Nº Piezas	P.V.P.
KVF 300 Prairie	99-02	DAT04307	12	38,68
KVF 360 Prairie	03-12	DAT04307	12	38,68
KFX 400	03-06	DAT04303		53,42
KVF 400 Prairie	98-02	DAT04307	12	38,68
KFX 450 R	08-11	DAT04306		56,30
KVF 650 Prairie	02-03	DAT04307	12	38,68
KVF 650 Brute Force	05-11	DAT04307	12	38,68
KVF 650i Brute Force	06-12	DAT04307	12	38,68
KVF 700 Prairie	04-06	DAT04307	12	38,68
KFX 700 V-Force	04-09	DAT04307	12	38,68

SUZUKI	Año	Referencia	Nº Piezas	P.V.P.
LT-R 250 Quadracracer	87-92	DAT04308	14	47,92
LT-Z 400 QuadSport	03-12	DAT04303	14	53,42
LT-R 450	06-09	DAT04309	18	64,51
LT-R 500 Quadracracer	87-90	DAT04308	14	47,92
LT-V 700 Twin Peaks	04-05	DAT04307	12	38,68

YAMAHA	Año	Referencia	Nº Piezas	P.V.P.
YFS 200 Blaster	88-06	DAT04300		45,14
YFM 350 Warrior	87-04	DAT04312	7	42,43
YFM 350 Raptor	04-13	DAT04312	7	42,43
YFZ 350 Banshee	91-06	DAT04301		42,06
YFZ 450	04-13	DAT04314	14	49,76
YFZ 450 R	09-15	DAT04328		38,95
YFM 660 Raptor	01-05	DAT04315	18	43,24
YFM 700 Raptor	06-15	DAT04316	14	47,26

BRONCO

Kit soporte columna dirección

No dejes que tu Yamaha tenga holgura en la dirección, aquí tienes este kit, a un mínimo coste.

Referencia	P.V.P.
DAT08655	10,50



BRONCO Kit Reparación bieleta

ARTIC CAT	Año	Referencia	Nº Piezas	P.V.P.
400 DVX	03-08	DAT04118	25	78,88

KAWASAKI	Año	Referencia	Nº Piezas	P.V.P.
KFX 400	03-06	DAT04118	25	78,88

SUZUKI	Año	Referencia	Nº Piezas	P.V.P.
LT-Z 400 QuadSport	03-12	DAT04118	25	78,88
LT-R 450	06-09	DAT04119	25	71,60

YAMAHA	Año	Referencia	Nº Piezas	P.V.P.
YFM 350 Raptor	04-13	DAT04341	20	30,12
YFM 350 Warrior	87-04	DAT04342	22	45,12
YFZ 350 Banshee	87-06	DAT04342	22	45,12
YFZ 450	04-13	DAT04343	18	51,12
YFZ 450 R	09-15	DAT04345	17	52,20
YFM 660 Raptor	01-05	DAT04346	22	45,36
YFM 700 Raptor	06-15	DAT04347	16	33,45

SUSPENSIÓN / DIRECCIÓN

P.V.P
16

P.V.P
19

P.V.P
26



4PLAY Rotulas dirección

ARTIC CAT	Año	Interior	Exterior
250 DVX	06-08	DAT081251	DAT08125
300 DVX	09-11	DAT081251	DAT08125
400 DVX	04-08	DAT081251	DAT08125
Resto ATV	00-11	DAT08136	DAT08564
1000 Wildcat	13-14	DAT08750L	DAT08751R

CAN AM	Año	Interior	Exterior
330 Outlander	04-05	DAT08568L	DAT08122
400 Outlander	03-14	DAT08568L	DAT08122
500 Renegade	08-12	DAT08568L	DAT08122
500 Renegade	13-14	DAT08561L	DAT08760
500 Outlander	07-12	DAT08568L	DAT08122
500 Outlander	13-14	DAT08561L	DAT08760
500 Traxter	99-05	DAT08760	DAT08761L
650 DS	00-07	DAT08760	DAT08761L
650 Outlander	07-12	DAT08568L	DAT08122
650 Outlander	13-14	DAT08760	DAT08761L
650 Quest	02-04	DAT08760	DAT08761L
650 Traxter	04-05	DAT08760	DAT08761L
800 Commander	11-12	DAT08568L	DAT08122
800 Renegade	07-12	DAT08568L	DAT08122
800 Renegade	12-14	DAT08760	DAT08761L
800 Outlander	06-12	DAT08568L	DAT08122
800 Outlander	12-14	DAT08760	DAT08761L
1000 Commander	11-12	DAT08568L	DAT08122
1000 Maverick	13-15	DAT08561	DAT08561
1000 Renegade	2012	DAT08568L	DAT08122
1000 Renegade	12-14	DAT08760	DAT08761L
1000 Outlander	2012	DAT08568L	DAT08122
1000 Outlander	12-15	DAT08760	DAT08761L

HONDA	Año	Interior	Exterior
TRX 90	93-14	DAT08562	DAT08121
TRX 250 EX Sportrax	01-14	DAT08123	DAT08122
TRX 250 Recon	97-14	DAT08123	DAT08122
TRX 300 Sportrax	93-08	DAT08567	DAT08124
TRX 300 Fourtrax	88-00	DAT08123	DAT08122
TRX 350 Rancher	00-06	DAT08123	DAT08122
TRX 400 Sportrax	99-14	DAT08567	DAT08124
TRX 400 Foreman	95-03	DAT08123	DAT08122
TRX 400 Rancher	04-06	DAT08123	DAT08122
TRX 420 Rancher	07-14	DAT08123	DAT08122
TRX 450 R Sportrax	04-14	DAT08567	DAT08124
TRX 450 Foreman	98-04	DAT08123	DAT08122
TRX 500 Rubicon	01-12	DAT08123	DAT08122
TRX 500 Foreman	05-12	DAT08123	DAT08122
TRX 650 Rincon	03-05	DAT08123	DAT08122
TRX 680 Rincon	06-13	DAT08123	DAT08122

KAWASAKI	Año	Interior	Exterior
KSF 80 KFX	03-06	DAT08126	DAT08136
KLF 220 Bayou	88-02	DAT08126	DAT08136
KLF 250 Bayou	03-11	DAT08126	DAT08136
KSF 250 Mojave	87-04	DAT08126	DAT08136
KEF 300 Lakota	95-03	DAT08126	DAT08136
KLF 300 Bayou	88-04	DAT08126	DAT08136
KVF 300 Brute Force	12-14	DAT08125	DAT081251
KVF 300 Prairie	99-02	DAT08126	DAT08563
KVF 360 Prairie	03-13	DAT08568L	DAT08122
KFX 400	2003	DAT08126	DAT08136

KFX 400	04-06	DAT081251	DAT08125
KLF 400 Bayou	93-99	DAT08126	DAT08136
KVF 400 Prairie	98-02	DAT08126	DAT08563
KFX 450 R	08-14	DAT08566	DAT08565
KVF 650 Prairie	02-03	DAT08124	DAT08563
KVF 650 Brute Force	05-12	DAT08564	DAT08563
KVF 650 i Brute Force	06-13	DAT08124	DAT08567
KVF 700 Prairie	04-06	DAT08564	DAT08563
KVF 750 i Brute Force	05-14	DAT08124	DAT08567

POLARIS	Año	Interior	Exterior
200 Phoenix	06-09	DAT08136	DAT08126
250 Trail Blazer	90-94		DAT08129
250 Trail Blazer	1996	DAT08128	DAT08129
250 Trail Blazer	97-06	DAT08131	DAT08129A
250 Trail Boss	88-99	DAT08128	DAT08127
250 Xplorer	00-02	DAT08131	DAT08129A
300 Hawkeye	06-11	DAT08758	DAT08759
300 Sportsman	08-10	DAT08758	DAT08759
300 Xplorer	96-97	DAT08128	DAT08129
300 Xplorer	98-99	DAT08131	DAT08129A
300 Xpress	96-97	DAT08128	DAT08127
300 Xpress	98-99	DAT08131	DAT08129A
325 Magnum	00-02	DAT08131	DAT08129A
325 Xpedition	00-02	DAT08131	DAT08129A
325 Trail Boss	00-02	DAT08131	DAT08129A
330 Trail Boss	06-10	DAT08131	DAT08129A
330 Magnum	03-06	DAT08131	DAT08129A
330 Trail Blazer	08-13	DAT08131	DAT08129A
335 Sportsman	1999	DAT08131	DAT08129A
350 Trail Boss	90-93	DAT08128	DAT08127
400 Hawkeye	12-14	DAT08131	DAT08129A
400 Scrambler	95-96	DAT08128	DAT08129
400 Scrambler	97-02	DAT08131	DAT08129A
400 Sportsman	93-94	DAT08128	DAT08127
400 Sportsman	95-97	DAT08128	DAT08129
400 Sportsman	01-05	DAT08131	DAT08129A
400 Sportsman	08-10	DAT08758	DAT08759
400 Sportsman	11-14	DAT08131	DAT08129A
400 Sport	95-96	DAT08128	DAT08129
400 Sport	97-99	DAT08131	DAT08129A
400 Trail Boss	1994	DAT08128	DAT08127
400 Trail Blazer	2003	DAT08131	DAT08129A
400 Xpedition	2000	DAT08129A	
400 Xplorer	95-97	DAT08128	DAT08129
400 Xplorer	98-02	DAT08131	DAT08129A
425 Magnum	95-97	DAT08128	DAT08129
425 Magnum	1998	DAT08131	DAT08129A
425 Xpedition	00-02	DAT08131	DAT08129
450 Outlaw	2008	DAT08574L	DAT08574R
450 Outlaw	09-10	DAT08569L	DAT08569R
450 Sportman	06-07	DAT08131	DAT08129A
500 ATP	04-05	DAT08131	DAT08129A
500 Big Boss 6x6	98-99	DAT08131	DAT08129A
500 Magnum	99-03	DAT08131	DAT08129A
500 Predator	03-06	DAT08574R	DAT08574L
500 Scrambler	97-12	DAT08131	DAT08129A
500 Sportsman	1996	DAT08128	DAT08129
500 Sportsman	1997	DAT08128	
500 Sportsman	98-13	DAT08131	DAT08129A
500 Xplorer	1997	DAT08128	DAT08129

Especificaciones:

R: Rosca derecha
L: Rosca izquierda

Referencia	P.V.P.
DAT08121	R
DAT08122	R
DAT08123	L
DAT08124	R
DAT08125	R
DAT081251	L
DAT08126	R
DAT08127	L
DAT08128	R
DAT08129	L
DAT08129A	L
DAT08130	L
DAT08131	R
DAT08136	L
DAT08557	R
DAT08558	R
DAT08558	R
DAT08559	L
DAT08559	L
DAT08560	L
DAT08561	R
DAT08562	L
DAT08563	L
DAT08564	R
DAT08564	R
DAT08565	R
DAT08566	L
DAT08567	L
DAT08568L	L
DAT08569L	L
DAT08569R	R
DAT08574L	L
DAT08574R	R
DAT08574R	R
DAT08575L	L
DAT08575R	R
DAT08750	L
DAT08751	R
DAT08752	L
DAT08758	R
DAT08759	L
DAT08760	L
DAT08761	R
DAT08762	R
DAT08765	L
DAT08766	L

P.V.P
16

P.V.P
19

P.V.P
26

4PLAY Rotulas dirección



525 Outlaw	09-10	DAT08569L	DAT08569R
550 Sportsman	2009	DAT08569L	DAT08569R
550 Sportsman	10-11	DAT08563	DAT08126
570 Sportsman	2014	DAT08131	DAT08129A
600 Sportsman	03-05	DAT08131	DAT08129A
700 Sportsman	02-08	DAT08131	DAT08129A
800 Sportsman	05-14	DAT08131	DAT08129A
800 RZR	08-14		DAT08129A
800 RZR "S"	09-14		DAT08129A
800 RZR "4"	10-14		DAT08129A
850 Sportsman	2009	DAT08569R	DAT08569L
850 Sportsman	10-14	DAT08563	DAT08126
900 RZR XP	11-14		DAT08129A
900 RZR XP "4"	12-14		DAT08129A
1000 RZR XP	2014		DAT08752
1000 RZR XP	2015		DAT08765
1000 RZR XP "4"	2014		DAT08752
425/500/550/700 Ranger	todos		DAT08129A

SUZUKI	Año	Interior	Exterior
LT 80	87-06	DAT08126	DAT08136
LT-F 160	89-04	DAT08562	DAT08121
LT 250 R	90-92	DAT08136	DAT08126
LT-Z 250	04-08	DAT08125	DAT081251
LT-F 250 Quadrunner	88-02	DAT08136	DAT08126
LT-F 250 Ozark	02-03	DAT08136	DAT08126
LT-F 250 Ozark	04-12	DAT081251	DAT08125
LT-Z 400	2003	DAT08136	DAT08126
LT-Z 400	04-08	DAT08125	DAT081251
LT-Z 400	09-13	DAT08566	DAT08565
LT-A 400 Eiger	02-04	DAT08136	DAT08126
LT-A 400 Eiger	05-07	DAT081251	DAT08125
LT-F 400 Eiger	02-04	DAT08136	DAT08126
LT-F 400 Eiger	05-07	DAT081251	DAT08125
LT-A 400 King Quad	08-11	DAT081251	DAT08125
LT-F 400 King Quad	08-11	DAT081251	DAT08125
LT-R 450	06-11	DAT08566	DAT08565
LT-A 450 King Quad	07-10	DAT08575L	DAT08575R
LT-A 500 Vinson	02-03	DAT08136	DAT08126
LT-A 500 Vinson	04-07	DAT081251	DAT08125
LT-F 500 Vinson	2003	DAT08136	DAT08126
LT-F 500 Vinson	04-07	DAT081251	DAT08125
LT-A 500 King Quad	09-10	DAT08566	DAT08565
LT-A 500 King Quad	11-13	DAT08575L	DAT08575R

LT-V 700 Twin Peaks	04-06	DAT08563	
LT-A 700 King Quad	05-07	DAT08575L	DAT08575R
LT-A 750 King Quad	08-13	DAT08575L	DAT08575R

YAMAHA	Año	Interior	Exterior
YFA 1 Brezee	89-04	DAT08125	DAT081251
YFM 125 Grizzly	04-13	DAT08125	DAT081251
YFM 125 Raptor	11-13	DAT08125	DAT081251
YFS 200 Blaster	88-06	DAT08125	DAT081251
YFM 250 Raptor	08-13	DAT08125	DAT081251
YFB 250 Timberwolf	92-98	DAT08125	DAT081251
YFM 250 Bear Tracker	99-04	DAT08558	DAT08559
YFM 250 Big Bear	07-09	DAT08558	DAT08559
YFM 250 Bruin	05-06	DAT08558	DAT08559
YFM 350 Warrior	88-04	DAT08125	DAT081251
YFM 350 Raptor	04-12	DAT08125	DAT081251
YFZ 350 Banshee	87-06	DAT08125	DAT081251
YFM 350 Wolverine semi.	95-05	DAT08125	DAT081251
YFM 350 Wolverine auto.	06-09	DAT08558	DAT08559
YFM 350 Big Bear	87-99		DAT08130
YFM 350 Bruin	04-06	DAT08558	DAT08560
YFM 350 Grizzly	07-12	DAT08558	DAT08559
YFM 350 Grizzly	13-15	DAT08125	DAT081251
YFM 400 Big Bear semi.	00-06	DAT08558	DAT08559
YFM 400 Big Bear auto.	07-13	DAT08558	DAT08559
YFM 400 Kodiak Semi.	93-02	DAT08125	DAT081251
YFM 400 Kodiak auto.	00-01	DAT08125	DAT081251
YFM 400 Kodiak auto.	02-04		DAT08130
YFM 400 Kodiak auto.	05-06	DAT08558	DAT08130
YFM 400 Grizzly	07-10	DAT08558	DAT08560
YFM 450 Grizzly	07-12	DAT08558	DAT08560
YFM 450 Grizzly	13-15	DAT08125	DAT081251
YFM 450 Kodiak	04-06	DAT08558	DAT08560
YFM 450 Wolverine	2006	DAT08558	DAT08560
YFM 450 Wolverine	07-11	DAT08558	DAT08559
YFZ 450	04-05	DAT08125	DAT081251
YFZ 450	06-13	DAT08565	DAT08566
YFZ 450 R	09-15	DAT08565	DAT08566
YFM 550 Grizzly	09-15	DAT08125	DAT081251
YFM 600 Grizzly	98-01	DAT08125	DAT081251
YFM 660 Raptor	01-05	DAT08125	DAT081251
YFM 660 Grizzly	02-08	DAT08125	DAT081251
YFM 700 Raptor	06-15	DAT08565	DAT08566
YFM 700 Grizzly	07-15	DAT08125	DAT081251
YXM 700 Viking	14-16	DAT08762	DAT08766

4PLAY Rotulas barra estabilizadora

YAMAHA	Año	Izquierda	Derecha
YFM 350 Grizzly IRS	10-11	DAT08766	DAT08762
YFM 400 Big Bear	10-11	DAT08766	DAT08762
YFM 450 Grizzly	10-14	DAT08766	DAT08762
YFM 550 Grizzly	10-14	DAT08766	DAT08762
YFM 700 Grizzly	10-14	DAT08766	DAT08762
YXR 700 Viking	14-15	DAT08766	DAT08762



RUEDAS Y NEUMÁTICOS

MOTOR

ADMISIÓN / ESCAPE
REFRIGERACIÓN

ELECTRICO

SUSPENSIÓN / DIRECCIÓN

FRENOS

TRANSMISIÓN

CONTROLES Y MANDOS

CHASIS

ACCESORIOS

P.V.P
19

P.V.P
23

P.V.P
27

4PLAY Rotulas trapecios

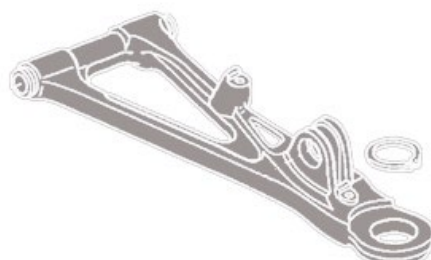

ARTIC CAT	Año	Inferior	Superior
400 DVX	04-08		DAT08581
1000 XT	13-14	DAT08581	DAT08581
1000 Wildcat "4"	13-14	DAT08816	DAT08816
1000 Wildcat "X"	13-14	DAT08816	DAT08816
Resto de modelos	02-14	DAT08580	DAT08580

CAN AM	Año	Inferior	Superior
330 Outlander	04-05		DAT08806
400 Outlander	03-05		DAT08806
400 Outlander	06-14	DAT08812	DAT08806
500 Quest	02-03	DAT08810	DAT08810
500 Outlander	07-12	DAT08812	DAT08806
500 Outlander	13-14	DAT08818	DAT08819
500 Renegade	08-12	DAT08810	DAT08810
500 Renegade	13-14	DAT08818	DAT08819
500 Traxter	00-05	DAT08810	DAT08810
650 Outlander	06-12	DAT08812	DAT08810
650 Outlander	13-14	DAT08818	DAT08819
650 Traxter	04-05	DAT08810	DAT08810
650 Quest	02-04	DAT08810	DAT08810
800 Comander	11-13	DAT08818	DAT08819
Renegade 800	07-11	DAT08810	DAT08810
Renegade 800	12-14	DAT08818	DAT08819
Outlander 800	06-12	DAT08812	DAT08810
Outlander XT 800 R	2012	DAT08818	DAT08819
Outlander 800	13-14	DAT08818	DAT08819
Comander 1000	12-13	DAT08818	DAT08819
Renegade 1000	12-14	DAT08818	DAT08819
Outlander 1000	12-14	DAT08818	DAT08819
Maverick 1000	13-15	DAT08818	DAT08819

HONDA	Año	Inferior	Superior
TRX 250 Recon	97-14	DAT08553	DAT04023
TRX 250 Sportrax	01-14		DAT04023
TRX 300 Fourtrax	88-00	DAT04023	DAT04023
TRX 350 Rancher	00-06	DAT04023	DAT04024
TRX 400 Fourtrax	95-03	DAT04023	DAT04023
TRX 400 Fourtrax	04-07	DAT04023	DAT04024
TRX 420 Rancher	07-14	DAT04023	DAT04024
TRX 450 Fourtrax	98-04	DAT04024	DAT04024
TRX 500 Rubicon	01-10	DAT04024	DAT04024
TRX 500 Foreman	05-14	DAT04024	DAT04024
TRX 650 Rincon	03-05	DAT04024	DAT04024
TRX 680 Rincon	06-14	DAT04024	DAT04024

KAWASAKI	Año	Inferior	Superior
KFX 250 Tecate	87-88	DAT08599	DAT08576
KFX 250 Mojave	87-04	DAT08599	DAT08576
KEF 300 Lakota	95-03		DAT08576
KLF 300 C Bayou	89-04	DAT08599	DAT08576
KVF 300 Prairie	99-00		DAT08806
KVF 300 Prairie	01-02	DAT08805	DAT08806
KVF 360 Prairie	03-13	DAT08582	DAT08806
KFX 400	2003		DAT08582
KFX 400	04-06		DAT08581
KLF 400 Bayou	93-99	DAT08599	DAT08576
KVF 400 Prairie	98-00	DAT08599	DAT08806

KVF 400 Prairie	01-02	DAT08805	DAT08806
KFX 450 R	08-14	DAT08582	DAT08582
KVF 650 Pairie	02-03	DAT08582	DAT08806
KVF 650 Brute Force	05-12	DAT08582	DAT08806
KVF 650 i Brute Force	06-13	DAT08582	DAT08582
KFX 700 V-Force	04-09	DAT08582	DAT08582
KVF 700 Prairie	04-06	DAT08582	DAT08806
KVF 750i Brute Force	05-14	DAT08582	DAT08582
750 Teryx	08-13	DAT08582	DAT08582

POLARIS	Año	Inferior	Superior
200 Phoenix	05-13	DAT08802	DAT08802
200 Sawtooth	2007	DAT08802	DAT08802
250 Trail Blazer	90-06	DAT08554	
250 Trail Boss	88-99	DAT08554	
250 Xplorer	00-02	DAT08554	
300 Hawkeye	06-11	DAT08807	
300 Trail Boss	1995	DAT08554	
300 Sportsman	08-10	DAT08807	
325 Magnum	01-02	DAT08554	
325 Xpedition	00-02	DAT08554	
325 Trail Boss	00-02	DAT08554	
330 Magnum	03-05	DAT08554	
330 Trail Blazer	08-13	DAT08554	
330 Trail Boss	03-13	DAT08554	
400 Trail Blazer	2003	DAT08554	
400 Scrambler	95-02	DAT08554	
400 Sport	94-99	DAT08554	
400 Sportsman	94-14	DAT08554	
450 Outlaw	08-10	DAT08803	DAT08803
450 Sportsman	06-07	DAT08554	
500 Outlaw	06-07	DAT08803	DAT08803
500 Predator	03-06	DAT08802	DAT08802
500 Predator	2007	DAT08803	DAT08803
500 Magnum	99-03	DAT08554	
500 Ranger	99-14	DAT08554	
500 Scrambler	97-12	DAT08554	
500 ATP	04-05	DAT08554	
500 Sportsman	96-13	DAT08554	
525 Outlaw	07-11	DAT08803	DAT08803
550 Sportsman	09-14	DAT08807	DAT08807
570 RZR	12-15	DAT08807	DAT08807
600 Sportsman	03-05	DAT08554	
700 Sportsman	02-08	DAT08554	
700 Ranger	05-09	DAT08554	
700 Ranger	2009	DAT08807	DAT08807
800 Sportsman	05-13	DAT08554	
800 Ranger	10-14	DAT08807	DAT08807
800 RZR	08-14	DAT08807	DAT08807
800 RZR "S"	09-14	DAT08807	DAT08807
800 RZR "4"	10-14	DAT08807	DAT08807
850 Sportsman	09-14	DAT08807	DAT08807
900 RZR XP	2011	DAT08807	DAT08807
900 RZR XP	12-14	DAT08813	DAT08813
1000 RZR XP	14-15	DAT08577	DAT08577
1000 RZR XP "4"	14-15	DAT08577	DAT08577

P.V.P
19

P.V.P
23

P.V.P
27

4PLAY Rotulas trapecios



SUZUKI	Año	Inferior	Superior
LT-Z 250 Quad Sport	04-09	DAT08801	DAT08801
LT-F 250 (Excluido Ozark)	89-02	DAT08556	DAT08556
LT-F 250 Ozark	05-12		DAT08581
LT-F 300 King Quad	99-02	DAT08556	DAT08556
LT-Z 400	03-04		DAT08582
LT-Z 400	05-12		DAT08581
LT-A 400 Eiger	02-07	DAT08350	DAT08350
LT-F 400 Eiger	02-08	DAT08350	DAT08350
LT-A 450 King Quad	07-10	DAT08581	DAT08581
LT-A 500 Quad Master	00-01	DAT08556	
LT-F 500 Quad Master	00-01	DAT08556	
LT-F 500 Quad Runner	98-99	DAT08556	
LT-A 500 Vinson	02-07	DAT08350	DAT08350
LT-F 500 Vinson	02-07	DAT08350	DAT08350
LT-A 500 King Quad	09-11	DAT08581	DAT08581
LT-V 700 Twin Peaks	04-06		DAT08806
LT-A 700 King Quad	05-07	DAT08581	DAT08581
LT-A 750 King Quad	08-13	DAT08581	DAT08581

YAMAHA	Año	Inferior	Superior
YFB 250 Timberwolf	92-98		DAT08806
YFM 250 Bear Tracker	99-04	DAT08823	DAT08806
YFM 250 Big Bear	07-09	DAT08823	DAT08806
YFM 250 Bruin	05-06	DAT08823	DAT08806
YFM 350 Bruin	04-06	DAT04023	DAT04023
YFM 350 Grizzly	07-16	DAT04023	DAT04023
YFM 350 Grizzly IRS	07-11	DAT04023	DAT04023
YFM 350 Wolverine auto.	06-09	DAT04023	DAT04023
YFM 400 Big Bear	00-06	DAT04023	DAT04023
YFM 400 Big Bear IRS	07-12	DAT04023	DAT04023
YFM 400 Grizzly IRS	07-09	DAT04023	DAT04023
YFM 400 Kodiak	03-06	DAT04023	DAT04023
YFM 450 Grizzly	07-16	DAT04023	DAT04023
YFM 450 Kodiak	03-06	DAT04023	DAT04023
YFM 450 Wolverine	06-10	DAT04023	DAT04023
YFZ 450	04-13	DAT08801	
YFZ 450 R	09-16	DAT08801	
YXR 450 Rhino	06-09	DAT04023	DAT04023
YFM 550 Grizzly	09-15	DAT08800	DAT08801
YFM 600 Grizzly	98-01		DAT08806
YFM 660 Raptor	01-05	DAT08801	
YFM 660 Grizzly	02-08	DAT08809	
YXR 660 Rhino	04-07	DAT04023	DAT04023
YFM 700 Raptor	06-16	DAT08801	
YFM 700 Grizzly	07-15	DAT08800	DAT08801
YXR 700 Rhino	08-13	DAT04023	DAT04023
YXM 700 Viking	14-16	DAT08821	



RUEDAS Y NEUMÁTICOS

MOTOR

ADMISIÓN / ESCAPE
REFRIGERACIÓN

ELECTRICO

SUSPENSIÓN / DIRECCIÓN

FRENOS

TRANSMISIÓN

CONTROLES Y MANDOS

CHASIS

ACCESORIOS

SUSPENSIÓN / DIRECCIÓN

4PLAY Kit casquillos trapecios delanteros

Consta de todo el material necesario para la reconstrucción completa de un trapecio.

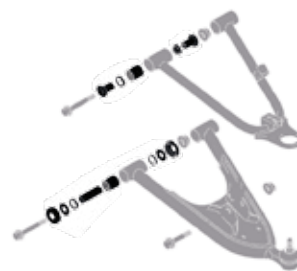

ARTIC CAT	TRAPECIO SUPERIOR			TRAPECIO INFERIOR	
	Año	Referencia	P.V.P.	Referencia	P.V.P.
400 DVX	04-07	DAT04120	36,40	DAT041201	34,72
400 a 1000 todos atv	10-14	DAT045031	5,25	DAT045021	6,30

CAN AM	TRAPECIO SUPERIOR			TRAPECIO INFERIOR	
	Año	Referencia	P.V.P.	Referencia	P.V.P.
330 Outlander	04-05			DAT04348	14,47
400 Outlander	03-15			DAT04348	14,47
450 DS	08-12	DAT04348	14,47	DAT04348	14,47
450 Outlander	2015	DAT04348	14,47	DAT04348	14,47
500 Outlander	07-15			DAT04348	14,47
500 Quest	02-03			DAT04348	14,47
500 Renegade	08-12	DAT04348	14,47	DAT04348	14,47
500 Traxter	01-05	DAT04348	14,47	DAT04348	14,47
650 Outlander	07-15	DAT04348	14,47	DAT04348	14,47
650 Quest	02-04	DAT04348	14,47	DAT04348	14,47
650 Traxter	04-05	DAT04348	14,47	DAT04348	14,47
800 Commander	11-12			DAT04348	14,47
800 Outlander	06-12	DAT04348	14,47	DAT04348	14,47
800 Renegade	07-12	DAT04348	14,47	DAT04348	14,47
1000 Commander	11-15			DAT04348	14,47
1000 Outlander	2012	DAT04348	14,47	DAT04348	14,47
1000 Renegade	2012	DAT04348	14,47	DAT04348	14,47

HONDA	TRAPECIO SUPERIOR			TRAPECIO INFERIOR	
	Año	Referencia	P.V.P.	Referencia	P.V.P.
TRX 90	93-13			DAT04134	29,45
TRX 200	90-97	DAT04134	29,45	DAT04134	29,45
TRX 250 Recon	97-13	DAT04134	29,45	DAT04134	29,45
TRX 250R	87-92	DAT04122	32,11	DAT04122	32,11
TRX 250 Sportrax	01-11	DAT04134	29,45	DAT04134	29,45
TRX 300 Sportrax	93-08	DAT04122	32,11	DAT04122	32,11
TRX 300 Fourtrax 4x4	88-00	DAT04134	29,45	DAT04134	29,45
TRX 350 Rancher	00-06	DAT04134	29,45	DAT04134	29,45
TRX 400 Sportrax	99-07	DAT04122	32,11	DAT04122	32,11
TRX 400 Rancher	95-06	DAT04134	29,45	DAT04134	29,45
TRX 420 Rancher	07-14	DAT04134	29,45	DAT04134	29,45
TRX 450R Sportrax	04-08	DAT04122	32,11	DAT04122	32,11
TRX 450 Foreman	98-04	DAT04134	29,45	DAT04134	29,45
TRX 500 Fourtrax 4x4	01-08	DAT04123	21,37	DAT04134	29,45
TRX 500 Rancher 4x4	09-14	DAT04123	21,37	DAT04134	29,45
TRX 650 Rincon 4x4	03-05	DAT04124	21,48	DAT04134	29,45
TRX 680 Rincon 4x4	06-14	DAT04124	21,48	DAT04134	29,45
TRX 700 XX	08-09	DAT04122	32,11	DAT04122	32,11

KAWASAKI	TRAPECIO SUPERIOR			TRAPECIO INFERIOR	
	Año	Referencia	P.V.P.	Referencia	P.V.P.
KSF 250 Mojave	87-04	DAT04125	40,43	DAT04125	40,43
KXF 250 Tecate	1987	DAT04125	40,43	DAT04125	40,43
KEF 300 Lakota	95-03	DAT04125	40,43	DAT04125	40,43
KLF 300 Bayou	88-04	DAT04121	31,30	DAT04121	31,30
KLF 300 Prairie	99-02			DAT04121	31,30
KLF 360 Prairie	03-12			DAT04121	31,30
KLF 400 Bayou	89-04	DAT04121	31,30	DAT04121	31,30
KLF 400 Prairie	98-02			DAT04121	31,30
KFX 400	03-06	DAT04120	36,40	DAT041201	34,72
KFX 450R	08-14	DAT04127	35,00		
KVF 650 Prairie	02-03			DAT04126	49,78
KVF 650 Brute Force	05-09			DAT04126	49,78
KVF 650 i Brute Force	06-13	DAT04135	38,35	DAT04127	35,00
KVF 700 Prairie	04-06			DAT04126	49,78
KFX 700 V-Force	04-09	DAT04127	35,00	DAT04127	35,00
KVF 750 Brute Force	05-12	DAT04135	38,35	DAT04127	35,00
KRF 750 Tryx	08-13	DAT04500	49,67	DAT04500	49,67

POLARIS

POLARIS: MÁS INFORMACIÓN SIGUIENTE PÁGINA

SUZUKI	TRAPECIO SUPERIOR			TRAPECIO INFERIOR	
	Año	Referencia	P.V.P.	Referencia	P.V.P.
LT-Z 250	04-08	DAT04128	30,38	DAT04128	30,38
LT-F 250 Quad Runner	89-02	DAT04128	30,38	DAT04128	30,38
LT-F 250 Ozark	02-12	DAT04128	30,38	DAT04128	30,38
LT-F 300 King Quad	97-02	DAT04128	30,38	DAT04128	30,38
LT-Z 400	03-12	DAT04120	39,92	DAT041201	34,72
LT-A 400 Eiger	02-07	DAT04128	30,38	DAT04128	30,38
LT-F 400 Eiger	02-07	DAT04128	30,38	DAT04128	30,38
LT-A 400 King Quad	08-11	DAT04128	30,38	DAT04128	30,38
LT-A 450 King Quad	07-10	DAT04329	27,84	DAT04128	30,38
LT-A 500 King Quad	09-11	DAT04332		DAT04334	
LT-F 500 Quad Runner	98-02	DAT04128	30,38	DAT04128	30,38
LT-A 500 Vinson	02-07	DAT04128	30,38	DAT04128	30,38
LT-A 500 King Quad	09-15	DAT04329	27,84		
LT-A 700 King Quad	05-07	DAT04136	27,84	DAT04128	30,38
LT-V 700 Twin Peaks	04-06			DAT04126	49,78
LT-A 750 King Quad	08-15	DAT04329	27,84		

YAMAHA	TRAPECIO SUPERIOR			TRAPECIO INFERIOR	
	Año	Referencia	P.V.P.	Referencia	P.V.P.
YFA1 125 Breeze	91-04			DAT04131	23,18
YFM 125 Grizzly	04-13			DAT04131	23,18
YFM 125 Raptor	11-13	DAT04132	22,06	DAT04131	23,18
YFS 200 Blaster	88-06	DAT04130	22,41	DAT04131	23,18
YFM 250 Raptor	08-13	DAT04132	22,06	DAT04131	23,18
YFM 350 Warrior	87-04	DAT04131	23,18	DAT04131	23,18
YFM 350 Raptor	04-13	DAT04131	23,18	DAT04131	23,18
YFZ 350 Banshee	91-06	DAT04132	22,06	DAT04131	23,18
YFZ 450	04-13	DAT04132	22,06	DAT04131	23,18
YFZ 450 R	09-16	DAT04132	22,06	DAT04131	23,18
YFM 660R Raptor	01-05	DAT04133	21,83	DAT04131	23,18
YFM 700R Raptor	06-16	DAT04132	22,06	DAT04131	23,18

4PLAY Casquillos trapecios Yamaha

Referencia	Descripción	P.V.P.
DAT041321	Kit 4 casquillos	7,30
DAT041322	Kit 12 casquillos	17,28



4PLAY Kit casquillos trapecios y buje Polaris

POLARIS	Año	Original	Referencia	P.V.P.
250 Trail Blazer	2006	5434551	DAT04145A	22,05
330 Magnum	2006	5434551	DAT04145A	22,05
330 Trail Blazer	08-14	5434551	DAT04145A	22,05
330 Trail Boss	06-14	5434551	DAT04145A	22,05
400 Ranger EV	2010	5434548	DAT04142	22,05
400 Ranger	10-13	5434548	DAT04142	22,05
400 Trail Blazer	2003	5434551	DAT04145A	22,05
450 Sportsman	06-07	5434551	DAT04145A	22,05
500 ATP	04-05	5434551	DAT04145A	22,05
500 Outlaw	06-07	5434551	DAT04145A	22,05
500 Predator	03-07	5434551	DAT04145A	22,05
500 Ranger	05-09	5434548	DAT04142	22,05
500 Ranger	2004	Casquillo 5434547 Arandela 5132532	DAT04143	35,49
500 Ranger EFI	06-08	5434548	DAT04142	22,05
500 Ranger Crew	2011	5434548	DAT04142	22,05
500 Scrambler	06-12	5434551	DAT04145A	22,05
500 Sportsman EFI	06-09	5434551	DAT04145A	22,05
500 Sportsman EFI Touring	2008	5436832	DAT04144	22,05
500 Sportsman EFI X2	07-08	5436832	DAT04144	22,05
500 Sportsman HO	06-13	5434551	DAT04145A	22,05
500 Sportsman HO	2003	Casquillo 5434551 Arandela 5020677	DAT04145	33,68
500 Sportsman HO Touring	10-13	5436832	DAT04144	22,05
500 Sportsman X2	2006	5436832	DAT04144	22,05
500 Outlaw	06-07	5434575	DAT04141	29,76
500 Predator	03-07	5434575	DAT04141	29,76
525 Outlaw IRS	08-10	5434575	DAT04141	29,76
525 Outlaw S	08-10	5434575	DAT04141	29,76
525 Outlaw	2007	5434575	DAT04141	29,76
550 Sportsman Touring	2010	5436832	DAT04144	22,05
550 Sportsman X2	2010	5436832	DAT04144	22,05
550 Sportsman XP	2010	5436832	DAT04144	22,05
570 Sportsman	2014	5434551	DAT04145A	22,05
700 Ranger Crew	2008	5434548	DAT04142	22,05
700 Ranger XP	05-08	5434548	DAT04142	22,05
700 Sportsman	2006	5434551	DAT04145A	22,05
700 Sportsman EFI	06-07	5434551	DAT04145A	22,05
700 Sportsman EFI X2	2008	5436832	DAT04144	22,05
800 RZR	08-13	5434551	DAT04145A	22,05
800 RZR S	08-13	5434551	DAT04145A	22,05
800 Sportsman EFI HO	2008	5434551	DAT04145A	22,05
800 Sportsman EFI	06-07	5434551	DAT04145A	22,05
800 Sportsman EFI Touring	2008	5436832	DAT04144	22,05
800 Sportsman EFI X2	07-09	5436832	DAT04144	22,05
850 Scrambler 850 XP	2014	5434551	DAT04145A	22,05
850 Sportsman XP	2010	5436832	DAT04144	22,05
850 Sportsman XP Touring	2010	5436832	DAT04144	22,05

Referencia	Original	P.V.P.
DAT04141	5434575	29,76
DAT04142	5434548	22,05
DAT04143	5434547 + 5132532	35,49
DAT04144	5436832	22,05
DAT041441	5436832 / 505 / 832 / 732 / 874	
DAT04145	5434551 + 5020677	33,68
DAT04145A	5434551	22,05
DAT04155	5437229	4,20
DAT04580	5437651	
DAT04581	1543152 / 1543367	5,66
DAT04582	5436798	3,80



Referencia	Nº Piezas	Descripción
DAT04141	16	Ø Int. 16,3mm - Ø Ext. 20,7/31,5 mm - Largo 20,6/25,6mm
DAT04142	8	Ø Int. 16mm - Ø Ext. 20,9/31,7 mm - Largo 27/34,5mm
DAT04143	4	Ø Int. 19,5mm - Ø Ext. 24/35 mm - Largo 95/102mm
	4	Ø Int. 25,5mm - Ø Ext. 35 mm - Largo 6,3mm
DAT04144	8	Ø Int. 16,4mm - Ø Ext. 21/31,2 mm - Largo 24,5/30mm
DAT04145	4	Ø Int. 16mm - Ø Ext. 20,7/31,5 mm - Largo 94/102mm
	4	Ø Int. 21,3mm - Ø Ext. 31,4 mm - Largo 6,3mm
DAT04145A	4	Ø Int. 16,3mm - Ø Ext. 20,7/31,5 mm - Largo 94/101,7mm
DAT04155	1	Ø Int. 15,8/16,5mm - Ø Ext. 21/31,8 mm - Largo 66,6/70mm
DAT04178	2	Ø Int. 11,5mm - Ø Ext. 30,9 mm - Largo 48,3mm
	4	Ø Int. 31,9mm - Ø Ext. 38,3/47,6 mm - Largo 19,2/3,1mm



RUEDAS Y NEUMÁTICOS

MOTOR

ADMISIÓN / ESCAPE
REFRIGERACIÓN

ELECTRICO

SUSPENSIÓN / DIRECCIÓN

FRENOS

TRANSMISIÓN

CONTROLES Y MANDOS

CHASIS

ACCESORIOS

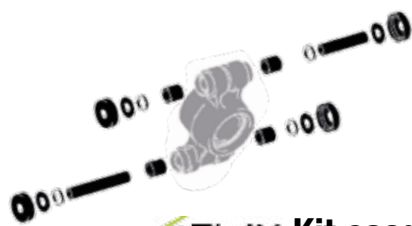

DAT04178

4PLAY Kit casquillos buje trasero

Consta de todo el material necesario para la reconstrucción completa del buje de un solo lado.

ARTIC CAT	Año	Referencia	P.V.P.
Todos los ATV	10-14	DAT04550	

POLARIS	Año	Referencia	P.V.P.
400 Hawkeye	11-12	DAT04178	39,92
400 Sportsman	03-05	DAT04178	39,92
400 Sportsman HO	11-12	DAT04178	39,92
450 Sportsman	06-07	DAT04178	39,92
500 Sportsman	04-12	DAT04178	39,92
600 Sportsman	03-05	DAT04178	39,92
700 Sportsman	02-07	DAT04178	39,92
800 Sportsman	05-12	DAT04178	39,92

YAMAHA	Año	Referencia	P.V.P.
YFM 350 Grizzly IRS	07-13	DAT041381	37,34
YFM 400 Grizzly IRS	07-08	DAT041381	37,34
YFM 450 Kodiak	05-06	DAT041381	37,34
YFM 450 Grizzly	07-14	DAT041381	37,34
YXR 450 Rhino	06-09	DAT041381	37,34
YFM 550 Grizzly	09-14	DAT041381	37,34
YFM 660 Grizzly	02-08	DAT041381	37,34
YXR 660 Rhino	04-07	DAT041381	37,34
YFM 700 Grizzly	07-15	DAT041381	37,34
YXR 700 Rhino	08-13	DAT041381	37,34



P.V.P.
8

BRONCO Tope goma amortiguador

La manera más fácil y barata de endurecer los amortiguadores para los trabajos extremos donde se requiere menor recorrido de amortiguación. Palas nieve, fumigación...

Referencia	Descripción
D0429606	Muelle de Ø 8
D0429607	Muelle de Ø 10

4PLAY Bieleta amortiguador delantero Banshee

Diseñado específicamente para bajar la suspensión delantera del Banshee con un mínimo coste

Referencia	P.V.P.
DAT04059	54,81



Kit casquillos trapecios y buje trasero

Consta de todo el material necesario para la reconstrucción completa de los trapecios y buje de un lado.

ARTIC CAT	Año	Referencia	P.V.P.
400	04-13	DAT04551	16,70
450	10-12	DAT04551	16,70
500	04-13	DAT04551	16,70
550	09-13	DAT04551	16,70
650	04-12	DAT04551	16,70
700	06-13	DAT04551	16,70
1000	09-13	DAT04551	16,70

HONDA	Año	Referencia	P.V.P.
TRX 650 Rincon	03-05	DAT04336	98,92
TRX 680 Rincon	06-14	DAT04336	98,92

KAWASAKI	Año	Referencia	P.V.P.
KVF 650 i Brute Force	06-13	DAT04337	98,92
KVF 750 i Brute Force	05-15	DAT04337	98,92

SUZUKI	Año	Referencia	P.V.P.
LT-A 450 King Quad	07-09	DAT04137	65,31
LT-A 500 king Quad	09-13	DAT04137	65,31
LT-A 700 king Quad	05-07	DAT04137	65,31
LT-A 750 king Quad	08-13	DAT04137	65,31



Kit reparación brazo basculante trasero

CAN AM	Año	Referencia	P.V.P.
330 Outlander	04-05	DAT04552	38,57
400 Outlander	03-15	DAT04552	38,57
500 Outlander	07-12	DAT04552	38,57
500 Renegade	08-12	DAT04552	38,57
650 Outlander	06-12	DAT04552	38,57
800 Outlander	06-11	DAT04552	38,57
800 Outlander MAX	2012	DAT04552	38,57
800 Renegade	07-11	DAT04552	38,57



FRENOS





Pastillas de freno



ARTIC CAT	Año	Lado	PASTILLAS DELANTERAS				PASTILLAS TRASERAS			
			CARBÓN / KEVLAR		SINTERIZADA		CARBÓN / KEVLAR		SINTERIZADA	
			Referencia	P.V.P.	Referencia	P.V.P.	Referencia	P.V.P.	Referencia	P.V.P.
250	2005		DAT05026	7,26	DAT05026F	14,49	DAT05026	7,26	DAT05026F	14,49
300	05-10		DAT05026	7,26	DAT05026F	14,49	DAT05026	7,26	DAT05026F	14,49
400	05-14		DAT05026	7,26	DAT05026F	14,49	DAT05026	7,26	DAT05026F	14,49
400 DVX	08-08		DAT05404	7,74	DAT05404F	14,67			DAT05508F	16,07
425	2012		DAT05026	7,26	DAT05026F	14,49	DAT05026	7,26	DAT05026F	14,49
450	10-14		DAT05026	7,26	DAT05026F	14,49	DAT05026	7,26	DAT05026F	14,49
500	05-14		DAT05026	7,26	DAT05026F	14,49	DAT05026	7,26	DAT05026F	14,49
500 Prowler	2014		DAT05026	7,26	DAT05026F	14,49	DAT05026	7,26	DAT05026F	14,49
550	11-14		DAT05026	7,26	DAT05026F	14,49	DAT05026	7,26	DAT05026F	14,49
550 Prowler	09-14		DAT05026	7,26	DAT05026F	14,49	DAT05026	7,26	DAT05026F	14,49
650	04-14		DAT05026	7,26	DAT05026F	14,49	DAT05026	7,26	DAT05026F	14,49
650 Prowler	06-09		DAT05026	7,26	DAT05026F	14,49	DAT05026	7,26	DAT05026F	14,49
700	06-14		DAT05026	7,26	DAT05026F	14,49	DAT05026	7,26	DAT05026F	14,49
700 Prowler	08-14		DAT05026	7,26	DAT05026F	14,49	DAT05026	7,26	DAT05026F	14,49
1000 Thundercat	08-14		DAT05026	7,26	DAT05026F	14,49	DAT05026	7,26	DAT05026F	14,49
1000 Prowler	10-14		DAT05026	7,26	DAT05026F	14,49	DAT05026	7,26	DAT05026F	14,49
1000 Wildcat	13-14						DAT05026	7,26	DAT05026F	14,49

CAN AM	Año	Lado	PASTILLAS DELANTERAS				PASTILLAS TRASERAS			
			CARBÓN / KEVLAR		SINTERIZADA		CARBÓN / KEVLAR		SINTERIZADA	
			Referencia	P.V.P.	Referencia	P.V.P.	Referencia	P.V.P.	Referencia	P.V.P.
200 Rally	03-07		DAT05559	9,45	DAT05559F	16,99			E64-81380	16,07
DS 250	07-14		DAT05025	7,26	DAT05025F	18,37	DAT05025	7,26	DAT05025F	18,37
330 Outlander	04-05	Izq. Der.	DAT05611 DAT05612	8,09 8,09	E64-62291 E64-62292	15,76 15,76	DAT05611	8,09	DAT05611F	14,80
400 Outlander	03-14	Izq. Der.	DAT05611 DAT05612	8,09 8,09	E64-62291 E64-62292	15,76 15,76	DAT05611	8,09	DAT05611F	14,80
450 DS	08-14		DAT05268		DAT05268F		DAT05810		DAT05810F	
500 Quest	2002	Izq. Der.	DAT05611 DAT05612	8,09 8,09	E64-62291 E64-62292	15,76 15,76	DAT05612	8,09	E64-62292	15,76
500 Traxter	99-00		DAT05610		E64-48886	16,30	DAT05610		E64-48886	16,30
500 Traxter	02-05	Izq. Der.	DAT05611 DAT05612	8,09 8,09	E64-62291 E64-62292	15,76 15,76	DAT05612	8,09	E64-62292	15,76
500 Outlander	07-12	Izq. Der.	DAT05611 DAT05612	8,09 8,09	E64-62291 E64-62292	15,76 15,76	DAT05611	8,09	DAT05611F	14,80
500 Outlander	2013	Izq. Der.	DAT05267 DAT05266		DAT05267F DAT05266F		DAT05266		DAT05266F	
500 Renegade	07-12	Izq. Der.	DAT05611 DAT05612	8,09 8,09	E64-62291 E64-62292	15,76 15,76	DAT05611	8,09	DAT05611F	14,80
500 Renegade	2013	Izq. Der.	DAT05267 DAT05266		DAT05267F DAT05266F		DAT05266		DAT05266F	
650 DS	00-07	Izq. Der.	DAT05611 DAT05612	8,09 8,09	E64-62291 E64-62292	15,76 15,76	DAT05611	8,09	DAT05611F	14,80
650 Outlander	06-12	Izq. Der.	DAT05611 DAT05612	8,09 8,09	E64-62291 E64-62292	15,76 15,76	DAT05611	8,09	DAT05611F	14,80
650 Outlander	2013	Izq. Der.	DAT05267 DAT05266		DAT05267F DAT05266F		DAT05266		DAT05266F	
650 Traxter	04-05	Izq. Der.	DAT05611 DAT05612	8,09 8,09	E64-62291 E64-62292	15,76 15,76	DAT05612	8,09	E64-62292	15,76
800 Commander	11-14	Izq. Der.	DAT05562 DAT05561	6,72 6,72	DAT05562F DAT05561F	15,82 15,82	DAT05561	6,72	DAT05561F	15,82
800 Outlander	06-11	Izq. Der.	DAT05611 DAT05612	8,09 8,09	E64-62291 E64-62292	15,76 15,76	DAT05611	8,09	DAT05611F	14,80
800 Outlander	2013	Izq. Der.	DAT05267 DAT05266		DAT05266F DAT05267F		DAT05266		DAT05266F	
800 Renegade	07-11	Izq. Der.	DAT05611 DAT05612	8,09 8,09	E64-62291 E64-62292	15,76 15,76	DAT05611	8,09	DAT05611F	14,80
800 Renegade	2012	Izq. Der.	DAT05266 DAT05267		DAT05266F DAT05267F		DAT05267		DAT05267F	
1000 Commander	11-14	Izq. Der.	DAT05562 DAT05561	6,72 6,72	DAT05562F DAT05561F	15,82 15,82	DAT05561	6,72	DAT05561F	15,82
1000 Maverick	11-14	Izq. Der.	DAT05562 DAT05561	6,72 6,72	DAT05562F DAT05561F	15,82 15,82	DAT05611 DAT05612	8,09 8,09	DAT05611F DAT05612F	14,80 14,80
1000 Outlander	12-13	Izq. Der.	DAT05266 DAT05267		DAT05266F DAT05267F		DAT05611 DAT05612	8,09 8,09	DAT05611F DAT05612F	14,80 14,80
1000 Renegade	12-13	Izq. Der.	DAT05267 DAT05266		DAT05267F DAT05266F		DAT05267 DAT05266		DAT05267F DAT05266F	



Pastillas de freno



	Año	Lado	PASTILLAS DELANTERAS				PASTILLAS TRASERAS			
			CARBÓN / KEVLAR		SINTERIZADA		CARBÓN / KEVLAR		SINTERIZADA	
GAS GAS			Referencia	P.V.P.	Referencia	P.V.P.	Referencia	P.V.P.	Referencia	P.V.P.
Wild 50	03-05		DMC05554	11,44	DMC05554F	15,60	DMC05554	11,44	DMC05554F	15,60
Wild 125	07-08		DMC05554	11,44	DMC05554F	15,60	DMC05554	11,44	DMC05554F	15,60
Wild 200	2008		DMC05554	11,44	DMC05554F	15,60	DMC05554	11,44	DMC05554F	15,60
Wild 240	03-05		DMC05554	11,44	DMC05554F	15,60	DMC05554	11,44	DMC05554F	15,60
Wild 250	2008		DMC05554	11,44	DMC05554F	15,60	DMC05554	11,44	DMC05554F	15,60
Wild 300	03-06		DMC05554	11,44	DMC05554F	15,60	DMC05554	11,44	DMC05554F	15,60
Wild 450	03-08		DMC05554	11,44	DMC05554F	15,60	DMC05554	11,44	DMC05554F	15,60

	Año	Lado	PASTILLAS DELANTERAS				PASTILLAS TRASERAS			
			CARBÓN / KEVLAR		SINTERIZADA		CARBÓN / KEVLAR		SINTERIZADA	
HONDA			Referencia	P.V.P.	Referencia	P.V.P.	Referencia	P.V.P.	Referencia	P.V.P.
TRX 90 Fourtrax	03-14		DAT05412	4,93			DAT05008	8,55		
TRX 250 EX Sportrax	01-14		DAT05404	7,74	DAT05404F	14,67	E93-39185	6,8		
TRX 250 Recon	97-14		DAT05012	10,15			E93-39185	6,8		
TRX 300 EX Sportrax	93-11		DAT05404	7,74	DAT05404F	14,67	DAT05404	7,74	DAT05404F	14,67
TRX 300 Fourtrax	88-00		E93-39181	6,8			E93-39163	6,8		
TRX 350 Rancher	00-06		E93-39181	6,8			E93-39184	6,8		
TRX 400 EX Sportrax	99-13		DAT05404	7,74	DAT05404F	14,67	DAT05404	7,74	DAT05404F	14,67
TRX 400 Foreman	95-03		E93-39181	6,8			E93-39184	6,8		
TRX 400 Rancher	04-07		E93-39181	6,8			E93-39184	6,8		
TRX 420 Rancher 2x4	07-14		DAT05404	7,74	DAT05404F	14,67	DAT05401	12,98	DAT05401F	20,23
TRX 420 Rancher 4x4	09-14		DAT05404	7,74	DAT05404F	14,67	DAT05011		DAT05011F	
TRX 450 Foreman	98-04		E93-39181	6,8			E93-39184	6,8		
TRX 450 R	04-11				E64-81381	15,63	DAT05401	12,98	DAT05401F	20,23
TRX 500 Rubicon	01-04		E93-39181	6,8			DAT05000	14,92		
TRX 500 Rubicon	05-11		DAT05403	12,92	DAT05403F	18,75	DAT05000	14,92		
TRX 500 Rubicon	12-13		DAT05404	7,74	DAT05404F	14,67	DAT05000	14,92		
TRX 650 Rincon	03-05		E93-39181	6,8			DAT05401	12,98	DAT05401F	20,23
TRX 680 Rincon	06-12		DAT05403	12,92	DAT05403F	18,75	DAT05401	12,98	DAT05401F	20,23
TRX 700 XX	08-11				E64-81381	15,63			DAT05403F	18,75

	Año	Lado	PASTILLAS DELANTERAS				PASTILLAS TRASERAS			
			CARBÓN / KEVLAR		SINTERIZADA		CARBÓN / KEVLAR		SINTERIZADA	
HYOSUNG			Referencia	P.V.P.	Referencia	P.V.P.	Referencia	P.V.P.	Referencia	P.V.P.
TE 450 S	07-10		DAT05453	6,51	E64-51866	14,48	DAT05453	6,51	E64-51866	14,48

	Año	Lado	PASTILLAS DELANTERAS				PASTILLAS TRASERAS			
			CARBÓN / KEVLAR		SINTERIZADA		CARBÓN / KEVLAR		SINTERIZADA	
JOHN DEERE			Referencia	P.V.P.	Referencia	P.V.P.	Referencia	P.V.P.	Referencia	P.V.P.
Trailback 500	04-05	Izq. Der.	DAT05612 DAT05611	8,09 8,09	E64-62292 E64-62291	15,76 15,76	DAT05612	8,09	E64-62292	15,76
Trailback 650	04-05	Izq. Der.	DAT05612 DAT05611	8,09 8,09	E64-62292 E64-62291	15,76 15,76	DAT05612	8,09	E64-62292	15,76

	Año	Lado	PASTILLAS DELANTERAS				PASTILLAS TRASERAS			
			CARBÓN / KEVLAR		SINTERIZADA		CARBÓN / KEVLAR		SINTERIZADA	
KAWASAKI			Referencia	P.V.P.	Referencia	P.V.P.	Referencia	P.V.P.	Referencia	P.V.P.
KFX 50	03-05		DAT05056	6,02			DMX05258	6,09		
KFX 50	07-09		DMX05203				DAT05023	11,76		
KFX 80	03-06		DAT05056	6,02			DAT05102	11,86		
KFX 90	07-14		DMX05203				DAT05023	11,76		
KLF 220 Bayou	88-02		DAT05152	11,11			DAT05555	13,79		
KLF 250 Bayou	03-11		DAT05152	11,11			DAT05555	13,79		
KSF 250 Mojave	87-04		DAT05504	9,30	DAT05404F	14,67	DAT05404	7,74	DAT05404F	14,67
KAF 300 Mule 550	92-03		E93-41075	6,80			DAT05159	11,77		
KEF 300 Lakota	95-03				DAT05404F	14,67	DAT05404	7,74	DAT05404F	14,67
KLF 300 Bayou 2x4	88-04				DAT05560F	18,02	DAT05555	13,79		
KLF 300 Bayou 4x4	89-04	Izq. Der.	DAT05561 DAT05562	6,72 6,72	E64-71971 E64-81380	16,07 16,07	E93-42018	6,8		
KVF 300 Prairie	99-02		DAT05453	6,51	E64-51866	14,48	E93-42018	6,8		

Pastillas de freno



			PASTILLAS DELANTERAS				PASTILLAS TRASERAS			
			CARBÓN / KEVLAR		SINTERIZADA		CARBÓN / KEVLAR		SINTERIZADA	
KVF 360 Prairie	03-13		DAT05453	6,51	E64-51866	14,48	E93-42018	6,8		
KAF 400 Mule	06-09		DAT05006	12,43			DAT05006	12,43		
KFX 400	03-06		DAT05404	7,74	DAT05404F	14,67	DAT05508	9,76	DAT05508F	16,07
KLF400 Bayou 4X4	93-99	Izq.	DAT05561	6,72	E64-71971	16,07				
		Der.	DAT05562	6,72	E64-81380	16,07				
KVF 400 Prairie	97-02		DAT05562	6,72	E64-51866	14,48	E93-42018	6,8		
KAF 450 Mule 1000	95-97		DAT05155				DAT05156	10,17		
KXF 450 R	08-14	Izq.	DAT05016	11,97	DAT05016F	19,42	DAT05404	7,74	DAT05404F	14,67
		Der.	DMX05265	11,97	DMX05265F	19,42				
KAF 540 Mule serie 2000	1993		DAT05155				DAT05156	10,17		
KAF 620 Mule serie 2500/3000	93-08		DAT05155				DAT05156	10,17		
KVF 650 Brute Force	05-13	Izq.	DAT05016	11,97	DAT05016F	19,42				
		Der.	DMX05265	11,97	DMX05265F	19,42				
KVF 650i Brute Force	06-13	Izq.	DAT05562	6,72	E64-81380	16,07				
		Der.	DAT05561	6,72	E64-71971	16,07				
KVF 650 Prairie	02-03	Izq.	DAT05016	11,97	DAT05016F	19,42				
		Der.	DMX05265	11,97	DMX05265F	19,42				
KFX 700 V-Force	04-09	Izq.	DAT05016	11,97	DAT05016F	19,42				
		Der.	DMX05265	11,97	DMX05265F	19,42				
KVF 700 Prairie	04-06	Izq.	DAT05016	11,97	DAT05016F	19,42				
		Der.	DMX05265	11,97	DMX05265F	19,42				
KVF 750i Brute Force	05-14	Izq.	DAT05562	6,72	E64-81380	16,07				
		Der.	DAT05561	6,72	E64-71971	16,07				
KRF 750 Teryx	08-13	Izq.	DAT05562	6,72	E64-81380	16,07				
		Der.	DAT05561	6,72	E64-71971	16,07				
KRF 750 Teryx	2014	Izq.	DAT05562	6,72	E64-81380	16,07				
		Der.	DAT05561	6,72	E64-71971	16,07				
KAF 950 Mule Diesel	03-08		DAT05155				DAT05156	10,17		

			PASTILLAS DELANTERAS				PASTILLAS TRASERAS			
			CARBÓN / KEVLAR		SINTERIZADA		CARBÓN / KEVLAR		SINTERIZADA	
KTM	Año	Lado	Referencia	P.V.P.	Referencia	P.V.P.	Referencia	P.V.P.	Referencia	P.V.P.
450 SX	09-12		DAT05264		DAT05264F		DAT05263		DAT05263F	
450 XC	08-12		DAT05264		DAT05264F		DAT05263		DAT05263F	
505 SX	09-12		DAT05264		DAT05264F		DAT05263		DAT05263F	
525 XC	08-12		DAT05264		DAT05264F		DAT05263		DAT05263F	

			PASTILLAS DELANTERAS				PASTILLAS TRASERAS			
			CARBÓN / KEVLAR		SINTERIZADA		CARBÓN / KEVLAR		SINTERIZADA	
KYMCO	Año	Lado	Referencia	P.V.P.	Referencia	P.V.P.	Referencia	P.V.P.	Referencia	P.V.P.
MXer 50	04-08		DAT05014	8,21			DAT05024			
MXer 50 (disco trasero)	08-09		DAT05014	8,21			DAT05023	11,76		
MXer 70 Mongoose	07-14		DAT05014	8,21			DAT05023	11,76		
MXer 90 Mongoose	02-14		DAT05412	4,93			DAT05023	11,76		
MXer 150	03-05		DAT05412	4,93			DAT05023	11,76		
MXU 150	05-14		DAT05412	4,93			DAT05023	11,76		
KXR 250	04-09		DAT05025	7,26	DAT05025F	18,37	DAT05013	10,18	DAT05013F	16,49
MXU 250	04-10		DAT05025	7,26	DAT05025F	18,37	DAT05013	10,18	DAT05013F	16,49
Mongoose 300	06-14		DAT05025	7,26	DAT05025F	18,37	DAT05013	10,18	DAT05013F	16,49
Maxxer 300	06-08		DAT05025	7,26	DAT05025F	18,37	DAT05013	10,18	DAT05013F	16,49
MXU 300	05-14		DAT05025	7,26	DAT05025F	18,37	DAT05025	7,26	DAT05025F	18,37
MXU 375 IRS	08-12		DAT05026	7,26	DAT05026F	14,49	DAT05026	7,26	DAT05026F	14,49
Maxxer 450 IRS	11-14		DAT05026	7,26	DAT05026F	14,49	DAT05026	7,26	DAT05026F	14,49
MXU 450 IRS	11-14		DAT05026	7,26	DAT05026F	14,49	DAT05026	7,26	DAT05026F	14,49
MXU 500	06-11		DAT05025	7,26	DAT05025F	18,37	DAT05025	7,26	DAT05025F	18,37
MXU 500i	09-13				DAT05274F	17,12			DAT05274F	17,12
MXU 550	12-13				DAT05274F	17,12			DAT05274F	17,12
MXU 700	13-14				DAT05274F	17,12			DAT05274F	17,12

			PASTILLAS DELANTERAS				PASTILLAS TRASERAS			
			CARBÓN / KEVLAR		SINTERIZADA		CARBÓN / KEVLAR		SINTERIZADA	
POLARIS	Año	Lado	Referencia	P.V.P.	Referencia	P.V.P.	Referencia	P.V.P.	Referencia	P.V.P.
Outlaw 50	08-14		DAT05014	8,21			DAT05054	8,55		
Predator 50	04-06		DAT05014	8,21			DAT05054	8,55		
Scrambler 50	01-03		DAT05014	8,21			DAT05054	8,55		
Outlaw 90	07-13		DAT05014	8,21			DAT05054	8,55		
Predator 90	03-06		DAT05014	8,21			DAT05054	8,55		
Scrambler 90	01-03		DAT05014	8,21			DAT05054	8,55		



Pastillas de freno



		PASTILLAS DELANTERAS				PASTILLAS TRASERAS			
		CARBÓN / KEVLAR		SINTERIZADA		CARBÓN / KEVLAR		SINTERIZADA	
Sportsman 90	01-13	DAT05014	8,21			DAT05054	8,55		
Phoenix 200 (mordaza)	05-14	DAT05559	9,45	DAT05559F	16,99				
Phoenix 200 (disco)	05-08	DAT05559	9,45	DAT05559F	16,99	DAT05559	9,45	DAT05559F	16,99
Sawtooth 200 (disco)	06-07	DAT05559	9,45	DAT05559F	16,99	DAT05559	9,45	DAT05559F	16,99
Trail Blazer 250	90-98	DAT05654	7,24	DAT05654F	13,55			E64-48891	16,3
Trail Blazer 250	99-04	DAT05654	7,24	DAT05654F	13,55			DAT05657F	
Trail Blazer 250	05-06	DAT05654	7,24	DAT05654F	13,55	DAT05015	11,24	DAT05015F	15,54
Trail Boss 250	91-99	DAT05654	7,24	DAT05654F	13,55			E64-48891	16,3
Xplorer 250	2000	DAT05654	7,24	DAT05654F	13,55			DAT05657F	
Hawkeye 300	2006	DAT05026	7,26	DAT05026F	14,49	DAT05026	7,26	DAT05026F	14,49
Hawkeye 300	07-09	DAT05654	7,24	DAT05654F	13,55	DAT05026	7,26	DAT05026F	14,49
Sportsman 300	08-10	DAT05654	7,24	DAT05654F	13,55	DAT05654	7,24	DAT05654F	13,55
Xpress 300	96-97	DAT05654	7,24	DAT05654F	13,55			E64-48891	16,3
Magnum 325	00-01	DAT05654	7,24	DAT05654F	13,55			DAT05657F	
Magnum 325	2002	DAT05654	7,24	DAT05654F	13,55	DAT05015	11,24	DAT05015F	15,54
Xpedition 325	2000	DAT05654	7,24	DAT05654F	13,55			DAT05657F	
Xpedition 325	2002	DAT05654	7,24	DAT05654F	13,55			DAT05015F	15,54
Trail Boss 325	00-02	DAT05654	7,24	DAT05654F	13,55			DAT05657F	
Magnum 330	03-06	DAT05654	7,24	DAT05654F	13,55	DAT05015	11,24	DAT05015F	15,54
Trail Boss 330	03-04	DAT05654	7,24	DAT05654F	13,55			DAT05657F	
Trail Boss 330	05-13	DAT05654	7,24	DAT05654F	13,55			DAT05015F	15,54
Trail Blazer 330	08-13	DAT05654	7,24	DAT05654F	13,55			DAT05015F	15,54
Sportsman 335	99-00	DAT05654	7,24	DAT05654F	13,55			DAT05657F	
Hawkeye 400	13-14	DAT05654	7,24	DAT05654F	13,55	DAT05038	12,6	DAT05038F	14,07
Scrambler 400	95-97	DAT05654	7,24	DAT05654F	13,55			E64-48891	16,3
Scrambler 400	98-02	DAT05654	7,24	DAT05654F	13,55			DAT05657F	
Xplorer 400	95-98	DAT05654	7,24	DAT05654F	13,55			E64-48891	16,3
Xplorer 400	99-02	DAT05654	7,24	DAT05654F	13,55			DAT05657F	
Sport 400L	94-98	DAT05654	7,24	DAT05654F	13,55			E64-48891	16,3
Sport 400L	99-00	DAT05654	7,24	DAT05654F	13,55			DAT05657F	
Sportsman 400L	94-97	DAT05654	7,24	DAT05654F	13,55			E64-48891	16,3
Sportsman 400	01-02	DAT05654	7,24	DAT05654F	13,55			DAT05657F	
Sportsman 400	03-04	DAT05654	7,24	DAT05654F	13,55	DAT05015	11,24	DAT05015F	15,54
Sportsman 400	08-10	DAT05654	7,24	DAT05654F	13,55	DAT05654	7,24	DAT05654F	13,55
Sportsman 400	11-14	DAT05654	7,24	DAT05654F	13,55	DAT05038	12,6	DAT05038F	14,07
Trail Blazer 400	2003	DAT05654	7,24	DAT05654F	13,55			DAT05657F	
Magnum 425	95-98	DAT05654	7,24	DAT05654F	13,55			E64-48891	16,3
Outlaw S 450	09-10	DAT05419	13,76	DAT05419F	16,07	DAT05654	7,24	DAT05654F	13,55
Sportsman 450	06-07	DAT05654	7,24	DAT05654F	13,55	DAT05015	11,24	DAT05015F	15,54
Magnum 500	99-01	DAT05654	7,24	DAT05654F	13,55			DAT05657F	
Magnum 500	02-03	DAT05654	7,24	DAT05654F	13,55	DAT05015	11,24	DAT05015F	15,54
Scrambler 500	1997	DAT05654	7,24	DAT05654F	13,55			E64-48891	16,3
Scrambler 500	98-04	DAT05654	7,24	DAT05654F	13,55			DAT05657F	
Scrambler 500	05-13	DAT05654	7,24	DAT05654F	13,55	DAT05015	11,24	DAT05015F	15,54
Outlaw 500	06-07	DAT05654	7,24	DAT05654F	13,55	DAT05654	7,24	DAT05654F	13,55
Predator 500	03-07	DAT05654	7,24	DAT05654F	13,55	DAT05654	7,24	DAT05654F	13,55
Xplorer 500	1997	DAT05654	7,24	DAT05654F	13,55			E64-48891	16,3
Sportsman 500	96-97	DAT05654	7,24	DAT05654F	13,55			E64-48891	16,3
Sportsman 500	98-02	DAT05654	7,24	DAT05654F	13,55			DAT05657F	
Sportsman 500	03-08	DAT05654	7,24	DAT05654F	13,55	DAT05015	11,24	DAT05015F	15,54
Sportsman 500 X2	07-09	DAT05654	7,24	DAT05654F	13,55	DAT05654	7,24	DAT05654F	13,55
Sportsman 500 Forest	2012	DAT05654	7,24	DAT05654F	13,55	DAT05015	11,24	DAT05015F	15,54
Sportsman 500 Touring	08-11	DAT05654	7,24	DAT05654F	13,55	DAT05654	7,24	DAT05654F	13,55
Sportsman 500 Touring	12-13	DAT05654	7,24	DAT05654F	13,55	DAT05019		DAT05019F	
Sportsman 500 EFI	08-11	DAT05654	7,24	DAT05654F	13,55	DAT05015	11,24	DAT05015F	15,54
Sportsman 500 XP	2009	DAT05038	12,6	DAT05038F	14,07	DAT05038	12,6	DAT05038F	14,07
Outlaw 525	08-11	DAT05419	13,76	DAT05419F	16,07	DAT05015	11,24	DAT05015F	15,54
Sportsman 550 XP	09-14	DAT05038	12,6	DAT05038F	14,07	DAT05038	12,6	DAT05038F	14,07
Sportsman 570	11-14	DAT05654	7,24	DAT05654F	13,55	DAT05038	12,6	DAT05038F	14,07
Sportsman 600	03-05	DAT05654	7,24	DAT05654F	13,55	DAT05015	11,24	DAT05015F	15,54
Sportsman 700	02-08	DAT05654	7,24	DAT05654F	13,55	DAT05015	11,24	DAT05015F	15,54
Sportsman 800 EFI	05-09	DAT05654	7,24	DAT05654F	13,55	DAT05015	11,24	DAT05015F	15,54

RUEDAS Y NEUMÁTICOS

MOTOR

ADMISIÓN / ESCAPE
REFRIGERACIÓN

ELÉCTRICO

SUSPENSIÓN / DIRECCIÓN

FRENOS

TRANSMISIÓN

CONTROLES Y MANDOS

CHASIS

ACCESORIOS

Pastillas de freno



		PASTILLAS DELANTERAS				PASTILLAS TRASERAS			
		CARBÓN / KEVLAR		SINTERIZADA		CARBÓN / KEVLAR		SINTERIZADA	
Sportsman 800 EFI	10-14	DAT05654	7,24	DAT05654F	13,55	DAT05038	12,6	DAT05038F	14,07
Sportsman 800 X2	07-09	DAT05654	7,24	DAT05654F	13,55	DAT05015	11,24	DAT05015F	15,54
Sportsman 800 Forest	2012	DAT05038	12,6	DAT05038F	14,07	DAT05038	12,6	DAT05038F	14,07
RZR 800	08-14	DAT05419	13,76	DAT05419F	16,07	DAT05654	7,24	DAT05654F	13,55
RZR "S" 800	09-13	DAT05419	13,76	DAT05419F	16,07	DAT05654	7,24	DAT05654F	13,55
RZR 800 "4"	10-13			DAT05039F	18,58			DAT05019F	
Sportsman 850 XP	09-14	DAT05038	12,6	DAT05038F	14,07	DAT05038	12,6	DAT05038F	14,07
RZR 900 XP (incluido EPS)	11-14			DAT05039F	18,58			DAT05019F	
RZR 900 XP "4"	13-14			DAT05039F	18,58			DAT05039F	18,58
RZR 1000 XP	2014			DAT05039F	18,58			DAT05039F	18,58

	Año	Lado	PASTILLAS DELANTERAS				PASTILLAS TRASERAS			
			CARBÓN / KEVLAR		SINTERIZADA		CARBÓN / KEVLAR		SINTERIZADA	
SUZUKI			Referencia	P.V.P.	Referencia	P.V.P.	Referencia	P.V.P.	Referencia	P.V.P.
LT-A 50 QuadSport	02-05		DAT05056	6,02			DMX05258	6,09		
LT-Z 50 QuadSport	06-11		DAT05056	6,02			DMX05258	6,09		
LT 80 QuadSport	87-06		DAT05056	6,02			DAT05102	11,86		
LT-Z 90 QuadSport	07-14		DMX05258	6,09			DAT05102	11,86		
LT 160 Quadrunner	89-04		DAT05104	7,87			E93-42006	6,80		
LT-F 250 Ozark	02-14		DAT05453	6,51	E64-51866	14,48	DAT05406	18,77		
LT-F 250 Quadrunner	89-02		E93-41075	6,80			E93-41073	11,50		
LT-Z 250 QuadSport	04-09		DAT05400		DAT05400F		DAT05406	18,77		
LT-F 300 King Quad	99-01		DAT05108	9,86			E93-41057	11,50		
LT-F 300 King Quad	2002	Izq. Der.	DAT05562 DAT05561	6,72 6,72	E64-81380 E64-71971	16,07 16,07	E93-41057	11,50		
LT-A 400 Eiger	02-07		DAT05453	6,51	E64-51866	14,48	DMC05276	12,60		
LT-F 400 Eiger	02-07		DAT05453	6,51	E64-51866	14,48	DMC05276	12,60		
LT-A 400 King Quad	08-09	Izq. Der.	DAT05032 DAT05033	12,18 12,18	DAT05032F DAT05033F	17,54 17,54	DMC05276	12,60		
LT-F 400 King Quad	11-14	Izq. Der.	DAT05032 DAT05033	12,18 12,18	DAT05032F DAT05033F	17,54 17,54	DMC05276	12,60		
LT-Z 400 QuadSport	03-14		DAT05404	7,74	DAT05404F	14,67	DAT05508	9,76	DAT05508F	16,07
LT-A 450i King Quad	07-11	Izq. Der.	DAT05032 DAT05033	12,18 12,18	DAT05032F DAT05033F	17,54 17,54				
LT-R 450	06-11	Izq. Der.	DAT05561 DAT05562	6,72 6,72	E64-71971 E64-81380	16,07 16,07	DAT05508	9,76	DAT05508F	16,07
LT-A 500 King Quad	09-14	Izq. Der.	DAT05032 DAT05033	12,18 12,18	DAT05032F DAT05033F	17,54 17,54				
LT-A 500 Quadrunner	00-01	Izq. Der.	DAT05561 DAT05562	6,72 6,72	E64-71971 E64-81380	16,07 16,07	E93-41057	11,50		
LT-F 500 Quadrunner	98-02	Izq. Der.	DAT05561 DAT05562	6,72 6,72	E64-71971 E64-81380	16,07 16,07	E93-41057	11,50		
LT-A 500 Vinson	2002		DAT05453	6,51	E64-51866	14,48	DAT05612	8,09	E64-62292	15,76
LT-A 500 Vinson	03-07		DAT05453	6,51	E64-51866	14,48	DAT05017	11,07	DAT05017F	18,58
LT-F 500 Vinson	04-07		DAT05453	6,51	E64-51866	14,48	DAT05017	11,07	DAT05017F	18,58
LT-A 550 King Quad	09-14	Izq. Der.	DAT05032 DAT05033	12,18 12,18	DAT05032F DAT05033F	17,54 17,54				
LT-A 700 King Quad	05-11	Izq. Der.	DAT05032 DAT05033	12,18 12,18	DAT05032F DAT05033F	17,54 17,54				
LT-V 700 Twin Peaks	04-05	Izq. Der.	DAT05016 DMX05265	11,97 11,97	DAT05016F DMX05265F	19,42 19,42				
LT-A 750i King Quad	08-14	Izq. Der.	DAT05032 DAT05033	12,18 12,18	DAT05032F DAT05033F	17,54 17,54				

	Año	Lado	PASTILLAS DELANTERAS				PASTILLAS TRASERAS			
			CARBÓN / KEVLAR		SINTERIZADA		CARBÓN / KEVLAR		SINTERIZADA	

SYM			Referencia	P.V.P.	Referencia	P.V.P.	Referencia	P.V.P.	Referencia	P.V.P.
Quadlander 300	07-10		DAT05025	7,26	DAT05025F	18,37	DAT05025	7,26	DAT05025F	18,37
Quadlander 600	08-10		DAT05453	6,51	E64-51866	14,48	DAT05025	7,26	DAT05025F	18,37



Pastillas de freno



YAMAHA	Año	Lado	PASTILLAS DELANTERAS				PASTILLAS TRASERAS			
			CARBÓN / KEVLAR		SINTERIZADA		CARBÓN / KEVLAR		SINTERIZADA	
			Referencia	P.V.P.	Referencia	P.V.P.	Referencia	P.V.P.	Referencia	P.V.P.
YFM 50 Raptor	04-08		DAT05653	8,75			DAT05462	7,73		
YFM 80 Badger	92-01		DAT05653	8,75			DAT05462	7,73		
YFM 80 Raptor	02-08		DAT05653	8,75			DAT05462	7,73		
YFM 80 Grizzly	05-08		DAT05653	8,75			DAT05462	7,73		
YFM 90 Raptor	09-13		DAT05058				DAT05560			
YFA 125 Brezze	92-04		DAT05653	8,75			DAT05462	7,73		
YFM 125 Grizzly	04-13		DAT05653	8,75			DAT05462	7,73		
YFM 125 Raptor	11-13		DAT05453	6,51	E64-51866	14,48	DAT05404	7,74	DAT05404F	14,67
YFS 200 Blaster	88-02		DAT05653	8,75			DAT05455	10,39		
YFS 200 Blaster	03-06		DAT05453	6,51	E64-51866	14,48	DAT05404	7,74	DAT05404F	14,67
YFB 250 Timberwolf	92-94		DAT05653	8,75			E93-27228	6,80		
YFB 250 Timberwolf	95-00		E93-27228	6,80			E93-27228	6,80		
YFM 250 Bear Tracker	99-00		E93-27228	6,80			E93-27228	6,80		
YFM 250 Bear Tracker	01-04		DAT05453	6,51	E64-51866	14,48	E93-27228	6,80		
YFM 250 Bruin	05-06		DAT05453	6,51	E64-51866	14,48	DAT05408	17,94		
YFM 250 Big Bear	07-09		DAT05453	6,51	E64-51866	14,48	DAT05408	17,94		
YFM 250 Raptor	08-13	Izq. Der.	DAT05028 DAT05027	11,44 11,44	DAT05028F DAT05027F	18,27 18,27	DAT05404	7,74	DAT05404F	14,67
YFM 350 Big Bear semi.	96-98		E93-27220	6,80			E93-27209	8,90		
YFM 350 Bruin	04-06		DAT05453	6,51	E64-51866	14,48	DAT05408	17,94		
YFM 350 Grizzly	07-16		DAT05453	6,51	E64-51866	14,48	DAT05408	17,94		
YFM 350 Grizzly IRS	07-11		DAT05453	6,51	E64-51866	14,48				
YFM 350 Raptor	04-13		DAT05404	7,74	DAT05404F	14,67	DAT05404	7,74	DAT05404F	14,67
YFM 350 Warrior	89-04		DAT05453	6,51	E64-51866	14,48	DAT05404	7,74	DAT05404F	14,67
YFM 350 Wolverine semi.	95-05		DAT05453	6,51	E64-51866	14,48	DAT05404	7,74	DAT05404F	14,67
YFM 350 Wolverine	06-09		DAT05453	6,51	E64-51866	14,48	DAT05408	17,94		
YFZ 350 Banshee	90-06		DAT05453	6,51	E64-51866	14,48	DAT05404	7,74	DAT05404F	14,67
YFM 400 Big Bear PRO	00-06		DAT05453	6,51	E64-51866	14,48	DAT05611	8,09	DAT05611F	14,80
YFM 400 Grizzly IRS	07-08		DAT05453	6,51	E64-51866	14,48	DAT05611	8,09	DAT05611F	14,80
YFM 400 Kodiak semi.	93-99		E93-27220	6,80			E93-27209	8,90		
YFM 400 Kodiak	00-06		DAT05453	6,51	E64-51866	14,48	DAT05611	8,09	DAT05611F	14,80
YFM 450 Grizzly	07-08		DAT05453	6,51	E64-51866	14,48	DAT05611	8,09	DAT05611F	14,80
YFM 450 Grizzly	09-14		DAT05453	6,51	E64-51866	14,48				
YFM 450 Kodiak	04-06		DAT05453	6,51	E64-51866	14,48	DAT05611	8,09	DAT05611F	14,80
YFM 450 Wolverine	06-11		DAT05453	6,51	E64-51866	14,48	DAT05611	8,09	DAT05611F	14,80
YFZ 450	04-05	Izq. Der.	DAT05561 DAT05562	6,72 6,72	E64-71971 E64-81380	16,07 16,07	DAT05404	7,74	DAT05404F	14,67
YFZ 450	06-14	Izq. Der.	DAT05561 DAT05562	6,72 6,72	E64-71971 E64-81380	16,07 16,07			DAT05024F	15,80
YFZ 450 R	09-16	Izq. Der.	DAT05561 DAT05562	6,72 6,72	E64-71971 E64-81380	16,07 16,07			DAT05024F	15,80
YXR 450 Rhino	06-09	Izq. Der.	DAT05561 DAT05562	6,72 6,72	E64-71971 E64-81380	16,07 16,07	DAT05021	12,18	E64-62292	15,76
YFM 550 Grizzly	09-14	Izq. Der.	DAT05028 DAT05027	11,44 11,44	DAT05028F DAT05027F	18,27 18,27	DAT05030 DAT05029	11,76 11,76	DAT05030F DAT05029F	17,65 17,65
YFM 600 Grizzly	98-01		DAT05404	7,74	DAT05404F	14,67	E93-27209	8,90		
YFM 660 Grizzly	02-08		DAT05404	7,74	DAT05404F	14,67	DAT05420	13,98		
YFM 660 Raptor	01-05		DAT05404	7,74	DAT05404F	14,67	DAT05404	7,74	DAT05404F	14,67
YXR 660 Rhino	03-07	Izq. Der.	DAT05561 DAT05562	6,72 6,72	E64-71971 E64-81380	16,07 16,07	DAT05021	12,18	E64-62292	15,76
YFM 700 Grizzly	07-16	Izq. Der.	DAT05028 DAT05027	11,44 11,44	DAT05028F DAT05027F	18,27 18,27	DAT05030 DAT05029	11,76 11,76	DAT05030F DAT05029F	17,65 17,65
YFM 700 Kodiak	2016	Izq. Der.	DAT05028 DAT05027	11,44 11,44	DAT05028F DAT05027F	18,27 18,27	DAT05030 DAT05029	11,76 11,76	DAT05030F DAT05029F	17,65 17,65
YFM 700 Raptor	06-12	Izq. Der.	DAT05561 DAT05562	6,72 6,72	E64-71971 E64-81380	16,07 16,07	DAT05021	12,18	E64-62292	15,76
YFM 700 Raptor	13-16	Izq. Der.	DAT05561 DAT05562	6,72 6,72	E64-71971 E64-81380	16,07 16,07			DAT05024F	15,80
YXR 700 Rhino	08-14	Izq. Der.	DAT05561 DAT05562	6,72 6,72	E64-71971 E64-81380	16,07 16,07	DAT05561 DAT05562	6,72 6,72	E64-71971 E64-81380	16,07 16,07

RUEDAS Y NEUMÁTICOS
MOTOR
ADMISIÓN / ESCAPE REFRIGERACIÓN
ELECTRICO
SUSPENSIÓN / DIRECCIÓN
FRENOS
TRANSMISIÓN
CONTROLES Y MANDOS
CHASIS
ACCESORIOS

XPEED Discos de freno

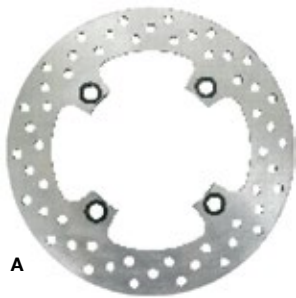

A



B

		DELANTERO		TRASERO		
HONDA	Año	Modelo	Referencia	P.V.P.	Referencia	P.V.P.
TRX 250 R		A	R8102FA	41,61	R8102RA	53,64
TRX 300 Sportrax	93-09	A	R8101FA	41,61		
		B	R8101FB	41,61		
TRX 400 Sportrax	99-09	A	R8101FA	41,61	R8101RA	53,64
		B	R8101FB	41,61	R8101RB	53,64
TRX 450 R		A	R8101FA	41,61		
		B	R8101FB	41,61		

		DELANTERO		TRASERO		
SUZUKI	Año	Modelo	Referencia	P.V.P.	Referencia	P.V.P.
LTZ 250	04-08	A	R8401FA	41,61	R8401RA	53,64
		B	R8401FB	41,61	R8401RB	53,64
LTZ 400	03-09	A	R8401FA	41,61	R8401RA	53,64
		B	R8401FB	41,61	R8401RB	53,64
LTR 450	06-08	A	R8402FA	41,61		
		B	R8402FB	41,61		

		DELANTERO		TRASERO		
YAMAHA	Año	Modelo	Referencia	P.V.P.	Referencia	P.V.P.
YFS 200 Blaster	03-06	A	R8301FA	41,61	R8301RA	53,64
		B	R8301FB	41,61	R8301RB	53,64
YFM 250 Raptor	08-10	A	R8301FA	41,61		
		B	R8301FB	41,61		
YFM 250 Bruin	01-08	A	R8301FA	41,61		
		B	R8301FB	41,61		
YFM 350 Raptor	05-12	A	R8301FA	41,61	R8302RA	53,64
		B	R8301FB	41,61	R8302RB	53,64
YFM 350 Warrior	89-04	A	R8301FA	41,61	R8304RA	53,64
		B	R8301FB	41,61	R8304RB	53,64
YFZ 350 Banshee	91-08	A	R8301FA	41,61	R8301RA	53,64
		B	R8301FB	41,61	R8301RB	53,64
YFM 400 Kodiak	00-02	A	R8301FA	41,61	R8301RA	53,64
		B	R8301FB	41,61	R8301RB	53,64
YFZ 450	04-05	A	R8301FA	41,61	R8302RA	53,64
		B	R8301FB	41,61	R8302RB	53,64
YFZ 450	06-08	A	R8301FA	41,61	R8303RA	53,64
		B	R8301FB	41,61	R8303RB	53,64
YFM 660 Raptor	01-05	A	R8301FA	41,61	R8301RA	53,64
		B	R8301FB	41,61	R8301RB	53,64
YFM 660 Grizzly	02-06	A	R8401RA	53,64		
		B	R8401RB	53,64		
YFM 700 Raptor	06-09	A	R8301FA	41,61	R8303RA	53,64
		B	R8301FB	41,61	R8303RB	53,64



BRONCO

Kit reparación pinza de freno

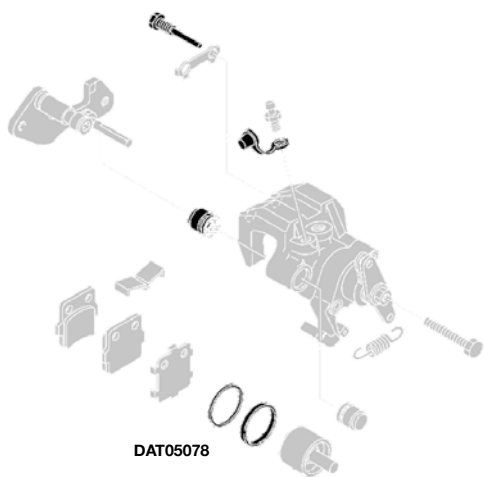

DAT05078



DAT05071

HONDA	Año	DELANTERO		TRASERO	
		Referencia	P.V.P.	Referencia	P.V.P.
TRX 250 EX Sportrax	01-09	DAT05060	17,56		
TRX 300 EX Sportrax	93-09	DAT05060	17,56	DAT05073	
TRX 400 EX Sportrax	99-09	DAT05060	17,56	DAT05073	
TRX 420	07-12	DAT05062	17,56		
TRX 450 R	04-12	DAT05063	17,56	DAT05075	
TRX 500 Foreman	05-11	DAT05064	19,16		
TRX 500 Rubicon	05-12	DAT05064	19,16		
TRX 650 Rincon	03-05			DAT05076	
TRX 680 Rincon	06-12	DAT05064	19,16	DAT05076	
TRX 700 XX	08-09	DAT05063	17,56	DAT05075	

KAWASAKI	Año	DELANTERO		TRASERO	
		Referencia	P.V.P.	Referencia	P.V.P.
KVF 300 Prairie	99-02	DAT05065	16,63		
KVF 360 Prairie	03-13	DAT05065	16,63		
KVF 400 Prairie	97-02	DAT05065	16,63		
KLF 400 Bayou	93-99	DAT05066	16,10		
KVF 650 Brute Force	06-09	DAT05066	16,10		
KRF 750 Teryx	08-09	DAT05066	16,10		
KVF 750 Brute Force	05-12	DAT05066	16,10		

SUZUKI	Año	DELANTERO		TRASERO	
		Referencia	P.V.P.	Referencia	P.V.P.
LT-F 250 Ozark	02-09	DAT05043	18,65		
LT-Z 250 QuadSport	04-09	DAT05043	18,65		
LT-F 400 Eiger	02-07	DAT05043	18,65		
LT-F 400 Eiger	2008	DAT05067	18,22		
LT-Z 400	03-09	DAT05043	18,65		
LT-A 400	02-07	DAT05043	18,65		
LT-F 400	02-07	DAT05043	18,65		
LT-A 450 King Quad	07-08	DAT05067	18,22		
LT-R 450 QuadRacer	06-08	DAT05068	18,22		
LT-A 500 Vinson	00-01	DAT05068	18,22		
LT-A 500 King Quad	02-07	DAT05043	18,65		
LT-F 500 Quadrunner	98-02	DAT05068	18,22		
LT-F 500 Vinson	2003	DAT05043	18,65		
LT-F 500 King Quad	04-07	DAT05043	18,65		
LT-A 700 King Quad	06-07	DAT05067	18,22		
LT-A 750 King Quad	2008	DAT05067	18,22		

YAMAHA	Año	DELANTERO		TRASERO	
		Referencia	P.V.P.	Referencia	P.V.P.
YFM 250 Bruin	05-09	DAT05069	15,44		
YFS 200 Blaster	04-06	DAT05069	15,44	DAT05077	
YFM 250 Raptor	08-09	DAT05070	14,12	DAT05078	
YFM 250 Raptor	10-12	DAT05070	14,12	DAT05077	
YFM 250 Beartracker	01-04	DAT05069	15,44		
YFM 350 Bruin	04-06	DAT05069	15,44		
YFM 350 Big Bear	1999	DAT05069	15,44		
YFM 350 Grizzly	07-12	DAT05069	15,44		
YFM 350 Wolverine	95-05	DAT05069	15,44	DAT05079	
YFM 350 R	04-12	DAT05069	15,44	DAT05078	
YFM 350 Warrior	87-04	DAT05069	15,44	DAT05079	
YFZ 350 Banshee	90-06	DAT05069	15,44	DAT05079	
YFM 400 Grizzly	00-12	DAT05069	15,44		
YFM 400 Kodiak	1999	DAT05069	15,44		
YFM 400 Kodiak	00-06	DAT05069	15,44	DAT05080	
YFM 450 Kodiak	03-06	DAT05069	15,44	DAT05080	
YFM 450 Grizzly	2007	DAT05069	15,44	DAT05080	
YFM 450 Grizzly	08-12	DAT05069	15,44		
YFM 450 Wolverine	06-10	DAT05069	15,44	DAT05080	
YFZ 450	04-05	DAT05071	17,56	DAT05078	
YFZ 450	06-09	DAT05071	17,56	DAT05081	
YFZ 450 R	09-12	DAT05071	17,56	DAT05081	
YFM 550 Grizzly	09-14	DAT05070	14,12	DAT05082	
YFM 600 Grizzly	98-01	DAT05072	16,90		
YFM 660 Grizzly	02-08	DAT05072	16,90	DAT05083	
YFM 660 Raptor	01-05	DAT05069	15,44	DAT05077	
YFM 700 Grizzly	07-14	DAT05070	14,12	DAT05082	
YFM 700 Raptor	06-12	DAT05071	17,56	DAT05084	

RUEDAS Y NEUMÁTICOS

MOTOR

ADMISIÓN / ESCAPE
REFRIGERACIÓN

ELECTRICO

SUSPENSIÓN / DIRECCIÓN

FRENOS

TRANSMISIÓN

CONTROLES Y MANDOS

CHASIS

ACCESORIOS

BRONCO Kit reparación bomba de freno

HONDA	Año	DELANTERO		TRASERO	
		Referencia	P.V.P.	Referencia	P.V.P.
TRX 250 Recon	97-16	DAT05854	15,31		
TRX 250 EX Sportrax	01-16	DAT05854	15,31		
TRX 300 EX Sportrax	93-04	DAT05851	17,42	DAT05853	21,20
TRX 300 EX Sportrax	05-09	DAT05854	15,31	DAT05853	21,20
TRX 350 Rancher	00-03	DAT05854	15,31		
TRX 350 Rancher	04-06	DAT05855	14,26		
TRX 400 EX Sportrax	99-14	DAT05854	15,31		
TRX 400 Foreman	95-03	DAT05852	14,65		
TRX 400 Foreman	04-07	DAT05855	14,26		
TRX 420 Rancher	07-08	DAT05855	14,26		
TRX 450 Rancher	98-01	DAT05852	14,65		
TRX 450 Rancher	02-04	DAT05852	14,65		
TRX 450 R	04-14	DAT05856	20,20	DAT05853	21,20
TRX 500 Rubicon	01-03	DAT05852	14,65		
TRX 500 Rubicon	2004	DAT05852	14,65		
TRX 500 Rubicon	05-08	DAT05855	14,26		
TRX 650 Rincon	03-06	DAT05855	14,26		
TRX 680 Rincon	03-15	DAT05855	14,26		
TRX 700 XX	08-09	DAT05856	20,20	DAT05853	21,20

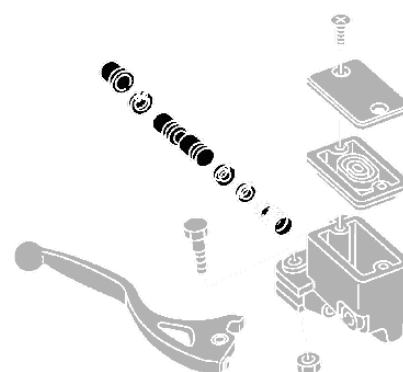

DAT05864

KAWASAKI	Año	DELANTERO		TRASERO	
		Referencia	P.V.P.	Referencia	P.V.P.
KSF 250	87-04	DAT05861	17,95	DAT05853	21,20
KEF 300 LAKOTA	95-03	DAT05861	17,95	DAT05853	21,20
KLF 300B Bayou	88-04	DAT05861	17,95		
KLF 300C Bayou	89-05	DAT05861	17,95		
KVF 300 Prairie	99-02	DAT05861	17,95		
KVF 360 Prairie	03-13	DAT05861	17,95		
KVF 360B Prairie	03-10	DAT05861	17,95		
KLF 400 Bayou	93-99	DAT05861	17,95		
KVF 400 Prairie	97-98	DAT05861	17,95		
KVF 400 Prairie	99-02	DAT05861	17,95		
KFX 400	03-06	DMX05621	20,86		
KFX 450 R	08-14	DAT05857		DAT05853	21,20
KVF 650 Brute Force	05-13	DAT05861	17,95		
KVF 650 Brute Force	06-13	DAT05858			
KVF 650 Prairie	02-03	DAT05861	17,95		
KFX 700 V-Force	04-09	DAT05861	17,95		
KVF 700 Prairie	04-06	DAT05861	17,95		
KVF 750 Brute Force	05-16	DAT05858			



DAT05864

SUZUKI	Año	DELANTERO		TRASERO	
		Referencia	P.V.P.	Referencia	P.V.P.
LT-250 R Quadracer	85-92	DMX05621	20,86	DAT05853	21,20
LT-Z 250 Quadracer	04-09	DMX05621	20,86		
LT-Z 400 Quadracer	03-13	DMX05621	20,86		
LT-R 450 Quadracer	06-09	DMX05621	20,86	DAT05853	21,20
LT 500 R Quadracer	87-90	DMX05621	20,86	DAT05853	21,20
LT-A 500 Vinson	02-07			DAT05853	21,20
LT-F 500 Vinson	03-07			DAT05853	21,20

YAMAHA	Año	DELANTERO		TRASERO	
		Referencia	P.V.P.	Referencia	P.V.P.
YFM 125 Raptor	11-13	DAT05863	17,69	DAT05865	
YSF 200 Blaster	03-06	DAT05864	20,20		
YFM 250 Beartracker	2001	DAT05881	13,07		
YFM 250 Raptor	08-13	DAT05863	17,69	DAT05865	
YFM 350 Wolverine	95-01	DAT05881	13,07		
YFM 350 Big Bear	87-98	DAT05881	13,07		
YFM 350 Big Bear	1999	DAT05882	17,69		
YFM 350 Warrior	90-01	DAT05881	13,07	DAT05883	21,20
YFM 350 Warrior	02-04	DAT05864	20,20		
YFZ 350 Banshee	88-01	DAT05881	13,07	DAT05884	18,48
YFZ 350 Banshee	02-06	DAT05864	20,20	DAT05866	24,29
YFM 350 Raptor	05-13	DAT05864	20,20	DAT05866	24,29
YFM 400 Big Bear	00-01	DAT05881	13,07		
YFM 400 Kodiak	93-98	DAT05881	13,07		
YFM 400 Kodiak	1999	DAT05882	17,69		
YFM 400 Kodiak	00-01	DAT05881	13,07		
YFZ 450	04-06	DAT05864	20,20	DAT05865	
YFZ 450	07-13	DAT05863	17,69	DAT05865	
YFZ 450 R	09-16	DAT05863	17,69	DAT05865	
YFM 550 Grizzly	09-11	DAT05863	17,69	DAT05864	20,20
YFM 600 Grizzly	98-01	DAT05882	17,69		
YFM 660 Raptor	01-05	DAT05864	20,20	DAT05865	
YFM 700 Grizzly	07-11	DAT05864	20,20	DAT05864	20,20
YFM 700 R Raptor	07-16	DAT05863	17,69	DAT05865	

TRANSMISIÓN



Piñón, corona y kit de transmisión

XPEED



HONDA	DESARROLLO ORIGEN			PIÑÓN DE ACERO			CORONA DE ACERO			KIT TRANSMISIÓN 520 ORM	
	Año	Origen	Cadena	Dientes	Referencia	P.V.P.	Dientes	Referencia	P.V.P.	Referencia	P.V.P.
TRX 300 EX	93-08	13 x 38	520/86	13	L055113	9,00	38	L101138	18,00		
TRX 400 EX	99-04	15 x 38	520/92	15	RH070F15	12,00	38	L101138	18,00	L01400	79,04
TRX 400 EX	05-08	14 x 38	520/98	14 15	RH080F14 RH080F15	12,00 12,00	38	L101138	18,00	L01401	81,96
TRX 450 R	04-05	14 x 38	520/94	13 14 15	L152213 L152214 L152215	12,00 12,00 12,00	37 38 39	L101137 L101138 RH060R39	18,00 18,00 18,00	L01450	80,01
TRX 450 R	06-08	13 x 38	520/96	13 14 15	L152213 L152214 L152215	12,00 12,00 12,00	37 38 39	L101137 L101138 RH060R39	18,00 18,00 18,00	L01451	80,99

KAWASAKI	DESARROLLO ORIGEN			PIÑÓN DE ACERO			CORONA DE ACERO			KIT TRANSMISIÓN 520 ORM	
	Año	Origen	Cadena	Dientes	Referencia	P.V.P.	Dientes	Referencia	P.V.P.	Referencia	P.V.P.
KFX 400	03-06	14 x 40	520/112	13 14 15	L160413 L160414 DAT53715	12,00 12,00 12,00	40	L112540	18,00	L02400	80,99

SUZUKI	DESARROLLO ORIGEN			PIÑÓN DE ACERO			CORONA DE ACERO			KIT TRANSMISIÓN 520 ORM	
	Año	Origen	Cadena	Dientes	Referencia	P.V.P.	Dientes	Referencia	P.V.P.	Referencia	P.V.P.
LT 50	84-05	11 x 37		11	L160311	9,00	37	L112637	18,00		
LT 80	87-06	10 x 22	520/36	10	L160510	9,00	22	L112422	18,00		
LT-Z 400	03-08	14 x 40	520/96	13 14 15	L160413 L160414 DAT53715	12,00 12,00 12,00	40	L112540	18,00	L02400	80,99
LT-Z 400	09-12	14 x 38	520/96	13 14	L160413 L160414	12,00 12,00	38				
LT-R 450	06-09	14 x 36	520/96	14 15	RS020F14 DAT53715	12,00 12,00	36	RS020R36	18,00	L02450	80,99

YAMAHA	DESARROLLO ORIGEN			PIÑÓN DE ACERO			CORONA DE ACERO			KIT TRANSMISIÓN 520 ORM	
	Año	Origen	Cadena	Dientes	Referencia	P.V.P.	Dientes	Referencia	P.V.P.	Referencia	P.V.P.
YFA 125 Breeze YFM 125 Grizzly	91-03 04-13	12 x 32	520/74	12 13 14	L166212 L085713 L085714	9,00 9,00 9,00	32	L119932	18,00	L03125	64,73
YFS 200 Blaster	89-05	13 x 40	520/92	12 13 14	L089612 L089613 L089614	9,00 9,00 9,00	40	L120040	18,00	L03200	76,04
YFM 350 Warrior	89-03	13 x 40	520/98	12 13 14 15 16 17	L166212 L085713 L085714 L085715 L085716 L085717	9,00 9,00 9,00 9,00 9,00 9,00	40	L120040	18,00	L03350	78,96
YFM 350 R	04-13	13 x 38	520/98	12 13 14 15	L166212 L085713 L085714 L085715	9,00 9,00 9,00 9,00	38	DAT26538	18,00	L03352	78,96
YFZ 350 Banshee	89-05	14 x 41	520/104	13 14 15 16 17	L085713 L085714 L085715 L085716 L085717	9,00 9,00 9,00 9,00 9,00	40	L120040	18,00	L03351	81,89
YFZ 450	03-13	14 x 38	520/96	13 14 15	L167513 L167514 L167515	9,00 9,00 9,00	38	DAT26538	18,00	L03450	77,99
YFM 660 R Raptor	01-05	13 x 40	520/92	12 13 14 15	L085412 L085413 L085414 L085415	9,00 9,00 9,00 9,00	40	L120040	18,00	L03660	76,04
YFM 700 Raptor	06-13	14 x 38	520/98	14 15	DAT0304714 RY030F15	12,00 12,00	38	DAT26538	18,00	L03700	81,96

PSYCHIC Rodillos cadena

Referencia	Tipo	A	B	C	P.V.P.
DMC030394	**	32	6	29	5,61
DMC030397	**	32	8	29	6,75
DMC030395	**	42	6	29	6,75
DMC030398	**	42	8	29	6,87
DMC030396	*	35	8	19	6,98
DMC030399	**	39	8	23	7,56

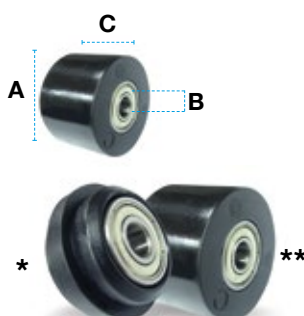

XPEED Mini cortacadenas

Referencia	P.V.P.
E84-56430	23,16





Cadenas

La cadena se sirve con enganche de clip.



Eslabones	REFORZADA 420		REFORZADA 428		REFORZADA 428 OR CON RETENES "O"		SUPER REFORZADA 520H		SUPER REFORZADA 520 ORM CON RETENES "O"		SUPER REFORZADA 520 ATV CON RETENES "X"	
	Ref.	P.V.P.	Ref.	P.V.P.	Ref.	P.V.P.	Ref.	P.V.P.	Ref.	P.V.P.	Ref.	P.V.P.
36							Z52036	16,15	Z53036	21,75		
64	Z42064	14,10										
74							Z52074	27,52	Z53074	37,73		
78							Z52078	28,71	Z53078	40,27		
86							Z52086	31,11	Z53086	46,12		
90			Z43090	23,96	Z44090	33,09	Z52090	32,30	Z53090	48,07		
92							Z52092	32,90	Z53092	49,04		
94							Z52094	33,50	Z53094	50,01		
96							Z52096	34,10	Z53096	50,99	Z56096	92,13
98							Z52098	34,70	Z53098	51,96	Z56098	94,05
100			Z43100	26,18	Z44100	36,43	Z52100	35,29	Z53100	52,94		
104							Z52104	36,49	Z53104	54,89		
130	Z42130	28,99										
Remache	Z42001	1,20	Z43001	1,20	Z44001	1,74	Z52001	1,44	Z53001	1,84	Z56001	2,70
Clip	Z42002	1,32	Z43002	1,50	Z44002	1,82	Z52002	2,04	Z53002	2,42	Z56002	4,05
Características técnicas												
Rotura	22000	kN	23000	kN	23400	kN	36800	kN	34000	kN	36400	kN
Hasta	110cc		150cc		425cc		675cc		700cc		750cc	

XPEED Ejes de tracción super reforzados

Los ejes aumentan la anchura trasera en un mínimo de 2cm y un máximo de 10cm variable, según modelo. Para el LTR 450 sólo aumenta 2 cm. Todos los ejes están garantizados de por vida contra roturas. Los ejes para LTZ incluyen la cruceta para la corona.



2010
DAKAR
Clasificado:
3º J.M. Gonzalez
"Pedregà"

P.V.P
339,37

P.V.P
387,30

ARTIC CAT	Año	Eje	Tuerca eje
DVX 400	05-07	R732002	R733002
HONDA	Año	Eje	Tuerca eje
TRX 450R	04-06	R732007	
KAWASAKI	Año	Eje	Tuerca eje
KFX 400	03-06	R732002	R733002
KYMCO	Año	Eje	Tuerca eje
KXR 250		R732004	R733006

SUZUKI	Año	Eje	Tuerca eje
LTZ 400	03-08	R732002	R733002
LTR 450		R732008	R733002
YAMAHA	Año	Eje	Tuerca eje
YFS 200 Blaster	88-06	R732009	R733001
YFZ 350 Banshee	88-08	R732009	R733001
YFM 350 Raptor	05-09	R732003	R733001
YFZ 450	04-08	R732006	R733006
YFM 660R Raptor	01-05	R732001	R733001
YFM 700R Raptor	06-10	R732005	R733006

XPEED Cruceta de sujeción corona

HONDA	Año	Referencia
TRX 450 R	04-06	R732107
YAMAHA	Año	Referencia
YFM 700 Raptor	06-15	R732105

P.V.P
98



Referencia	Descripción	P.V.P.	Referencia	Descripción	P.V.P.
R730001	Kit 2 tuercas para eje Xpeed	8,42	R730005	Kit casquillos para eje Xpeed	7,60



P.V.P
35

XPEED Tuerca central eje



Correas variador ATV

La tecnología ULTIMAX alarga la vida a las correas y transmite mejor la potencia.



ARGO	Año	Ref. Original	Ref. Impnesa	P.V.P.
Avenger 8X8	05-12	127-137	UA428	60,06

ARTIC CAT	Año	Ref. Original	Ref. Impnesa	P.V.P.
360	08-11	0823-228	UA450	96,36
400	03-08	3402-664	UA400	90,09
400 TRV	13-14	0823-228	UA459	
425	2012	0823-228	UA450	96,36
450	11-12	0823-228	UA450	96,36
500	03-09	3402-757	UA401	90,09
500 TRV	13-14	0823-228	UA459	
500 Prowler	2014	0823-228	UA459	
550 HI	09-12	0823-013	UA406	105,11
550 TRV	09-14	0823-013	UA406	105,11
550 Prowler	09-14	0823-013	UA406	105,11
650 V-TWIN	04-06	3201-242	UA450	96,36
650 HI	05-12	0823-013	UA406	105,11
650 Prowler	06-10	0823-013	UA406	105,11
700	2008	3403-141	UA401	90,09
700	09-14	0823-013	UA406	105,11
700 Prowler	08-14	0823-013	UA406	105,11
1000 TRV H2 EFI Cruiser	09-11	0823-231	UA445	121,49
1000 Thundercat	09-12	0823-231	UA445	121,49
1000 Prowler XTZ	09-14	0823-231	UA445	121,49
1000 Wild Cat	2013	0823-231	UA445	121,49
1000 Wild Cat	2014	0823-391	UA461	

CAN AM	Año	Ref. Original	Ref. Impnesa	P.V.P.
Outlander 400	03-14	715-900-024	UA435	90,09
Renegade 500	2008	715-900-030	UA419	105,11
Renegade 500	09-14	715-000-302	UA446	122,85
Outlander 500	07-08	715-900-030	UA419	105,11
Outlander 500	09-14	715-000-302	UA446	122,85
Outlander 650	06-08	715-900-030	UA419	105,11
Outlander 650	09-14	715-000-302	UA446	122,85
Commander 800	11-14	715-000-302	UA446	122,85
Renegade 800	2008	715-900-030	UA419	105,11
Renegade 800	09-14	715-000-302	UA446	122,85
Outlander 800	06-08	715-900-030	UA419	105,11
Outlander 800	09-14	715-000-302	UA446	122,85
Commander 1000	2011	715-000-302	UA446	122,85
Maverik 1000	2014	715-000-302	UA446	122,85
Renegade 1000	12-14	715-000-302	UA446	122,85
Outlander 1000	12-14	715-000-302	UA446	122,85

KAWASAKI	Año	Ref. Original	Ref. Impnesa	P.V.P.
Brute Force 300	12-14	59011-Y003	UA452	101,05
Praire 360	03-04	59011-1084	UA407	105,11
Praire 360	05-13	59011-0003	UA450	96,36
Praire 650	02-03	59011-0003	UA450	96,36
Brute Force 650	05-13	59011-0003	UA450	96,36
Brute Force 650i	08-13	59011-0003	UA450	96,36
KFX 700 V Force	04-10	59011-0003	UA450	96,36
Brute Force 750	05-12	59011-0003	UA450	96,36
Brute Force 750i	07-14	59011-0003	UA450	96,36
Teryx 750	08-14	59011-0019	UA450	96,36
Teryx 750 "4"	12-14	59011-0033	UA458	

POLARIS	Año	Ref. Original	Ref. Impnesa	P.V.P.
Phoenix 200	05-14	0452496	UA453	77,09
Trail Blazer 250	00-06	3211077	UA412	75,08
Hawkeye 300	2009	3211131	UA440	73,74
Sportsman 300	2009	321131	UA440	73,74
Trail Blazer 330	08-13	3211077	UA412	75,08
Trail Boss 330	03-13	3211077	UA412	75,08
Magnum 330 2X4,4X4	03-06	3211077	UA412	75,08
Sportsman 400	2009	3211131	UA440	73,74
Sportsman 400 HO	12-14	3211077	UA412	75,08
Scrambler 400	00-02	3211069	UA413	75,08

Scrambler 500	00-13	3211077	UA412	75,08
Hawkeye	06-07	3211108	UA427	75,08
ATP 500 H.O.	04-05	3211069	UA413	75,08
Sportsman 6x6	00-07	3211077	UA412	75,08
Sportsman 500 HO	2001	3211077	UA412	75,08
Sportsman 500 HO	03-04	3211069	UA413	75,08
Sportsman 500 HO	2005	3211095	UA413	75,08
Sportsman 500 EFI	2006	3211091	UA413	75,08
Sportsman 500 HO	06-12	3211077	UA412	75,08
Sportsman 500 EFI	07-12	3211113	UA426	90,09
Sportsman 550 XP EFI	09-14	3211123	UA448	122,85
Sportsman 570	2014	3211113	UA426	90,09
Sportsman 600 Twin	03-05	3211091	UA413	75,08
Sportsman 700	02-06	3211091	UA413	75,08
Sportsman 700	07	3211116	UA426	90,09
Sportsman 800 Twin EFI	05-06	3211106	UA424	105,11
Sportsman 800	07-14	3211113	UA426	90,09
Scrambler 850	13-14	3211123/30/60	UA448	122,85
Sportsman 850 XP EFI	09-14	3211123	UA448	122,85
Ranger 500	06-09	3211077	UA412	75,08
Ranger 700	06-09	3211118	UA424	105,11
Ranger 800	10-14	3211118	UA424	105,11
Ranger 900	2014	3211142/8	UA441	137,37
RZR 800	08-14	3211113	UA426	90,09
RZR 4 800	11-14	3211133	UA424	105,11
RZR 800 "S"	10-14	3211133	UA424	105,11
RZR 800 XP	2012	3211136	UA456	137,47
RZR 900 XP	11-14	3211142/8	UA441	137,47
RZR 900 XP "4"	12-14	3211142/8	UA441	137,47
RZR 1000 XP	2014	3211142/8	UA441	137,47
RZR 1000 XP "4"	2014	3211142/8	UA441	137,47

SUZUKI	Año	Ref. Original	Ref. Impnesa	P.V.P.
LTF 400 Eiger	02-07	27601-38F00	UA400	90,09
LTA 400 King Quad	08-13	27601-38F00	UA400	90,09
LTA 450 King Quad	07-13	27601-11H00	UA443	111,93
LTA 500 Vinson 06-07	02-07	27601-09F60	UA401	90,09
LTA 500 King Quad	09-13	27601-11H00	UA443	111,93
LTV 700 Twin Peaks	04-05	K5901-10003	UA450	96,36
LTA 700 King Quad	05-07	27601-31G00	UA437	105,11
LTA 750 King Quad	08-13	27601-31G00	UA437	105,11

YAMAHA	Año	Ref. Original	Ref. Impnesa	P.V.P.
YFM 125 Breeze	89-04	3FA-17641-00	UA425	105,11
YFM 125 Grizzly	04-13	3FA-17641-00	UA425	105,11
YFM 300 Grizzly	12-13	1SC-E7641-00	UA452	101,05
YFM 350 Bruin	04-06	5UH-17641-00	UA416	105,11
YFM 350 Grizzly	07-15	5UH-17641-00	UA416	105,11
YFM 350 Wolverine	05-08	5UH-17641-00	UA416	105,11
YFM 400 Kodiak	00-06	5GH-17641-00	UA417	90,09
YFM 400 Grizzly	07-14	5GH-17641-00	UA417	90,09
YFM 450 Wolverine	05-09	5GH-17641-00	UA417	90,09
YFM 450 Grizzly	07-15	5GH-17641-00	UA417	90,09
YFM 450 Kodiak	01-06	5GH-17641-00	UA417	90,09
YXR 450 Rhino	06-08	5GH-17641-00	UA417	90,09
YFM 550 Grizzly	11-15	28P-17641-00	UA422	105,11
YFM 600 Grizzly	98-01	4WV-17641-00	UA423	105,11
YFM 660 Grizzly	02-08	5KM-17641-00	UA422	105,11
YFM 700 Grizzly	07-15	3B4-17641-00	UA422	105,11
YXR 660 Rhino	05-08	5KM-17641-00	UA422	105,11
YXR 700 Rhino	08-13	5B4-17641-00	UA438	105,11
YXR 700 Viking	14-15	1XD-17641-00	UA464	
YXR 700 Viking VI	14-15	1XD-17641-00	UA464	

BRONCO Rodillos variador

SUZUKI	Año	Descripción	Referencia
LT-A 450 King Quad	08-10	8 rodillos 30mm x 18mm 25g.	DAT034201
LT-A 500 King Quad	11-13	8 rodillos 30mm x 18mm 25g.	DAT034201
LT-A 500 Quad Master	00-01	8 rodillos 30mm x 18mm 25g.	DAT034201
LT-A 500 Vinson	02-07	8 rodillos 30mm x 18mm 25g.	DAT034201
YAMAHA	Año	Descripción	Referencia
YFM 350 Bruin	04-06	8 rodillos 30mm x 15mm 21g.	DAT034103
YFM 350 Grizzly	07-14	8 rodillos 30mm x 15mm 21g.	DAT034103
YFM 350 Wolverine	06-09	8 rodillos 30mm x 15mm 21g.	DAT034103
YFM 400 Grizzly	07-08	8 rodillos 30mm x 15mm 15g.	DAT034102
YFM 400 Kodiak	00-06	8 rodillos 30mm x 15mm 15g.	DAT034102
YFM 450 Grizzly	07-14	8 rodillos 30mm x 15mm 15g.	DAT034102
YFM 450 Kodiak	03-06	8 rodillos 30mm x 15mm 15g.	DAT034102
YFM 450 Wolverine	06-11	8 rodillos 30mm x 15mm 15g.	DAT034102
YXR 450 Rhino	06-09	8 rodillos 30mm x 15mm 15g.	DAT034102
YFM 550 Grizzly	09-14	8 rodillos 30mm x 15mm 21g.	DAT034103
YFM 600 Grizzly	98-01	8 rodillos 30mm x 15mm 21g.	DAT034103
YFM 660 Grizzly	02-08	8 rodillos 30mm x 15mm 18g.	DAT034101
YXR 660 Rhino	03-07	8 rodillos 30mm x 15mm 18g.	DAT034101
YFM 700 Grizzly	07-14	8 rodillos 30mm x 15mm 21g.	DAT03410
YXE 700 Wolverine	2016	8 rodillos 30mm x 15mm 21g.	DAT03410
YXM 700 Viking	14-16	8 rodillos 30mm x 15mm 21g.	DAT03410
YXR 700 Rhino	08-13	8 rodillos 30mm x 15mm 20g.	DAT034104

P.V.P
24,95



RUEDAS Y NEUMÁTICOS

MOTOR

ADMISIÓN / ESCAPE
REFRIGERACIÓN

ELECTRICO

SUSPENSIÓN / DIRECCIÓN

FRENOS

TRANSMISIÓN

CONTROLES Y MANDOS

CHASIS

ACCESORIOS

BRONCO

Pastillas de variador Polaris

Referencia: DAT03129 P.V.P. 26,00 (10 unidades)
Ref. Original: 5431936, 5439254
Descripción: exterior Ø13,91/14,1 mm, ancho 6,3 mm

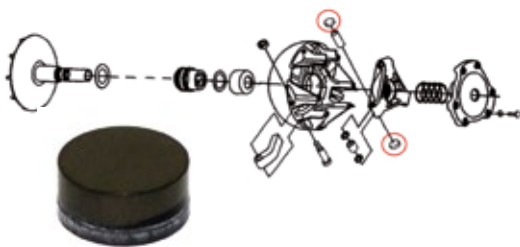

BRONCO

Casquillo variador

Referencia: DAT03128 P.V.P. 5,28
Ref. Original: 5020795
Descripción: exterior Ø9,5 mm, interior Ø6,5 mm, ancho 25,4 mm

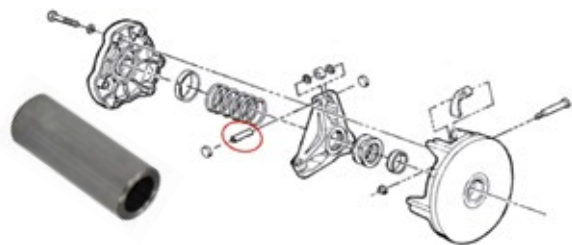

BRONCO Rodillos embrague

Referencia: DAT03130 P.V.P. 5,32
Ref. Original: 1321977
Descripción: exterior Ø19,6/21,5 mm, interior Ø6,8 mm, ancho 19,15 mm



Referencia: DSM03106 P.V.P. 31,36 (2 unidades)
Ref. Original: 3234197 / 3234207 / 5434534
Descripción: exterior Ø23,7 mm, interior Ø9,6 mm, ancho 14 mm



BRONCO Casquillos embrague Polaris

Referencia: DAT03125 P.V.P. 16,48
 Ref. Original: 3585712
 Descripción: exterior Ø62 mm, interior Ø57,4 mm, ancho 25,5 mm

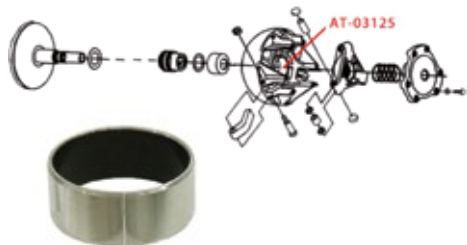

Referencia: DAT03131 P.V.P. 13,65
 Ref. Original: 3585710
 Descripción: exterior Ø58,8 mm, interior Ø54,4 mm, ancho 12,5 mm

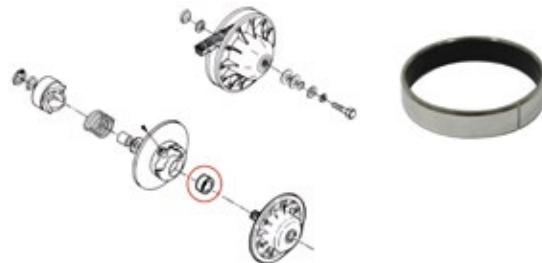

Referencia: DAT03145 P.V.P. 16,00
 Ref. Original: 3514492
 Descripción: exterior Ø49,2 mm, interior Ø44,4 mm, ancho 25,4 mm

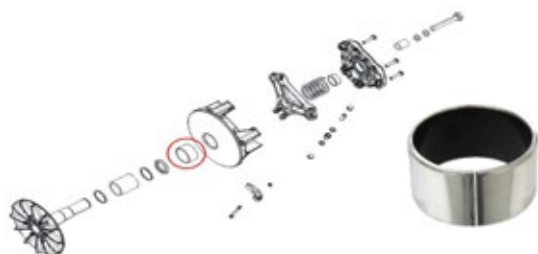

Referencia: DAT03148 P.V.P. 8,85
 Ref. Original: 3514684
 Descripción: exterior Ø32,7 mm, interior Ø28,7 mm, ancho 19,1 mm



Referencia: DAT03149 P.V.P.
 Ref. Original: 5437682
 Descripción: exterior Ø19,5 mm, interior Ø12,2 mm, ancho 12,7 mm

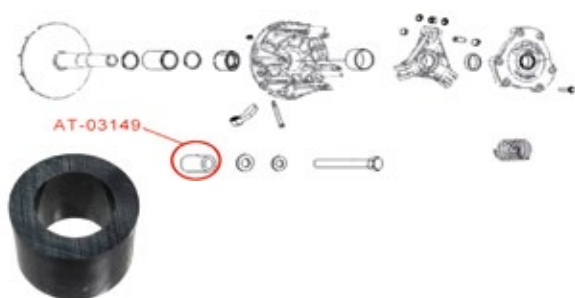

Referencia: DSM03101 P.V.P. 13,65
 Ref. Original: 3576504
 Descripción: exterior Ø42,1 mm, interior Ø38,2 mm, ancho 12,7 mm

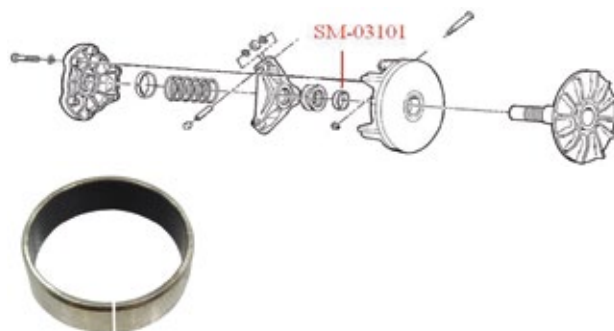

Referencia: DSM03045A P.V.P. 13,65
 Ref. Original: 3576511
 Descripción: exterior Ø42 mm, interior Ø38,2 mm, ancho 25,3 mm

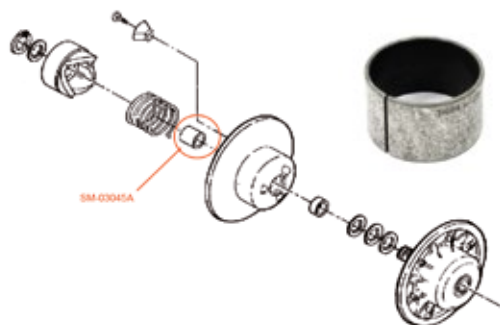

BRONCO

Kit reparación variador Polaris



DAT03418
Rodillos de
14mm de ancho



DAT03419
Rodillos de
9mm de ancho

Referencia	Descripción	P.V.P.
DAT03418	Rodillos de 14 mm de ancho	44,12
DAT03419	Rodillos de 9 mm de ancho	38,93

BRONCO

Guía rampa embrague Polaris

Referencia	Unidades	P.V.P.
D03151040	3	6,00
D03151040T	10	15,50



BRONCO

Kit contrapesos variador

P.V.P
Consultar



DAT03134
Serie 10MHF



DAT03415
Serie 10WHF



DAT03416
Serie 10BH



DAT03417
Serie 25-52

POLARIS	Año	Referencia	Peso	Original
400 Hawkeye	2012	DAT03415	45G(+/-0.2G)	5632283
400 Ranger	10-13	DAT03416	45G(+/-0.2G)	5632401
400 Sportsman	11-13	DAT03415	45G(+/-0.2G)	5632283
450 Sportsman	06-07	DAT03415	45G(+/-0.2G)	5632283
500 Ranger	08-09	DAT03134	50G(+/-0.2G)	5632281
500 Ranger	10-13	DAT03417	52G(+/-0.2G)	5632409
500 Scrambler	98-08	DAT03415	45G(+/-0.2G)	5632283
500 Scrambler	10-12	DAT03417	52G(+/-0.2G)	5632409
500 Sportsman	01-13	DAT03415	45G(+/-0.2G)	5632283
500 Worker	2001	DAT03415	45G(+/-0.2G)	5632283
570 RZR	12-13	DAT03417	52G(+/-0.2G)	5632409

BRONCO

Kit reparación variador

P.V.P
16,48

Referencia: DAT03425

Ref. Original: 417-2232-57 / 417-2232-69 / 417-2233-87 / 417-2237-67 / 420-2812-90 / 420-2812-91 / 420-2812-93 / 420-6262-31 /

CAN AM

Año	
06-14	Outlander 400
07-14	Outlander 500
08-14	Renegade 500
06-14	Outlander 650
12-14	Commander 800
06-14	Outlander 800
07-14	Renegade 800
12-14	Commander 1000
13-14	Maverick 1000



BRONCO

Perno embrague arrancador

Referencia: DAT12670 P.V.P. 19,23€

Ref. Original: 38030023

Descripción: M19 x 18G 3/8", largo 159mm

POLARIS

Año	
09-15	550 Sportsman
08-14	800 RZR
13-15	850 Scrambler
09-15	850 Sportsman



RUEDAS Y NEUMÁTICOS

MOTOR

ADMISIÓN / ESCAPE
REFRIGERACIÓN

ELECTRICO

SUSPENSIÓN / DIRECCIÓN

FRENOS

TRANSMISIÓN

CONTROLES Y MANDOS

CHASIS

ACCESORIOS



Recambios variadores J.Costa

Recomendamos un mantenimiento cada 8.000km para los vehículos que tengan una utilización normal. Se debe verificar estado de masas y casquillo. Es conveniente verificar la holgura del casquillo, la no sustitución del casquillo con holgura ocasionará un desgaste muy prematuro a todos los componentes.



		MASAS		CASQUILLO		BULON		CAMPANA	
AXR	Año	Referencia	P.V.P.	Referencia	P.V.P.	Referencia	P.V.P.	Referencia	P.V.P.
Crossbone 400		JCD20014M	30,00	JC383038	20,00	JC625S		JC803C	30,00
CFMOTO	Año	Referencia	P.V.P.	Referencia	P.V.P.	Referencia	P.V.P.	Referencia	P.V.P.
Buggy 500		JCJ23516M	35,00	JC453547	35,00	ORIGEN		JC806C	30,00
KYMCO	Año	Referencia	P.V.P.	Referencia	P.V.P.	Referencia	P.V.P.	Referencia	P.V.P.
Mxer 150		JCA08512M	25,00	JC332525WRS	14,00	JC611S	12,50	JC611C	30,00
Maxxer 250		JCD12514M	30,00	JC383038	20,00	JC701S	15,00	JC701C	30,00
Mongoos 250		JCD12514M	30,00	JC383038	20,00	JC701S	15,00	JC701C	30,00
MXU 250		JCD12514M	30,00	JC383038	20,00	JC701S	15,00	JC701C	30,00
MXU 300		JCD13514M	30,00	JC383038	20,00	JC701S	15,00	JC701C	30,00
MXU 500		JCJ21016M	35,00	JC504255	50,00	ORIGEN		JC705C	36,00
PGO	Año	Referencia	P.V.P.	Referencia	P.V.P.	Referencia	P.V.P.	Referencia	P.V.P.
Buggy 250									
Buggy 500		JCD20014M	30,00	JC383038	20,00	JC625S		JC625C	30,00
XILING	Año	Referencia	P.V.P.	Referencia	P.V.P.	Referencia	P.V.P.	Referencia	P.V.P.
Buggy 250		JCD10514M	30,00	JC383038	20,00	JC613S	15,00	JC801C	30,00
YAMAHA	Año	Referencia	P.V.P.	Referencia	P.V.P.	Referencia	P.V.P.	Referencia	P.V.P.
YFM 660 Grizzly	02-08	JCJ21016M	35,00	JC453555		ORIGEN		JC714C	36,00
YFM 660 Rhino	04-07	JCJ21016M	35,00	JC453555		ORIGEN		JC714C	36,00
YFM 700 Grizzly	07-15	JCJ22016M	35,00	JC453555		ORIGEN		JC714C	36,00
YFM 700 Rhino	08-13	JCJ22016M	35,00	JC453555		ORIGEN		JC714C	36,00

J.COSTA Variadores J.Costa

Los variadores J.Costa ofrecen mayores prestaciones y suavidad en conducción, mejorando la recuperación y ofreciendo un mayor tacto en la desaceleración.

El modelo Urban mejora prestaciones. El modelo Urban EVO 3 mejora prestaciones y consumos.

Es esencial montar los variadores utilizando una llave dinamométrica para su correcta instalación, con el par de apriete recomendado por el fabricante (**un par de apriete distinto al recomendado ocasionará graves daños en el embrague y en el cigüeñal**)



	URBAN			URBAN EVO 3		
AXR	Año	Referencia	P.V.P.	Referencia	P.V.P.	Par de apriete
Crossbone 400		JC803B	250,00			10,5 Kg.
CFMOTO	Año	Referencia	P.V.P.	Referencia	P.V.P.	Par de apriete
Buggy 500		JC806B	375,00			16 Kg.
KYMCO	Año	Referencia	P.V.P.	Referencia	P.V.P.	Par de apriete
Mxer 150		JC702Q	200,00			9,3 Kg.
Maxxer 250				JC701Q	200,00	10 Kg.
Mongoos 250				JC701Q	200,00	10 Kg.
MXU 250				JC701Q	200,00	10 Kg.
MXU 300		JC703Q	200,00			10 Kg.
MXU 500		JC705Q	375,00			13,8 Kg.
PGO	Año	Referencia	P.V.P.	Referencia	P.V.P.	Par de apriete
Buggy 250				JC804B	200,00	9,3 Kg.
Buggy 500				JC805B	250,00	16 Kg.
XILING	Año	Referencia	P.V.P.	Referencia	P.V.P.	Par de apriete
Buggy 250		JC801B	250,00			8 Kg.
YAMAHA	Año	Referencia	P.V.P.	Referencia	P.V.P.	Par de apriete
YFM 660 Grizzly	02-08	JC713Q	375,00			16 Kg.
YFM 660 Rhino	04-07	JC713Q	375,00			16 Kg.
YFM 700 Grizzly	07-15	JC714Q	375,00			16 Kg.
YFM 700 Rhino	08-13	JC714Q	375,00			16 Kg.



Variador original

Los rodillos son empujados al exterior del variador, a consecuencia de la inercia en la aceleración, y caen a plomo en la desaceleración.

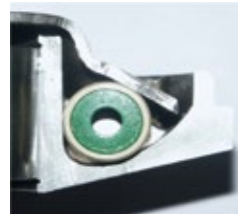

Original cerrado



Original abierto

Variador J. Costa

Las masas son empujadas al exterior del variador, a consecuencia de la inercia en la aceleración, pero se repliegan paulatinamente en la desaceleración, consecuentemente al acelerar entre regímenes la recuperación es mucho más rápida.

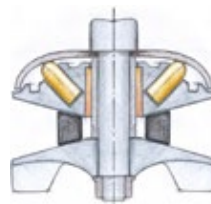

J.Costa cerrado

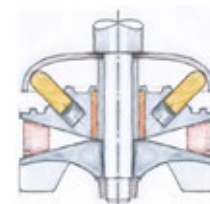

J.Costa abierto

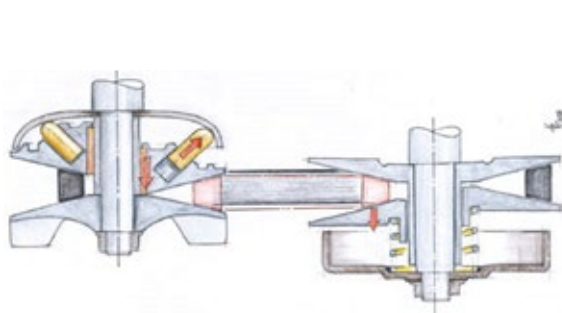

Arandela de grueso (solo en algunos modelos)

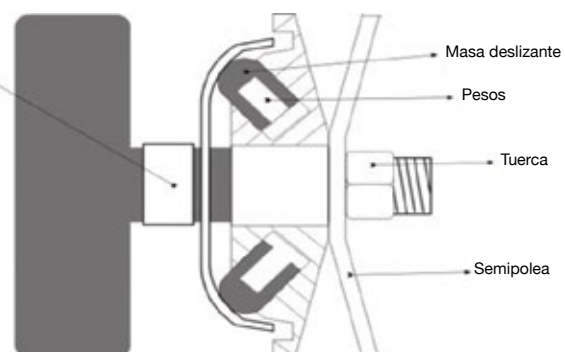

Masa deslizante
Pesos
Tuerca
Semipolea

RUEDAS Y NEUMÁTICOS

MOTOR

ADMISIÓN / ESCAPE
REFRIGERACIÓN

ELÉCTRICO

SUSPENSIÓN / DIRECCIÓN

FRENOS

TRANSMISIÓN

CONTROLES Y MANDOS

CHASIS

ACCESORIOS

BRONCO Crucetas cardan

P.V.P
22

ARTIC CAT	Año	Posición	Referencia	Posición	Referencia
250	01-05	4	DAT08514		
300	98-05	4	DAT08514		
375	2002	4	DAT08514		
400	2002	4	DAT08514		
400	2001	3 4	DAT08514		
400	98-00	4	DAT08514		
400	03-04	4	DAT08515		
400 FIS	2002	4	DAT08514		
400 FIS	03-08	4	DAT08515		
400 TBX	04-06	4	DAT08515		
400 TRV	07-13	4	DAT08515		
400 VP	05-06	3 4	DAT08515		
450 EFI	2012	4	DAT08515		
450 H1	10-11	4	DAT08515		
400 TRV	2012	4	DAT08515		
454 4x4	96-98	4	DAT08514		
500	98-99	4	DAT08514		
500	00-02	3 4	DAT08514		
500 EFI	2013	3	DAT08515		
500 FIS	2002	3	DAT08514		
500 FIS	03-09	3	DAT08515		
500 TBX FIS	2002	3 6	DAT08514		
500 TBX FIS	03-06	3	DAT08514		
500 TRV FIS	03-08	3	DAT08515		
500 TRV	2013	3	DAT08515		
500 XT	2013	3	DAT08515		
550 EFI	12-13	3	DAT08515		
550 GT	2012	3	DAT08515		
550 FIS	09-11	3	DAT08515		
550 TRV	09-11	3	DAT08515		
550 TRV	2012	3	DAT08515		
550 TRV	2013	3	DAT08515		
550 XT	2013	3	DAT08515		
650 H1	05-11	4	DAT08515		
650 Mud Pro	10-11	4	DAT08515		
650 Prowler XT	2006	3 4	DAT08515	5 6	DAT08509
650 Prowler XT	07-09	5 6	DAT08509	6	
650 V2	04-06	3 4	DAT08515	5 6	DAT08509
700 Diesel	08-13	4	DAT08515		
700 EFI Auto	07-08	3 4	DAT08515		
700 EFI	09-12	3	DAT08515		
700 GT	2012	4	DAT08515		
700 H1	08-11	4	DAT08515		
700 LTD	2013	3	DAT08515		
700 Mud Pro	09-11	4	DAT08515		
700 Mud Pro	12-13	3	DAT08515		
700 TRV	2008	3 4	DAT08515		
700 TRV	09-11	3	DAT08515		
700 TRV	2012	3	DAT08515		
700 XT	2013	3 4 5 6	DAT08515		
1000 Cruiser	2012	3 4 5 6	DAT08514		
1000 GT	2012	3 4 5 6	DAT08514		
1000 Thunder Cat	2008	3 4	DAT08515		
1000 Thunder Cat	09-11	3 4 5 6	DAT08514		
1000 Mud Pro	10-13	3 4 5 6	DAT08514		
1000 TRV	12-13	3 4 5 6	DAT08514		
1000 Prowler	2009	3 4 5 6	DAT08514		
1000 Prowler	10-13	3 4	DAT08514		

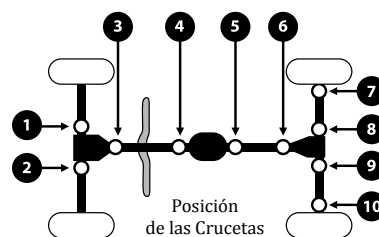

CAN AM	Año	Posición	Referencia	Posición	Referencia
330 Outlander	04-05	5 6	DAT08532		
400 Outlander	03-15	5 6	DAT08532		
500 Outlander	07-15	4	DAT08532	5 6	DAT08533
500 Quest	02-03	3 4 5	DAT08532		
500 Quest	2004	5	DAT08532		
500 Renegade	08-12	4	DAT08532	5 6	DAT08533
500 Renegade	13-15	5 6	DAT08533		

500 Traxter	99-04	3 4 5	DAT08532		
650 Outlander	06-12	4	DAT08532	5 6	DAT08533
650 Outlander	13-15	5 6	DAT08533		
650 Quest	02-03	3 4	DAT08532	5	DAT08533
650 Quest	2004	5	DAT08533		
800 Commander	11-13	3 4	DAT08532	5 6	DAT08533
800 Commander	14-15	5 6	DAT08533		
800 Outlander	06-11	4	DAT08532	5 6	DAT08533
800 Outlander	12-15	5 6	DAT08533		
800 Renegade	07-11	4	DAT08532	5 6	DAT08533
800 Renegade	12-15	5 6	DAT08533		
1000 Commander	11-14	3 4	DAT08532	5 6	DAT08533
1000 Commander	2015	5 6	DAT08533		
1000 Outlander	12-15	5 6	DAT08533		
1000 Renegade	12-15	5 6	DAT08533		
1000 Maverick	13-15	3 4	DAT08532	5	DAT08533

KAWASAKI	Año	Posición	Referencia	Posición	Referencia
KLF 300 Bayou	89-04	3 4	DAT08531		
KVF 300 Prairie 2x4	99-02	6	DAT08513		
KVF 300 Prairie 4x4	99-02	3 4	DAT08535		
KVF 300 Prairie 4x4	03-09	5	DAT08513		
KVF 360 Prairie 2x4	03-09	6	DAT08534		
KVF 360 Prairie 4x4	03-13	5	DAT08534		
KLF 400 Bayou 4x4	93-99	3 4	DAT08535		
KVF 400 Prairie 2x4	98-02	6	DAT08513		
KVF 400 Prairie 4x4	97-02	3 4	DAT08535	5	DAT08513
KVF 650 Prairie	02-03	5	DAT08534		
KVF 650 Brute Force	05-13	5	DAT08534		
KVF 650 i Brute Force	06-13	5 6	DAT08534		
KFX 700 V-Force	04-09	6	DAT08534		
KVF 700 Prairie	04-06	5	DAT08534		
KVF 750i Brute Force	05-15	5 6	DAT08534		
KRT 750 Teryx	08-13	3 4	DAT08513	5 6	DAT08539
610 Mule 4x4 (400cc)	05-13	3 4 5 6	DAT08513		
620 Mule (todos)	94-09	7 8 9 10	DAT08514		
2510 Mule (620cc)	00-02	5 6 6	DAT08513	7 8 9 10	DAT08514
2510 Mule (950cc) diesel	00-02	5 6 6	DAT08513	7 8 9 10	DAT08514
2520 Mule (620cc)	93-09	7 8 9 10	DAT08514		
3000 Mule (620cc)	01-08	7 8 9 10	DAT08514		
3010 Mule (620cc)	01-08	5 6 6	DAT08513	7 8 9 10	DAT08539
3010 Mule (950cc) diesel	01-08	5 6 6	DAT08513	7 8 9 10	DAT08539
3020 Mule (620cc)	01-03	7 8 9 10	DAT08514		
4000 Mule (620cc)	09-15	7 8 9 10	DAT08514		
4010 Mule (620cc)	09-15	5 6 6	DAT08513	7 8 9 10	DAT08539
4010 Mule (950cc) diesel	09-15	5 6 6	DAT08513	7 8 9 10	DAT08539

SUZUKI	Año	Posición	Referencia	Posición	Referencia	Posición	Referencia
LT-A 250 Ozark	02-06	5	DAT08515				
LT-F 250 Quad Runner 2x4	88-94	5 6	DAT08509	7 10	DAT08537	8 9	DAT08536
LT-F 250 Quad Runner 4x4	88-93	3 4	DAT08509	7 10	DAT08537	8 9	DAT08536
LT-F 250 Quad Runner 4x4	88-93	5	DAT08514				
LT-F 250 Quad Runner 4x4	94-00	5	DAT08514	7 10	DAT08537	3 4	DAT08509
LT-F 250 Quad Runner 2x4	2001	3 4	DAT08518	7 10	DAT08537	8 9	DAT08536
LT-F 250 Quad Runner 2x4	2002	3 4	DAT08518				
LT-F 250 Quad Runner 4x4	01-02	5	DAT08515	7 10	DAT08537		
LT-Z 250 Quad Sport	04-06	5	DAT08515				
LT-F 300 Quad Runner 4x4	1994	5	DAT08514	7 10	DAT08538	8 9	DAT08536
LT-F 300 Quad Runner 4x4	1995	5	DAT08514	7 10	DAT08538		
LT-F 300 King Quad 4x4	91-93	8 9	DAT08536	7 10	DAT08538		
LT-F 300 King Quad 4x4	96-98	5	DAT08514	7 10	DAT08538		
LT-F 300 King Quad 4x4	99-00	3 4	DAT08518	7 10	DAT08538	5	DAT08514
LT-F 300 King Quad 4x4	01-02	3 4	DAT08518	7 10	DAT08538	5	DAT08515
LT-A 400 Eiger	02-07	3 5 6	DAT08515				
LT-A 450 King Quad	08-10	3 4	DAT08515				
LT-A 500 King Quad	09-14	3 4	DAT08518				
LT-A 500 Quad Master 4x4	2000	3 5	DAT08514				
LT-A 500 Quad Master 4x4	2001	5 6	DAT08514	3	DAT08515		
LT-A 500 Quad Runner 4x2	98-00	5	DAT08514				
LT-A 500 Quad Runner 4x2	2001	5 6	DAT08515				
LT-A 500 Quad Runner 4x2	2002	3 5 6	DAT08515				

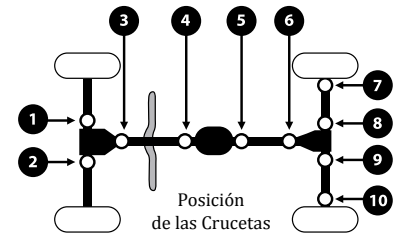

Referencia	A (mm)	B (mm)
DAT08500	20	58,70
DAT08501	25,4	82
DAT08502	27	65,50
DAT08503	23,9	59,50
DAT08507	22	55,60
DAT08509	25	66
DAT08513	22	53,20
DAT08514	25	63,30
DAT08515	20	56,40
DAT08516	20	37
DAT08518	25	65
DAT08532	22	55,35
DAT08533	25	64,70
DAT08534	24	58
DAT08535	20	50,60
DAT08536	32,9	56,60
DAT08537	20	51
DAT08538	31	51
DAT08539		
DAT08573		

BRONCO Crucetas cardan

P.V.P
22

LT-A 500 Quad Runner 4x4	98-02	3 4	DAT08518	5	DAT08509
LT-A 550 King Quad	2012	3 4	DAT08518		
LT-A 700 King Quad	05-07	3 4	DAT08518	6	DAT08509
LT-A 750 King Quad	08-14	3 4	DAT08518		

YAMAHA	Año	Posición	Referencia	Posición	Referencia
YFM 250 Bear Tracker	99-04	5	DAT08509		
YFM 250 Big Bear	07-08	5	DAT08500		
YFM 250 Bruin	2006	5	DAT08500		
YFM 250 Timberwolf 2x4	92-98	5	DAT08509		
YFM 250 Timberwolf 4x4	94-00	3 4	DAT08516	5 6	DAT08509
YFM 350 Big Bear	87-99	3 4	DAT08516	5 6	DAT08509
YFM 350 Grizzly	07-08	5	DAT08500		
YFM 350 Grizzly IRS	07-13	3 4 5 6	DAT08500		
YFM 350 Wolverine	06-08	5	DAT08500		
YFM 350 Wolverine	95-98	3 4	DAT08500	5 6	DAT08509
YFM 400 Big Bear	2006	3 4	DAT08500		
YFM 400 Big Bear	07-12	3 4 5 6	DAT08500		
YFM 400 Grizzly	07-08	3 4 5 6	DAT08500		
YFM 400 Kodiak	93-97	3 4	DAT08516	5 6	DAT08509
YFM 400 Kodiak	98-99	3 4	DAT08500		
YFM 400 Kodiak	05-06	5 6	DAT08500		
YFM 450 Grizzly	09-13	3 4 5 6	DAT08500		
YFM 450 Kodiak	03-06	3 4 5 6	DAT08500		
YFM 450 Rhino	2006	3 4	DAT08500		
YFM 450 Wolverine	07-08	5	DAT08500		
YFM 600 Grizzly	1998	3 4	DAT08516	5 6	DAT08509
YXR 660 Rhino	04-07	3 4	DAT08500		
YXR 700 Rhino	08-03	3 4	DAT08500		

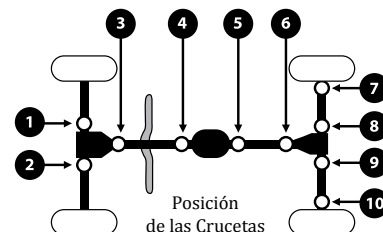

POLARIS	Año	Posición	Referencia	Posición	Referencia	Posición	Referencia	Posición	Referencia
250 4x4	90-93	1 2	DAT08503						
250 Trail Boss	87-92	1 2	DAT08503						
250 Xplorer	00-02	1 2 3 4	DAT08503						
300	1994	1 2	DAT08503						
300	1995	1 2	DAT08507						
300	1996	1 2	DAT08503						
300 Hawkeye	06-07	3 4	DAT08503						
300 Sportsman	08-10	3 4	DAT08503						
300 Xplorer	96-99	1 2	DAT08507						
325 Magnum 2x4	00-02	5	DAT08503						
325 Magnum 4x4	00-02	1 2	DAT08507	3 4 5	DAT08503				
325 Sportsman ACE	14-15	3 4	DAT08495						
325 Xpedition 4x4	00-02	1 2	DAT08507	3 4 5	DAT08503				
330 ATP 4x4	04-05	1 2 3 4	DAT08503	5	DAT08507				
330 Magnum HDS	03-04	5	DAT08507	3 4	DAT08503				
330 Magnum	03-06	5	DAT08507	3 4	DAT08503				
335 Sportsman	99-00	1 2	DAT08507	3 4	DAT08503	8 9	DAT08501	7 10	DAT08502
335 Sportsman ACE	14-15	3 4	DAT08495						
335 Worker	1999	1 2	DAT08507	3 4	DAT08503	8 9	DAT08501	7 10	DAT08502
350L Trail Boss	90-93	1 2	DAT08503						
400 4x4	1994	1 2	DAT08503						
400 Scrambler	95-97	1 2 int.	DAT08503	1 2 ext.	DAT08507				
400 Scrambler	98-02	1 2 int.	DAT08503	1 2 ext.	DAT08507	3 4	DAT08503		
400 Sportsman	93-94	1 2	DAT08503						
400 Sportsman	95-96	1 2 int.	DAT08503	1 2 ext.	DAT08507				
400 Sportsman	1997	1 2	DAT08507						
400 Sportsman	2001	3 4	DAT08503						
400 Sportsman	02-04	1 2 3 4	DAT08503						
400 Sportsman	05-13	3 4	DAT08503						
400 Xplorer	95-96	1 2 int.	DAT08503	1 2 ext.	DAT08507				
400 Xplorer	97-98	1 2	DAT08507						
400 Xplorer	99-02	1 2 3 4	DAT08503						
425 Magnum	95-96	1 2 int.	DAT08503	1 2 ext.	DAT08507				
425 Magnum	97-98	1 2	DAT08507						
425 Xpedition	00-01	1 2	DAT08507	3 4 5	DAT08503				
425 Xpedition	2002	1 2 3 4	DAT08503						
450 Sportsman	06-07	3 4	DAT08503						
455 Diesel	1999	1 2	DAT08507	3 4	DAT08503	8 9	DAT08501	7 10	DAT08502

P.V.P
22

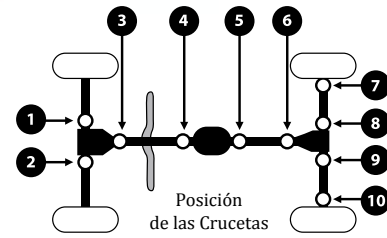

BRONCO Crucetas cardan

455 Diesel	2000	1 2	DAT08507							
455 Diesel	2001	1 2 int.	DAT08503	1 2 ext.	DAT08507	3 4	DAT08503			
500 ATP	2004	1 2 3 4	DAT08503	5	DAT08507					
500 ATP	2005	3 4	DAT08503	5 6	DAT08507					
500 Magnum	99-00	1 2	DAT08507	3 4	DAT08503					
500 Magnum HDS	2001	5	DAT08503							
500 Magnum HDS	2002	3 4 5	DAT08503							
500 Magnum	01-02	1 2	DAT08507	3 4 5	DAT08503					
500 Magnum	2003	3 4	DAT08503	5	DAT08507					
500 Ranger	04-09	3 4 5 6	DAT08503							
500 Ranger	10-12	3 4	DAT08503							
500 Scrambler	1997	1 2	DAT08507							
500 Scrambler	98-06	1 2	DAT08507	3 4	DAT08503					
500 Scrambler	10-12	3 4	DAT08503							
500 Sportsman	1996	1 2 int.	DAT08503	1 2 ext.	DAT08507	8 9	DAT08501	7 10	DAT08502	
500 Sportsman	1997	1 2 3 4	DAT08503	8 9	DAT08501	7 10	DAT08502			
500 Sportsman	1998	1 2	DAT08507	3 4	DAT08503	8 9	DAT08501	7 10	DAT08502	
500 Sportsman	99-01	1 2	DAT08507	3 4	DAT08503					
500 Sportsman HO	2001	1 2	DAT08507	3 4	DAT08503					
500 Sportsman HO	02-03	3 4	DAT08503							
500 Sportsman HO	2004	1 2	DAT08503	3 4 int.	DAT08503	3 4 ext.	DAT08507			
500 Sportsman HO	05-06	3 4	DAT08503							
500 Sportsman EFI	06-07	3 4 5 6	DAT08503							
500 Sportsman X2	06-07	5 6	DAT08503							
500 Sportsman HO	08-13	3 4	DAT08503							
500 Sportsman EFI	09-10	3 4 5 6	DAT08503							
500 Sportsman X2	08-09	3 4 5 6	DAT08503							
500 Worker 4x4	1999	1 2 3 4	DAT08507							
500 Xplorer 4x4	1997	1 2 3 4	DAT08503	8 9	DAT08501	7 10	DAT08502			
550 Sportsman	2011	3 4 5 6	DAT08503							
550 Sportsman	12-13	3 4	DAT08573							
550 Sportsman EFI	2010	3 4 5 6	DAT08503							
550 Sportsman EFI	11-13	3 4	DAT08573	5 6	DAT08503					
550 Sportsman XP	09-11	3 4 5 6	DAT08503	3 4	DAT08573					
550 Sportsman X2	2010	3 4 5 6	DAT08503							
550 Sportsman X2	11-12	5 6	DAT08503	3 4	DAT08573					
570 RZR	12-13	3 4	DAT08503							
570 Sportsman ACE	2015	3 4	DAT08495							
600 Sportsman 4x4	03-04	1 2 3 4 5 6	DAT08503							
600 Sportsman 4x4	2005	3 4 5 6	DAT08503							
700 Ranger TM	04-06	5 6	DAT08503							
700 Ranger EFI	05-09	3 4 5 6	DAT08503							
700 Sportsman	02-04	1 2 3 4 5 6	DAT08503							
700 Sportsman	05-06	3 4 5 6	DAT08503							
700 Sportsman EFI	03-04	1 2 3 4 5 6	DAT08503							
700 Sportsman EFI	05-07	3 4 5 6	DAT08503							
700 Sportsman X2	2008	3 4 5 6	DAT08503							
800 Sportsman EFI	05-13	3 4	DAT08503							
800 Sportsman X2	07-09	3 4 5 6	DAT08503							
800 Sportsman Forest	12-13	3 4 5 6	DAT08503							
850 Sportsman	11-13	3 4	DAT08573							
850 Sportsman Forest	2010	3 4 5 6	DAT08503							
850 Sportsman Forest	11-13	5 6	DAT08503	3 4	DAT08573					
850 Sportsman Touring	2010	3 4 5 6	DAT08503							
850 Sportsman Touring	11-13	5 6	DAT08503	3 4	DAT08573					
850 Sportsman XP	09-10	3 4 5 6	DAT08503							
850 Sportsman XP	11-13	5 6	DAT08503	3 4	DAT08573					
850 Sportsman X2	2010	3 4 5 6	DAT08503							
850 Sportsman X2	2011	5 6	DAT08503	3 4	DAT08573					
900 RZR XP	2010	3 4	DAT08503							
900 RZR XP	11-13	3 4	DAT08573							
900 RZR XP "4"	12-13	3 4	DAT08503							
900 RZR XP	2015	3 4 5 6	DAT08495							

RUEDAS Y NEUMÁTICOS

MOTOR

ADMISIÓN / ESCAPE
REFRIGERACIÓN

ELÉCTRICO

SUSPENSIÓN / DIRECCIÓN

FRENOS

TRANSMISIÓN

CONTROLES Y MANDOS

CHASIS

ACCESORIOS



Palier completo

Sustituye el palier original a un precio inigualable.



Palier completo super reforzado

Sustituye el palier original por un palier super reforzado, a un precio inigualable
(Todas las referencias que terminan en HD son de palieres super reforzados)

		PALIER DELANTERO IZQUIERDO		PALIER DELANTERO DERECHO		PALIER TRASERO IZQUIERDO		PALIER TRASERO DERECHO	
ARTIC CAT	Año	Referencia	P.V.P.	Referencia	P.V.P.	Referencia	P.V.P.	Referencia	P.V.P.
550 Prowler	09-14	PD2016HD	327,60	PD2017HD	327,60				
650 Prowler	06-09	PD2016HD	327,60	PD2017HD	327,60				
700 Prowler	08-10	PD2016HD	327,60	PD2017HD	327,60	PD2016HD	327,60	PD2016HD	327,60
700 Prowler	11-14	PD2017HD	327,60	PD2016HD	327,60				
1000 Prowler	09-14	PD2017HD	327,60	PD2016HD	327,60				
1000 ATV	11-14	PD1153HD	348,60	PD1154HD	348,60	PD1152HD	348,60	PD1152HD	348,60
1000 Wildcat	12-14	PD1163HD	348,60	PD1163HD	348,60	PD1162HD	348,60	PD1162HD	348,60
1000 Wildcat Trail	14-15	PD2018HD	374,43	PD2018HD	374,43	PD2019HD	374,43	PD2019HD	374,43
1000 Wildcat X	13-14	PD1163HD	348,60	PD1163HD	348,60	PD1162HD	348,60	PD1162HD	348,60
1000 Wildcat 4	13-14	PD1163HD	348,60	PD1163HD	348,60	PD1162HD	348,60	PD1162HD	348,60
		PALIER DELANTERO IZQUIERDO		PALIER DELANTERO DERECHO		PALIER TRASERO IZQUIERDO		PALIER TRASERO DERECHO	
CAN AM	Año	Referencia	P.V.P.	Referencia	P.V.P.	Referencia	P.V.P.	Referencia	P.V.P.
400 Outlander	06-08	PD1128HD	369,60	PD1127HD	369,60				
400 Outlander	09-12	PD1128HD	369,60	PD1127HD	369,60	PD1130HD	369,60	PD1129HD	369,60
400 Outlander	13-15	PD1128HD	369,60	PD1127HD	369,60	PD3021HD		PD3022HD	
400 Outlander MAX	06-08	PD1128HD	369,60	PD1127HD	369,60				
400 Outlander MAX	09-15	PD1128HD	369,60	PD1127HD	369,60	PD1130HD	369,60	PD1129HD	369,60
500 Outlander	07-12	PD1128HD	369,60	PD1127HD	369,60	PD1130HD	369,60	PD1129HD	369,60
500 Outlander	13-15	PD3016HD	420,25	PD3017HD	420,25	PD1130HD	369,60	PD1129HD	369,60
500 Outlander MAX	07-12	PD1128HD	369,60	PD1127HD	369,60	PD1130HD	369,60	PD1129HD	369,60
500 Outlander MAX	13-15	PD3016HD	420,25	PD3017HD	420,25	PD1130HD	369,60	PD1129HD	369,60
500 Renegade	08-12	PD1128HD	369,60	PD1127HD	369,60	PD1130HD	369,60	PD1129HD	369,60
500 Renegade	13-15	PD3016HD	420,25	PD3017HD	420,25	PD1130HD	369,60	PD1129HD	369,60
570 Outlander	2016	PD3016HD	420,25	PD3017HD	420,25	PD1130HD	369,60	PD1129HD	369,60
650 Outlander	07-12	PD1128HD	369,60	PD1127HD	369,60	PD1130HD	369,60	PD1129HD	369,60
650 Outlander	13-16	PD3016HD	420,25	PD3017HD	420,25	PD1130HD	369,60	PD1129HD	369,60
650 Outlander MAX	07-12	PD1128HD	369,60	PD1127HD	369,60	PD1130HD	369,60	PD1129HD	369,60
650 Outlander MAX	13-16	PD3016HD	420,25	PD3017HD	420,25	PD1130HD	369,60	PD1129HD	369,60
650 Outlander XMR	13-15	PD3016HD	420,25	PD3017HD	420,25	PD1130HD	369,60	PD1129HD	369,60
800 Commander	11-14	PD3001HD	369,60	PD3002HD	369,60	PD1156HD	369,60	PD1156HD	369,60
800 Outlander	07-12	PD1128HD	369,60	PD1127HD	369,60	PD1130HD	369,60	PD1129HD	369,60
800 Outlander	13-15	PD3016HD	420,25	PD3017HD	420,25	PD1130HD	369,60	PD1129HD	369,60
800 Outlander MAX	07-12	PD1128HD	369,60	PD1127HD	369,60	PD1130HD	369,60	PD1129HD	369,60
800 Outlander MAX	13-15	PD3016HD	420,25	PD3017HD	420,25	PD1130HD	369,60	PD1129HD	369,60
800 Renegade	07-12	PD1128HD	369,60	PD1127HD	369,60	PD1130HD	369,60	PD1129HD	369,60
800 Renegade	13-15	PD3016HD	420,25	PD3017HD	420,25	PD1130HD	369,60	PD1129HD	369,60
850 Outlander	2016	PD3016HD	420,25	PD3017HD	420,25	PD1130HD	369,60	PD1129HD	369,60
850 Outlander Max	2016	PD3016HD	420,25	PD3017HD	420,25	PD1130HD	369,60	PD1129HD	369,60
850 Renegade	2016	PD3016HD	420,25	PD3017HD	420,25	PD1130HD	369,60	PD1129HD	369,60
1000 Commander	11-14	PD3001HD	369,60	PD3002HD	369,60	PD1156HD	369,60	PD1156HD	369,60
1000 Maverick STD	13-16	PD3011HD	369,60	PD3012HD	369,60	PD3015HD	411,06	PD3015HD	411,06
1000 Maverick DPS	13-16	PD3011HD	369,60	PD3012HD	369,60	PD3015HD	411,06	PD3015HD	411,06
1000 Maverick XMR	13-16	PD3011HD	369,60	PD3012HD	369,60	PD3015HD	411,06	PD3015HD	411,06
1000 Maverick X	15-16					PD3023HD		PD3023HD	
1000 Maverick Turbo	15-16					PD3023HD		PD3023HD	
1000 Maverick XC-XXC	14-16	PD3018HD	420,25	PD3019HD	374,43	PD3020HD	443,35	PD3020HD	443,35
1000 Outlander	2012	PD1128HD	369,60	PD1127HD	369,60	PD1130HD	369,60	PD1129HD	369,60
1000 Outlander	13-16	PD3016HD	420,25	PD3017HD	420,25	PD1130HD	369,60	PD1129HD	369,60
1000 Outlander MAX	13-16	PD3016HD	420,25	PD3017HD	420,25	PD1130HD	369,60	PD1129HD	369,60
1000 Outlander XMR	13-14	PD3014	327,60	PD3013	327,60	PD1130HD	369,60	PD1129HD	369,60
1000 Renegade	2012	PD1128HD	369,60	PD1127HD	369,60	PD1130HD	369,60	PD1129HD	369,60
1000 Renegade	13-16	PD3016HD	420,25	PD3017HD	420,25	PD1130HD	369,60	PD1129HD	369,60

	PALIER DELANTERO IZQUIERDO		PALIER DELANTERO DERECHO		PALIER TRASERO IZQUIERDO		PALIER TRASERO DERECHO		
HONDA	Año	Referencia	P.V.P.	Referencia	P.V.P.	Referencia	P.V.P.	Referencia	P.V.P.
TRX 350 Rancher	00-05	PD1085	237,30	PD1085	237,30				
TRX 400 Rancher	95-01	PD1122	237,30	PD1072	237,30				
TRX 400 Rancher	04-07	PD1082	237,30	PD1082	237,30				
TRX 420 Rancher	07-08	PD4007HD	327,60	PD4007HD	327,60				
TRX 420 Rancher	09-14	PD4007HD	327,60	PD4007HD	327,60	PD4010HD	327,60	PD4011HD	327,60
TRX 450 Foreman	98-04	PD1068	237,30	PD1076	237,30				
TRX 500 Foreman	01-04	PD1066	237,30	PD1074	237,30				
TRX 500 Foreman	05-07	PD1071	237,30	PD1079	237,30				
TRX 500 Foreman	08-09	PD4001	237,30	PD4002	237,30				
TRX 500 Foreman	11-12	PD1071	237,30	PD1079	237,30				
TRX 650 Rincon	03-05	PD4024HD	327,60	PD4025HD	327,60	PD1080HD	374,43	PD1080HD	374,43
TRX 680 Rincon	06-15	PD4024HD	327,60	PD4025HD	327,60	PD1080HD	374,43	PD1080HD	374,43
		PALIER DELANTERO IZQUIERDO		PALIER DELANTERO DERECHO		PALIER TRASERO IZQUIERDO		PALIER TRASERO DERECHO	
KAWASAKI	Año	Referencia	P.V.P.	Referencia	P.V.P.	Referencia	P.V.P.	Referencia	P.V.P.
KVF 360 Prairie	03-12	PD1105	237,30	PD1013	237,30				
KVF 400 Prairie	97-02	PD1109	237,30	PD1009	237,30				
KVF 650 Brute Force	05-13	PD1105	237,30	PD1013	237,30				
KVF 650i Brute Force	06-13	PD1106HD	348,60	PD1107HD	348,60	PD1112HD	327,60	PD1112HD	327,60
KVF 650 Prairie	02-03	PD1105	237,30	PD1013	237,30				
KVF 700 Prairie	04-06	PD1105	237,30	PD1013	237,30				
KVF 750i Brute Force	05-14	PD1106HD	348,60	PD1107HD	348,60	PD1112HD	327,60	PD1112HD	327,60
KRF 750 Teryx	08-13	PD1131HD	327,60	PD1131HD	327,60	PD1113HD	298,20	PD1114HD	298,20
		PALIER DELANTERO IZQUIERDO		PALIER DELANTERO DERECHO		PALIER TRASERO IZQUIERDO		PALIER TRASERO DERECHO	
POLARIS	Año	Referencia	P.V.P.	Referencia	P.V.P.	Referencia	P.V.P.	Referencia	P.V.P.
Ranger 400	10-14	PD1135HD	327,60	PD1135HD	327,60	PD1136HD	327,60	PD1136HD	327,60
Ranger 500	2009	PD6058HD	348,60	PD6058HD	348,60				
Ranger 500	2010	PD6058HD	348,60	PD6058HD	348,60	PD1134HD	327,60	PD1134HD	327,60
Ranger 500	11-13	PD1135HD	327,60	PD1135HD	327,60	PD1136HD	327,60	PD1136HD	327,60
Ranger 570	2015	PD6058HD	348,60	PD6058HD	348,60	PD6070HD		PD6070HD	
Ranger 570	2016	PD6064HD	374,43	PD6064HD	374,43	PD6070HD		PD6070HD	
Ranger 700	2009	PD6058HD	348,60	PD6058HD	348,60				
Ranger 800	10-14	PD6058HD	348,60	PD6058HD	348,60	PD1134HD	327,60	PD1134HD	327,60
Ranger 800	15-16	PD6058HD	348,60	PD6058HD	348,60				
Ranger 900 XP	13-15	PD6058HD	348,60	PD6058HD	348,60	PD1134HD	327,60	PD1134HD	327,60
Ranger 1000	2015	PD6058HD	348,60	PD6058HD	348,60				
Ranger EV	10-15					PD1136HD	327,60	PD1136HD	327,60
Ranger LSV	11-12					PD1136HD	327,60	PD1136HD	327,60
RZR 570	12-15	PD6029HD	327,60	PD6029HD	327,60	PD6069HD		PD6069HD	
RZR 800	08-14	PD6029HD	327,60	PD6029HD	327,60	PD1138HD	327,60	PD1138HD	327,60
RZR 800 S	09-14	PD6067HD		PD6067HD		PD6005HD	374,43	PD6005HD	374,43
RZR 800 4	10-14	PD6067HD		PD6067HD		PD6005HD	374,43	PD6005HD	374,43
RZR 900 XP	11-14	PD6016HD	327,60	PD6016HD	327,60	PD1158HD	327,60	PD1158HD	327,60
RZR 900 XP	15-16	PD6061HD	327,60	PD6061HD	327,60	PD6062HD	374,43	PD6062HD	374,43
RZR 1000 XP	14-16	PD6057HD	348,60	PD6057HD	348,60	PD6052HD	369,60	PD6052HD	369,60
RZR 1000 XP Turbo	2016					PD6052HD	369,60	PD6052HD	369,60
RZR 1000 XP "4"	14-16	PD6057HD	348,60	PD6057HD	348,60	PD6052HD	369,60	PD6052HD	369,60
Scrambler 400	95-02	PD1006U	273,00	PD1006U	273,00				
Scrambler 500	97-09	PD1006U	273,00	PD1006U	273,00				
Scrambler 850	13-15	PD6029HD	327,60	PD6029HD	327,60	PD1132HD	327,60	PD1132HD	327,60
Scrambler 1000	14-15	PD6029HD	327,60	PD6029HD	327,60	PD1132HD	327,60	PD1132HD	327,60
Sportsman 325 ACE	15-16	PD6068HD		PD6068HD		PD6069HD		PD6069HD	
Sportsman 335	2000	PD1006U	273,00	PD1006U	273,00	PD6008HD	374,43	PD6008HD	374,43
Sportsman 400	01-02	PD1006U	273,00	PD1006U	273,00	PD6008HD	374,43	PD6008HD	374,43
Sportsman 400	03-04	PD1006U	273,00	PD1006U	273,00	PD1018HD	327,60	PD1018HD	327,60
Sportsman 400	2005					PD1018HD	327,60	PD1018HD	327,60
Sportsman 400	11-13					PD1018HD	327,60	PD1018HD	327,60
Sportsman 400	2014					PD1018HD	327,60	PD1018HD	327,60
Sportsman 450	2007	PD1157HD	327,60	PD1157HD	327,60	PD1018HD	327,60	PD1018HD	327,60
Sportsman 450	2006	PD1117	237,30	PD1117	237,30	PD1018HD	327,60	PD1018HD	327,60
Sportsman 500	99-02	PD1006U	273,00	PD1006U	273,00	PD6008HD	374,43	PD6008HD	374,43
Sportsman 500	03-04	PD1006U	273,00	PD1006U	273,00	PD1018HD	327,60	PD1018HD	327,60
Sportsman 500	2005	PD1157HD	327,60	PD1157HD	327,60	PD1018HD	327,60	PD1018HD	327,60
Sportsman 500	06-07					PD1018HD	327,60	PD1018HD	327,60
Sportsman 500	08-11	PD1157HD	327,60	PD1157HD	327,60				
Sportsman 500	2012	PD1157HD	327,60	PD1157HD	327,60	PD1018HD	327,60	PD1018HD	327,60
Sportsman 500	13-14					PD1018HD	327,60	PD1018HD	327,60

RUEDAS Y NEUMÁTICOS

MOTOR

ADMISIÓN / ESCAPE
REFRIGERACIÓN

ELÉCTRICO

SUSPENSIÓN / DIRECCIÓN

FRENOS

TRANSMISIÓN

CONTROLES Y MANDOS

CHASIS

ACCESORIOS

TRANSMISIÓN

		PALIER DELANTERO IZQUIERDO		PALIER DELANTERO DERECHO		PALIER TRASERO IZQUIERDO		PALIER TRASERO DERECHO	
Sportsman 500 Touring	08-13	PD1157HD	327,60	PD1157HD	327,60				
Sportsman 500 X2	2007	PD1157HD	327,60	PD1157HD	327,60	PD1018HD	327,60	PD1018HD	327,60
Sportsman 500 X2	06-09	PD1157HD	327,60	PD1157HD	327,60				
Sportsman 550	09-14	PD6029HD	327,60	PD6029HD	327,60	PD1132HD	327,60	PD1132HD	327,60
Sportsman 550 Touring	10-14	PD6029HD	327,60	PD6029HD	327,60	PD1132HD	327,60	PD1132HD	327,60
Sportsman 550 X2	10-14	PD6029HD	327,60	PD6029HD	327,60	PD1132HD	327,60	PD1132HD	327,60
Sportsman 570	2014					PD1018HD	327,60	PD1132HD	327,60
Sportsman 570 Touring	2014					PD1018HD	327,60	PD1132HD	327,60
Sportsman 570 ACE	15-16	PD6068HD		PD6068HD		PD6069HD		PD6069HD	
Sportsman 600	2003	PD1007U	273,00	PD1007U	273,00	PD1018HD	327,60	PD1018HD	327,60
Sportsman 600	2004					PD1018HD	327,60	PD1018HD	327,60
Sportsman 600	2005	PD1157HD	327,60	PD1157HD	327,60	PD1018HD	327,60	PD1018HD	327,60
Sportsman 700	03-04					PD1018HD	327,60	PD1018HD	327,60
Sportsman 700	2005	PD1157HD	327,60	PD1157HD	327,60	PD1018HD	327,60	PD1018HD	327,60
Sportsman 700	2006					PD1018HD	327,60	PD1018HD	327,60
Sportsman 700	2007	PD1157HD	327,60	PD1157HD	327,60	PD1018HD	327,60	PD1018HD	327,60
Sportsman 700	2008	PD1157HD	327,60	PD1157HD	327,60				
Sportsman 800	05-12	PD1157HD	327,60	PD1157HD	327,60	PD1018HD	327,60	PD1018HD	327,60
Sportsman 800	13-14					PD1018HD	327,60	PD1018HD	327,60
Sportsman 800 Touring	08-09	PD1157HD	327,60	PD1157HD	327,60				
Sportsman 800 X2	2007	PD1157HD	327,60	PD1157HD	327,60	PD1018HD	327,60	PD1018HD	327,60
Sportsman 800 X2	08-09	PD1157HD	327,60	PD1157HD	327,60				
Sportsman 850	09-15	PD6029HD	327,60	PD6029HD	327,60	PD1132HD	327,60	PD1132HD	327,60
Sportsman 850 Touring	10-15	PD6029HD	327,60	PD6029HD	327,60	PD1132HD	327,60	PD1132HD	327,60
Sportsman 850 ACE	2016	PD6068HD		PD6068HD		PD6069HD		PD6069HD	
Sportsman 1000	2015	PD6029HD	327,60	PD6029HD	327,60	PD1132HD	327,60	PD1132HD	327,60
Sportsman 1000 Touring	2015	PD6029HD	327,60	PD6029HD	327,60	PD1132HD	327,60	PD1132HD	327,60

		PALIER DELANTERO IZQUIERDO		PALIER DELANTERO DERECHO		PALIER TRASERO IZQUIERDO		PALIER TRASERO DERECHO	
SUZUKI	Año	Referencia	P.V.P.	Referencia	P.V.P.	Referencia	P.V.P.	Referencia	P.V.P.
LT-A 400 King Quad	08-14	PD7006	285,60	PD7005	285,60				
LT-A 450 King Quad	07-10	PD1125HD	369,60	PD1125HD	369,60	PD1124HD	327,60	PD1124HD	327,60
LT-A 500 King Quad	11-15	PD1125HD	369,60	PD1125HD	369,60	PD1124HD	327,60	PD1124HD	327,60
LT-A 500 Vinson	04-07	PD7001	237,30	PD7002	237,30				
LT-A 700 King Quad	2005					PD1124HD	327,60	PD1124HD	327,60
LT-A 700 King Quad	06-07	PD1125HD	369,60	PD1125HD	369,60	PD1124HD	327,60	PD1124HD	327,60
LT-A 750 King Quad	08-15	PD1125HD	369,60	PD1125HD	369,60	PD1124HD	327,60	PD1124HD	327,60

		PALIER DELANTERO IZQUIERDO		PALIER DELANTERO DERECHO		PALIER TRASERO IZQUIERDO		PALIER TRASERO DERECHO	
YAMAHA	Año	Referencia	P.V.P.	Referencia	P.V.P.	Referencia	P.V.P.	Referencia	P.V.P.
YFM 350 Big Bear	97-99	PD1097	237,30	PD1097	237,30				
YFM 350 Grizzly	07-11	PD8007	237,30	PD8008	237,30				
YFM 400 Big Bear	00-01	PD1097	237,30	PD1097	237,30				
YFM 400 Big Bear	02-06	PD1100	237,30	PD1100	237,30				
YFM 400 Big Bear	07-11	PD8007	237,30	PD8008	237,30	PD8012	237,30	PD8013	237,30
YFM 400 Grizzly	2007	PD1098	237,30	PD1098	237,30	PD1101	237,30	PD1101	237,30
YFM 400 Grizzly	2008	PD1098	237,30	PD1098	237,30				
YFM 400 Kodiak	1999	PD1097	237,30	PD1097	237,30				
YFM 400 Kodiak	00-04	PD1098	237,30	PD1098	237,30				
YFM 400 Kodiak	05-06	PD1098	237,30	PD1098	237,30	PD1101	237,30	PD1101	237,30
YFM 450 Grizzly	08-11	PD8007	237,30	PD8008	237,30				
YFM 450 Grizzly	2007	PD1087	237,30	PD1090	237,30	PD1101	237,30	PD1101	237,30
YFM 450 Kodiak	03-04	PD1087	237,30	PD1090	237,30				
YFM 450 Kodiak	05-06	PD1087	237,30	PD1090	237,30	PD1101	237,30	PD1101	237,30
YFM 550 Grizzly	09-13	PD1139HD	327,60	PD1139HD	327,60	PD1104HD	327,60	PD1104HD	327,60
YFM 660 Grizzly	03-08	PD1088HD	327,60	PD1091HD	327,60	PD1092HD	327,60	PD1093HD	327,60
YFM 700 Grizzly	07-13	PD1139HD	327,60	PD1139HD	327,60	PD1104HD	327,60	PD1104HD	327,60
YFM 700 Grizzly	14-15	PD8016HD	420,25	PD8016HD	420,25				
YXR 450 Rhino	06-09	PD8001HD	327,60	PD8002HD	327,60	PD1102HD	327,60	PD1103HD	327,60
YXR 660 Rhino	04-05					PD1102HD	327,60	PD1103HD	327,60
YXR 660 Rhino	06-07	PD8001HD	327,60	PD8002HD	327,60	PD1102HD	327,60	PD1103HD	327,60
YXR 700 Rhino	08-13	PD8001HD	327,60	PD8001HD	327,60	PD1102HD	327,60	PD1103HD	327,60
YXM 700 Viking	14-16	PD8014HD	374,43	PD8014HD	374,43	PD8015HD	374,43	PD8015HD	374,43



P.V.P
127,46

P.V.P
140,90



Punteras completas



		PALIER DELANTERO IZQUIERDO		PALIER DELANTERO DERECHO		PALIER TRASERO IZQUIERDO		PALIER TRASERO DERECHO	
CAN AM									
Año	Exterior	Interior	Exterior	Interior	Exterior	Interior	Exterior	Interior	
400 Outlander	03-05	PDV1071		PDV1071		PDV1075		PDV1075	
400 Outlander	06-08	PDV1074		PDV1074		PDV1075		PDV1075	
400 Outlander	09-12	PDV1074		PDV1074					
400 Outlander MAX	06-08	PDV1074		PDV1074		PDV1075		PDV1075	
400 Outlander MAX	09-12	PDV1074		PDV1074					
500 Outlander	2007	PDV1074		PDV1074		PDV1076		PDV1076	
500 Outlander	08-12	PDV1074		PDV1074					
500 Outlander MAX	2007	PDV1074		PDV1074		PDV1076		PDV1076	
500 Outlander MAX	08-12	PDV1074		PDV1074					
500 Renegade	08-12	PDV1074		PDV1074					
650 Outlander	06-07	PDV1074		PDV1074		PDV1076		PDV1076	
650 Outlander	08-12	PDV1074		PDV1074					
650 Outlander MAX	06-07	PDV1074		PDV1074		PDV1076		PDV1076	
650 Outlander MAX	08-12	PDV1074		PDV1074					
800 Outlander	2006	PDV1074		PDV1074		PDV1076		PDV1076	
800 Outlander	07-12	PDV1074		PDV1074					
800 Outlander MAX	06-07	PDV1074		PDV1074		PDV1076		PDV1076	
800 Outlander MAX	08-12	PDV1074		PDV1074					
800 Renegade	2007	PDV1074		PDV1074		PDV1076		PDV1076	
800 Renegade	08-12	PDV1074		PDV1074					
1000 Renegade	2012	PDV1074		PDV1074					
HONDA									
Año	Exterior	Interior	Exterior	Interior	Exterior	Interior	Exterior	Interior	
TRX 350 Rancher	00-05	PDV1030	PDV1143	PDV1030	PDV1143				
TRX 350 Rancher	2006	PDV1030		PDV1030					
TRX 400 Rancher	95-03	PDV1001		PDV1001					
TRX 400 Rancher	04-07	PDV1030		PDV1030					
TRX 420 Rancher	07-09	PDV1126		PDV1126					
TRX 450 Foreman	98-04	PDV1001	PDV1134	PDV1001	PDV1134				
TRX 500 Foreman	01-04	PDV1015	PDV1134	PDV1015	PDV1134				
TRX 500 Foreman	05-07	PDV1015	PDV1143	PDV1015	PDV1143				
TRX 500 Foreman	08-13	PDV1126	PDV1143	PDV1126	PDV1143				
TRX 650 Rincon	03-04	PDV1015		PDV1015		PDV1062		PDV1062	
TRX 650 Rincon	2005	PDV1015	PDV1143	PDV1015	PDV1143	PDV1062		PDV1062	
TRX 680 Rincon	06-07	PDV1015	PDV1143	PDV1015	PDV1143	PDV1062		PDV1062	
TRX 680 Rincon	08-13	PDV1126	PDV1143	PDV1126	PDV1143	PDV1062		PDV1062	
KAWASAKI									
Año	Exterior	Interior	Exterior	Interior	Exterior	Interior	Exterior	Interior	
KVF 400 Prairie	97-02	PDV1010	PDV1087	PDV1010	PDV1087				
KVF 650 Brute Force	05-09	PDV1109	PDV1103	PDV1109	PDV1102				
KVF 650 Brute Force	10-13		PDV1103		PDV1102				
KVF 650i Brute Force	06-08	PDV1163	PDV1103	PDV1163	PDV1102	PDV1069	PDV1105	PDV1069	
KVF 650i Brute Force	09-13	PDV1163	PDV1103	PDV1163	PDV1102		PDV1123	PDV1123	
KVF 650 Prairie	02-03	PDV1023	PDV1101	PDV1023	PDV1100				
KVF 700 Prairie	04-06	PDV1109	PDV1103	PDV1109	PDV1102				
KVF 750i Brute Force	05-07	PDV1163	PDV1103	PDV1163	PDV1102	PDV1069	PDV1105	PDV1069	
KVF 750i Brute Force	08-11	PDV1164		PDV1164			PDV1123	PDV1123	
KVF 750i Brute Force	12-13	PDV1163	PDV1103	PDV1163	PDV1102		PDV1123	PDV1123	
KRF 750 Teryx	2008					PDV1125	PDV1122	PDV1125	
KRF 750 Teryx	09-12	PDV1124	PDV1123	PDV1124	PDV1123	PDV1125	PDV1122	PDV1125	
POLARIS									
Año	Exterior	Interior	Exterior	Interior	Exterior	Interior	Exterior	Interior	
Scrambler 400	99-02	PDV1004		PDV1004					
Scrambler 500	99-09	PDV1004		PDV1004					
Sportsman 500	08-10	PDV1129		PDV1129		PDV1140		PDV1140	
Sportsman 500	11-14					PDV1174		PDV1174	
RZR 570	12-15	PDV1118	PDV1115	PDV1118	PDV1115				
Ranger 700	2005	PDV1155		PDV1155		PDV1027	PDV1160	PDV1027	

RUEDAS Y NEUMÁTICOS

MOTOR

ADMISIÓN / ESCAPE
REFRIGERACIÓN

ELÉCTRICO

SUSPENSIÓN / DIRECCIÓN

FRENOS

TRANSMISIÓN

CONTROLES Y MANDOS

CHASIS

ACCESORIOS



Punteras completas

P.V.P
127,46

P.V.P
140,90

Ranger 700	06-07	PDV1064	PDV1091	PDV1064	PDV1091	PDV1027	PDV1160	PDV1027	PDV1159
Ranger 700	08-09	PDV1138		PDV1138		PDV1140		PDV1140	
Sportsman 700	03-04	PDV1017		PDV1017		PDV1027	PDV1090	PDV1027	PDV1090
Sportsman 700	2005	PDV1136	PDV1091	PDV1136	PDV1091	PDV1027	PDV1090	PDV1027	PDV1090
Sportsman 700	2006	PDV1156		PDV1156		PDV1130	PDV1090	PDV1130	PDV1090
Sportsman 700	2008	PDV1129		PDV1129					
Ranger 800	2010	PDV1139		PDV1139		PDV1142		PDV1142	
RZR 800	08-10	PDV1118	PDV1115	PDV1118	PDV1115	PDV1119	PDV1116	PDV1119	PDV1116
RZR 800	11-14	PDV1118	PDV1115	PDV1118	PDV1115				
Sportsman 800	08-10	PDV1129		PDV1129		PDV1140		PDV1140	
Ranger 900	11-12					PDV1174		PDV1174	
Ranger 900	13-15	PDV1118	PDV1115	PDV1118	PDV1115	PDV1174		PDV1174	
RZR 900 XP	11-14	PDV1173		PDV1173		PDV1174		PDV1174	
Ranger 1000	2015	PDV1118	PDV1115	PDV1118	PDV1115	PDV1174		PDV1174	
RZR 1000 XP	14-15	PDV1173		PDV1173					

PALIER DELANTERO IZQUIERDO

PALIER DELANTERO DERECHO

PALIER TRASERO IZQUIERDO

PALIER TRASERO DERECHO

SUZUKI									
Año	Exterior	Interior	Exterior	Interior	Exterior	Interior	Exterior	Interior	Interior
LT-A 400 Eiger	2002	PDV1128		PDV1128					
LT-A 400 Eiger "68LAC"	03-04	PDV1128		PDV1128					
LT-A 400 Eiger "UJ68"	03-04	PDV1145		PDV1145					
LT-A 400 Eiger	05-07	PDV1128		PDV1128					
LT-A 450 King Quad	07-10	PDV1172	PDV1176	PDV1172	PDV1176	PDV1171	PDV1175	PDV1171	PDV1175
LT-A 500 King Quad	09-12	PDV1172		PDV1172		PDV1171	PDV1175	PDV1171	PDV1175
LT-A 500 King Quad PS	11-12	PDV1172	PDV1176	PDV1172	PDV1176	PDV1171	PDV1175	PDV1171	PDV1175
LT-A 500 Vinson	2002	PDV1128		PDV1128					
LT-A 500 Vinson	03-05	PDV1145		PDV1145					
LT-A 500 Vinson	06-07	PDV1128		PDV1128					
LT-A 700 King Quad	2005	PDV1144		PDV1144		PDV1131		PDV1131	
LT-A 700 King Quad	2006	PDV1144		PDV1144					
LT-A 700 King Quad "18 dientes"	2007					PDV1131		PDV1131	
LT-A 700 King Quad "26 dientes"	2007					PDV1171	PDV1175	PDV1171	PDV1175
LT-A 750 King Quad	08-14	PDV1172	PDV1176	PDV1172	PDV1176	PDV1171	PDV1175	PDV1171	PDV1175

PALIER DELANTERO IZQUIERDO

PALIER DELANTERO DERECHO

PALIER TRASERO IZQUIERDO

PALIER TRASERO DERECHO

YAMAHA									
Año	Exterior	Interior	Exterior	Interior	Exterior	Interior	Exterior	Interior	Interior
YFM 350 Big Bear	97-99	PDV1002	PDV1087	PDV1002	PDV1087				
YFM 350 Grizzly	07-11	PDV1026	PDV1127	PDV1026	PDV1127				
YFM 350 Grizzly	12-14	PDV1162	PDV1078	PDV1162	PDV1078				
YFM 400 Big Bear	00-01	PDV1002	PDV1087	PDV1002	PDV1087				
YFM 400 Big Bear	02-06		PDV1127	PDV1002	PDV1127				
YFM 400 Big Bear	07-12	PDV1162	PDV1078	PDV1162	PDV1078	PDV1058	PDV1085	PDV1058	PDV1085
YFM 400 Grizzly	2007	PDV1026	PDV1127	PDV1026	PDV1127	PDV1058	PDV1085	PDV1058	PDV1085
YFM 400 Kodiak	00-04	PDV1026	PDV1127	PDV1026	PDV1127				
YFM 400 Kodiak	05-06	PDV1026	PDV1127	PDV1026	PDV1127	PDV1058	PDV1085	PDV1058	PDV1085
YFM 450 Grizzly	2007	PDV1026	PDV1157	PDV1026		PDV1058	PDV1085	PDV1058	PDV1085
YFM 450 Grizzly	08-10	PDV1162	PDV1078	PDV1162	PDV1078	PDV1058	PDV1085	PDV1058	PDV1085
YFM 450 Grizzly	11-14	PDV1162	PDV1078	PDV1162	PDV1078		PDV1084		PDV1084
YFM 450 Kodiak	03-04	PDV1026	PDV1157	PDV1026					
YFM 450 Kodiak	05-06	PDV1026	PDV1157	PDV1026		PDV1058	PDV1085	PDV1058	PDV1085
YFM 450 Wolverine	06-10	PDV1026	PDV1127	PDV1026	PDV1127				
YFM 550 Grizzly	09-14	PDV1061	PDV1083	PDV1061	PDV1083	PDV1061	PDV1084	PDV1061	PDV1084
YFM 660 Grizzly	2002	PDV1026	PDV1157	PDV1026		PDV1056	PDV1079	PDV1056	PDV1080
YFM 660 Grizzly "UJ68"	2003	PDV1005	PDV1077	PDV1005	PDV1078	PDV1005	PDV1081	PDV1005	PDV1082
YFM 660 Grizzly "68LAC"	2003	PDV1014	PDV1077	PDV1014	PDV1078	PDV1005	PDV1081	PDV1005	PDV1082
YFM 660 Grizzly	04-08	PDV1014	PDV1077	PDV1014	PDV1078	PDV1014	PDV1081	PDV1014	PDV1082
YFM 700 Grizzly	07-14	PDV1061	PDV1083	PDV1061	PDV1083	PDV1061	PDV1084	PDV1061	PDV1084
YXR 660 Rhino	2004	PDV1057	PDV1078	PDV1057	PDV1077	PDV1057	PDV1082	PDV1057	PDV1081
YXR 660 Rhino	2005	PDV1060	PDV1078	PDV1060	PDV1077	PDV1060	PDV1080	PDV1060	PDV1079
YXR 660 Rhino	06-07	PDV1059	PDV1078	PCV1059	PDV1077	PDV1059	PDV1080	PCV1059	PDV1079
YXR 700 Rhino	08-13	PDV1059	PDV1083	PCV1059	PDV1083	PDV1059		PCV1059	

BRONCO Fuelles palier

Los fuelles constan de dos bridas de sujeción, grasa y el fuelle de goma.



P.V.P
19,86

ARTIC CAT	Año	FUELLE PALIER DELANTERO		FUELLE PALIER TRASERO	
		Interior	Exterior	Interior	Exterior
todos anterior al 2010	03-10	DAT08542	DAT08542	DAT08542	DAT08542
todos anterior al 2010	11-14	DAT08542	DAT08542	DAT08542	DAT08542
300 todos	98-05	DAT08542	DAT08542	DAT08542	DAT08542
400 todos	03-10	DAT08542	DAT08542	DAT08542	DAT08542
400 todos	11-14	DAT03086	DAT03086	DAT03086	DAT03086
450 todos	11-12	DAT03086	DAT03086	DAT03086	DAT03086
500 todos	13-14	DAT03086	DAT03086	DAT03086	DAT03086
550 todos	09-10	DAT08542	DAT08542	DAT08542	DAT08542
550 todos	11-14	DAT03086	DAT03086	DAT03086	DAT03086
650	04-10	DAT08542	DAT08542	DAT08542	DAT08542
650 Mudpro	2011	DAT03085	DAT03085	DAT03085	DAT03085
650 todos excepto Mudpro	11-12	DAT03086	DAT03086	DAT03086	DAT03086
700 todos	07-10	DAT08542	DAT08542	DAT08542	DAT08542
700 Mudpro	11-13	DAT03085	DAT03085	DAT03085	DAT03085
700 todos excepto Mudpro	11-14	DAT03086	DAT03086	DAT03086	DAT03086
1000 Wildcat	12-14	DAT03085	DAT03085	DAT03085	DAT03085
1000 Wildcat 4	13-14	DAT03085	DAT03085	DAT03085	DAT03085

CAN AM	Año	FUELLE PALIER DELANTERO		FUELLE PALIER TRASERO	
		Interior	Exterior	Interior	Exterior
330 Outlander	04-05	DAT08541	DAT085251	DAT08547	DAT08586
400 Outlander	03-05	DAT08541	DAT085251	DAT08547	DAT08586
400 Outlander	06-08	DAT08546	DAT08545	DAT08547	DAT08586
400 Outlander	09-12	DAT08546	DAT08545		
500 Outlander	2007	DAT08546	DAT08545	DAT08583	DAT08583
500 Outlander	08-12	DAT08546	DAT08545	DAT03079	DAT03079
500 Quest 4x4	02-04	DAT08541	DAT085251		
500 Renegade	2008	DAT08546	DAT08545	DAT03079	DAT03079
500 Traxter	99-05	DAT08541	DAT085251		
650 Outlander	06-07	DAT08546	DAT08545	DAT08583	DAT08583
650 Outlander	08-12	DAT08546	DAT08545	DAT03079	DAT03079
650 Quest	02-04	DAT08541	DAT085251		
650 Traxter	2005	DAT08541	DAT085251		
800 Outlander	06-12	DAT08546	DAT08545	DAT08583	DAT08583
800 Renegade	2007	DAT08546	DAT08545	DAT08583	DAT08583
800 Renegade	08-12	DAT08546	DAT08545	DAT03079	DAT03079
800 Commander	11-12	DAT08546	DAT08545	DAT03079	DAT03079
1000 Rengade	2012	DAT08546	DAT08545	DAT03079	DAT03079
1000 Outlander	2012	DAT08546	DAT08545	DAT03079	DAT03079
1000 Commander	11-12	DAT08546	DAT08545	DAT03079	DAT03079

HONDA	Año	FUELLE PALIER DELANTERO		FUELLE PALIER TRASERO	
		Interior	Exterior	Interior	Exterior
TRX 350 Rancher	00-05	DAT08593	DAT08540		
TRX 350 Rancher	2006	DAT085251	DAT08540		
TRX 400	95-01	DAT08540	DAT08540		
TRX 400	2003	DAT08593	DAT08540		
TRX 420 Rancher	07-14	DAT085251	DAT08540		
TRX 450 Foreman	98-03	DAT08593	DAT08540		
TRX 500 Foreman	05-07	DAT085251	DAT08542		
TRX 500 Foreman	08-13	DAT085251	DAT08540		
TRX 500 Rubicon	01-04	DAT08593	DAT08542		
TRX 500 Rubicon	05-07	DAT085251	DAT08542		
TRX 500 Rubicon	08-14	DAT085251	DAT08540		
TRX 650 Rincon	03-04	DAT08593	DAT08542	DAT08547	DAT08547
TRX 650 Rincon	2005	DAT085251	DAT08542	DAT08547	DAT08547
TRX 680 Rincon	06-07	DAT085251	DAT08542	DAT08547	DAT08547
TRX 680 Rincon	08-14	DAT085251	DAT08540	DAT08547	DAT08547

Referencia	A (mm)	B (mm)	C (mm)
DAT03076	20,0	67,0	115,0
DAT03077	20,0	71,0	71,0
DAT03078	24,0	77,0	105,0
DAT03079	23,0	76,0	111,0
DAT03080			
DAT03081			
DAT03082			
DAT03083			
DAT03085	23,1	73,9	93,8
DAT03086**	18,4	65,7	93,8
DAT03087	18,2	60,8	85,5
DAT03088	19,9	62,6	97,0
DAT03089			
DAT03090	17,7	58,5	87,0
DAT03092			
DAT08504	18	59,5	88
DAT08505	19	64	86
DAT08506	18,2	67,5	105
DAT08511*	20	60/72/81	85/103/127
DAT08512	17,5	56,8	85,5
DAT08521*	16,3	59/73	80/106
DAT08522	19	69	105
DAT08523	18	62	82
DAT08524	23	72,5	130
DAT08525	17,8	56,5	79,9
DAT085251**	17,8	56,5	79,9
DAT08540	17,25	62,75	86,78
DAT085402**	17,5	63,0	79,0
DAT08541	25	78,04	95,4
DAT08542	18,43	65,69	93,82
DAT08543	20,39	76	98,3
DAT08544	22,35	75,59	98,5
DAT08545	18,7	65,3	98,5
DAT08546	19,9	62	95,6
DAT08547	18,9	64,1	92,3
DAT08583	18,9	77,9	105,3
DAT08585	19,2	66,9	104,9
DAT08586	18,5	70,5	110
DAT08587	20,4	72,06	106,45
DAT08593	18,6	59,65	102

* Modelo universal

** DAT085402 / DAT085251 Este fuelle se entrega con dos juegos de abrazaderas y dos paquetes de grasa



DUP12077

P.V.P
15,44€



DMC12758

P.V.P
22,37€

BRONCO Fuelles palier

KAWASAKI	Año	FUELLE PALIER DELANTERO		FUELLE PALIER TRASERO	
		Interior	Exterior	Interior	Exterior
KLF 300 Bayou	89-04	DAT08593	DAT08540		
KVF 300 Prairie	99-02	DAT08540	DAT08540		
KVF 360 Prairie	03-05	DAT08540	DAT08540		
KVF 360 Prairie	06-08	DAT085251	DAT08540		
KVF 360 Prairie	09-13	DAT085251			
KLF 400 Bayou	93-99	DAT08593	DAT08540		
KVF 400 Prairie	98-02	DAT08540	DAT08540		
KVF 650 Brute Force	04-09	DAT085251	DAT08540		
KVF 650 Brute Force	10-13	DAT085251			
KVF 650i Brute Force	06-08	DAT085251	DAT08542	DAT08547	DAT08542
KVF 650i Brute Force	09-13	DAT085251	DAT08545	DAT03076	DAT03076
KVF 650 Prairie	02-03	DAT08540	DAT08540		
KVF 700 Prairie	04-06	DAT085251	DAT08540		
KVF 750i Brute Force	05-07	DAT085251	DAT08542	DAT08547	DAT08542
KVF 750i Brute Force	08-11	DAT08546	DAT08545	DAT08542	DAT03076
KVF 750i Brute Force	12-15	DAT085251	DAT08545	DAT08542	DAT03076
KRT 750 Teryx	08-09			DAT03078	DAT03077
KRT 750 Teryx	10-11	DAT085251	DAT03076	DAT03078	DAT03077
KRT 750 Teryx	12-13	DAT085251	DAT03076		
750 Teryx	2009	DAT08525			
2510 Mule	00-02	DAT08593	DAT08540		
3010 Mule	01-08	DAT08593	DAT08540		
4010 Mule	09-15	DAT085251			

POLARIS	Año	FUELLE PALIER DELANTERO		FUELLE PALIER TRASERO	
		Interior	Exterior	Interior	Exterior
250 Xplorer	00-02	-	DAT08587	-	-
300 Hawkeye	06-07	DAT08540	DAT08540	DAT08540	DAT08540
300 Sportsman	08-10	DAT08540	DAT08540	DAT08540	DAT08540
300 Xplorer	96-99	-	DAT08586	-	-
300 Xplorer	00-02	-	DAT08587	-	-
325 Magnum	00-02	-	DAT08586	-	-
325 Ranger	2015	DAT08585	DAT08585		
325 Sportsman ACE	2015			DAT08583	DAT08583
325 Xpedition	00-02	-	DAT08586	-	-
330 Magnum HDS	03-04		DAT08586	-	-
330 Magnum excluido HDS	03-04		DAT08587	-	-
330 Magnum	05-06	DAT08585	DAT08587	-	-
400 Ranger	10-15	DAT08585	DAT08585	DAT08583	DAT08583
400 Scrambler	95-96	-	DAT08586	-	-
400 Scrambler	97-98	-	DAT08587	-	-
400 Scrambler	1999	-	DAT08586	-	-
400 Scrambler	00-02	-	DAT08587	-	-
400 Sportsman	2001	-	DAT08586	DAT08544	DAT08543
400 Sportsman	2002	-	DAT08587	DAT08544	DAT08543
400 Sportsman	03-04	-	DAT08587	DAT08544	DAT08541
400 Sportsman	2005	DAT08585	DAT08587	DAT08544	DAT08541
400 Sportsman	13-14	DAT03083	DAT03080	DAT03083	DAT03080
400 Sportsman HO	08-10	DAT08540	DAT08540	DAT08540	DAT08540
400 Sportsman HO	11-12	DAT03083	DAT03080	DAT03083	DAT03080
400 Xplorer	97-98	-	DAT08586	-	-
400 Xplorer	99-02	-	DAT08587	-	-
425 Xpedition	00-01	-	DAT08586	-	-
425 Xpedition	2002	-	DAT08587	-	-
450 Sportsman	06-07	DAT08546	DAT08545	DAT08583	DAT08583
500 Magnum	99-02	-	DAT08586	-	-
500 Scrambler	97-98	-	DAT08586	-	-
500 Scrambler	99-09	-	DAT08587	-	-
500 Scrambler	2010	DAT08546	DAT08545	-	-
500 Sportsman	1997	-	DAT08587	-	-
500 Sportsman	98-01	-	DAT08586	DAT08544	DAT08543
500 Sportsman EFI antes 25/07/06	06-07	DAT08547	DAT08586	DAT08583	DAT08583

500 Sportsman EFI	2006	DAT08546	DAT08545	DAT08583	DAT08583
500 Sportsman EFI	08-09	DAT08546	DAT08545	DAT03079	DAT03079
500 Sportsman HO	2001		DAT08586	DAT08544	DAT08543
500 Sportsman HO	2002		DAT08587	DAT08544	DAT08543
500 Sportsman HO	03-04		DAT08587	DAT08544	DAT08541
500 Sportsman HO	2005	DAT08585	DAT08587	DAT08544	DAT08541
500 Sportsman HO	2006	DAT08547	DAT08586	DAT08583	DAT08583
500 Sportsman HO	08-10	DAT08546	DAT08545	DAT03079	DAT03079
500 Sportsman HO	11-12	DAT03083	DAT03080	DAT03083	DAT03080
500 Sportsman HO	2013	DAT03082	DAT03082	DAT03083	DAT03080
500 Sportsman X2	2006	DAT08547	DAT08586	DAT08583	DAT08583
500 Sportsman X2 desde 25/07/06	06-07	DAT08546	DAT08545	DAT08583	DAT08583
500 Sportsman X2	08-09	DAT08546	DAT08545	DAT03079	DAT03079
550 Sportsman Touring	2010	DAT08546	DAT08545	DAT03081	DAT03081
550 Sportsman Touring	2011	DAT03083	DAT03082	DAT03081	DAT03081
550 Sportsman Touring EPS	10-11			DAT03081	DAT03081
550 Sportsman Touring EPS	12-14	DAT03083	DAT03082	DAT03081	DAT03081
550 Sportsman X2	2010	DAT08546	DAT08545	DAT03081	DAT03081
550 Sportsman X2	11-12	DAT03083	DAT03082	DAT03081	DAT03081
550 Sportsman X2	2013	DAT03083	DAT03082		
550 Sportsman XP	2009	DAT08546	DAT08545	DAT03079	DAT03079
550 Sportsman XP	2010			DAT03081	DAT03081
550 Sportsman XP	11-13	DAT03083	DAT03082	DAT03081	DAT03081
550 Sportsman XP EPS	2010	DAT08546	DAT08545	DAT03081	DAT03081
550 Sportsman XP EPS	11-13	DAT03083	DAT03082	DAT03081	DAT03081
570 Sportsman ACE	2015			DAT08583	DAT08583
600 Sportsman	03-05	-	DAT08587		
700 Ranger	2005	DAT08547	DAT08586	DAT08583	DAT08583
700 Ranger	06-07	DAT08585	DAT08587	DAT08583	DAT08583
700 Ranger	2008	DAT08585	DAT08585	DAT03079	DAT03079
700 Ranger	2009	DAT08546	DAT08545	DAT03079	DAT03079
700 Ranger Crew	08-09	DAT08585	DAT08585	DAT03079	DAT03079
700 Sportsman	02-04	-	DAT08587	DAT08544	DAT08541
700 Sportsman	2005	DAT08585	DAT08587	DAT08544	DAT08541
700 Sportsman antes 25/07/06	2006	DAT08547	DAT08586	DAT08583	DAT08583
700 Sportsman desde 25/07/06	06-07	DAT08546	DAT08545	DAT08583	DAT08583
700 Sportsman	2008	DAT08546	DAT08545	DAT03079	DAT03079
800 Ranger	2010	DAT08546	DAT08545	DAT03079	DAT03079
800 Ranger	11-14	DAT03081	DAT03081	DAT03083	DAT03080
800 RZR	08-10	DAT08585	DAT08585	DAT08545	DAT08545
800 RZR	11-14	DAT08585	DAT08585	DAT03083	DAT03080
800 RZR S	09-10	DAT08585	DAT08585	DAT03079	DAT03079
800 RZR S	11-14	DAT08585	DAT08585	DAT03083	DAT03080
800 RZR 4	2010	DAT08585	DAT08585	DAT03079	DAT03079
800 RZR 4	11-14	DAT08585	DAT08585	DAT03083	DAT03080
800 Sportsman	2005	DAT08585	DAT08587	DAT08583	DAT08541
800 Sportsman Neapco	2006	DAT08585	DAT08587	DAT08583	DAT08583
800 Sportsman GKN	2006	DAT08547	DAT08586	DAT08583	DAT08583
800 Sportsman desde 25/07/06	06-07	DAT08546	DAT08545	DAT08583	DAT08583
800 Sportsman	08-10	DAT08546	DAT08545	DAT03079	DAT03079
800 Sportsman	11-12	DAT03083	DAT03080	DAT03083	DAT03080
800 Sportsman	13-14	DAT03082	DAT03082	DAT03083	DAT03080
850 Scrambler	13-15	DAT03083	DAT03082	DAT03081	DAT03081
850 Scrambler					
850 Sportsman Touring	2010	DAT08546	DAT08545	DAT03081	DAT03081
850 Sportsman Touring	11-13	DAT03083	DAT03082	DAT03081	DAT03081
850 Sportsman XP	09-10	DAT08546	DAT08545	DAT03079	DAT03079
850 Sportsman XP	12-13	DAT03083	DAT03082	DAT03081	DAT03081
900 Ranger XP	2013			DAT03083	DAT03080
900 Ranger Diesel	11-14	DAT03081	DAT03081	DAT03083	DAT03080
900 RZR	11-14	DAT03083	DAT03080	DAT03083	DAT03080
900 RZR	2015	DAT08585	DAT08585		
1000 RZR	2015	DAT08585	DAT08585		

BRONCO Fuelles palier

FUELLE PALIER DELANTERO FUELLE PALIER TRASERO

SUZUKI	Año	Interior	Exterior	Interior	Exterior
LT-F 300 King Quad	96-98	DAT08547	DAT08541		
LT-F 300 King Quad	99-02		DAT08541		
LT 300 Quad Runner	94-95	DAT08547	DAT08541		
LT-A 400 Eiger	03-04	DAT085251	DAT085251		
LT-F 400 Eiger	05-07	DAT085251	DAT08541		
LT-A 450 King Quad	07-10	DAT03090	DAT085402		
LT-A 500 King Quad	2009	DAT03087	DAT03088		
LT-A 500 King Quad	11-12	DAT03090	DAT03088		
LT-A 500 King Quad PS	2009	DAT03087	DAT03088		
LT-A 500 King Quad PS	11-12	DAT03090	DAT03088		
LT-A 500 Quad Runner	98-01		DAT08541		
LT-A 500 Vinson	2002		DAT08541		
LT-A 500 Vinson	03-05	DAT085251	DAT085251		
LT-A 500 Vinson	2006	DAT085251	DAT08541		
LT-A 550 King Quad	2012	DAT03090	DAT085402		
LT-A 700 King Quad	05-07	DAT08547	DAT08547	DAT08547	DAT08547
LT-V 700 Twin Peaks	04-05	DAT085251	DAT08541		
LT-A 750 King Quad	08-12	DAT03090	DAT085402		
LT-A 750 King Quad PS	2009	DAT03087	DAT03088		
LT-A 750 King Quad PS	11-12	DAT03090	DAT03088		

FUELLE PALIER DELANTERO FUELLE PALIER TRASERO

YAMAHA	Año	Interior	Exterior	Interior	Exterior
YFM 250 Timberwolf	94-00	DAT08593	DAT08541		
YFM 350 Big Bear	87-96	DAT08593	DAT08541		
YFM 350 Big Bear	97-99	DAT08540	DAT08541		
YFM 350 Bruin	04-06	DAT08593	DAT08541		
YFM 350 Grizzly	07-11	DAT08593	DAT08541		
YFM 350 Grizzly	12-14	DAT085251	DAT08541		
YFM 350 Grizzly IRS	07-11	DAT085251	DAT08541	DAT08540	DAT08541
YFM 350 Grizzly IRS	2012	DAT085251	DAT08541		
YFM 350 Wolverine	95-05	DAT08540	DAT08541		
YFM 400 Big Bear	00-01	DAT08540	DAT08541		
YFM 400 Big Bear	02-06	DAT08593	DAT08541		
YFM 400 Big Bear	07-12	DAT085251	DAT08541	DAT08540	DAT08541
YFM 400 Grizzly	07-08	DAT08593	DAT08541	DAT08540	DAT08541
YFM 400 Kodiak semi.	93-04	DAT08593	DAT08541		
YFM 400 Kodiak	2005-2006	DAT08593	DAT08541	DAT08540	DAT08541
YFM 450 Grizzly	2007	DAT08540	DAT08541	DAT08540	DAT08541
YFM 450 Grizzly	08-14	DAT085251	DAT08541	DAT08540	DAT08541
YFM 450 Kodiak	03-04	DAT08540	DAT08541		
YFM 450 Kodiak	05-06	DAT08540	DAT08541	DAT08540	DAT08541
YFM 450 Wolverine	06-08	DAT08593	DAT08541		
YXR 450 Rhino	06-09	DAT085251	DAT08542	DAT08540	DAT08542
YFM 550 Grizzly	09-11	DAT08593	DAT08547	DAT08593	DAT08547
YFM 550 Grizzly	2012	DAT08593	DAT08547		
YFM 600 Grizzly	98-01	DAT08540	DAT08541		
YFM 660 Grizzly	2002	DAT08540	DAT08541	DAT08540	DAT08541
YFM 660 Grizzly	2003	DAT085251	DAT085251	DAT08540	DAT08541
YFM 660 Grizzly	04-08	DAT085251	DAT08541	DAT08540	DAT08541
YXR 660 Rhino	2004	DAT08540	DAT08541	DAT08540	DAT08541
YXR 660 Rhino	05-07	DAT085251	DAT08542	DAT08540	DAT08542
YFM 700 Grizzly	07-11	DAT08593	DAT08547	DAT08593	DAT08547
YFM 700 Grizzly	2012	DAT08593	DAT08547	DAT08593	
YXR 700 Rhino	08-09	DAT08540	DAT08542	DAT08540	DAT08542
YXR 700 Rhino	11-13	DAT08540		DAT08540	DAT08542



DAT08504

DAT08505



DAT08506

DAT08511



DAT08512

DAT08521



DAT08522

DAT08523



DAT08525

DAT08540



DAT08541

DAT08542



DAT08543

DAT08544

RUEDAS Y NEUMÁTICOS

MOTOR

ADMISIÓN / ESCAPE
REFRIGERACIÓN

ELÉCTRICO

SUSPENSIÓN / DIRECCIÓN

FRENOS

TRANSMISIÓN

CONTROLES Y MANDOS

CHASIS

ACCESORIOS



Cardan completo



CAN AM	FRONTAL			TRASERO	
	Año	Referencia	P.V.P.	Referencia	P.V.P.
450 Outlander	2015	PDC8020		PDC8021	
450 Outlander MAX	2015	PDC8020		PDC8022	
500 Outlander	13-15			PDC8008	496,02
500 Outlander MAX	13-15			PDC8009	496,02
500 Renegade	2008			PDC8023	
500 Renegade	13-15			PDC8008	496,02
650 Outlander	13-15			PDC8008	496,02
650 Outlander MAX	13-15			PDC8009	496,02
800 Outlander	2008			PDC8023	
800 Outlander	13-15			PDC8008	496,02
800 Outlander MAX	06-11			PDC8024	
800 Outlander MAX	13-15			PDC8009	496,02
800 Renegade	2008			PDC8023	
800 Renegade	13-15			PDC8008	496,02
1000 Maverick	13-14	PDC8012	418,82	PDC8017	
1000 Maverick	2015	PDC8012	418,82		
1000 Outlander	13-14			PDC8006	496,02
1000 Outlander	2015			PDC8008	496,02
1000 Outlander XMR	13-14			PDC8013	496,02
1000 Outlander MAX	13-14			PDC8007	551,38
1000 Outlander XMR	2015			PDC8009	496,02
1000 Renegade	13-14			PDC8006	496,02
1000 Renegade	2015			PDC8008	496,02

POLARIS	FRONTAL			TRASERO	
	Año	Referencia	P.V.P.	Referencia	P.V.P.
Sportsman ACE	14-15	PDC1011			
RZR 570	12-15	PDC1003	658,31		
RZR 800	08-10	PDC1002	615,30		
RZR 800	11-14	PDC1001	615,30		
RZR 800 S	09-10	PDC1002	615,30		
RZR 800 S	11-14	PDC1001	615,30		
Ranger 900 CREW	14-15	PDC1005	660,49	PDC1006	1044,04
Ranger 900 XP	13-15	PDC1003	658,31		
RZR 900	11-14	PDC1022			
RZR 900	2015	PDC1014		PDC1015	
RZR 900 "4"	12-14	PDC1023			
RZR 900 "4"	2015	PDC1012		PDC1015	
RZR 1000 XP	2015			PDC1013	
RZR 1000 XP 4	2014	PDC1012		PDC1013	

YAMAHA	FRONTAL			TRASERO	
	Año	Referencia	P.V.P.	Referencia	P.V.P.
YFM 660 Grizzly	02-08	PDC6001	364,00		



Kit retenes grupo diferencial

P.V.P
18



CAN AM	Año	Referencia delantera	Referencia trasera
Outlander 330	04-05	DAT03588	DAT03588
Outlander 400	03-05	DAT03588	DAT03588
Outlander 400	06-11	DAT03588	DAT03589
Outlander 400	2012	DAT03588	DAT03590
Outlander 500	07-11	DAT03588	DAT03589
Outlander 500	2012	DAT03588	DAT03590
Outlander 500	13-14	DAT03588	
Renegade 500	08-11	DAT03588	DAT03589
Renegade 500	12-13	DAT03588	DAT03590
Renegade 500	2014	DAT03588	
Traxter 500	99-05	DAT03588	
Outlander 650	06-11	DAT03588	DAT03589
Outlander 650	12-13	DAT03588	DAT03590
Outlander 650	2014	DAT03588	
Quest 650	02-04	DAT03588	
Traxter 650	04-05	DAT03588	
Commander 800	11-13	DAT03588	DAT03590
Outlander 800	06-11	DAT03588	DAT03589
Outlander 800	2013	DAT03588	DAT03590
Outlander 800	12-14	DAT03588	
Outlander 800 XMR/MAX	11-12	DAT03588	DAT03590
Renegade 800	07-11	DAT03588	DAT03589
Renegade 800	12-13	DAT03588	DAT03590
Renegade 800	2014	DAT03588	
Commander 1000	11-13	DAT03588	DAT03590
Maverick 1000	2013	DAT03588	
Outlander 1000	13-14	DAT03588	DAT03590
Outlander STD XT 1000	12-14	DAT03588	DAT03590
Outlander STD XT 1000	2014	DAT03588	
Renegade 1000	12-13	DAT03588	DAT03590
Renegade 1000	2014	DAT03588	

HONDA	Año	Referencia delantera	Referencia trasera
TRX 500 Foreman	04-14	DAT03591	DAT03592
TRX 650 Rincon	03-05	DAT03591	DAT03593
TRX 680 Rincon	06-14	DAT03591	DAT03593

KAWASAKI	Año	Referencia delantera	Referencia trasera
KVF 360 Prairie	03-13	DAT03585	
KVF 650 Prairie	02-03	DAT03585	DAT03586
KV F650 Brute force	05-13	DAT03585	DAT03586
KVF 650i Brute force	06-13	DAT03585	DAT03587
KVF 700 Prairie	04-06	DAT03585	DAT03586
KFX 700 V-Force	04-06		DAT03586
KVF 750 Brute Force	05-14	DAT03585	DAT03587
KVF 750 Brute Force EPS	12-14	DAT03585	DAT03587

SUZUKI	Año	Referencia delantera	Referencia trasera
LT-V 700F Twin Peaks	04-06	DAT03585	DAT03586

YAMAHA	Año	Referencia delantera	Referencia trasera
YFM 350 Grizzly IRS	07-11	DAT03582	
YFM 400 Big Bear IRS	07-12	DAT03582	
YFM 450 Kodiak	03-06	DAT03582	
YFM 450 Grizzly	07-14	DAT03582	
YFM 550 Grizzly	09-14	DAT03582	DAT03584
YFM 600 Grizzly	2002	DAT03582	DAT03583
YFM 660 Grizzly	02-08	DAT03582	DAT03583
YFM 700 Grizzly	07-14	DAT03582	DAT03584

CONTROLES Y MANDOS



EMGO Paramanos

Para proteger las manos de las piedras o del frío. Fáciles de montar. La brida de sujeción al manillar es de \varnothing 22mm.

Referencia	Descripción	P.V.P.
E79-97937	Paramanos Azul Yamaha	23,96
E79-97931	Paramanos Rojo Honda	23,96
E79-97934	Paramanos Negro	23,96
E79-97936	Paramanos Transparente	23,96
E79-97930	Paramanos Blanco	23,96
E79-97935	Paramanos Carbono	26,81
E79-97939	* Recambio anclajes	9,90

* Los pilotos que sustituyan el manillar y no deseen perder los protectores de manos, disponen de los soportes interiores del manillar como recambio.



PSYCHIC Paramanos

Referencia	Descripción	P.V.P.
DMX12027BU	Paramanos Azul Yamaha	28,21
DMX12027RD	Paramanos Rojo Honda	28,21
DMX12027BK	Paramanos Negro	28,21
DMX12027YL	Paramanos Amarillo	28,21
DMX12027WI	Paramanos Blanco	28,21
DMX12027GN	Paramanos Verde	28,21



XPEED Manillares

Manillares de hierro y aluminio.
Manillares de diámetro 22 y de diámetro variable.
Manillares color aluminio y de colores.

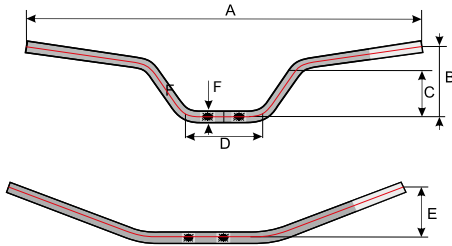

Referencia	Descripción	Imagen	A	B	C	D	E	F	P.V.P.
RY010A	Aluminio. Xpeed	A	773	110	87	175	97	22	38,19
RY010B	Aluminio. Xpeed	B	773	110	87	175	97	28,6	40,44
RY030A	Aluminio. Xpeed	A	785	140	105	155	100	22	38,19
RY030B	Aluminio. Xpeed	B	785	140	105	155	100	28,6	40,44
RS010A	Aluminio. Xpeed	A	790	142	105	200	90	22	38,19
RS010B	Aluminio. Xpeed	B	790	142	105	200	90	28,6	40,44

Accesorios manillares



Referencia	Descripción	P.V.P.
E99-96800	Protector varilla manillar	4,32



Referencia	Descripción	P.V.P.
RY100A	Varilla manillar Ø 22 Xpeed	13,80

EMGO Elevadores manillar

Eleva el manillar económicamente y sin trabajo, si eres alto podrás conducir más cómodamente y sin doblar tan pronunciadamente la espalda.

Fabricados con aluminio AL 6061

Referencia	Descripción	Color	P.V.P.
DMX081101	de Ø 22 mm a 22 mm, 2 cm mas alto	aluminio	31,14
DMX081681	de Ø 22 mm a 22 mm, 2 cm mas alto	negro	33,38
DMX08169	de Ø 22 mm a 22 mm, 2 a 4 cm mas alto	aluminio	41,95
DMX08110	de Ø 22 mm a 28,6 mm, 2 cm mas alto	aluminio	31,14
DMX08168	de Ø 22 mm a 28,6 mm, 2 cm mas alto	negro	33,38
E23-08191	de Ø 22 mm a 28,6 mm, 2 cm mas alto	aluminio	45,12
DMX081691	de Ø 28,6 mm a 28,6 mm, 2 a 4 cm mas alto	aluminio	44,76
DMX08151	Elevador manillar moto Ø 28,6 mm	aluminio	36,12

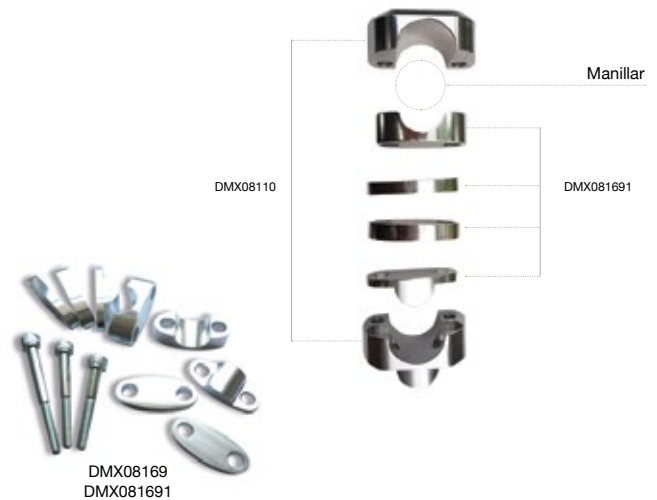

E23-08191



DMX08110
DMX081101



DMX08169
DMX081691



DMX08168
DMX081681



DMX08151

XPEED Desconectores

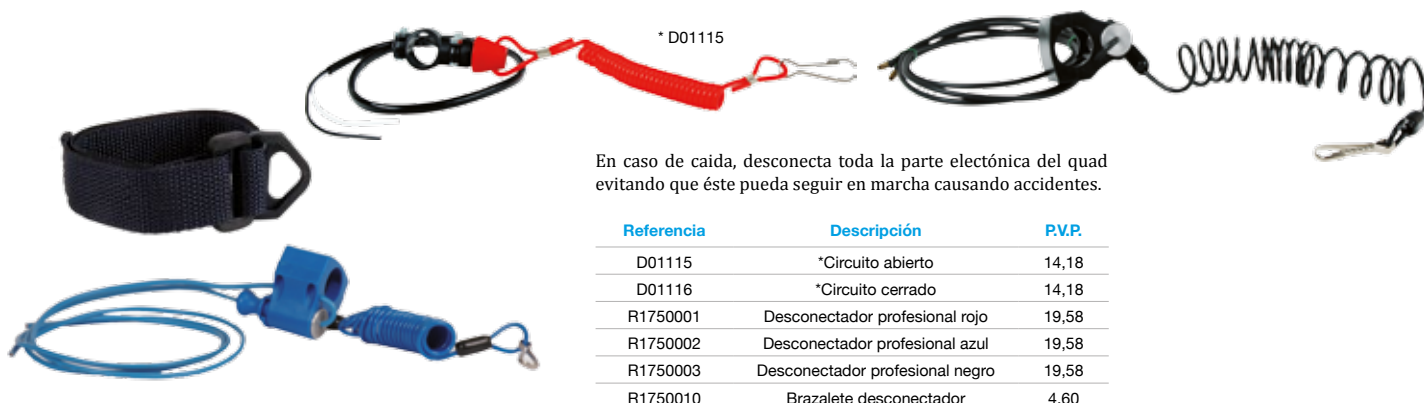

En caso de caída, desconecta toda la parte electrónica del quad evitando que éste pueda seguir en marcha causando accidentes.

Referencia	Descripción	P.V.P.
D01115	*Circuito abierto	14,18
D01116	*Circuito cerrado	14,18
R1750001	Desconector profesional rojo	19,58
R1750002	Desconector profesional azul	19,58
R1750003	Desconector profesional negro	19,58
R1750010	Brazaletes desconector	4,60



Kit reparación cable embrague/acelerador

El kit lo compone un cable de 1,5mm de diámetro y 2m de largo, un cable de 1,2mm de diámetro y 2m de largo, más siete piezas diferentes de terminación.

Referencia	P.V.P.
DMP05092	5,28



XPEED Desmultiplicador embrague

Referencia	P.V.P.
DAT05700	20,93



XPEED Calefacción de manos y gatillo

P.V.P.
19,60

DAT12750
Calefacción gatillo



P.V.P.
28,20

Ofrece una temperatura de confort en las manos. Dispone de dos intensidades. Fácil montaje. Se puede servir con dos modelos de interruptor.



P.V.P.
6,90

D1216604
1 Interruptor de recambio

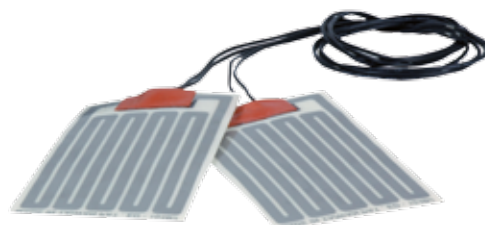

EMIGO Aceleradores de puño estándar



D101053



D101054



D101057

	Giro	Referencia	P.V.P.
TIPO CR PRO	170° 1/2	D101053	15,64
TIPO VORTEX	95° 1/4	D101054	21,33
TIPO TURBO	150° 1/3	D101057	16,59

XPEED Acelerador de gatillo

Referencia	Descripción	P.V.P.
DAT08404	Honda Deportivos	29,77
DAT08405	Yamaha Breeze 90-01	22,83
DAT08406	Yamaha Blaster / Banshee	29,77
DAT08407	Deportivos Yamaha	33,82



DAT08404



DAT08406



DAT08405



DAT08407

XPEED Empuñaduras



R520090



R520110
R520111



R520113



R520050



R520122



R520150
R520153



R520160



R520120
R520121



R520170
R520171

Referencia	Descripción	P.V.P.
R520050	Puños de goma Grises 22 - 22	7,36
R520090	Puños de goma Grises 22 - 22	7,36
R520110	Puños de goma Grises 22 - 22	7,36
R520111	Puños de goma Grises 22 - 24	7,36
R520113	Puños de goma Negros 22 - 24	7,36
R520120	Puños de goma Grises 22 - 22	7,36
R520121	Puños de goma Grises 22 - 24	7,36

Referencia	Descripción	P.V.P.
R520122	Puños de goma Negros 22 - 22	7,36
R520150	Puños de goma Negros 22 - 22	7,36
R520153	Puños de goma Negros 22 - 24	7,36
R520160	Puños de goma Grises 22 - 22	7,36
R520170	Puños de goma Azules 22 - 22	7,36
R520171	Puños de goma Azules 22 - 24	7,36

CONTROLES Y MANDOS



P.V.P Según color de referencia

P.V.P
12,60

P.V.P
13,95

P.V.P
15,40

Cables 5 cm más largos

4PLAY Cables acelerador y embrague

	Año	Referencia	ACELERADORES DE PUÑO		CABLE EMBRAGUE
			TIPO CR PRO	TIPO VORTEX	
CAN AM					
Outlander 330	03-05	D1011032	D1011032		
Outlander 400	04-07	D1011032	D1011032		
Outlander 500	2007		D1011031		
Outlander 650	2007		D1011031		
Outlander 800	06-07		D1011031		

	Año	Referencia	ACELERADORES DE PUÑO		CABLE EMBRAGUE
			TIPO CR PRO	TIPO VORTEX	
HONDA					
TRX 250 Sportrax	06-12	D102546			
TRX 300 EX	93-06	D102135	D101235		D102108
TRX 300 EX	07-08	D102135	D101235		D102108
TRX 350 Rancher	00-06	D102375			
TRX 400 Rancher	95-07	D102375			
TRX 400 EX Sportrax	99-04	D102517	D101706		D102382
TRX 400 EX Sportrax	05-07	D102517			D102518
TRX 400 EX Sportrax	08-12	D102517			D102548
TRX 420 Rancher	07-11	D102375			
TRX 450 R Sportrax	04-09	D102408		D1011013	D102405
TRX 650 Rincon	03-05	D102375	D101609		
TRX 680 Rincon	06-12	D102375	D101609		
TRX 700 X	08-09	D102568			D102572

	Año	Referencia	ACELERADORES DE PUÑO		CABLE EMBRAGUE
			TIPO CR PRO	TIPO VORTEX	
KAWASAKI					
KFX 400	03-06	D104228	D101459	D101458	D104232
KFX 450 R	08-12	D103376			
KVF 650 Brute Force	02-13	D103350			
KSV 700 V-Force	04-09	D103350			
KVF 700	04-06	D103350			
KVF 750i Brute Force	05-07	D103362			
KVF 750i Brute Force	08-12	D103379			

	Año	Referencia	ACELERADORES DE PUÑO		CABLE EMBRAGUE
			TIPO CR PRO	TIPO VORTEX	
POLARIS					
300 Hawkeye	06-11	D110090			
325 Magnum	01-02	D110090			
325 Trail Boss	02-03	D110090			
325 Expedition	2002	D110090			
330 Trail Boss	03-07	D110090			
400 Sportsman	01-12	D110090			
450 Expedition	00-02	D110090			
450 Sportsman	06-07	D110090			
500 Predator Troy	03-07	D110090			DAT05308
500 Magnum	01-03	D110090			
500 Scrambler	99-11	D110090			
500 Outlaw	06-07	D110090			DAT05308
500 Sportsman/RSE/HO	99-12	D110090			
500 Sportsman EFI	06-07	D110118			
525 Outlaw	07-08	D110120			
600 Sportsman Twin	03-05	D110090			
700 Sportsman Twin	02-06	D110090			
700 Sportsman Twin	04-07	D110107			
800 Sportsman Twin	05-12	D110107			



P.V.P Según color de referencia

P.V.P
12,60

P.V.P
13,95

P.V.P
15,40

4PLAY Cables acelerador y embrague

Cables 5 cm más largos

	Año	REFERENCIA	ACELERADORES DE PUÑO		CABLE EMBRAGUE
			TIPO CR PRO	TIPO VORTEX	
SUZUKI					
160 LT Quadrunner	91-01	D104118			
250 LT-F Ozark	01-05	D104215			
400 LT-A Eiger	02-07				
400 LT-F Eiger	02-07				
400 LT-Z QuadSport	03-08	D101458			
400 LT-Z QuadSport	03-08	D104228	D101459	D101458	D104232
400 LT-Z QuadSport	09-12	D104302			D104232
450 LT-R QuadSport	06-09	D104258		D101839	D104262
450 LT-A King Quad	07-09	D104248			
700 LTV Twin Peaks	2005	D103350			
700 LT-A King Quad	05-07	D104248			
750 LT-A King Quad	08-09	D104248			
	Año	REFERENCIA	ACELERADORES DE PUÑO		CABLE EMBRAGUE
			TIPO CR PRO	TIPO VORTEX	
YAMAHA					
125 Breeze	89-04	D105171			
200 Blaster	88-06	D105118			D105119
250 Raptor	08-12	D105363			
350 Warrior	93-04	D105153			D105092
350 Raptor	04-12	D105327		D1011015	D105328
350 Banshee	87-06	D105136			D105111
350 Wolverine	06-09	D105282			
350 Bruin	05-06	D105282			
400 Kodiak Ultrama	00-06	D105282			
450 YFZ	04-12	D105315	D101473	D101472	D105304
450 YFZ-R	09-12	D105383	D1011135		D105387
450 Grizzly	07-11	D105282			
450 Wolverine	06-10	D105282			
550 Grizzly	09-12	D105352			
660 Raptor	01-05	D105241			D105271
660 Grizzly	02-08	D105284			
700 Raptor	06-12	D105337	D1011030		D105338
700 Grizzly	07-12	D105352			



RUEDAS Y NEUMÁTICOS

MOTOR

ADMISIÓN / ESCAPE
REFRIGERACIÓN

ELÉCTRICO

SUSPENSIÓN / DIRECCIÓN

FRENOS

TRANSMISIÓN

CONTROLES Y MANDOS

CHASIS

ACCESORIOS

BRONCO Manetas de embrague y freno



DAT08069SL



DAT08180

HONDA	Año	EMBRAGUE		FRENO	
		Referencia	P.V.P.	Referencia	P.V.P.
TRX 250 Recon	97-01	DAT08165	6,44	DAT08108*	6,93
TRX 250 EX Sportrax	01-05	DAT08152SL	10,73	DAT08173	5,94
TRX 250 EX Sportrax	06-16	DAT08165	6,44	DAT08173	5,94
TRX 250 Recon	02-13	DAT08152	12,05	DAT08107	6,44
TRX 300 Fourtrax	88-00	DAT08152	12,05	DAT08108*	6,93
TRX 300 EX Sportrax	93-06	DAT08166	10,07	DAT08173	5,94
TRX 300 EX Sportrax	07-08	DAT08165	6,44	DAT08173	5,94
TRX 350 Rancher	00-03	DAT08152	12,05	DAT08184	
TRX 350 Rancher	04-06	DAT08152	12,05	DAT08108*	6,93
TRX 400 Foreman	95-03	DAT08152	12,05	DAT08108*	6,93
TRX 400 Rancher	04-07	DAT08167	9,24	DAT08154	9,24
TRX 400 EX Sportrax	08-14	DAT08165	6,44	DAT08173	5,94
TRX 420 Rancher	07-14	DAT08152	12,05	DAT08154	9,24
TRX 450 Rancher	98-04	DAT08152	12,05	DAT08108*	6,93
TRX 450 R	04-14	DAT08165	6,44	DAT08174	13,04
TRX 500 Rubicon	05-14	DAT08168	14,19	DAT08154	9,24
TRX 650 Rincon	03-05	DAT08167	9,24	DAT08154	9,24
TRX 680 Rincon	06-16	DAT08167	9,24	DAT08154	9,24
TRX 700 XX	08-09	DAT08165	6,44	DAT08175	7,92

KAWASAKI	Año	EMBRAGUE		FRENO	
		Referencia	P.V.P.	Referencia	P.V.P.
KLF 220 Bayou	88-96	DAT08086	6,11		
KSF 250 Mojave	89-04	DAT08086	6,11	DAT08085	5,94
KEF 300 Lakota	95-99	DAT08169	7,92	DAT08085	5,94
KLF 300 Bayou	91-02	DAT08169	7,92	DAT08085	5,94
KVF 300 Prairie	1999	DAT08169	7,92	DAT08085	5,94
KVF 360 Prairie	03-12	DAT08171	7,59	DAT08176	6,44
KLF 400 Bayou	93-99	DAT08169	7,92	DAT08085	5,94
KVF 400 Prairie	97-02	DAT08169	7,92	DAT08085	5,94
KVF 650 Bute Force	02-03	DAT08171	7,59	DAT08176	6,44
KVF 650 Bute Force	03-13	DAT08171	7,59	DAT08176	6,44
KFX 700 V-Force	04-09	DAT08170	8,42	DAT08176	6,44
KVF 750 Bute Force	05-16	DAT08171	7,59	DAT08176	6,44

KTM	Año	EMBRAGUE		FRENO	
		Referencia	P.V.P.	Referencia	P.V.P.
450 SX	09-12	DMX08457	21,30	DAT08155	24,68
450 SX-F	09-13			DAT08155	24,68
450 XC	2009	DMX08457	21,30	DAT08155	24,68
505 SX	09-10	DMX08457	21,30	DAT08155	24,68
525 XC	2009	DMX08457	21,30	DAT08155	24,68

SUZUKI	Año	EMBRAGUE		FRENO	
		Referencia	P.V.P.	Referencia	P.V.P.
LT-F 160 Quadruner	91-04			DAT08084	8,58
LT-F 250 Quadruner	88-02	DAT08082	6,93	DAT08065	7,59
LT-F 300 King Quad	99-02	DAT08082	6,93	DAT08065	7,59
LT-Z 400 Quadsport	03-08	DAT08068SL	6,44	DAT08153	6,44
LT-Z 400 Quadsport	09-14	DAT08158	6,44	DAT08157	16,34
LT-A 500 Quadruner	00-01	DAT08082	6,93	DAT08065	7,59
LT-F 500 Quadruner	98-02	DAT08082	6,93	DAT08065	7,59

YAMAHA	Año	EMBRAGUE		FRENO	
		Referencia	P.V.P.	Referencia	P.V.P.
YFA 125 Breeze	89-01	DAT08067	6,93	DAT08075	6,93
YFA 125 Breeze	02-03	DAT08069	6,11	DAT08076	6,11
YFM 125 Grizzly	04-13	DAT08069	6,11	DAT08076	6,11
YFS 200 Blaster	90-93	DAT08077*	6,93	DAT08073	10,23
YFS 200 Blaster	94-02	DAT08070		DAT08073	10,23
YFS 200 Blaster	03-07	DAT08068SL	6,44	DAT08179	6,77
YFM 250 Beartracker	99-00	DAT08069SL	6,11	DAT08076	6,11
YFM 250 Big Bear	07-09	DAT08069SL	6,11	DAT08178	6,77
YFM 250 Bruin	05-06	DAT08069SL	6,11	DAT08178	6,77
YFM 350 Big Bear (semiauto.)	87-99	DAT08069SL	6,11	DAT08072	6,11
YFM 350 Bruin	04-06	DAT08069SL	6,11	DAT08178	6,77
YFM 350 Grizzly	07-14	DAT08069SL	6,11	DAT08178	6,77
YFM 350 Raptor	04-09	DAT08069SL	6,11	DAT08179	6,77
YFM 350 Wolverine	95-01	DAT08068BK	6,44	DAT08071	6,93
YFM 350 Warrior	87-01	DAT08068BK	6,44	DAT08071	6,93
YFM 350 Warrior	02-04	DAT08068SL	6,44	DAT08179	6,77
YFZ 350 Banshee	87-01	DAT08068SL	6,44	DAT08071	6,93
YFZ 350 Banshee	02-06			DAT08179	6,77
YFM 400 Kodiak	93-99	DAT08069SL	6,11	DAT08072	6,11
YFM 400 Big Bear	02-04	DAT08069SL	6,11	DAT08178	6,77
YFM 400 Big Bear	02-12	DAT08069SL	6,11	DAT08178	6,77
YFM 400 Kodiak	00-01	DAT08067	6,93		
YFM 400 Grizzly	07-08	DAT08069SL	6,11	DAT08178	6,77
YFZ 450	04-05	DMX08404	5,57	DAT08162	10,82
YFZ 450	07-13	DMX08404	5,57	DAT08160*	
YFZ 450 R	09-16	DMX08404	5,57	DAT08180	15,18
YFM 450 Grizzly	07-14	DAT08069SL	6,11	DAT08178	6,77
YFM 450 Wolverine	06-09	DAT08069SL	6,11	DAT08178	6,77
YFM 600 Grizzly	98-01	DAT08069SL	6,11	DAT08072	6,11
YFM 660 Raptor	01-05	DAT08068SL	6,44	DAT08179	6,77
YFM 660 Grizzly	02-08	DAT08070	4,50	DAT08178	6,77
YFM 700 Raptor	2006	DAT08069SL	6,11	DAT08179	6,77
YFM 700 Raptor	07-13	DAT08069SL	6,11	DAT08180	15,18
YFM 700 Raptor	14-16	DAT08069SL	6,11	DAT08182	8,42

CHASIS



BRONCO Fundas asiento

Diseñado para encajar perfectamente en el asiento original de tu ATV

Color NEGRO, resistente a los rayos ultravioleta, resistente al agua, proporciona tracción adicional bajo cualquier condición de conducción.

Incluye instrucciones para rápida y fácil instalación.

P.V.P
40,15

P.V.P
33,20

ARTIC CAT	Año	Referencia
400 todos	06-13	DAT04601
450 todos	11-13	DAT04601
500 todos	05-13	DAT04601
550 todos	10-13	DAT04601
650 todos	05-11	DAT04601
700 todos	06-13	DAT04601
1000 todos	10-13	DAT04601

CAN AM	Año	Referencia
Outlander 500 (Excep.MAX)	07-13	DAT04602
Renegade 500	08-15	DAT04603
Outlander 650 (Excep.MAX)	07-13	DAT04602
Outlander 800 (Excep.MAX)	06-13	DAT04602
Renegade 800	07-15	DAT04603
Outlander 1000	2013	DAT04602
Renegade 1000	12-15	DAT04603

HONDA	Año	Referencia
TRX 90	93-06	DAT04604
TRX 200	90-98	DAT04605
TRX 250 Recon	97-05	DAT04606
TRX 250 Fourtrax Recon	05-14	DAT04607
TRX 250 EX Sportrax	01-05	DAT04608
TRX 250 EX Sportrax	06-14	DAT04612
TRX 250 X	87-92	DAT04609
TRX 300 Fourtrax	88-04	DAT04610
TRX 300 EX	93-06	DAT04609
TRX 350 / 400 Fourtrax Rancher	00-03	DAT04620
TRX 350 / 400 Fourtrax Rancher	04-07	DAT04611
TRX 400 FW Foreman	95-01	DAT04624
TRX 400 Foreman / Fourtrax	95-03	DAT04613
TRX 400 EX Sportrax	99-07	DAT04614
TRX 420 Fourtrax Rancher	07-10	DAT04615
TRX 420 Fourtrax Rancher	11-13	DAT04616
TRX 450 S / ES Foreman	98-05	DAT04617
TRX 450 R	04-09	DAT04625
TRX 500 FW Rubicon	01-04	DAT04618
TRX 500 Foreman / Rubicon	05-14	DAT04619
TRX 500 Foreman	05-11	DAT04619
TRX 650 Rincon	03-05	DAT04621
TRX 680 Rincon	06-15	DAT04621

KAWASAKI	Año	Referencia
KFX 80	03-06	DAT04622
KLF 220 A Bayou	88-02	DAT04623
KLF 250 Bayou	02-10	DAT04623
KLF 300 B Bayou	89-04	DAT04629
KLF 300 C 4x4 Bayou	89-05	DAT04626
KVF 300 / 400 Prairie	97-02	DAT04627
KVF 360 Prairie	02-13	DAT04628
KLF 400 4x4 Bayou	93-99	DAT04629
KXF 400	03-06	DAT04630
KFX 450 R	08-14	DAT04631
KVF 650 Brute Force (carbu)	05-14	DAT04632
KVF 650I Brute Force	05-14	DAT04633
KVF 650 Prairie	03-07	DAT04632
KVF 700 Prairie	03-07	DAT04632
KFX 700	03-09	DAT04634
KVF 750I Brute Force	05-14	DAT04633

POLARIS	Año	Referencia
250 todos	90-95	DAT04635
300 Xplorer	96-99	DAT04636
300 Xpress	96-99	DAT04636
325 Magnum	00-02	DAT04636
325 Xpedition	00-02	DAT04636
330 Trail Boss	02-09	DAT04637
335 Sportsman	99-00	DAT04636
400 todos	90-95	DAT04635
400 Sportsman	96-02	DAT04636
400 Sportsman	01-04	DAT04637
400 Sportsman	2005	DAT04638
400 Xplorar	96-02	DAT04636
400 Hawkeye HO	11-14	DAT04638
400 Sportsman HO	2013	DAT04638
425 Xpedition	00-02	DAT04636
450 Sportsman	06-07	DAT04638
500 Diesel	99-00	DAT04636
500 Sportsman	03-04	DAT04637
500 Sportsman	05-13	DAT04638
550 Sportsman	09-14	DAT04639
600 Sportsman	03-04	DAT04637
700 Sportsman	02-03	DAT04636
700 Sportsman	03-04	DAT04637
700 Sportsman	05-07	DAT04638
800 Sportsman	05-13	DAT04638
850 Sportsman XP	09-10	DAT04638
850 Sportsman XP	11-14	DAT04639
1000 Sportsman	2015	DAT04639

SUZUKI	Año	Referencia
LT 160 Quad Runner	03-04	DAT04640
LT-F 160 Quad Runner	89-01	DAT04640
LT 250	91-95	DAT04641
LT 250 R	87-93	DAT04642
LT-F 250 F	99-02	DAT04643
LT-F 250 Ozark	02-09	DAT04644
LT-F 250 Quad Runner	87-98	DAT04645
LT-Z 250 Quadsport	03-09	DAT04646
LT-F 300 F	99-02	DAT04643
LT-A 400 Eiger	02-07	DAT04647
LT-F 400 Eiger	02-07	DAT04647
LT-A 400 King Quad	08-11	DAT04648
LT-F 400 King Quad	08-11	DAT04648
LT-Z 400 Quadsport	03-13	DAT04630
LT-A 450 King Quad	06-09	DAT04649
LT-A 500 King Quad	09-15	DAT04649
LT-A 500 F/S Vinson	02-07	DAT04651
LT-F 500 F	98-02	DAT04652
LT 500 R	87-90	DAT04653
LT-A 550 King Quad	2012	DAT04649
LT-A 700 King Quad	05-11	DAT04649
LT-A 750 King Quad	08-15	DAT04649

YAMAHA	Año	Referencia
YFM 125 Grizzly	04-13	DAT04654
YFS 200 Blaster	88-06	DAT04655
YFB 250 Timberwolf	92-01	DAT04656
YFM 250 Beartracker	99-04	DAT04657
YFM 250 Big Bear	07-09	DAT04658
YFM 250 Bruin	05-06	DAT04658
YFM 250 Raptor	08-13	DAT04659
YFM 350 Wolverine	95-05	DAT04661
YFM 350 Big Bear	87-01	DAT04662
YZF 350 Banshee	87-06	DAT04663
YFM 350 Bruin	04-06	DAT04658
YFM 350 Grizzly	05-15	DAT04658
YFM 350 Raptor	04-13	DAT04665
YFM 400 Big Bear	00-06	DAT04666
YFM 400 Big Bear	07-12	DAT04667
YFM 400 Kodiak	93-95	DAT04676
YFM 450 Grizzly	05-16	DAT04658
YFM 450 Kodiak	00-06	DAT04658
YFM 550 Grizzly	09-11	DAT04668
YFM 550 Grizzly	12-14	DAT04669
YFM 600 Grizzly	97-01	DAT04670
YFM 660 Grizzly	02-08	DAT04671
YFM 660 R Raptor	01-05	DAT04672
YFM 700 Grizzly	07-11	DAT04668
YFM 700 Grizzly	12-14	DAT04669
YFM 700 R Raptor	06-12	DAT04673





X-21



X-25



X-99

XPEED Protectores aluminio para Quad deportivo

Los precios son para protectores en color de aluminio.
Bajo pedido de 3 semanas se puede entregar pintado o cincado, en color negro u otro, pero con un incremento de un 10% y previo pago.



X-61



X-00

P.V.P
84,62

P.V.P
91,07

P.V.P
38,49

P.V.P
48,27

P.V.P
88,80

		X-21 DEFENSA DELANTERA	X-25 DEFENSA DELANTERA	X-99 ANTI-VUELCO	X-61 PROTECTOR LATERAL	X-00 PROTECTOR DISCO CADENA
CAN AM						
	Año	Referencia	Referencia	Referencia	Referencia	Referencia
DS 250	06-12	P1658	P1758			
DS 650	00-07	P1627	P1727			
DS 450 EFI	08-14	P1622	P1722	P4822	P4322	P4122
HONDA						
	Año	Referencia	Referencia	Referencia	Referencia	Referencia
TRX 400 Sportrax	99-07	P167A	P177A			P4107
TRX 400 Sportrax	08-13	P167A	P177A			P4107
TRX 450 R	00-06	P1606	P1706	P4806		P4106
TRX 450 R	07-15	P1615	P1715	P4815	P4315	P4115
TRX 700	08-09	P1651	P1751	P4851		
KAWASAKI						
	Año	Referencia	Referencia	Referencia	Referencia	Referencia
KFX 400	03-06	P1613	P1713	P4813	P4313	P4113
KFX 450 R	08-13	P1605	P1705	P4805	P4305	P4105
KFX 700 V-Force	04-09	P1624	P1724	P4824		P4124
KTM						
	Año	Referencia	Referencia	Referencia	Referencia	Referencia
SX 450	09-10	P1617	P1717	P4817	P4317	P4117
XC 450	08-10	P1617	P1717	P4817	P4317	P4117
SX 525	09-10	P1617	P1717	P4817	P4317	P4117
XC 525	08-10	P1617	P1717	P4817	P4317	P4117
KYMCO						
	Año	Referencia	Referencia	Referencia	Referencia	Referencia
KXR 250		P1610	P1710	P4810		P4110
KXR 300		P1611	P1711	P4811		P4111
POLARIS						
	Año	Referencia	Referencia	Referencia	Referencia	Referencia
Outlaw 500	06-07	P1616	P1716	P4816		P4116
Predator 500	03-07	P1614	P1714	P4814		P4114
Scrambler 500	97-12	P1628	P1728			
Outlaw 525	07-11	P1616	P1716	P4816		P4144
SUZUKI						
	Año	Referencia	Referencia	Referencia	Referencia	Referencia
LT-Z 250	04-09	P1630	P1730	P4830		
LT-Z 400	03-08	P1602	P1702	P4802	P4302	P4148
LT-Z 400	09-12	P1602	P1702	P4848	P4348	P4148
LT-R 450	06-09	P1601	P1701	P4801	P4301	P4101
YAMAHA						
	Año	Referencia	Referencia	Referencia	Referencia	Referencia
YFS 200 Blaster	88-06	P1626	P1726	P4826		P4126
YFM 250 R	08-13	P1618	P1718	P4818		P4118
YFM 350 R	04-13	P1608	P1708	P4808	P4308	P4108
YFM 350 Warrior	87-04	P1631	P1731			P4131
YFZ 350 Banshee	87-06	P1623	P1723	P4823		P4123
YFZ 450	04-05	P1604	P1704	P4804	P4304	P414A
YFZ 450	2006	P1604	P1704	P4804	P4304	P414B
YFZ 450	07-13	P1604	P1704	P4804	P4304	P414C
YFZ 450 R	09-16	P1655	P1755	P4855	P4355	P4155
YFM 660 Raptor	01-05	P1609	P1709	P4809	P4309	P4109
YFM 700 Raptor	06-16	P1603	P1703	P4803	P4303	P4103



X-11
X-12



X-15



X-40

Las protecciones de plástico PEHD están fabricadas con material de 6 o 8 mm de alta densidad, confiriendo una dureza similar al aluminio pero indeformable

XPEED Protectores aluminio y PEHD para Quad deportivo

Los precios son para protectores en color de aluminio.

Bajo pedido de 3 semanas se puede entregar pintado o cincado, en color negro u otro, pero con un incremento de un 10% y previo pago.

P.V.P
81,92

P.V.P
81,92

P.V.P
71,63

P.V.P
105,12

P.V.P
17,50

X-11 PROTECTOR CHASIS PLÁSTICO PEHD	X-12 PROTECTOR CHASIS ALUMINIO	X-15 PROTECTOR TRAPECIOS PLÁSTICO PEHD	X-40 PROTECTOR PIES ALUMINIO	TIRAS RECAMBIO PROTECTOR PIES
-------------------------------------------	--------------------------------------	----------------------------------------------	------------------------------------	-------------------------------------

ARTIC CAT	Año	Referencia	Referencia	Referencia	Referencia	Referencia
DVX 400			P4012		P0112	P14112
CAN AM	Año	Referencia	Referencia	Referencia	Referencia	Referencia
DS 250	06-12				P0158	P14113
DS 650	00-07		P4022		P0122	P14110
DS 450 EFI	08-12				P0127	P14121
HONDA	Año	Referencia	Referencia	Referencia	Referencia	Referencia
TRX 400 Sportrax	99-07	P5807	P4007	P4507	P0107	P14127
TRX 400 Sportrax	08-13	P5807	P4007	P4507	P017A	P14127
TRX 450 R	00-06	P5806	P4006		P0106	P14110
TRX 450 R	07-13	P5815	P4015	P4515	P0115	P14113
TRX 700	08-09				P0151	P14106
KAWASAKI	Año	Referencia	Referencia	Referencia	Referencia	Referencia
KFX 400	03-06		P4013		P0113	P14112
KFX 450 R	08-13	P5805	P4005	P4505	P0105	P14106
KFX 700 V-Force	04-09		P4024		P0124	P14113
KTM	Año	Referencia	Referencia	Referencia	Referencia	Referencia
SX 450	09-10	P5817	P4017	P4517	P0117	P14119
XC 450	08-10	P5817	P4017	P4517	P0117	P14119
SX 525	09-10	P5817	P4017	P4517	P0117	P14119
XC 525	08-10	P5817	P4017	P4517	P0117	P14119
KYMCO	Año	Referencia	Referencia	Referencia	Referencia	Referencia
KXR 250			P4010		P0110	P14105
KXR 300			P4011		P0111	P14105
POLARIS	Año	Referencia	Referencia	Referencia	Referencia	Referencia
Outlaw 500	06-07		P4016		P0116	P14106
Predator 500	03-07		P4014		P0114	P14107
Outlaw 525	07-11		P4044		P0144	P14107
SUZUKI	Año	Referencia	Referencia	Referencia	Referencia	Referencia
LT-Z 250	04-09				P0130	P14105
LT-R 450	06-09		P4002	P4502	P0102	P14101
LT-Z 400	03-08		P4048	P4548	P0148	P14112
LT-Z 400	09-12		P4001	P4501	P0101	P14112
YAMAHA	Año	Referencia	Referencia	Referencia	Referencia	Referencia
YFS 200 Blaster	88-06				P0126	P14116
YFM 250 R	08-12	P5818	P4018	P4518	P0118	P14116
YFM 350 R	04-13	P5808	P4008		P0108	P14113
YFM 350 Warrior	87-04		P4031		P0131	P14113
YFZ 350 Banshee	87-06		P4023		P0123	P14116
YFZ 450	03-13	P5804	P4004	P4504	P0104	P14106
YFZ 450 R	09-16	P5855	P4055	P4555	P0155	P14106
YFM 660 Raptor	01-05	P5809	P4009	P4509	P0109	P14111
YFM 700 Raptor	06-14	P5803	P4003	P4503	P0103	P14106
YFM 700 Raptor	15-16	P5803	P4003	P453A	P0103	P14106

XPEED Tiras de recambio para protector pies

P.V.P
17,50



P14101



P14105



P14106



P14107



P14110



P14111



P14112



P14113



P14116



P14119



P14121



P14127



RUEDAS Y NEUMÁTICOS

MOTOR

ADMISIÓN / ESCAPE
REFRIGERACIÓN

ELÉCTRICO

SUSPENSIÓN / DIRECCIÓN

FRENOS

TRANSMISIÓN

CONTROLES Y MANDOS

CHASIS

ACCESORIOS

BRONCO 10 Remaches plástico

Remache para los plásticos de los ATV-UTV.
Se sirve en bolsas de 10 unidades. Precio por bolsa.

Referencia	A	B	C	
DAT04025	8,0	15	22	Can Am
DAT04290	7,8	20	22	Honda / Kawasaki / Suzuki / Yamaha
DAT04291	7,7	19,5	20,6	Honda / Kawasaki / Suzuki / Yamaha
DAT04292	6,8	19,8	11	
DAT04293	6,0	14	12,2	
DUP12040	5,9	12	15,5	
DUP12440	3,85	17,17	24,7	Articat / Polaris
DUP12443	6	17,8	22,7	Polaris
DUP12444	2,8	12,05	25,83	Polaris
DUP12445	4,7	12,25	25,7	Polaris
DUP12446	8,5	18,75	15	Can Am

Referencia	A	B	C
DUP12447WI	9,3	13	8
DUP12447BK	9,3	13	8
DUP12449	7,4	13	8,4
DUP12451WI	11,4	15	8,45
DUP12451BK	11,4	15	8,45

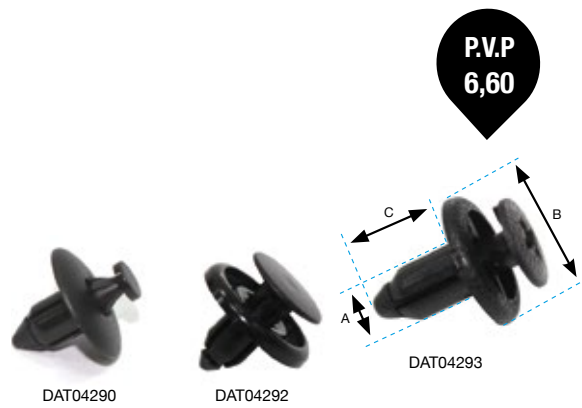

2 Gomas sujeción capó

Referencia	P.V.P.
D1213501	5,30
D1213401	5,30
DSM12327	5,92



XPEED Protectores aluminio para ATV

Los precios son para protectores en color de aluminio.
Bajo pedido de 3 semanas se puede entregar pintado o cincado, en color negro u otro, pero con un incremento de un 10% y previo pago.

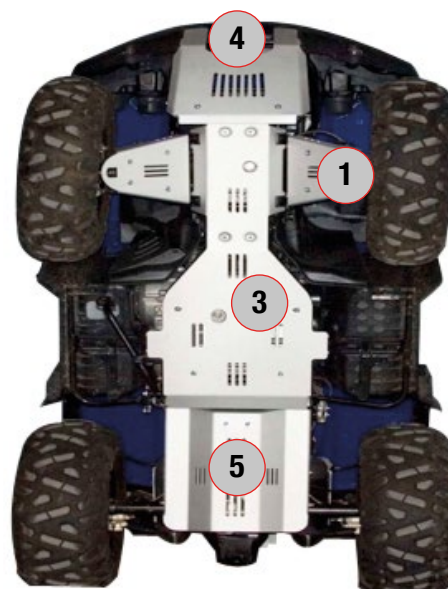

		4 X-71 PROTECTOR CÁRTER FRONTAL		3 X-72 PROTECTOR CÁRTER CENTRAL		5 X-73 PROTECTOR CÁRTER TRASERO		1 X-74 PROTECTORES TRAPECIOS DELANTEROS		2 X-75 PROTECTORES TRAPECIOS TRASEROS		6 X-76 PROTECTOR CARDAN	
CAN AM													
	Año	Referencia	P.V.P	Referencia	P.V.P	Referencia	P.V.P	Referencia	P.V.P	Referencia	P.V.P	Referencia	P.V.P
Outlander 500	06-12	P6435	119,35	P6635	197,43	P6535	46,30	P3835	66,13	P3943	86,55	P10543	67,58
Outlander Max 500	06-12	P644	93,73	P6643	130,28	P6543	55,05	P3843	74,85	P3943	95,28	P10543	76,30
Renegade 500	08-12	P6442	109,45	P6642	146,00	P6542	70,78	P3842	90,58	P3943	111,00	P10543	67,58
Outlander 650	06-12	P6435	119,35	P6635	197,43	P6535	46,30	P3835	66,13	P3943	86,55	P10543	67,58
Outlander Max 650	06-12	P644	93,73	P6643	130,28	P6543	55,05	P3843	74,85	P3943	95,28	P10543	76,30
Outlander 800	06-12	P6435	119,35	P6635	197,43	P6535	46,30	P3835	66,13	P3943	86,55	P10543	67,58
Outlander Max 800	06-12	P644	93,73	P6643	130,28	P6543	55,05	P3843	74,85	P3943	95,28	P10543	76,30
Renegade 800	08-12	P6442	109,45	P6642	146,00	P6542	70,78	P3842	90,58	P3943	111,00	P10543	67,58
Outlander 1000 XMR	13-15	P6485	65,58	P6685	197,13	P6585	90,50	P3885	132,88	P3985	113,70		
Outlander Max 1000	13-15	P6442	109,45	P6686	200,28	P6542	70,78	P3886	136,05	P3986	116,85		
Renegade 1000	12-15	P6479	65,70	P6679	211,08	P6579	98,58	P3879	115,13	P3979	117,55	P10579	203,38
GOES													
	Año	Referencia	P.V.P	Referencia	P.V.P	Referencia	P.V.P	Referencia	P.V.P	Referencia	P.V.P	Referencia	P.V.P
520 Max	todos	P6450	88,93	P6650	116,73	P6550	97,28	P3850	110,55	P3950	96,78		
HONDA													
	Año	Referencia	P.V.P	Referencia	P.V.P	Referencia	P.V.P	Referencia	P.V.P	Referencia	P.V.P	Referencia	P.V.P
Rincon 680	06-14	P6450	90,70	P6650	154,50	P6550	75,35	P3850	66,13	P3950	140,08		
KAWASAKI													
	Año	Referencia	P.V.P	Referencia	P.V.P	Referencia	P.V.P	Referencia	P.V.P	Referencia	P.V.P	Referencia	P.V.P
KVF 650 Brute Force	05-13	P6440	112,95	P6640	121,55	P6540	46,30	P3840	71,73	P3940			
KVF 750 Brute Force	08-11	P6437	74,70	P6637	140,78	P6537	65,55	P3837	85,35	P3937	134,08		
KVF 750 Brute Force	08-11	P6452	158,08	P6652	148,45	P6552	84,78	P3852	104,58	P3952	120,45		
POLARIS													
	Año	Referencia	P.V.P	Referencia	P.V.P	Referencia	P.V.P	Referencia	P.V.P	Referencia	P.V.P	Referencia	P.V.P
Scrambler 500	05-07	P6441	85,00	P6641	141,55	P6541	110,00	P3841	66,13	P3941			
Sportsman 500 EFI	08-09	P6446	94,05	P6646	168,20	P6546	116,95	P3846	73,80	P3946	75,00		
Sportsman 700	03-07	P6438	51,55	P6638	316,55	P6538	118,88	P3838	119,15	P3938	86,15		
Sportsman 800 EFI X2	08-09	P6446	94,05	P6646	168,20	P6546	116,95	P3846	73,80	P3946	75,00		
Sportsman 800 Twin	05-13	P6438	51,55	P6638	316,55	P6538	118,88	P3838	119,15	P3938	86,15		
Sportsman 850 XP	09-13	P6460	91,05	P6660	263,30	P6560	123,23	P3860	93,05	P3960	113,08		
SUZUKI													
	Año	Referencia	P.V.P	Referencia	P.V.P	Referencia	P.V.P	Referencia	P.V.P	Referencia	P.V.P	Referencia	P.V.P
LT-A 450 King Quad	07-10	P6449	96,55	P6649	122,38	P6549	57,85	P3849	77,65	P3949	146,13		
LT-A 700 King Quad	05-07	P6449	96,55	P6649	122,38	P6549	57,85	P3849	77,65	P3949	146,13		
LT-A 750 King Quad	08-13	P6449	96,55	P6649	122,38	P6549	57,85	P3849	77,65	P3949	146,13		
LT-A 750 King Quad AXI	08-12	P6462	85,65	P6662	121,55	P6562	55,28	P3862	122,58	P3962	134,58		
YAMAHA													
	Año	Referencia	P.V.P	Referencia	P.V.P	Referencia	P.V.P	Referencia	P.V.P	Referencia	P.V.P	Referencia	P.V.P
YFM 450 Grizzly	07-13	P6472	82,28	P6672	146,93	P6572	82,28	P3872	77,65	P3972	96,15		
YFM 450 Kodiak	04-06	P6472	82,28	P6672	146,93	P6572	82,28	P3872	77,65	P3972	96,15		
YFM 660 Grizzly	02-08	P6436	88,85	P6636	125,38	P6536	87,70	P3836	69,95	P3936	93,85		
YFM 700 Grizzly	07-13	P6447	115,78	P6647	152,30	P6547	77,08	P3847	96,88	P3947	151,43		

RUEDAS Y NEUMÁTICOS

MOTOR

ADMISIÓN / ESCAPE
REFRIGERACIÓN

ELÉCTRICOS

SUSPENSIÓN / DIRECCIÓN

FRENOS

TRANSMISIÓN

CONTROLES Y MANDOS

CHASIS

ACCESORIOS

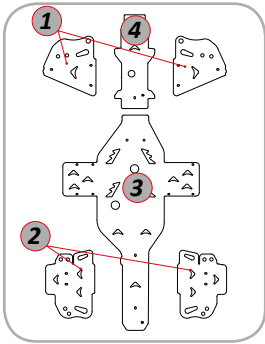

POLARIS
Sportsman 700 / 800 Twin

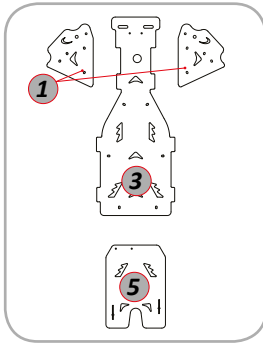

KYMCO
MXU 500

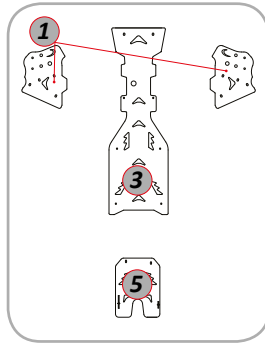

KAWASAKI
Brute Force 650

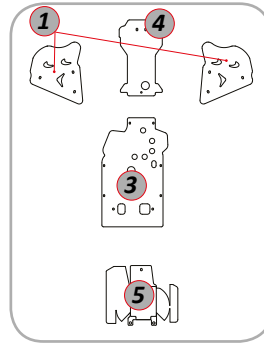

POLARIS
Scrambler 500 HO

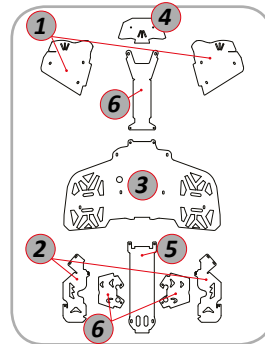

CAN AM
Renegade 500 / 800

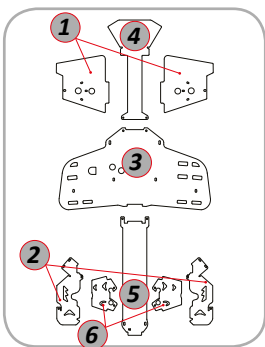

CAN AM
Outlander 500 / 650 / 800 MAX

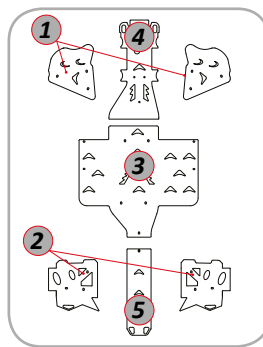

POLARIS
Sportsman 500 / 800 EFI X2

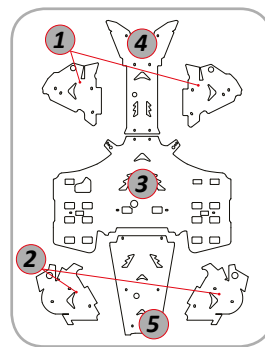

YAMAHA
Grizzly 700

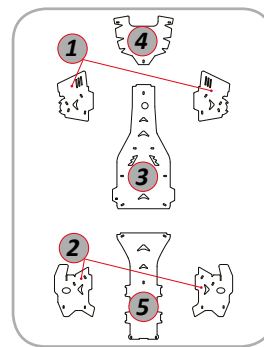

SUZUKI
King Quad 400 / 700 / 750

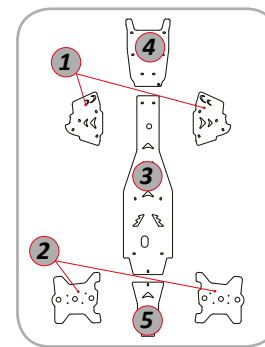

HONDA
Rincon 680

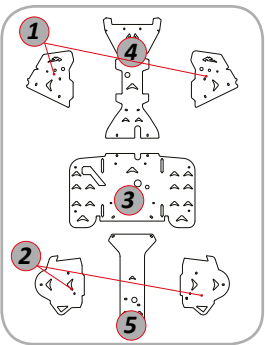

KAWASAKI
Brute Force 750 (09-12)

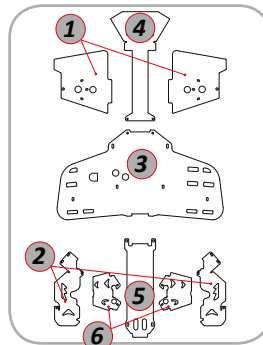

CAN AM
Outlander 500 / 650 / 800

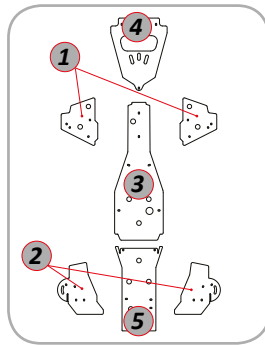

YAMAHA
Grizzly 660

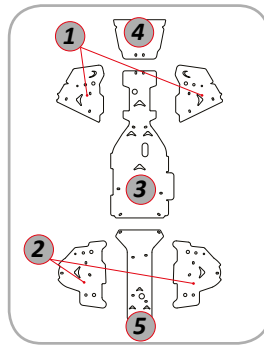

KAWASAKI
Brute Force 750 (05-08)

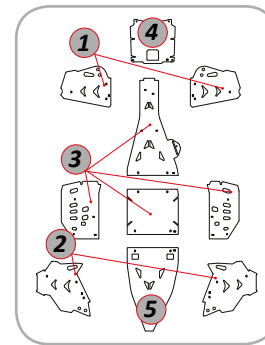

POLARIS
Sportsman 850 XP

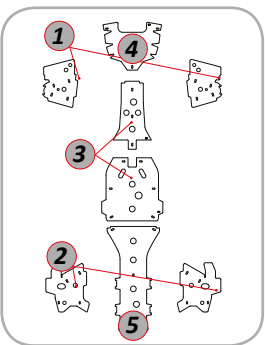

SUZUKI
King Quad 750 AXI

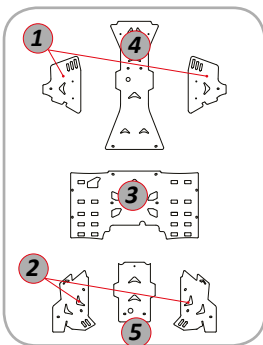

YAMAHA
Grizzly / Kodiak 450

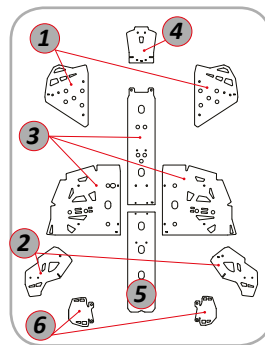

CAN AM
Renegade 1000

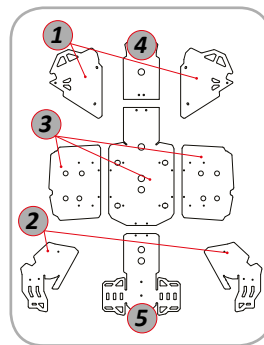

CAN AM
Outlander 1000 XMR

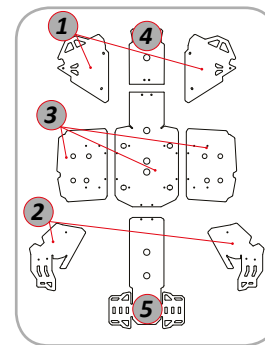

CAN AM
Outlander 1000 MAX

Maverick 1000

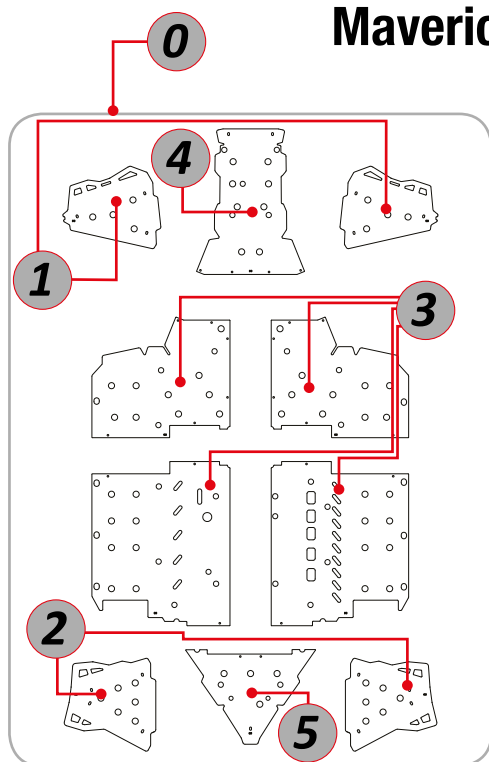

		ALUMINIO		NEGRO		
		Referencia	P.V.P.	Referencia	P.V.P.	
0	X-80	Protecciones chasis y trapecios	P5688	1026,92		
1	X-81	Protectores trapecios delanteros	P3888	139,80		
2	X-82	Protectores trapecios traseros	P3988	144,22		
3	X-91	Protector chasis central	P6688	542,05		
4	X-90	Protector chasis delantero	P6488	188,20		
5	X-92	Protector chasis trasero	P6588	102,57		
6	X-88	Puertas	P5088	733,65	P5088N	807,02
7	X-85	Defensa delantera	P6288	173,07	P6288N	190,38
8	X-86	Defensa trasera	P6388	130,77	P6388N	143,85
9	X-89	Barra protección bajos laterales	P5788	176,92		
T	X-93	Techo	P17588	56,86	P17588N	272,25
E		Separadores delanteros	P5242	56,86		
E		Separadores traseros	P5242	247,50		

Commander 800 / 1000 12-15

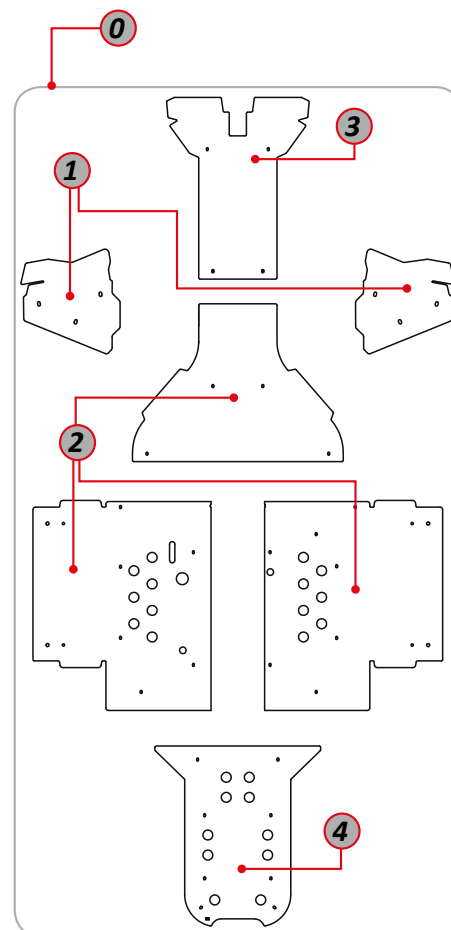

		ALUMINIO		NEGRO		
		Referencia	P.V.P.	Referencia	P.V.P.	
0	X-80	Protecciones chasis y trapecios	P5663	664,62		
1	X-81	Protectores trapecios delanteros	P3863	127,92		
2	X-91	Protector chasis central	P6663	387,45		
3	X-90	Protector chasis delantero	P6463	109,22		
4	X-92	Protector chasis trasero	P6563	134,05		
5	X-88	Puertas	P5063	617,35	P5063N	679,08
6	X-85	Defensa delantera	P6263	201,15	P6263N	221,26
7	X-89	Barra protección bajos laterales	P5763	86,92	P5763N	95,61
8		Separadores delanteros	P5242	56,86		
9		Separadores traseros	P5242	56,86		



RZR 800 08-14

	Descripción	ALUMINIO		NEGRO	
		Referencia	P.V.P.	Referencia	P.V.P.
0	X-80 Protecciones chasis y trapecios	P5645	1008,15		
1	X-81 Protectores trapecios delanteros	P3845	103,85		
2	X-82 Protectores trapecios traseros	P3945	113,00		
3	X-91 Protector chasis central	P6645	350,00		
4	X-90 Protector chasis delantero	P6445	86,92		
5	X-92 Protector chasis trasero	P6545	182,07		
6	X-88 Puertas	P5045	583,40	P5045N	641,74
7	X-85 Defensa delantera	P6245	173,07	P6245N	190,38
8	X-86 Defensa trasera	P6345	115,37	P6345N	126,91
9	X-89 Barra protección bajos laterales	P5745	211,15		

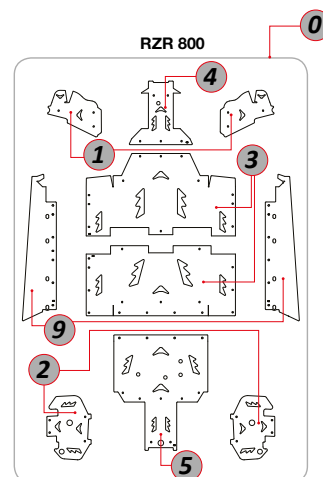

RZR 800 S 09-14

	Descripción	ALUMINIO		NEGRO	
		Referencia	P.V.P.	Referencia	P.V.P.
0	X-80 Protecciones chasis y trapecios	P5666	1008,15		
1	X-81 Protectores trapecios delanteros	P3866	103,85		
2	X-82 Protectores trapecios traseros	P3966	113,00		
3	X-91 Protector chasis central	P6645	350,00		
4	X-90 Protector chasis delantero	P6445	86,92		
5	X-92 Protector chasis trasero	P6566	182,07		
6	X-88 Puertas	P5045	583,40	P5045N	641,74
7	X-85 Defensa delantera	P6245	173,07	P6245N	190,38
8	X-86 Defensa trasera	P6345	115,37	P6345N	126,91
9	X-89 Barra protección bajos laterales	P5766	211,15		

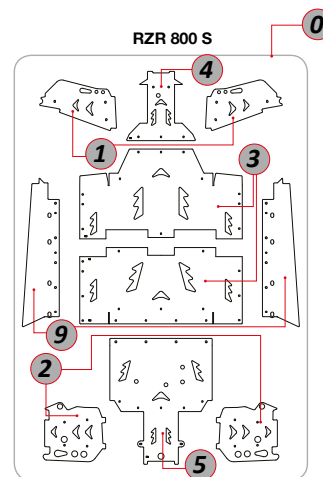

RZR 900 11-14

	Descripción	ALUMINIO		NEGRO	
		Referencia	P.V.P.	Referencia	P.V.P.
0	X-80 Protecciones chasis y trapecios	P5678	1115,37		
1	X-81 Protectores trapecios delanteros	P3878	128,92		
2	X-82 Protectores trapecios traseros	P3978	131,80		
3	X-91 Protector chasis central	P6678	444,70		
4	X-90 Protector chasis delantero	P6478	105,00		
5	X-92 Protector chasis trasero	P6578	138,07		
6	X-88 Puertas	P5078	583,39	P5078N	641,74
7	X-85 Defensa delantera	P6278	201,15	P6278N	221,26
8	X-86 Defensa trasera	P6378	161,22	P6378N	177,34
9	X-89 Barra protección bajos laterales	P5778	192,30		

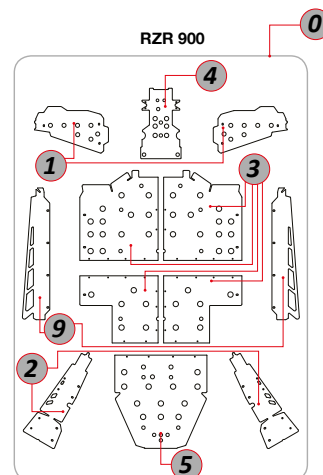

RZR 900 S 2015

	Descripción	ALUMINIO		NEGRO	
		Referencia	P.V.P.	Referencia	P.V.P.
0	X-80	P5689	973,55		
1	X-81	P3889	93,07		
2	X-82	P3989	92,80		
3	X-91	P6689	539,15		
4	X-90	P6489	76,92		
5	X-92	P6589	195,07		
7	X-85	P6287	201,15	P6278N	221,26
8	X-86	P6387	177,35	P6378N	195,08
9	X-89	P5787	66,95	P5787N	73,64
T	X-93	P17587	247,50	P17587N	272,25



RZR 1000 XP 14-16

	Descripción	ALUMINIO		NEGRO	
		Referencia	P.V.P.	Referencia	P.V.P.
0	X-80	P5687	973,55		
1	X-81	P3887	93,07		
2	X-82	P3987	92,80		
3	X-91	P6687	539,15		
4	X-90	P6487	76,92		
5	X-92	P6587	195,07		
6	X-88	P5087	733,66	P5087N	807,03
7	X-85	P6287	201,15	P6287N	221,26
8	X-86	P6387	177,35	P6387N	195,08
9	X-89	P5787	66,95	P5787N	73,64
T	X-93	P17587	247,50	P17587N	272,25

Separadores para los RZR

	Descripción	Referencia	P.V.P.
E	Separadores delanteros	P5232	56,86
E	Separadores traseros	P5232	56,86

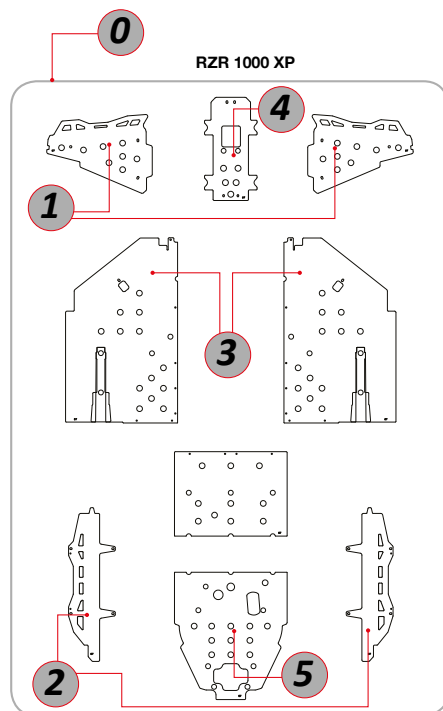
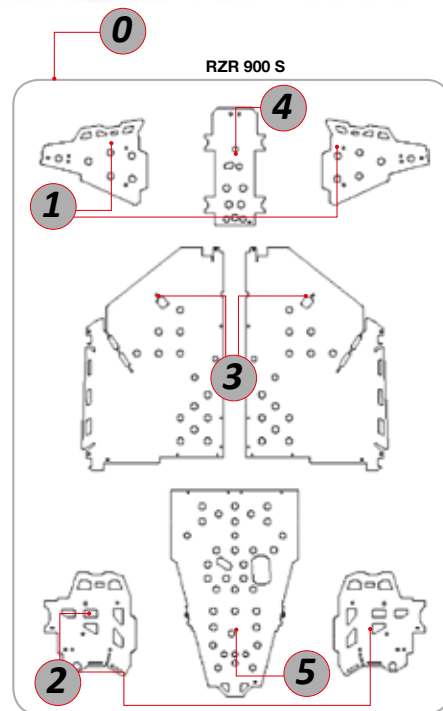

RUEDAS Y NEUMÁTICOS

MOTOR

ADMISIÓN / ESCAPE
REFRIGERACIÓN

ELÉCTRICO

SUSPENSIÓN / DIRECCIÓN

FRENOS

TRANSMISIÓN

CONTROLES Y MANDOS

CHASIS

ACCESORIOS

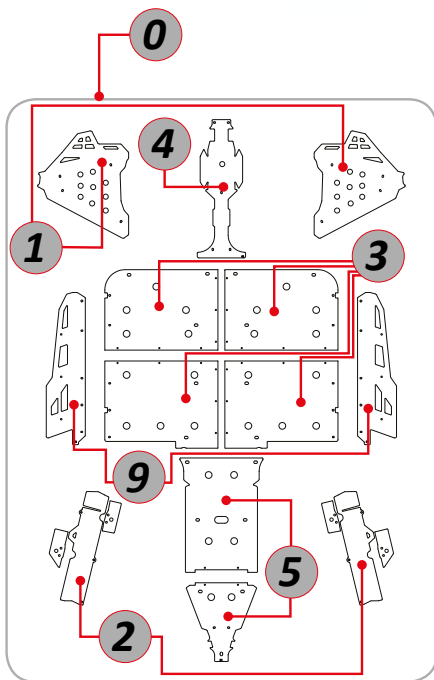

WILD CAT 1000 12-16

Descripción	ALUMINIO		NEGRO	
	Referencia	P.V.P.	Referencia	P.V.P.
0 X-80 Protecciones chasis y trapecios	P5681	1134,62		
1 X-81 Protectores trapecios delanteros	P3881	210,77		
2 X-82 Protectores trapecios traseros	P3981	170,77		
3 X-91 Protector chasis central	P6681	391,55		
4 X-90 Protector chasis delantero	P6481	117,95		
5 X-92 Protector chasis trasero	P6581	124,85		
6 X-88 Puertas	P5081	731,09	P5081N	804,20
7 X-85 Defensa delantera	P6281	201,15	P6281N	221,26
8 X-86 Defensa trasera	P6381	161,22	P6381N	177,34
9 X-89 Barra protección bajos laterales	P5781	130,65		
E Separadores delanteros	P5228	56,86		
E Separadores traseros	P5228	56,86		



ACCESORIOS Y EQUIPAMIENTO



Gafas MX / Enduro / ATV

Referencia	Modelo	Descripción	P.V.P.
DMC169771	Eco	Cross rojas	12,50
DMC169772	Eco	Cross azules	12,50
DMC169773	Eco	Cross negras	12,50
DMC16977A	Eco	Recambio lente	2,95
DMX16076BK	Racing	Cross negras	19,96
DMX16076BU	Racing	Cross azules	19,96
DMX16076RD	Racing	Cross rojas	19,96
DMX16076YL	Racing	Cross amarillas	19,96
DMX16076A	Racing	Recambio lente	6,00
DMX16076B	Racing	Paquete Tear-Off	4,00



ECO



RACING



Cascos

AP885

Casco convertible off road / integral.
 Pantalla + visor ahumado.
 Calota exterior fabricada en resina termoplástica ABS.
 Gran hueco visual.
 Sistema ventilación entrada aire en mentonera y salida en la parte posterior.
 Cierre rápido.
 Homologación: DOT / ECE



COLOR	P.V.P.	Talla XS	Talla S	Talla M	Talla L	Talla XL	Talla XXL
Blanco	112,00	A885W4	A885W5	A885W6	A885W7	A885W8	A885W9
Negro Mate	112,00	A885B4	A885B5	A885B6	A885B7	A885B8	A885B9



AP868

Calota exterior fabricada en resina termoplástica ABS.
 Gran hueco visual.
 Sistema ventilación entrada aire en mentonera y salida en la parte posterior.
 Cierre rápido.
 Homologación: DOT / ECE

COLOR	P.V.P.	Talla XS	Talla S	Talla M	Talla L	Talla XL	Talla XXL
AP-868 Blanco-Azul	78,00	A868B4	A868B5	A868B6	A868B7	A868B8	A868B9
AP-868 Blanco-Rojo	78,00	A868R4	A868R5	A868R6	A868R7	A868R8	A868R9
AP-868 Blanco-Naranja	78,00	A868O4	A868O5	A868O6	A868O7	A868O8	A868O9

AP868 Infantil

Calota exterior fabricada en resina termoplástica ABS.
 Gran hueco visual.
 Sistema ventilación entrada aire en mentonera y salida en la parte posterior.
 Cierre rápido.
 Homologación: DOT / ECE



COLOR	P.V.P.	Talla S	Talla M	Talla L
AP-868 Negro-Naranja	62,40	A868O1	A868O2	A868O3
AP-868 Negro-Plata	62,40	A868S1	A868S2	A868S3

RUEDAS Y NEUMÁTICOS

MOTOR

ADMISIÓN / ESCAPE
REFRIGERACIÓN

ELECTRICO

SUSPENSIÓN / DIRECCIÓN

FRENOS

TRANSMISIÓN

CONTROLES Y MANDOS

CHASIS

ACCESORIOS

ACCESORIOS Y EQUIPAMIENTO

Redes elásticas

Referencia	Ganxo	Dimensiones	P.V.P.
X12142	Plástico	15x15	4,00
XMC12254	Plástico	18x18	4,30
X78-60500	Hierro	15x15	4,26
X78-60510	Hierro	15x30	6,38

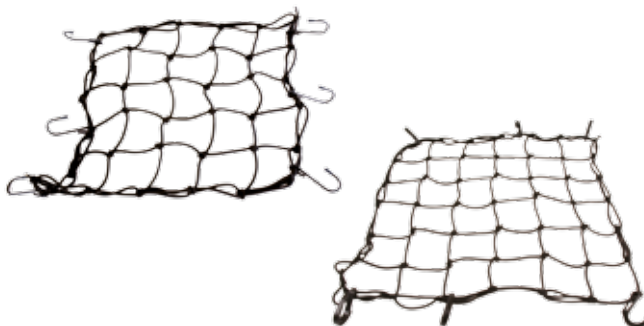

Correas

Referencia	Tipo	Descripción	P.V.P.
X4507	3	Blister 4 correas 900 kg.	16,66
X12136	3	Correa 450 kg. 1,50 m.	3,80
X12138	1	Correa 450 kg. 2,5 cm x 4,5 m.	5,40
X1213801	1	Correa 450 kg. 2,5 cm x 2,4 m.	3,60
X92716	2	Correa con carraca 450 kg. 2,5 cm x 5 m.	4,60
X78-73359	3	2 Correas 1600 kg. 2,5 cm. x 2,40 m.	8,23



Candados

Referencia	Descripción	P.V.P.
XMP12420	Candado de disco de freno	11,00
XMP12423	Candado cadena	21,40



Pulpos

Referencia	Descripción	P.V.P.
X1252504	2 pulpos de Ø 10mm x 60cm	2,60
X1252502	2 pulpos de Ø 10 mm x 90 cm	2,82



Eslinga de arrastre

Referencia	Descripción	P.V.P.
X15523	2500 kg. y 6 m.	12,80



Petate hermético

Referencia	P.V.P.
X488311	14,43



2 Luces químicas

Referencia	P.V.P.
AZUL	DSM16412B 5,00
AMARILLA	DSM16412Y 5,00



Cuchillo cutter

Referencia	P.V.P.
DSM12229	8,50



Minipala multiuso

Referencia	P.V.P.
DSM12090	13,70



Sierra plegable

Referencia	P.V.P.
DSM12151	9,20



BRONCO Maleta lona para ATV

Referencia	Largo x Ancho x Alto	P.V.P.
DAT16050	76 x 31 x 21 (30) cm	39,60
DAT16051	90 x 45 x 21 (30) cm	49,24



DAT16050



DAT16051

BRONCO Maleta rígida para ATV

Dispone de 2 cerraduras con candado (no incluidos).

Referencia	Largo x Ancho x Alto	P.V.P.
DAT12480	95 x 57 x 37 cm	219,45



DAT12480



DAT121651

BRONCO Bandeja de carga pesada ATV

Referencia	Largo x Ancho x Alto	P.V.P.
DAT121671	91 x 43 x 16 cm	94,08
DAT121661	104 x 43 x 16 cm	120,96
DAT121651	104 x 75 x 16 / 32 cm	162,34



DAT121661



DAT121651

BRONCO Parabrisas estándar para Quad y ATV

Fabricado en material plástico acrílico de 3,5mm de grosor

Referencia	Ancho x Alto	P.V.P.
DAT06469	85 x 45 cm	76,94
DAT064691	85 x 55 cm	76,23



DAT06469



DAT064691



Banderín ATV 1,80m

Referencia	P.V.P.
DSM12375	14,76

BRONCO Kit de trabajo cabrestante

Referencia	P.V.P.
DAT120751	49,83



ACCESORIOS Y EQUIPAMIENTO

BRONCO Palas de nieve

Se requiere cabrestante para subir y bajar la pala, la inclinación a derechas e izquierdas de la pala se realiza manualmente.



Hoja de 152cm de ancho por 40cm de alto y 3mm de grosor. Con refuerzos. Tenemos cuchillas de recambio.

Referencia P.V.P.

DAT124701 218,46



Soporte pala.

Referencia P.V.P.

DAT124711 208,68



Anclaje pala

ARTIC CAT	Año	Referencia	P.V.P.
400 4X4	05-11	DAT12475	
450i 4X4	10-12	DAT12475	
500 4X4	05-08	DAT12475	
550 4x4	09-12	DAT12475	
650 4X4	05-10	DAT12475	
700 4X4	06-12	DAT12475	
1000 4X4	08-12	DAT12475	
CAN AM	Año	Referencia	P.V.P.
400 Outlander	06-12	DAT12477	
500 Renegade	08-11	DAT12477	
500 Outlander	07-12	DAT12477	
650 Outlander	06-12	DAT12477	
800 Outlander	06-11	DAT12477	
800 Outlander MAX	2012	DAT12477	
800 Renegade	07-11	DAT12477	
KAWASAKI	Año	Referencia	P.V.P.
KVF 650 Brute Force	06-13	DAT12474	
KVF 750 Brute Force	05-10	DAT12474	

POLARIS	Año	Referencia	P.V.P.
330 Magnum	03-06	DAT12472	
400 Sportsman	02-05	DAT12472	
400 Sportsman HO	11-14	DAT12472	
450 Sportsman	06-07	DAT12472	
500 Sportsman HO/EFI	03-12	DAT12472	
550 Sportsman XP	09-14	DAT12472	
600 Sportsman	03-05	DAT12472	
700 Sportsman	02-08	DAT12472	
800 Sportsman	05-14	DAT12472	
850 Sportsman XP	09-14	DAT12472	
SUZUKI	Año	Referencia	P.V.P.
LT-A 450 King Quad	07-10	DAT12478	
LT-A 700 King Quad	05-07	DAT12478	
LT-A 750 X King Quad	08-13	DAT12478	
YAMAHA	Año	Referencia	P.V.P.
YFM 400 Kodiak Prof.	00-02	DAT12473	
YFM 660 GRIZZLY 4X4	02-08	DAT12473	
YFM 700 GRIZZLY 4X4	07-13	DAT12473	



La pala más versátil e innovadora específica para ATV/UTV



Quitar nieve no había sido nunca tan sencillo!!

Su diseño ligero y su manejable hoja especial para no dañar el césped, convertirá tu diversión favorita en la herramienta más valiosa.

La pala Snowsport moverá tanta nieve como tu ATV puede manipular y accederá a esos lugares difíciles de alcanzar, donde las palas tradicionales no pueden llegar.

Escoge el ancho de pala que desees y el anclaje de tu vehículo

Pala de 140 cm

Referencia	Peso (Kg.)	P.V.P.
S40054	38,50	755,92

Pala de 150 cm

Referencia	Peso (Kg.)	P.V.P.
S40060	39,50	890,32

Anclaje pala

CAN AM	Año	Referencia	Peso	P.V.P.
Outlander 500	07-09	S30520	7,85	196,34
Outlander 650	06-09	S30520	7,85	196,34
Outlander 800	05-09	S30520	7,85	196,34
Renegade 850	07-09	S30520	7,85	196,34
HONDA	Año	Referencia	Peso	P.V.P.
TRX 650 Rincon	03-06	S30560	7,85	196,34
TRX 680 Rincon	03-06	S30560	7,85	196,34
KAWASAKI	Año	Referencia	Peso	P.V.P.
KVF 650 Brute Force 4x4i	05-08	S50988	7,85	196,34
KVF 750 Brute Force 4x4i	05-08	S50988	7,85	196,34
POLARIS	Año	Referencia	Peso	P.V.P.
Sportsman 700 Twin 4x4	02-06	S30500	7,85	196,34
Sportsman 800 Twin 4x4	02-06	S30500	7,85	196,34
Ranger	05-06	S40480	7,85	196,34
RZR	08-09	S60044	7,85	196,34
SUZUKI	Año	Referencia	Peso	P.V.P.
LTA 450 King Quad	07-08	S30530	7,85	196,34
LTA 700 King Quad	05-07	S30530	7,85	196,34
LTA 750 King Quad	08-10	S30530	7,85	196,34
YAMAHA	Año	Referencia	Peso	P.V.P.
YFM 660 Grizzly	02-06	S30540	7,85	196,34
YFM 700 Grizzly	07-10	S60230	7,85	196,34
YXR 660 Rhino	04-07	S60077	7,85	94,50
YXR 700 Rhino	08-10	S60077	7,85	94,50

Funcionamiento

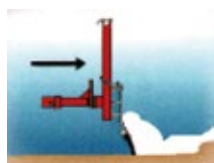

1 Simplemente conduce hacia delante.

Recuerda, con la pala Snowsport no tendrás que utilizar mandos.



2 Deja a la hoja hacer el trabajo.

Seguirá el terreno mientras tú conduces. Esta hoja se ha diseñado especialmente para empujar la nieve amontonándola hacia arriba para maximizar su capacidad.



3 Filo de corte sensible en temperatura.

Se hace más rígido en temporada de frío para cortar a través de la nieve, pero permanece flexible en temporada de calor, por lo que nos proporciona una doble función.

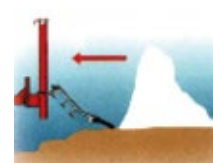

4 Cuando estés preparado para la marcha atrás, simplemente ve hacia atrás.

La hoja sigue activa en movimiento, dejando la nieve en una pila y a ti libre para continuar la conducción.

TALLER

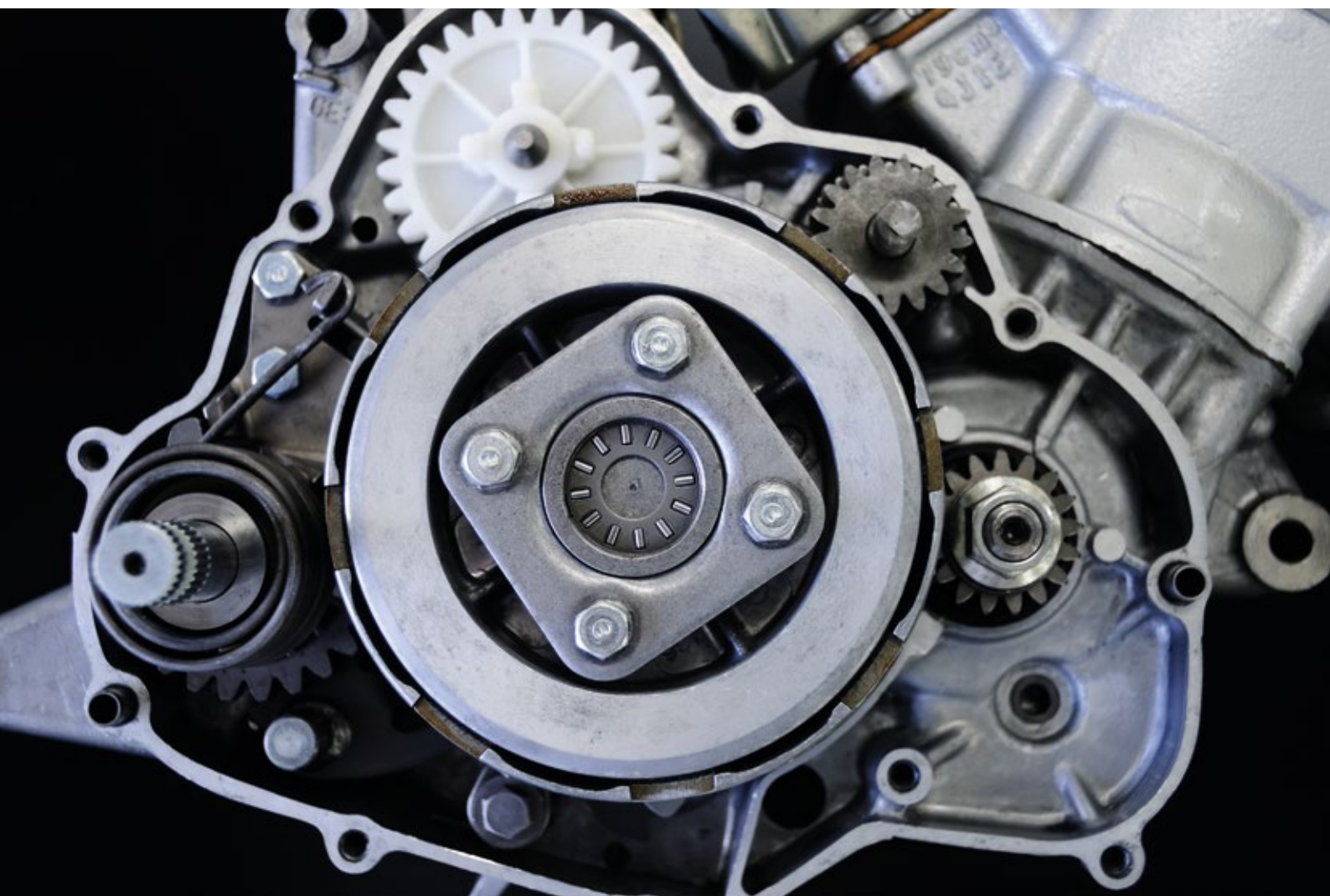

Cinta aislante

Referencia	Descripción	P.V.P.
T00100	Paquete de 10 cintas. Negro 25m. x 19 mm.	18,92
T00200	Paquete de 10 cintas. Blanca 25m. x 19 mm.	17,82



Brida poliamida

Referencia	Descripción	P.V.P.
T20026N	Paquete 100 unidades brida negra 200x2,5 mm.	1,89
T28048N	Paquete 100 unidades brida negra 270x4,8 mm.	4,38
T36048N	Paquete 100 unidades brida negra 385x4,6 mm.	6,15
T36578N	Paquete 100 unidades brida negra 385x7,6 mm.	14,70

Funda retráctil

En paquetes de 20 tiras de 25 cm.

Referencia	Descripción	P.V.P.
T0024N	Retráctil Poliolefina Negro de diámetro 2,4 mm.	9,28
T0048N	Retráctil Poliolefina Negro de diámetro 4,8 mm.	10,40
T0064N	Retráctil Poliolefina Negro de diámetro 6,4 mm.	11,20
T0127N	Retráctil Poliolefina Negro de diámetro 12,7 mm.	14,56
T0191N	Retráctil Poliolefina Negro de diámetro 19,1 mm.	18,56



Faston latón

Referencia	Descripción	P.V.P.
T14648	Fastón hembra. Ancho 6.3 mm. Grosor 0.8 mm. Corto.	23,30
T16422	Fastón macho. Ancho 6.3 mm. Grosor 0.8 mm. Corto.	37,57
T14327	Fastón hembra. Ancho 6.3 mm. Grosor 0.8 mm. Retén.	30,50
T16432	Fastón macho. Ancho 6.3 mm. Grosor 0.8 mm. Retén.	41,52

Regleta poliamida

Referencia	Descripción	P.V.P.
T74004	Paquete 10 tiras homologado de 4 mm.	10,10
T74006	Paquete 10 tiras homologado de 6 mm.	15,50
T844006	1 Tira para conexión de Faston 6.3 mm	2,15

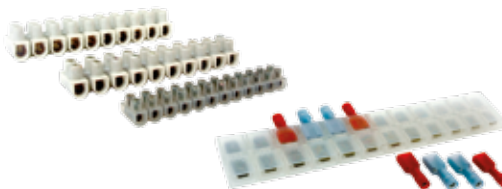

Kit terminales

Referencia	Descripción	P.V.P.
X01653	Caja Terminales	23,06
X81498	Caja Terminales con Herramienta	11,00

Fusibles redondos



P.V.P
12,95

100 FUSIBLES

P.V.P
1,50

5 FUSIBLES

Amperios	100 FUSIBLES		5 FUSIBLES	
	LARGO 25MM	LARGO 30MM	LARGO 25MM	LARGO 30MM
Referencia	Referencia	Referencia	Referencia	Referencia
5	-	E48-05011	-	E48-05011A
7.5	E48-04911	-	E48-04911A	-
10	E48-04912	E48-05013	E48-04912A	E48-05013A
15	E48-04913	E48-05014	E48-04913A	E48-05014A
20	E48-04914	E48-05015	E48-04914A	E48-05015A
25	E48-04915	E48-05016	E48-04915A	E48-05016A
30	E48-04916	E48-05017	E48-04916A	E48-05017A

Portafusibles



Referencia	Descripción	P.V.P.
E48-93320	Para fusibles de 30 mm	1,02

Fusibles pastilla



P.V.P
14,95

100 FUSIBLES

P.V.P
2,00

10 FUSIBLES

Amperios	100 FUSIBLES		10 FUSIBLES	
	MINIFUSIBLES	NORMAL	MINIFUSIBLES	NORMAL
Referencia	Referencia	Referencia	Referencia	Referencia
5	E48-05060	-	E48-05060A	-
7.5	E48-05061	-	E48-05061A	-
10	E48-05062	E48-05052	E48-05062A	E48-05052A
15	E48-05063	E48-05053	E48-05063A	E48-05053A
20	E48-05064	E48-05054	E48-05064A	E48-05054A
25	E48-05065	E48-05055	E48-05065A	E48-05055A
30	E48-05066	E48-05056	E48-05066A	E48-05056A

Portafusibles impermeable



Referencia	Descripción	P.V.P.
E48-93321	Para tamaño normal	1,74



D04900



D04920

Juego de fusibles

Las cajas contienen 300 o 360 fusibles variados.

Referencia	Descripción	P.V.P.
D04900	150 Fusibles redondos de 30mm de 5 / 10 / 15 / 20 / 25 / 30 150 Fusibles redondos de 25mm de 7,5 / 10 / 15 / 20 / 25 / 30	57,95
D04920	60 Fusibles redondos de 25mm de 7,5 / 10 / 15 / 20 / 25 / 30 60 Fusibles redondos de 30mm de 5 / 10 / 15 / 20 / 25 / 30 210 Mini fusibles de pastilla de 5 / 7,5 / 10 / 15 / 20 / 25 / 30 150 Fusibles de pastilla de 10 / 15 / 20 / 25 / 30	57,95

Bombillas

Se sirve en cajas de 10 unidades.



Figura	Referencia	Descripción	P.V.P.	Aplicación
A	E48-66606	6V 18/4W	3,50	Bombillas de posición y freno
	E48-66612	12V 25/4W	3,50	
B	E48-66806	6V 18W	3,50	Bombillas para intermitente y freno
	E48-66812	12V 25W	3,50	
C	E48-66406	6V 3W	2,50	Bombillas de posición para freno
	E48-66412	12V 3W	2,50	
D	E48-66512	12V 18W	5,50	
	E48-66513	12V 21/6W	5,50	
E	E48-66712	12V 10W	3,50	Bombillas para intermitente
	E48-66723	12V 10W	3,50	
E	E48-66713	12V 23W	3,50	Bombillas para intermitente
	E48-66724	12V 23W	3,50	
F	E48-65812	12V 45/45W	6,20	Bombillas para luces cortas y largas
G	E48-66912	12V 48/48W		Bombillas para luces cortas y largas
	E48-66922	12V 48/48W		
H	E48-66932	12V 35/35W		Bombillas para luces cortas y largas
I	*DAT01060L	12V 30/30W	4,00	Bombillas Yamaha cortas y largas
	*DAT010601L	12V 35/35W	4,00	
	*E48-67730	12V 55W	1,04	

* Se sirve en cajas de 1 unidad.

Cable auxiliar batería

Referencia	P.V.P.
E84-96308	8,55

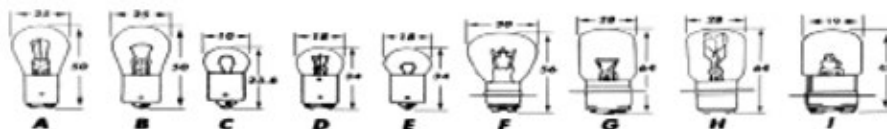

Comprobador de corriente

Referencia	P.V.P.
DIN12088	5,98

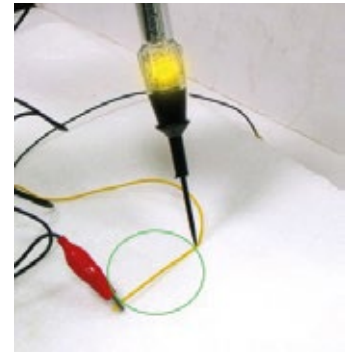

Extractor de muelles

Referencia	P.V.P.
DUP12351	6,98



Gafas de seguridad

Referencia	Descripción	P.V.P.
X03000	Transparente	9,90
X03010	Trabajos exteriores	9,90
X03030	Solar	9,90



Caja tornillos

Referencia	P.V.P.
DIN12700	5,91



Neumática para fuelle

Referencia	P.V.P.
U660005T	252,00



Cierra bridas fuelles

Referencia	P.V.P.
DMC12758	22,37



Tensor bridas fuelles

Referencia	P.V.P.
DUP12077	15,44



Alicates de cortar

Referencia	P.V.P.
D52040	20,00

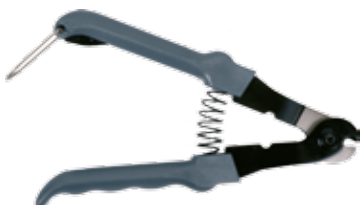

Juego de Allen T

Referencia	P.V.P.
D130030	16,23



Juego de Allen

Referencia	P.V.P.
D108185	9,30



Plato magnético

Referencia	P.V.P.
DMC12202	6,50



Llave T

	Referencia	P.V.P.
12 mm	E84-03862	4,48
14mm	E84-03863	4,48



Clasificadores

Referencia	Descripción	P.V.P.
DIN127071	18 particiones	5,49
DUP12157	48 particiones	4,95



Destorgolpe

Referencia	P.V.P.
E84-03800	14,64



Recambio de puntas

	Referencia	P.V.P.
CORTAS	E84-03801	1,95
LARGAS	E84-03802	3,28



Mini llave tubo octogonal

Referencia	Medidas (mm)	P.V.P.
DMP120342	8 / 9 / 10	4,20
DMP12034	12 / 13 / 14	4,20



Alicates para segers

Referencia	P.V.P.
E84-03811	9,60



Carraca

Referencia	P.V.P.
DMC12353	8,50



Provetas medidoras líquido

Referencia	Descripción	P.V.P.
DUP12015	500 ml	3,65
DUP120151	250 ml	3,65



Afloja amortiguadores

Referencia	P.V.P.
E84-66310	11,56
DSM08040	4,80



Bloqueador de frenos

Referencia	P.V.P.
DUP12430	6,33



Depósito gasolina portátil 0,5l.

Referencia	P.V.P.
DUP12185	24,81



Aflojafiltros

Referencia	Dimensión	P.V.P. (€)
DMC1236318	65 mm	5,12
E84-04182	67 mm	5,12



Aflojafiltros

Referencia	Dimensión	P.V.P.
DUP12073	60-76 mm	12,63
DUP120731	73-85 mm	12,63



Aflojafiltros

Referencia	Dimensión	P.V.P.
DMC12730A	70-125 mm	11,73



Extractor de chiclés

Referencia	P.V.P.
DUP12069	9,63



Limpiador de chiclés

Referencia	P.V.P.
DMP12327	5,93



Galgas Chiclés

Referencia	Medidas (mm)	P.V.P.
DUP12171	Desde 0,45 - 1,5	10,80
DUP121711	Desde 1,5 a 3,0	10,80



Alicates trenzadoras y alambre inoxidable

Referencia	Descripción	P.V.P.
E84-03816	Alicates	33,90
DUP12851	Alambre inoxidable	6,30



Portachiclés

	Referencia	P.V.P.
1	XSM07067	4,50
2	XSM07022	7,00
3	X0718704	4,70



Destornillador curvo

Referencia	P.V.P.
DUP12840	85,82



Lubricador de cables

	Referencia	P.V.P.
AZUL	E84-81190	6,32
NEGRO	D7100	4,99

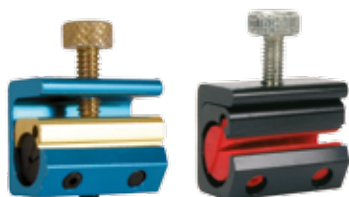

Minicortacadenas

Referencia	P.V.P.
D108001	23,16



Destalonador de neumáticos

Referencia	P.V.P.
DMX12041	15,34



Equilibrador de ruedas

Referencia	P.V.P.
DMC12452	125,16

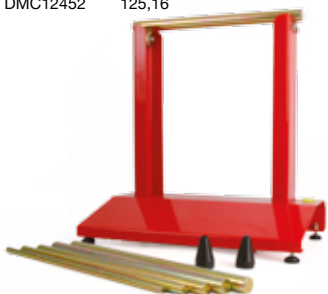

Talonador de neumáticos

Referencia	P.V.P.
DUP12051	4,84



Centrador de cámara

Referencia	P.V.P.
DUP12037	7,65

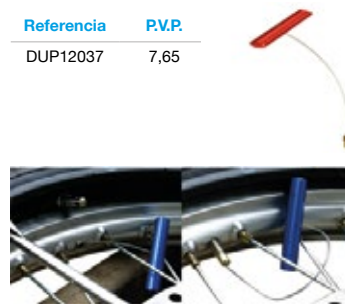

Palanca neumáticos

Referencia	Descripción	P.V.P.
D130020	largo 40cm	9,10
D130023	largo 38cm	10,32
DMX12100	largo 26cm	10,28

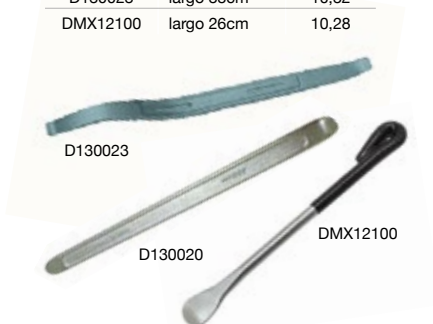

Reparador válvula llanta

Referencia	Descripción	P.V.P.
DUP12064	Tipo A	3,80
DUP12046	Tipo B	6,12



Montador de válvulas aire

Referencia	P.V.P.
DUP12058	9,48



Llave para radios

Referencia	P.V.P.
D130022	7,28



Extractor de retenes

Referencia	P.V.P.
DUP121791	14,98



Extractor de muelles

Referencia	P.V.P.
DUP12089	23,00



Tornillos y tuercas seguridad

Referencia	P.V.P.
DUP12072	28,76



Extractor rótulas

Referencia	P.V.P.
DAT12286	13,44



Conector rápido gasolina

Referencia	Descripción	P.V.P.
DAT07040	Tubo Ø6mm	8,23
DAT070401	Tubo Ø8mm	9,17



Compresor aros-pistón

Referencia	P.V.P.
DUP12071	14,49



Compresor aros-pistón

Referencia	Diámetro	P.V.P.
DSM120561	53 a 125	9,40
DSM12056	40 a 80	8,90



Útil para colocar aros

Referencia	P.V.P.
DSM12022	7,68



Extractor de bulón

Referencia	P.V.P.
X09610	16,68



Compresor de válvulas

Referencia	P.V.P.
DMP123261	35,10



Montador de válvulas

Referencia	Descripción	P.V.P.
DMX12971	Válvula 5mm	13,14
DMX129711	Válvula 5,5mm	13,14



Extractor espárragos cilindro

Referencia	P.V.P.
DUP12053	10,80



M6 x 1,0 M8 x 1,25 M10 x 1,25

Extractor de rodamientos

Referencia	P.V.P.
DMC12729	130,28



- 8-10 mm
- 10-12 mm
- 12-14 mm
- 15-17 mm
- 17-20 mm
- 20-24 mm
- 25-29 mm
- 30-32 mm

Alicates plato embrague

Referencia	P.V.P.
DUP12212	17,95



Llave de reglaje

Conjunto de tres llaves de 8 / 9 / 10 mm
Y ajustes de 3 / 4 mm

Referencia	P.V.P.
DUP12050	38,46



Extractores de plato magnético

Referencia	Medida (mm)	Descripción	P.V.P.
DAT12150	M50 x P1,5 derecha	Suzuki LT-A 400 / 450 / 500 / 700 / 750	54,29
DAT12664	M38 x P1,5 derecha	CAN AM DS 650	27,58
DAT12926	M35 x P1,5 derecha	Yamaha YFM 350 / YFM 400 / YFM 450 / YFM 550 / YFM 660 / YFM 700 (para todos los modelos)	16,92
DMX12280	M27 x P1,0 izquierda	Honda CR 80R / 125 R / 250 R / 450 R / 480 R / 500 R, XL 80 / 100 / 170, XR 50 / 100, CRF 50 00-04 Kawasaki KX 80, KD 80, KDX 80, KM 100 KTM SX 65 99-04, SX 85 04, SX 105 04 / 125 / 250 / 300 / 380 98-05 EXC 200 98-05 / 125 / 250 / 300 / 380 98-05 MXC 200 98-05 / 125 / 250 / 300 / 380 98-05	9,93
DMX12285	M30 x P1,0	Yamaha WR 250 03-06	13,53
DMX12925	M38 x P1,5 derecha	Suzuki LTZ 400, DRZ 400 Kawasaki KLX 400, KFX 400	29,49
DMX12926	M28 x P1,0 derecha	Honda TRX 450 R 04-05 / CR 250 R 78-80 Kawasaki KLX 110 03-07 Suzuki DR - Z 110 03-05	16,97
DMX12927	M27 x P1,25 izquierda	Husqvarna 60-70 2t / KTM 2t / Buftaco / Ossa / Montesa / Maico	9,93
DMX12928	M26 x P1,5 derecha	Husqvarna y Cagiva a partir del 1971	9,93
DMX12929	M26 x P1,5 / M27 x P1,25	KTM / Montesa	9,93
DMX12930	M19 x P1,5 / M22 x P1,5		9,93
DMX12932	M28 x P1,0	Honda CRF 450 X 04-08 / TRX 450 R 06-08 Kawasaki KLX 450 R 08 Susuki RMZ 450	13,68
DMX12951	M24 x P1,5 derecha	Honda CRF 450 02-06, CRF 250 R/X 03-06 / CRF 150 R 07 Kawasaki KX 250 F 04-05, KX 450 F 06 Suzuki RMZ 250 04-06, RMZ 450 05-06 Yamaha YZF 450 06-07	17,15
DMX12952	M26 x P1,0 derecha	KTM 250 SX-F, 400, 450, 520, 525	16,66
DUP12295	M19 x P1,5 derecha M22 x P1,5 derecha	KTM / Montesa	9,93
DUP12920	M19 x P1,0 derecha M22 x P1,5 derecha		9,93



DMX12280



DMX12285



DMX12925



DMX12926



DMX12927



DMX12928



DMX12929



DMX12930



DAT12926



DMX12932



DMX12951



DMX12952



DAT12150



DAT12664



DUP12295



DUP12920

Referencia	P.V.P.
DMP12331	57,80



M14 x P 1,5
 M16 x P 1,5
 M18 x P 1,5
 M19 x P 1,0
 M20 x P 1,0
 M22 x P 1,0
 M22 x P 1,5
 M24 x P 1,0
 M25 x P 1,5
 M26 x P 1,0
 M26 x P 1,5
 M27 x P 1,0
 M27 x P 1,5
 M28 x P 1,0
 M28 x P 1,5

Referencia	P.V.P.
DUP12056	25,06



Utillajes específicos KTM

Bloqueador de pistón

Referencia	P.V.P.
DMX12152	8,32



Útil suspensión delantera

Referencia	P.V.P.
DMX12151	11,60



Ajustador válvula escape 2t

Referencia	P.V.P.
DMX12153	9,80



Útil zapatas embrague

Referencia	P.V.P.
DMX12154	9,00



Rascador de juntas

Referencia	P.V.P.
DUP12290	6,84



Llave bujía

Referencia	P.V.P.
D130021	6,53



Juego de embudos

Referencia	P.V.P.
DUC12201	4,80



Control

Referencia	P.V.P.
DMC12682	6,89



2 Bolas depósito gasolina de nilón

Referencia	P.V.P.
DUP12017	1,99



ASonic Limpiadores Ultrasónicos



PRO 60



PRO 960

La limpieza por Ultrasonidos se base en el proceso de cavitación, es decir, la formación de burbujas microscópicas en el líquido a través de los que pasa el ultrasonido. Estas burbujas se mueven en el líquido y cuando llegan a la superficie del objeto explotan y la energía que crean eliminan las impurezas de la superficie. A causa de su pequeño tamaño las burbujas penetran en agujeros, poros, perforaciones, roturas, etc. de las que elimina las impurezas como el polvo, aceites, óxido, grasas, hongos, bacterias, cal, hollín, ceras, etc. en el depósito. Para la limpieza usted debe utilizar el líquido requerido para cada uso mezclado con agua destilada. Los materiales adecuados para ser limpiados son metálicos, plásticos, cristales, cerámicos y de caucho.

La utilización del ASONIC es segura y fácil a través de los controles digitales.

Coloque el ASONIC sobre una superficie dura. Antes de encender el limpiador ultrasónico, debe llenar el depósito con la solución rebajada con agua destilada, colocar los objetos a limpiar en el cesto y sumergirlo en el depósito. La limpieza es más efectiva si las piezas se encuentran en el centro del cesto. Si el agua se derramase sobre la carcasa ha de secarse antes de la conexión del ASONIC, para evitar la posibilidad de un cortocircuito. Una vez el dispositivo esté

conectado a la red eléctrica, debe ser activado con el interruptor ON/OFF situado en la parte posterior. Si se requiere calentar el líquido del depósito, fijar la temperatura con las teclas (+) y (-) de la izquierda y activar el calentador con el botón "CALEFACCION ON/OFF". La pantalla superior mostrará la temperatura programada en principio y más tarde la temperatura actual del depósito. Cuando el líquido alcance la temperatura deseada usted podrá ajustar el temporizador de ultrasonidos con las teclas (+) y (-) del lado derecho al valor deseado y activar las ondas ultrasónicas con la tecla "ULTRASONIDOS ON/OFF". La pantalla del lado derecho se utiliza para controlar el tiempo restante. Cuando termine la limpieza, esperar a que el líquido del depósito se enfríe hasta un nivel de seguridad antes de retirar la cesta.



Líquidos de limpieza

Cada problema dispone de su solución específica. Los líquidos son concentrados y tienen que ir diluidos entre un 5% y un 10% en agua destilada según requiera la limpieza (**ES IMPORTANTE USAR AGUA DESTILADA** porque sino se pueden calcificar las piezas, la cubeta, la cesta, etc.).

- **Fuerte:** Solución extra fuerte, solo para plásticos, goma, cerámica y cristal.
- **Carburador:** Recomendada para todo tipo de carburadores e inyectores.
- **Óxido:** Para todo tipo de metales que se quiera eliminar el óxido.
- **Materiales sensibles:** Aluminio, latón, estaño, etc.
- **PCB:** Placas y componentes eléctricos / electrónicos.

Referencia	Descripción	P.V.P.
PASGEN1	Fuerte 1l.	13,30
PASGEN25	Fuerte 25l.	170,00
PASCARB1	Carburador 1l.	13,30
PASCARB5	Carburador 5l.	55,00
PASCARB25	Carburador 25l.	170,00
PASOXI1	Óxido 1l.	13,30
PASOXI5	Óxido 5l.	55,00
PASSENS1	Materiales sensibles 1l.	13,30
PASSENS5	Materiales sensibles 5l.	55,00
PASPCB1	PCB 1l.	13,30
PASPCB5	PCB 5l.	55,00

PRO 200



ASonic Limpiadores ultrasónicos PRO

Los limpiadores ultrasónicos en series ASonic PRO son la mejor opción para usuarios profesionales que requieren una limpieza total, solo posible separando el ajuste del temporizador del ultrasonido y temperatura del calentador. Los transductores ultrasónicos de los limpiadores ASonic PRO trabajan en una frecuencia de 40 KHZ. Los controles digitales se utilizan para ajustar el temporizador de 1 a 99 minutos, y la temperatura del depósito hasta 80°C. Los depósitos de estos limpiadores ultrasónicos están hechos de una sola pieza de acero inoxidable (SUS304). Cada limpiador ultrasónico viene con su apropiada tapa, cesto de limpieza y cable.

Modelo / Ref.	PRO 20	PRO 30	PRO 60	PRO 90	PRO 130	PRO 200	PRO 270
Potencia ultrasónica	50 W	100 W	150 W	200 W	300 W	400 W	500 W
Potencia de calor	100 W	100 W	300 W	300 W	400 W	500 W	500 W
Volumen del depósito	1,85 l	2,9 l	6,15 l	9,0 l	13,0 l	20,0 l	27,0 l
Dimensiones del cesto (mm)	130x110x75	210x115x72	265x135x110	277x220x115	310x280x110	460x270x100	460x270x120
Dimensiones del depósito (mm)	150x140x100	240x140x100	300x155x150	300x240x150	355x325x150	530x325x150x	530x325x200
Dimensiones de la unidad (mm)	190x170x220	270x170x240	330x180x310	330x270x310	360x330x310	550x330x310	550x330x360
Válvula de descarga	NO	NO	SI	SI	SI	SI	SI
Peso	2,8 kg	3,8 kg	7,0 kg	8,5 kg	11,8 kg	14,5 kg	16,5 kg
P.V.P.	138,99	218,99	259,99	419,99	538,99	673,99	799,99

ASonic Limpiadores ultrasónicos de gran capacidad PRO

Los limpiadores ultrasónicos de gran capacidad ASonic PRO están destinados a usuarios avanzados y profesionales que necesitan limpieza de larga duración de objetos más grandes a alta temperatura. Los transductores ultrasónicos de los limpiadores ASonic PRO trabajan en una frecuencia de 28 kHz, y su potencia se puede ajustar por controles digitales en la gama de 0-100% de los valores específicos, excepto para el modelo PRO 360, que tiene comandos analógicos y la potencia del ultrasonido no es ajustable. Estos limpiadores se suministran con calentadores que permiten calentar el líquido del depósito hasta 110°C. Los limpiadores ultrasónicos de gran capacidad ASonic PRO son capaces de funcionar 24 horas ininterrumpidamente y tienen depósitos especiales de consistente acero inoxidable resistente a ácidos y corrosión. Cada limpiador ultrasónico viene con su apropiada tapa, cesto de limpieza y cable.

PRO 360



Modelo / Ref.	PRO 360	PRO 650	PRO 960	PRO 1570	PRO 2060
Potencia ultrasónica	720 W	1080 W	1440 W	2160 W	2520 W
Potencia de calor	500 W	3000 W	4000 W	5000 W	6000 W
Volumen del depósito	36,0 l	65,0 l	96,0 l	157,0 l	206,0 l
Dimensiones del depósito (mm)	510x300x250	500x350x360	600x400x400	700x500x450	750x550x450
Dimensiones de la unidad (mm)	550x330x360	630x480x650	730x530x700	840x640x750	890x690x800
Válvula de descarga	SI	SI	SI	SI	SI
Peso	30,0 kg	53,0 kg	70,0 kg	75,0 kg	99,0 kg
P.V.P.	1.409,99€	2529,99€	3259,99€	4225,99€	4695,99€



Introducción a los combustibles

Lo que necesita saber sobre cómo mantener la calidad del combustible

Problema 1: Estabilidad del combustible y presencia de residuos

La solución Star Tron®: Star Tron® es un potente estabilizador de combustible que ayuda a prevenir la descomposición del combustible hasta los dos años. De esta forma se consigue un arranque más fácil y más potencia, a la vez que se evita el picado de las bielas. Star Tron® mejora el nivel de octano de combustibles antiguos, de baja calidad o sin especificación. En muchos casos, Star Tron puede renovar el combustible estancado y restaurarlo para volver a utilizarlo. Las enzimas de Star Tron® descomponen la goma y otros residuos en partículas de un tamaño inferior a la micra. Esto permite que se dispersen por el combustible y que se “quemen” fácilmente durante el proceso de combustión, con lo que se consigue recuperar el rendimiento total del combustible y su eficiencia.



Problema 2: Agua en el combustible

La solución Star Tron®: La fórmula enzimática de Star Tron® trata el agua minimizando la tensión superficial entre el combustible y el agua y reduce el tamaño de las gotas de agua a moléculas. Esto permite una mayor propagación del agua por el combustible ya que las gotas de agua, de un tamaño inferior a la micra, se eliminan de forma segura durante el funcionamiento del motor. Al tratar el combustible con Star Tron®, se quema más agua que en el caso de los combustibles que no han recibido tratamiento, por lo que también se consigue secar el depósito y evitar la acumulación de agua.

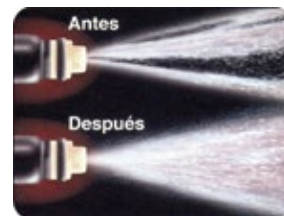

Problema 3: Disminución de la potencia y del rendimiento

La fórmula enzimática de Star Tron® permite romper los grandes racimos de moléculas de combustible para crear una mayor superficie. Esto permite que una mayor proporción de oxígeno reaccione durante la combustión, lo que se traduce en una combustión más completa del combustible, en un aumento de la eficiencia del combustible y de la potencia de motor, en una mejor respuesta de aceleración y en **menos emisiones tóxicas**. Star Tron® elimina los depósitos de carbón y mantiene su motor limpio y a pleno rendimiento.



¿Qué es Star Tron?

Star Tron® lleva solucionando problemas de combustible en motores de EE. UU. desde 2003. Mejora el rendimiento de todas las embarcaciones, coches, camiones, motocicletas, motos de nieve, todoterrenos, motores de agua, generadores, cortacéspedes y equipos de jardín. Star Tron® se puede usar de forma segura en cualquier motor de gasolina y en cualquier entorno, ofrece uno de los costes por litro más bajos en comparación con el resto de aditivos de combustible.

Star Tron® es fácil de utilizar, es eficaz y no presenta ningún peligro en el caso de dosis excesivas.

INSTRUCCIONES:

DOSIS INICIAL: Añadir 10 ml por cada RECARGA de 10 l de gasolina: Añadir 5 ml por cada 10 l de gasolina

Si desea conocer la historia de Star Tron® visite startron.com



Referencia	Descripción	P.V.P.
S14516	30 ml. para 90 litros de gasolina	7,40
S14516E	30 ml. para 90 litros de gasolina (16 und.)	118,40

Referencia	Descripción	P.V.P.
S14616	250 ml. para 180 litros de gasolina	12,36
S14616E	250 ml. para 180 litros de gasolina (6 und.)	74,88



XPEED Grasas



Chain Lube

Spray cadena resistente al agua

Referencia: S15135
P.V.P. 7,35€

Grasa hidrófuga formulada a base de aditivos especiales que confieren a la grasa grandes prestaciones de untuosidad, adherencia y poder sellante. Alta protección anticorrosiva. Insoluble al agua.

Lubricación de cadenas, rodamientos, cojinetes y todo tipo de elementos sometidos a la acción directa de agua y vapor con altas cargas dinámicas.



Chain Lube Racing

Spray cadena Long Life PTFE

Referencia: S15837
P.V.P. 12,60€

Grasa sintética blanca formulada a base de PTFE y aditivos especiales que confieren a la grasa grandes prestaciones en las condiciones de uso más severas. Excelente adherencia y estanqueidad. Insoluble al agua. No gotea. Alta protección anticorrosiva y antidesgaste.

Especialmente desarrollada para cadenas de transmisión con retenes de altas prestaciones. Para Motocicletas de gran cilindrada, Quads, Karts altamente revolucionados, etc.



Spray abrillantador silicona

Plásticos y Cauchos

Referencia: S35155
P.V.P. 5,25€

Producto multifuncional a base de emulsiones de siliconas que le confieren unas cualidades únicas para prevenir, proteger regenerar y abrillantar plásticos, cauchos, vinilos, etc.



Grasa complejo litio EP

Rótulas y Rodamientos

Referencia: S15350
P.V.P. 6,90€

Grasa multifuncional complejo de litio de alto rendimiento. Contiene aditivos extrema presión, anticorrosivos, anti-herrumbre y antioxidante. No gotea. Reduce la fricción y el desgaste. Temperatura de aplicación de -20° C a 150° C.

Lubricación de larga duración de todo tipo de mecanismos, rodamientos, cojinetes lisos, articulaciones, guías, ejes, husillos, etc., sometidos a cargas altas y velocidades medias altas.



Grasa litio EP

Rótulas y Rodamientos

Referencia: S15351
P.V.P. 5,98€

Cartucho de grasa multifuncional en base aceite mineral de alto grado y jabón de litio. Contiene aditivos extrema presión y aditivos necesarios que le confieren una buena protección anticorrosiva, anti-herrumbre y antioxidante.



Grasa ptf alto rendimiento

Rótulas y Rodamientos

Referencia: S15312
P.V.P. 12,95€

Cartucho de grasa multifuncional Extrema Presión con micropartículas de PTFE que incorpora aditivos de nueva generación. Excelente resistencia a cargas y altas temperaturas. Gran resistencia al agua. Alarga los periodos de lubricación. Gran adherencia. Reduce la fricción y el desgaste.





Aceite mezcla para motores 2 tiempos

RACING 1

Lubricante 100% sintético diseñado para motores de competición 2T. Su sofisticada aditivación asegura la eliminación de residuos, vida y rendimiento de las bujías y evita el desgaste. Perfecta lubricación de las piezas que giran muy revolucionadas.



Descripción	Referencia UNIDAD	P.V.P. UNIDAD
GRO Racing-1 1L API TC+ JASO FD	GR20381	19,23

Referencia CAJA	Unidades CAJA
GR20381B	12

OFF ROAD 1

Lubricante 100% sintético diseñado para motores de competición 2T. Su sofisticada aditivación asegura la eliminación de residuos, vida y rendimiento de las bujías y evita el desgaste. Perfecta lubricación de las piezas que giran muy revolucionadas.



Descripción	Referencia UNIDAD	P.V.P. UNIDAD
GRO Off-Road-1 1L API TC+ JASO FD	GR20482	19,23

Referencia CAJA	Unidades CAJA
GR20482B	12

SYNT 7

Lubricante de bases sintéticas para motores de 2T de altas prestaciones. Especial aditivación que reduce la fricción, evita formación de humos y depósitos carbonosos, alarga la vida de las bujías, aumenta la refrigeración y rendimiento del motor.



Descripción	Referencia UNIDAD	P.V.P. UNIDAD
GRO Synt-7 1L API TC+ JASO FD	GR20781	10,52
GRO Synt-7 50L API TC+ JASO FD	GR20743	467,11
GRO Synt-7 208L API TC+ JASO FD	GR20733	1.547,65

Referencia CAJA	Unidades CAJA
GR20781B	12

SCOOTER OIL 2T

Nueva fórmula adaptada a la nueva generación de scooters y motos urbanas de mediana y pequeña cilindrada con sistema pre-mezcla o depósito separado. Mínima formación de humos y depósitos carbonosos, alarga la vida de las bujías.



Descripción	Referencia UNIDAD	P.V.P. UNIDAD
GRO Scooter Oil 2T 1L API TC JASO FC	GR20981	8,45
GRO Scooter Oil 2T 50L API TC JASO FC	GR20943	325,47
GRO Scooter Oil 2T 208L API TC JASO FC	GR20933	1.072,27

Referencia CAJA	Unidades CAJA
GR20981B	12

MOPED OIL

Lubricante de bases sintéticas para motores 2T de altas prestaciones. Especial aditivación que reduce la fricción, evita la formación de humos y depósitos carbonosos, alarga la vida de las bujías, aumenta la refrigeración y rendimiento del motor.



Descripción	Referencia UNIDAD	P.V.P. UNIDAD
GRO Moped Oil 125ml API TC JASO FC	GR20891	1,49

Referencia CAJA	Unidades CAJA
GR20891B	192

UNIVERSAL 2T

Lubricante formulado para motores 2 tiempos, de engrase separado o pre-mezcla, que proporciona una película de extraordinaria resistencia que protege los pistones. Ciclomotores, motosierras, motocoltores, generadores, compresores, maquinaria de jardinería.



Descripción	Referencia UNIDAD	P.V.P. UNIDAD
GRO Universal 2T 1L API TC JASO FC	GR21582	6,75
GRO Universal 2T 5L API TC JASO FC	GR21573	25,97

Referencia CAJA	Unidades CAJA
GR21582B	12
GR21573B	4



Aceite motor 4 tiempos

GLOBAL RACING 5W40 / 10W30 / 10W50

Lubricante formulado con exclusivas bases 100% sintéticas de altas prestaciones. Supera los requerimientos de los motores de 4T que trabajan normalmente a altas revoluciones.

Descripción	Referencia UNIDAD	P.V.P. UNIDAD	Referencia CAJA	Unidades CAJA
GRO Global Racing 5W40 1L JASO MA2 API SL	GR06481	10,69	GR06481B	12
GRO Global Racing 5W40 50L JASO MA2 API SL	GR06443	393,95		
GRO Global Racing 5W40 208L JASO MA2 API SL	GR06433	1.435,10		
GRO Global Racing 10W30 1L JASO MA2 API SL	GR07381	16,56	GR07381B	12
GRO Global Racing 10W30 4L JASO MA2 API SL	GR07376	60,20	GR07376B	4
GRO Global Racing 10W30 50L JASO MA2 API SL	GR07344	626,13		
GRO Global Racing 10W30 208L JASO MA2 API SL	GR07333	2.110,94		
GRO Global Racing 10W50 1L JASO MA2 API SL	GR07481	15,93	GR07481B	12
GRO Global Racing 10W50 4L JASO MA2 API SL	GR07476	57,89	GR07476B	4
GRO Global Racing 10W50 50L JASO MA2 API SL	GR07443	602,05		
GRO Global Racing 10W50 208L JASO MA2 API SL	GR07433	2.029,78		



100% sintéticos



100% sintético

GLOBAL SCOOTER 5W40

Lubricante 100% sintético y de altas prestaciones SAE 5W40, recomendado para moto scooter 4T apto para utilización en carretera como en vías urbanas. Formulado para todo tipo de situaciones y climatología. Satisface especificaciones de motores del grupo Piaggio.

Descripción	Referencia UNIDAD	P.V.P. UNIDAD	Referencia CAJA	Unidades CAJA
GRO Global Scooter 4T 5W40 1L API SN	GR03285	8,92	GR03285B	12
GRO Global Scooter 4T 5W40 50L API SN	GR03244	355,31		
GRO Global Scooter 4T 5W40 208L API SN	GR03234	1.314,54		

GLOBAL SMART 10W40 / 15W50

Lubricante sintético de altas prestaciones formulado para ofrecer la máxima protección y eficiencia en motores de 4T. Diseñado para cumplir todos los requerimientos de los fabricantes de motores refrigerados por aire o agua.

Descripción	Referencia UNIDAD	P.V.P. UNIDAD	Referencia CAJA	Unidades CAJA
GRO Global Smart 10W40 1L JASO MA2 API SL	GR01881	9,23	GR01881B	12
GRO Global Smart 10W40 4L JASO MA2 API SL	GR01876	30,81	BGR01876	4
GRO Global Smart 10W40 50L JASO MA2 API SL	GR01843	324,56		
GRO Global Smart 10W40 208L JASO MA2 API SL	GR01833	1.256,70		
GRO Global Smart 10W40 1000L JASO MA2 API SL	GR01802	5.254,28		
GRO Global Smart 15W50 1L JASO MA2 API SJ	GR21883	8,95	GR21883B	12
GRO Global Smart 15W50 4L JASO MA2 API SJ	GR21876	29,96	GR21876B	4
GRO Global Smart 15W50 50L JASO MA2 API SJ	GR21843	319,53		
GRO Global Smart 15W50 208L JASO MA2 API SJ	GR21833	1.124,88		
GRO Global Smart 15W50 1000L JASO MA2 API SJ	GR21802	4.877,43		





Aceite motor 4 tiempos

GLOBAL SCOOTER 10W40

Lubricante base sintética y de altas prestaciones SAE 10W40, recomendado para moto scooter 4T apto para utilización en carretera como en vías urbanas. Formulado para todo tipo de situaciones y climatología.



Descripción	Referencia UNIDAD	P.V.P. UNIDAD	Referencia CAJA	Unidades CAJA
GRO Global Scooter 4T 10W40 1L API SL	GR05682	7,20	GR05682B	12
GRO Global Scooter 4T 10W40 50L API SL	GR05643	284,34		
GRO Global Scooter 4T 10W40 208L API SL	GR05634	1.014,73		



GLOBAL SPIRIT 20W50

Lubricante formulado para ofrecer la máxima protección y eficiencia en motores de 4T. Diseñado para cumplir todos los requerimientos de los fabricantes de motores refrigerados por aire o agua.

Descripción	Referencia UNIDAD	P.V.P. UNIDAD	Referencia CAJA	Unidades CAJA
GRO Global Spirit 20W50 1L JASO MA2 API SJ	GR02186	7,41	GR02186B	12
GRO Global Spirit 20W50 4L JASO MA2 API SJ	GR02166	26,77	GR02166B	4
GRO Global Spirit 20W50 50L JASO MA2 API SJ	GR02144	298,20		
GRO Global Spirit 20W50 208L JASO MA2 API SJ	GR02134	1.054,68		



Aceite para horquillas

FORK FLUID 2,5W / 5W / 7,5W / 10W / 15W / 20W

Lubricante sintético para horquillas diseñado para atender las demandas de los sistemas modernos de suspensión de largos recorridos. El exclusivo aditivo utilizado protege las juntas prolongando la vida de las mismas y reduciendo las fugas.

Descripción	Referencia UNIDAD	P.V.P. UNIDAD	Referencia CAJA	Unidades CAJA
GRO Fork Fluid 2,5W 1L SAE 2,5	GR26081	10,80	GR26081B	12
GRO Fork Fluid 2,5W 20L SAE 2,5	GR26053	185,00		
GRO Fork Fluid 5W 1L SAE 5	GR26181	10,80	GR26181B	12
GRO Fork Fluid 5W 20L SAE 5	GR26153	185,00		
GRO Fork Fluid 7,5W 1L SAE 7,5	GR26681	10,80	GR26681B	12
GRO Fork Fluid 7,5W 20L SAE 7,5	GR26653	185,00		
GRO Fork Fluid 10W 1L SAE 10	GR26281	10,80	GR26281B	12
GRO Fork Fluid 10W 20L SAE 10	GR26253	185,00		
GRO Fork Fluid 15W 1L SAE 15	GR26481	10,80	GR26481B	12
GRO Fork Fluid 20W 20L SAE 20	GR26381	10,80	GR26381B	12





Aceites para cajas de cambio y transmisiones

GEAR EXTREM 75W

Lubricante 100% sintético de competición para transmisiones y cajas de cambio con embrague húmedo. Baja viscosidad para una máxima lubricación en las condiciones más severas de uso. Especialmente diseñado para cajas de cambio de Gas Gas y Ossa.



Descripción	Referencia UNIDAD	P.V.P. UNIDAD	Referencia CAJA	Unidades CAJA
GRO Gear Extrem 75W 1L API GL-5	GR39481	17,61	GR39481B	12
GRO Gear Extrem 75W 50L API GL-5	GR39443	645,43		

GEAR TRANS 10W40

Lubricante sintético de altas prestaciones para cajas de cambio con embrague húmedo. Con aditivos especiales para obtener una baja viscosidad y elevada resistencia a altas temperaturas para asegurar un embrague y cambios de velocidades suaves y precisos.



Descripción	Referencia UNIDAD	P.V.P. UNIDAD	Referencia CAJA	Unidades CAJA
GRO Gear Trans 10W40 1L API GL-5	GR35881	10,40	GR35881B	12
GRO Gear Trans 10W40 50L API GL-5	GR35843	398,60		

GEAR TRANS 85W140

Lubricante de altas prestaciones formulado para grupo helicoidal y transmisiones por cardan. Formulado con aditivos de extrema presión que absorben las fuertes cargas de impacto frecuentes en la transmisión durante la aceleración y desaceleración conllevando a una transmisión de potencia más eficaz y una vida más larga.



Descripción	Referencia UNIDAD	P.V.P. UNIDAD	Referencia CAJA	Unidades CAJA
GRO Gear Trans 85W140 1L API GL-5	GR38281	10,65	GR38281B	12

GEAR SYNT 70W90



Descripción	Referencia UNIDAD	P.V.P. UNIDAD	Referencia CAJA	Unidades CAJA
Gear SYNT 70W90 LS 1L API GL-4 / GL-5	GR38681	26,48	GR38681B	12
Gear SYNT 70W90 LS 20L API GL-4 / GL-5	GR38653	366,45		
Gear SYNT 70W90 LS 208L API GL-4 / GL-5	GR38633	3.452,97		

GEAR TRANS 80W90



Descripción	Referencia UNIDAD	P.V.P. UNIDAD	Referencia CAJA	Unidades CAJA
Gear Trans 80W90 1L API GL-4 / GL-5	GR38182	9,80	GR38182B	12
Gear Trans 80W90 20L API GL-4 / GL-5	GR38152	179,34		

Anticongelante long time GCC 10% 30% 50%

Líquido anticongelante de altas prestaciones para toda clase de circuitos de refrigeración. Uso permanente todo el año, preparado para soportar temperaturas de -4°C, -18°C, -35°C. Punto de ebullición de 127°C. Fabricado bajo normas UNE 26.361.88. Contiene antiespumante, antioxidante y anticorrosivo para metales. Contiene Etilenglicol.

Descripción	Referencia UNIDAD	P.V.P. UNIDAD	Referencia CAJA	Unidades CAJA
GCC-10% Long Time - Verde -4°C 5L	GR11073	14,50	GR11073B	4
GCC-30% Long Time - Verde -18°C 1L	GR12281	5,40	GR12281B	20
GCC-30% Long Time - Verde -18°C 5L	GR12273	18,40	GR12273B	4
GCC-30% Long Time - Verde -18°C 200L	GR12233	804,98		
GCC-30% Long Time - Verde -18°C 1000L	GR12202	3.536,85		
GCC-30% Long Time - Verde -18°C 5L	GR12473	18,40	GR12473B	4
GCC-50% Long Time - Verde -35°C 5L	GR12673	25,50	GR12673B	4
GCC-50% Long Time - Verde -35°C 25L	GR12656	118,60		
GCC-50% Long Time - Verde -35°C 200L	GR12633	981,78		
GCC-50% Long Time - Verde -35°C 1000L	GR12602	4.750,00		
GCC-50% Long Time - Verde -35°C 5L	GR12873	25,50	GR12873B	4
GCC-50% Long Time - Verde -35°C 1000L	GR12802	4.750,00		
GCC-50% Long Time - Verde -35°C 5L	GR12773	25,50	GR12773B	4
GCC-50% Long Time - Verde -35°C 5L	GR12973	25,50	GR12973B	4
Anticongelante Puro L.T. - Amarillo 25L	GR10031	235,00		
Anticongelante Puro L.T. - Amarillo 200L	GR10033	1.890,00		
Anticongelante Puro L.T. - Amarillo 1000L	GR10002	9.050,00		



Brake fluid DOT 4 / DOT 5.1

Fluido sintético para sistemas de freno de disco o tambor, y mandos de embragues. Particularmente recomendado por su elevado punto de ebullición, para turismos, motocicletas, camiones, autocares, maquinaria obras públicas.



Descripción	Referencia UNIDAD	P.V.P. UNIDAD	Referencia CAJA	Unidades CAJA
Brake Fluid DOT 5.1 500ml	GR30386	16,96	GR30386B	10
Brake Fluid DOT-4 500ml	GR30186	12,36	GR30186B	10

Global white TF2

Grasa compleja multifuncional de larga duración. Adecuada para lubricar cualquier punto que esté en contacto con agua, agua salada o vapor; de gran poder adherente proporciona gran estanqueidad y lubricación.



Descripción	Referencia UNIDAD	P.V.P. UNIDAD	Referencia CAJA	Unidades CAJA
Global White TF-2 200g. NLGI 2	GR51099	10,14	GR51099B	25

Filter cleaner

Clean filter es un limpiador de filtros de aire especialmente formulado para todo tipo de filtros de aire de espuma, de baja agresividad para espuma y gomas de filtro. Elimina residuos de aceite, barro y tierras mejorando la filtración y sin dañar la capa porosa del filtro. Una vez limpio y seco se recomienda la utilización de foam filter oil.



Descripción	Referencia UNIDAD	P.V.P. UNIDAD	Referencia CAJA	Unidades CAJA
Filter Cleaner 5L	GR73373	40,41	GR73373B	4
Filter Cleaner 20L	GR73353	158,64		

Foam filter spray Foam filter oil

Protege el filtro del agua, polvo, arenillas y suciedad. En los filtros nuevos, empapar bien y escurrir. Para mantenimiento de filtros usados, limpiar bien la suciedad con filter cleaner; dejar secar bien y aplicar foam filter.



Descripción	Referencia UNIDAD	P.V.P. UNIDAD	Referencia CAJA	Unidades CAJA
Foam Filter Spray 500ml	GR91298	8,00	GR91298B	12
Foam Filter Oil 1L	GR91281	11,40	GR91281B	12

Chain lube / Chain lube dry

Lubricante de alta adhesividad y poder de penetración especialmente formulado para cadenas de motocicletas con o sin retenes. Resistencia extrema al centrifugado, agua y altas temperaturas.



Descripción	Referencia UNIDAD	P.V.P. UNIDAD	Referencia CAJA	Unidades CAJA
Chain Lube 200ml	GR91199	7,92	GR91199B	24
Chain Lube 500ml	GR91198	12,68	GR91198B	12
Chain Lube Dry 500ml	GR92298	13,28	GR92298B	12

Silicon plus

Potencia el brillo y reaviva los colores de carenados, plásticos, cuadros de mandos, llantas, guardabarros, techos de vinilo y salpicaderos de automóviles y motocicletas. Evita la deposición de polvo e insectos. Repele el agua y la humedad. Aplicar a 30cm de la superficie a tratar.



Descripción	Referencia UNIDAD	P.V.P. UNIDAD	Referencia CAJA	Unidades CAJA
Silicon Plus 500ml	GRO91899	9,94	GRO91899B	12

Contact Cleaner

Spray de alta presión formulado para no dejar residuos. Desengrasa y limpia restos carbonosos, contactos, bujías, carburadores, discos y tambores de frenos, componentes internos del motor, depósitos y guardabarros.



Descripción	Referencia UNIDAD	P.V.P. UNIDAD	Referencia CAJA	Unidades CAJA
Contact Cleaner 500ml	GR91598	8,00	GR91598B	12

GRO Multispray

Aceite disolvente de la herrumbre, de elevada penetración y capacidad lubricante. Protege de la humedad, libera componentes agarrotados y lubrica pequeños mecanismos. Una vez rociado el punto deseado, dejar actuar unos minutos.



Descripción	Referencia UNIDAD	P.V.P. UNIDAD	Referencia CAJA	Unidades CAJA
Miltispray 500ml	GR90799	7,02	GR90799B	12

Air repair GTS 30

El spray indispensable en caso de pinchazo sin desmontar el neumático, permite reparar el pinchazo y continuar circulando hasta el punto más cercano de servicio.



Descripción	Referencia UNIDAD	P.V.P. UNIDAD	Referencia CAJA	Unidades CAJA
GTS-30 Air Repair Spray 200ml	GR91399	6,54	GR91399B	24

Global gel

Crema de manos desengrasante con micro partículas. Desengrasante energético para el lavado y el aseo de manos. Con componentes emulsionantes y emolientes que proporcionan un elevado poder de limpieza dejando las manos suaves. PH neutro.



Descripción	Referencia UNIDAD	P.V.P. UNIDAD	Referencia CAJA	Unidades CAJA
Global Gel 1L	GR80467	12,87	GR80467B	12
Global Gel 10L	GR80446	113,67		

Impnesa: Atención al cliente

Disponemos de varios formatos con los que poder realizar tu pedido, tan sólo elige el que más te convenga ¡nosotros te atenderemos!

Por teléfono:

Nuestro horario de atención telefónica es de lunes a viernes de 9 a 14 horas y de 15 a 19 horas. Disponemos de un equipo de profesionales que atenderán todas tus consultas y solucionaran cualquier problema. ¡Nosotros te atenderemos!

Teléfono de atención: 938 771 550

En nuestra web:

Realiza tu pedido los 365 días del año las 24 horas del día.

Tan simple como entrar en nuestra web, solicitar tu código de cliente (mediante el registro de la misma web) y realizar tu pedido.

Si ya dispones del código de cliente, simplemente entra, elige y disfruta del servicio.

www.impnesa.com

Mail:

¿No te gusta utilizar papel? Entonces no te lo plantees más. Envíanos un e-mail con todos tus datos de cliente, referencias y descripción del producto. Si tenemos cualquier duda nosotros nos ponemos en contacto.

pedidos@impnesa.com

HORARIO RECEPCIÓN Y ENTREGA DE PEDIDOS:

Todos los pedidos están sujetos al servicio de 24h

(48h dependiendo de la zona y fluidez de transporte de vuestra población)

Los pedidos efectuados de 9:00 a 14:00 h. La recogida se realiza a las 15:00 h.

Los pedidos efectuados de 15:00 a 18:00 h. (a partir de las 17:00 h no siempre esta garantizado su envío), se efectuara su recogida a las 18:00 h.

Hasta las 14:00 h. es posible añadir artículos al pedido, nuestra intención es ofrecerle una correcta fluidez en la realización de sus pedidos y un eficiente servicio tanto a nivel logístico y de atención.

CONSULTA CUALQUIER PRODUCTO EN **IMPNESA.COM**

¿Tienes dudas sobre la referencia que hay que pedir? ¿Quieres ver primero el producto que necesitas antes de pasar el pedido?

En Impnesa trabajamos para facilitarte la vida, así que si quieres ver las características, de bielas, fuelles, válvulas, etc... tan solo debes conectarte a nuestra web

www.impnesa.com y buscar en nuestro agilizado menú.

Si ya conoces la referencia del producto y simplemente quieres visualizar la imagen sin perder un minuto, entra en: **www.impnesa.com** e introduce la referencia directamente y aparecerá la imagen.

¿Es lo que buscas? Pues no esperes más, ¡pídelo ya!

Menú de búsqueda por referencia

www.impnesa.com/referencia

ENVÍOS: SERVICIO URGENTE

En Impnesa trabajamos con las más importantes empresas de transportes, asegurando de este modo el máximo de efectividad y rapidez de nuestros envíos. ¡Nosotros nos encargamos de todo!

*Si realizas cualquier pedido antes de las 18.00 horas, lo recibirás en el transcurso del día siguiente (dependiendo de la contratación de servicio y zona).

DEVOLUCIONES:

En caso de que nosotros hayamos enviado un artículo diferente al solicitado por el cliente, asumiremos los gastos generados de la devolución y del envío del material correcto.

Si por el contrario el error es del cliente, este deberá asumir todos los cargos. No se aceptarán devoluciones sin antes ser comunicadas al departamento de atención al cliente. Para realizar cualquier devolución el cliente dispondrá de 30 días hábiles desde la emisión de la factura.

Nota importante: Cualquier producto que sea devuelto y no se encuentre en perfecto estado (inalterado desde su salida, empaquetado incluido), NO será aceptado por nuestra parte.

Garantía: Cada producto de nuestro catálogo dispone de una garantía independiente. En caso de que el cliente deba solicitar la devolución o cambio de un producto bajo la garantía, será preciso ponerse previamente en contacto con el centro de atención al cliente, donde comunicará la incidencia y recibirá una resolución.

FORMAS DE PAGO

Sea cual sea la forma que hayas utilizado para realizar el pedido, nosotros te hacemos llegar el albarán con el importe a abonar antes de poder dar salida al envío.

Existen varias formas de pago:

*Transferencia a nuestra cuenta incluyendo el número de albarán.

Para clientes ubicados en España: **Banco Sabadell ES65 0081 0049 5400 0122 4125**

Para clientes ubicados en Francia: **Societe Generale FR76 30003 01600 00028013823 15**

Para el resto de países (Andorra, Portugal...), Iban: **ES65 0049 1802 0823 1049 0038**

***Contrareembolso:** Si decides utilizar esta forma de pago, nosotros asumimos el coste adicional que supone la contratación del servicio (sólo para clientes profesionales).

***Tarjeta de crédito:** Si realizas el pedido por internet podrás realizar el pago con tu tarjeta, siguiendo los pasos marcados.



Thundra Cross y llanta SS



Ultra Cross y llanta SS



Baja Cross 8 lonas



Holeshoot XCR



**Los mejores neumáticos
y llantas del mercado**



BRONCO

INNOVA

EMIGO

ČZ Chains



PISTONS



PSYCHIC
MIX COMPONENTS

4PLAY

NAMURA
TECHNOLOGIES INC.

XPEED

GALFER



SNOWSPORT
UTILITY FLOW



DEMON
POWERSPORTS



GRO
Global Racing Oil

A Sonic

